

CAGE Code 81205

737 MAX

Airplane Characteristics for Airport Planning

DOCUMENT NUMBER:
D6-38A004

REVISION:
REV H

REVISION DATE:
March 2023

CONTENT OWNER:

Boeing Commercial Airplanes

All revisions to this document must be approved by the content owner before release.

Not Subject to US Export Administration Regulations (EAR), (15 C.F.R. Parts 730-774) or US International Traffic in Arms Regulations (ITAR), (22 C.F.R. Parts 120-130).



Revision Record

Revision Letter	H
Revision Date	March 2023
Changes in This Revision	Section 3.0 737-7 ICAO Aerodrome Reference Code Information
Revision Letter	G
Revision Date	May 2022
Changes in This Revision	Section 2.0 Updated Usable Cargo Volume, Minor Updates Section 6.0 Updated Jet Engine Exhaust Contour Conditions, Inlet Hazard Areas Section 7.0 Updated ACR/PCR Information
Revision Letter	F
Revision Date	January 2021
Changes in This Revision	All Sections 737-8 Increased Gross Weight Section 3.0 Added ICAO Aerodrome Reference Code Information
Revision Letter	E
Revision Date	July 2019
Changes in This Revision	737-10 / BBJ MAX 9: Initial Release All sections
Revision Letter	D
Revision Date	March 2019
Changes in This Revision	737-7 / -8-200: Updated Release All sections
Revision Letter	C
Revision Date	June 2018
Changes in This Revision	BBJ MAX 8: Updated Release All sections
Revision Letter	B
Revision Date	June 2018
Changes in This Revision	737-7: Initial Release 737-9: Updated Release All sections
Revision Letter	A
Revision Date	August 2017
Changes in This Revision	737-8-200 / -9 / BBJ MAX 8: Initial Release 737-8: Updated Release All sections
Revision Letter	New
Revision Date	July 2015
Changes in This Revision	Initial release of 737-8 data. All sections

Table of Contents

1.0	SCOPE AND INTRODUCTION	1-1
1.1	SCOPE	1-1
1.2	INTRODUCTION	1-2
1.3	BRIEF DESCRIPTION OF THE 737 MAX FAMILY OF AIRPLANES	1-3
1.4	CONVERSION FACTORS.....	1-4
2.0	AIRPLANE DESCRIPTION.....	2-1
2.1	GENERAL CHARACTERISTICS	2-1
2.1.1	General Characteristics: Model 737-7	2-2
2.1.2	General Characteristics: Model 737-8	2-3
2.1.3	General Characteristics: Model 737-8-200	2-4
2.1.4	General Characteristics: Model BBJ MAX 8.....	2-5
2.1.5	General Characteristics: Model 737-9	2-6
2.1.6	General Characteristics: Model BBJ MAX 9.....	2-7
2.1.7	General Characteristics: Model 737-10	2-8
2.2	GENERAL DIMENSIONS	2-9
2.2.1	General Dimensions: Model 737-7	2-9
2.2.2	General Dimensions: Model 737-8 / -8-200 / BBJ MAX 8	2-10
2.2.3	General Dimensions: Model 737-9 / BBJ MAX 9	2-11
2.2.4	General Dimensions: Model 737-10	2-12
2.3	GROUND CLEARANCES	2-13
2.3.1	Ground Clearances: Model 737-7	2-13
2.3.2	Ground Clearances: Model 737-8 / -8-200 / BBJ MAX 8	2-14
2.3.3	Ground Clearances: Model 737-9 / BBJ MAX 9	2-15
2.3.4	Ground Clearances: Model 737-10	2-16
2.4	INTERIOR ARRANGEMENTS.....	2-17
2.4.1	Interior Arrangements: Model 737-7	2-17
2.4.2	Interior Arrangements: Model 737-8	2-18
2.4.3	Interior Arrangements: Model 737-8-200	2-19
2.4.4	Interior Arrangements: Model 737-9	2-20
2.4.5	Interior Arrangements: Model 737-10	2-21
2.5	CABIN CROSS SECTIONS	2-22
2.5.1	Cabin Cross-Sections: All Models	2-22
2.6	LOWER CARGO COMPARTMENTS	2-23
2.6.1	Lower Cargo Compartments: All Models.....	2-23
2.6.2	Lower Cargo Compartments: Model BBJ MAX 8	2-24
2.6.3	Lower Cargo Compartments: Model BBJ MAX 9	2-25
2.7	DOOR CLEARANCES.....	2-26
2.7.1	Passenger and Cargo Door Locations: All Models	2-26

2.7.2	Door Clearances - Forward Main Entry Door: All Models	2-27
2.7.3	Door Clearances - Optional Forward Airstairs, Forward Main Entry Door: All Models	2-28
2.7.4	Door Clearances: Sensor and Probe Locations - Forward Cabin Doors: All Models.....	2-29
2.7.5	Door Clearances – Forward Service Door: All Models	2-30
2.7.6	Door Clearances - Aft Entry/Service Door: All Models	2-31
2.7.7	Door Clearances - Lower Deck Cargo Compartments: All Models	2-32
3.0	AIRPLANE PERFORMANCE	3-1
3.1	GENERAL INFORMATION.....	3-1
3.2	PAYLOAD/RANGE FOR LONG RANGE CRUISE	3-2
3.2.1	Payload/Range for Long Range Cruise: Model 737-7	3-2
3.2.2	Payload/Range for Long Range Cruise: Model BBJ MAX 7	3-3
3.2.3	Payload/Range for Long Range Cruise: Model 737-8 / -8-200	3-4
3.2.4	Payload/Range for Long Range Cruise: Model BBJ MAX 8	3-5
3.2.5	Payload/Range for Long Range Cruise: Model 737-9	3-6
3.2.6	Payload/Range for Long Range Cruise: Model BBJ MAX 9	3-7
3.3	FAA/EASA TAKEOFF RUNWAY LENGTH REQUIREMENTS	3-8
3.3.1	FAA/EASA Takeoff Runway Length Requirements - Standard Day, Dry Runway: Model 737-7 (LEAP-1B25 Engine).....	3-8
3.3.2	FAA/EASA Takeoff Runway Length Requirements - Standard Day + 27°F (STD + 15°C), Dry Runway: Model 737-7 (LEAP-1B25 Engine)	3-9
3.3.3	FAA/EASA Takeoff Runway Length Requirements - Standard Day + 45°F (STD + 25°C), Dry Runway: Model 737-7 (LEAP-1B25 Engine)	3-10
3.3.4	FAA/EASA Takeoff Runway Length Requirements - Standard Day + 63°F (STD + 35 °C), Dry Runway: Model 737-7 (LEAP-1B25 Engine)	3-11
3.3.5	FAA/EASA Takeoff Runway Length Requirements - Standard Day, Dry Runway: Model 737-7 (LEAP-1B28B2C Engine)	3-12
3.3.6	FAA/EASA Takeoff Runway Length Requirements - Standard Day + 27°F (STD + 15°C), Dry Runway: Model 737-7 (LEAP-1B28B2C Engine)	3-13
3.3.7	FAA/EASA Takeoff Runway Length Requirements - Standard Day + 45°F (STD + 25°C), Dry Runway: Model 737-7 (LEAP-1B28B2C Engine)	3-14
3.3.8	FAA/EASA Takeoff Runway Length Requirements - Standard Day + 63°F (STD + 35 °C), Dry Runway: Model 737-7 (LEAP-1B28B2C Engine)	3-15
3.3.9	FAA/EASA Takeoff Runway Length Requirements - Standard Day, Dry Runway: Model 737-8 / -8-200 (LEAP-1B25 Engine).....	3-16

3.3.10	FAA/EASA Takeoff Runway Length Requirements - Standard Day + 27°F (STD + 15°C), Dry Runway: Model 737-8 / -8-200 (LEAP-1B25 Engine).....	3-17
3.3.11	FAA/EASA Takeoff Runway Length Requirements - Standard Day + 45°F (STD + 25°C), Dry Runway: Model 737-8 / -8-200 (LEAP-1B25 Engine).....	3-18
3.3.12	FAA/EASA Takeoff Runway Length Requirements - Standard Day + 63°F (STD + 35 °C), Dry Runway: Model 737-8 / -8-200 (LEAP-1B25 Engine).....	3-19
3.3.13	FAA/EASA Takeoff Runway Length Requirements - Standard Day, Dry Runway: Model 737-8 / -8-200 / BBJ MAX 8 (LEAP- 1B28B1 / LEAP-1B28BBJ1 Engines)	3-20
3.3.14	FAA/EASA Takeoff Runway Length Requirements - Standard Day + 27°F (STD + 15°C), Dry Runway: Model 737-8 / -8-200 / BBJ MAX 8 (LEAP-1B28B1 / LEAP-1B28BBJ1 Engines)	3-21
3.3.15	FAA/EASA Takeoff Runway Length Requirements - Standard Day + 45°F (STD + 25°C), Dry Runway: Model 737-8 / -8-200 / BBJ MAX 8 (LEAP-1B28B1 / LEAP-1B28BBJ1 Engines)	3-22
3.3.16	FAA/EASA Takeoff Runway Length Requirements - Standard Day + 63°F (STD + 35 °C), Dry Runway: Model 737-8 / -8-200 / BBJ MAX 8 (LEAP-1B28B1 / LEAP-1B28BBJ1 Engines)	3-23
3.3.17	FAA/EASA Takeoff Runway Length Requirements - Standard Day, Dry Runway: Model 737-9 (LEAP-1B27 Engine).....	3-24
3.3.18	FAA/EASA Takeoff Runway Length Requirements - Standard Day + 27°F (STD + 15°C), Dry Runway: Model 737-9 (LEAP- 1B27 Engine)	3-25
3.3.19	FAA/EASA Takeoff Runway Length Requirements - Standard Day + 45°F (STD + 25°C), Dry Runway: Model 737-9 (LEAP- 1B27 Engine)	3-26
3.3.20	FAA/EASA Takeoff Runway Length Requirements - Standard Day + 63°F (STD + 35 °C), Dry Runway: Model 737-9 (LEAP- 1B27 Engine)	3-27
3.3.21	FAA/EASA Takeoff Runway Length Requirements – Standard Day, Dry Runway: Model 737-9 / BBJ MAX 9 (LEAP-1B28 / LEAP-1B28BBJ1 Engines).....	3-28
3.3.22	FAA/EASA Takeoff Runway Length Requirements - Standard Day + 27°F (STD + 15°C), Dry Runway: Model 737-9 / BBJ MAX 9 (LEAP-1B28 / LEAP-1B28BBJ1 Engines).....	3-29
3.3.23	FAA/EASA Takeoff Runway Length Requirements - Standard Day + 45°F (STD + 25°C), Dry Runway: Model 737-9 / BBJ MAX 9 (LEAP-1B28 / LEAP-1B28BBJ1 Engines).....	3-30
3.3.24	FAA/EASA Takeoff Runway Length Requirements - Standard Day + 63°F (STD + 35 °C), Dry Runway: Model 737-9 / BBJ MAX 9 (LEAP-1B28 / LEAP-1B28BBJ1 Engines).....	3-31

3.3.25	FAA/EASA Takeoff Runway Length Requirements: Model 737-10.....	3-32
3.3.26	ICAO Aerodrome Reference Code – All Models	3-33
3.4	FAA/EASA LANDING RUNWAY LENGTH REQUIREMENTS.....	3-34
3.4.1	FAA/EASA Landing Runway Length Requirements - Flaps 15: Model 737-7 / BBJ MAX 7.....	3-34
3.4.2	FAA/EASA Landing Runway Length Requirements - Flaps 30: Model 737-7 / BBJ MAX 7.....	3-35
3.4.3	FAA/EASA Landing Runway Length Requirements - Flaps 40: Model 737-7 / BBJ MAX 7.....	3-36
3.4.4	FAA/EASA Landing Runway Length Requirements - Flaps 15: Model 737-8 / -8-200 / BBJ MAX 8.....	3-37
3.4.5	FAA/EASA Landing Runway Length Requirements - Flaps 30: Model 737-8 / -8-200 / BBJ MAX 8.....	3-38
3.4.6	FAA/EASA Landing Runway Length Requirements - Flaps 40: Model 737-8 / -8-200 / BBJ MAX 8.....	3-39
3.4.7	FAA/EASA Landing Runway Length Requirements - Flaps 15: Model 737-9 / BBJ MAX 9.....	3-40
3.4.8	FAA/EASA Landing Runway Length Requirements - Flaps 30: Model 737-9 / BBJ MAX 9.....	3-41
3.4.9	FAA/EASA Landing Runway Length Requirements - Flaps 40: Model 737-9 / BBJ MAX 9.....	3-42
3.4.10	FAA/EASA Landing Runway Length Requirements: Model 737-10.....	3-43
4.0	GROUND MANEUVERING	4-1
4.1	GENERAL INFORMATION.....	4-1
4.2	TURNING RADII	4-2
4.2.1	Turning Radii – No Slip Angle: Model 737-7	4-2
4.2.2	Turning Radii – No Slip Angle: Model 737-8 / -8-200 / BBJ MAX 8	4-3
4.2.3	Turning Radii – No Slip Angle: Model 737-9 / BBJ MAX 9	4-4
4.2.4	Turning Radii – No Slip Angle: Model 737-10	4-5
4.3	CLEARANCE RADII	4-6
4.3.1	Clearance Radii – 3° and 5° Slip Angles: All Models	4-6
4.4	VISIBILITY FROM COCKPIT IN STATIC POSITION: ALL MODELS.....	4-7
4.5	RUNWAY AND TAXIWAY TURNPATHS.....	4-8
4.5.1	Runway and Taxiway Turnpaths - Runway-to-Taxiway, More Than 90-Degree Turn: Model 737-7.....	4-8
4.5.2	Runway and Taxiway Turnpaths - Runway-to-Taxiway, 90-Degree Turn: Model 737-7.....	4-9

4.5.3	Runway and Taxiway Turnpaths - Taxiway-to-Taxiway, 90-Degree Turn: Model 737-7.....	4-10
4.5.4	Runway and Taxiway Turnpaths - Runway-to-Taxiway, More Than 90-Degree Turn: Model 737-8 / -8-200 / BBJ MAX 8.....	4-11
4.5.5	Runway and Taxiway Turnpaths - Runway-to-Taxiway, 90-Degree Turn: Model 737-8 / -8-200 / BBJ MAX 8.....	4-12
4.5.6	Runway and Taxiway Turnpaths - Taxiway-to-Taxiway, 90-Degree Turn: Model 737-8 / -8-200 / BBJ MAX 8.....	4-13
4.5.7	Runway and Taxiway Turnpaths - Runway-to-Taxiway, More Than 90-Degree Turn: Model 737-9 / BBJ MAX 9.....	4-14
4.5.8	Runway and Taxiway Turnpaths - Runway-to-Taxiway, 90-Degree Turn: Model 737-9 / BBJ MAX 9.....	4-15
4.5.9	Runway and Taxiway Turnpaths - Taxiway-to-Taxiway, 90-Degree Turn: Model 737-9 / BBJ MAX 9.....	4-16
4.5.10	Runway and Taxiway Turnpaths - Runway-to-Taxiway, More Than 90-Degree Turn: Model 737-10.....	4-17
4.5.11	Runway and Taxiway Turnpaths - Runway-to-Taxiway, 90-Degree Turn: Model 737-10.....	4-18
4.5.12	Runway and Taxiway Turnpaths - Taxiway-to-Taxiway, 90-Degree Turn: Model 737-10.....	4-19
4.6	RUNWAY HOLDING BAY: MODEL 737, ALL MODELS.....	4-20
5.0	TERMINAL SERVICING.....	5-1
5.1	AIRPLANE SERVICING ARRANGEMENT - TYPICAL TURNAROUND.....	5-2
5.1.1	Airplane Servicing Arrangement - Typical Turnaround: Model 737-7.....	5-2
5.1.2	Airplane Servicing Arrangement - Typical Turnaround: Model 737-8 / -8-200 / BBJ MAX 8.....	5-3
5.1.3	Airplane Servicing Arrangement - Typical Turnaround: Model 737-9 / BBJ MAX 9.....	5-4
5.1.4	Airplane Servicing Arrangement - Typical Turnaround: Model 737-10.....	5-5
5.1.5	Airplane Servicing Arrangement - Typical En Route: All Models.....	5-6
5.2	TERMINAL OPERATIONS - TURNAROUND STATION.....	5-7
5.2.1	Terminal Operations – Turnaround Station: Model 737-7.....	5-7
5.2.2	Terminal Operations – Turnaround Station: Model 737-8.....	5-8
5.2.3	Terminal Operations – Turnaround Station: Model 737-8-200.....	5-9
5.2.4	Terminal Operations – Turnaround Station: Model 737-9.....	5-10
5.2.5	Terminal Operations – Turnaround Station: Model 737-10.....	5-11
5.3	TERMINAL OPERATIONS - EN ROUTE STATION.....	5-12
5.3.1	Terminal Operations - En Route Station: Model 737-7.....	5-12
5.3.2	Terminal Operations - En Route Station: Model 737-8.....	5-13

5.3.3	Terminal Operations - En Route Station: Model 737-8-200.....	5-14
5.3.4	Terminal Operations - En Route Station: Model 737-9	5-15
5.3.5	Terminal Operations - En Route Station: Model 737-10	5-16
5.4	GROUND SERVICING CONNECTIONS.....	5-17
5.4.1	Ground Service Connections - Locations: Model 737-7.....	5-17
5.4.2	Ground Service Connections - Locations: Model 737-8 /-8-200 / BBJ MAX 8.....	5-18
5.4.3	Ground Service Connections - Locations: Model 737-9 / BBJ MAX 9	5-19
5.4.4	Ground Service Connections - Locations: Model 737-10.....	5-20
5.4.5	Ground Servicing Connections and Capacities: All Models.....	5-21
5.5	ENGINE STARTING PNEUMATIC REQUIREMENTS	5-22
5.5.1	Engine Start Pneumatic Requirements - Sea Level: All Models	5-22
5.6	GROUND PNEUMATIC POWER REQUIREMENTS	5-23
5.6.1	Ground Pneumatic Power Requirements - Heating/Cooling: All Models.....	5-23
5.7	CONDITIONED AIR REQUIREMENTS	5-24
5.7.1	Conditioned Air Flow Requirements: All Models	5-24
5.8	GROUND TOWING REQUIREMENTS	5-25
5.8.1	Ground Towing Requirements - English Units: All Models	5-25
5.8.2	Ground Towing Requirements - Metric Units: All Models	5-26
6.0	JET ENGINE WAKE AND NOISE DATA	6-1
6.1	JET ENGINE EXHAUST VELOCITIES AND TEMPERATURES	6-1
6.1.1	Jet Engine Exhaust Velocity Contours - Idle Thrust: All Models.....	6-2
6.1.2	Jet Engine Exhaust Velocity Contours - Breakaway Thrust / 0% Slope / One Engine / MLW: Model 737-7.....	6-3
6.1.3	Jet Engine Exhaust Velocity Contours - Breakaway Thrust / 0% Slope / One Engine / MTW: Model 737-7.....	6-4
6.1.4	Jet Engine Exhaust Velocity Contours - Breakaway Thrust / 0% Slope / Both Engines / MTW: Model 737-7	6-5
6.1.5	Jet Engine Exhaust Velocity Contours - Breakaway Thrust / 1% Slope / Both Engines / MTW: Model 737-7	6-6
6.1.6	Jet Engine Exhaust Velocity Contours - Breakaway Thrust / 0% Slope / One Engine / MLW: Model 737-8 / -8-200 / BBJ MAX 8.....	6-7
6.1.7	Jet Engine Exhaust Velocity Contours - Breakaway Thrust / 0% Slope / One Engine / MTW: Model 737-8 / -8-200 / BBJ MAX 8.....	6-8
6.1.8	Jet Engine Exhaust Velocity Contours - Breakaway Thrust / 0% Slope / Both Engines / MTW: Model 737-8 / -8-200 / BBJ MAX 8.....	6-9
6.1.9	Jet Engine Exhaust Velocity Contours - Breakaway Thrust / 1% Slope / Both Engines / MTW: Model 737-8 / -8-200 / BBJ MAX 8.....	6-10

737-10 INFORMATION IS PRELIMINARY

6.1.10	Jet Engine Exhaust Velocity Contours - Breakaway Thrust / 0% Slope / One Engine / MTW: Model 737-9 / BBJ MAX 9	6-11
6.1.11	Jet Engine Exhaust Velocity Contours - Breakaway Thrust / 0% Slope / Both Engines / MLW: Model 737-9 / BBJ MAX 9.....	6-12
6.1.12	Jet Engine Exhaust Velocity Contours - Breakaway Thrust / 0% Slope / Both Engines / MTW: Model 737-9 / BBJ MAX 9.....	6-13
6.1.13	Jet Engine Exhaust Velocity Contours - Breakaway Thrust / 1% Slope / Both Engines / MTW: Model 737-9 / BBJ MAX 9.....	6-14
6.1.14	Jet Engine Exhaust Velocity Contours – Breakaway Thrust / 0% Slope / One Engine / MLW: Model 737-10.....	6-15
6.1.15	Jet Engine Exhaust Velocity Contours – Breakaway Thrust / 0% Slope / One Engine / MTW: Model 737-10.....	6-16
6.1.16	Jet Engine Exhaust Velocity Contours – Breakaway Thrust / 0% Slope / Both Engines / MTW: Model 737-10	6-17
6.1.17	Jet Engine Exhaust Velocity Contours – Breakaway Thrust / 1% Slope / Both Engines / MTW: Model 737-10	6-18
6.1.18	Jet Engine Exhaust Velocity Contours – Takeoff Thrust: All Models.....	6-19
6.1.19	Jet Engine Exhaust Temperature Contours – Idle/Breakaway Thrust: All Models	6-20
6.1.20	Jet Engine Exhaust Temperature Contours – Takeoff Thrust: Model 737-7	6-21
6.1.21	Jet Engine Exhaust Temperature Contours – Takeoff Thrust: Model 737-8 / -8-200 / BBJ MAX 8	6-22
6.1.22	Jet Engine Exhaust Temperature Contours – Takeoff Thrust: Model 737-9 / BBJ MAX 9.....	6-23
6.1.23	Inlet Hazard Areas: All Models	6-24
6.2	AIRPORT AND COMMUNITY NOISE.....	6-25
7.0	PAVEMENT DATA	7-1
7.1	GENERAL INFORMATION.....	7-1
7.2	LANDING GEAR FOOTPRINT	7-4
7.2.1	Landing Gear Footprint: All Models.....	7-4
7.3	MAXIMUM PAVEMENT LOADS.....	7-5
7.3.1	Maximum Pavement Loads: All Models	7-5
7.4	LANDING GEAR LOADING ON PAVEMENT	7-6
7.4.1	Landing Gear Loading on Pavement: Model 737-7.....	7-6
7.4.2	Landing Gear Loading on Pavement: Model 737-8 / -8-200 / BBJ MAX 8	7-7
7.4.3	Landing Gear Loading on Pavement: Model 737-9.....	7-8
7.4.4	Landing Gear Loading on Pavement: Model 737-10.....	7-9
7.5	FLEXIBLE PAVEMENT REQUIREMENTS - FAA DESIGN METHOD	7-10

7.6	FLEXIBLE PAVEMENT REQUIREMENTS - LCN CONVERSION.....	7-11
7.7	RIGID PAVEMENT REQUIREMENTS - PORTLAND CEMENT ASSOCIATION DESIGN METHOD	7-12
7.8	RIGID PAVEMENT REQUIREMENTS - LCN CONVERSION	7-13
7.9	RIGID PAVEMENT REQUIREMENTS - FAA DESIGN METHOD	7-14
7.10	ACN/PCN REPORTING SYSTEM - FLEXIBLE AND RIGID PAVEMENTS	7-15
7.10.1	Aircraft Classification Number - Flexible Pavement: Model 737-7	7-16
7.10.2	Aircraft Classification Number - Flexible Pavement: Model 737-8 / -8-200 / BBJ MAX 8.....	7-17
7.10.3	Aircraft Classification Number - Flexible Pavement: Model 737-9 / BBJ MAX 9	7-18
7.10.4	Aircraft Classification Number - Flexible Pavement: Model 737- 10.....	7-19
7.10.5	Aircraft Classification Number - Rigid Pavement: Model 737-7	7-20
7.10.6	Aircraft Classification Number - Rigid Pavement: Model 737-8 / - 8-200 / BBJ MAX 8	7-1
7.10.7	Aircraft Classification Number - Rigid Pavement: Model 737-9 / BBJ MAX 9.....	7-2
7.10.8	Aircraft Classification Number - Rigid Pavement: Model 737-10	7-3
7.11	ACR/PCR REPORTING SYSTEM - FLEXIBLE AND RIGID PAVEMENTS	7-4
7.11.1	Aircraft Classification Rating - Flexible Pavement: Model 737-7	7-5
7.11.2	Aircraft Classification Rating - Flexible Pavement: Model 737-8 / -8-200 / BBJ MAX 8.....	7-6
7.11.3	Aircraft Classification Rating - Flexible Pavement: Model 737-9 / BBJ MAX 9.....	7-7
7.11.4	Aircraft Classification Rating - Flexible Pavement: Model 737-10	7-8
7.11.5	Aircraft Classification Rating - Rigid Pavement: Model 737-7.....	7-9
7.11.6	Aircraft Classification Rating - Rigid Pavement: Model 737-8 / - 8-200 / BBJ MAX 8	7-1
7.11.7	Aircraft Classification Rating - Rigid Pavement: Model 737-9 / BBJ MAX 9.....	7-2
7.11.8	Aircraft Classification Rating - Rigid Pavement: Model 737-10.....	7-3
8.0	FUTURE 737 DERIVATIVE AIRPLANES.....	8-1
9.0	SCALED 737 DRAWINGS	9-1
9.1	MODEL 737-7.....	9-2
9.1.1	Scaled Drawings – 1:500: Model 737-7.....	9-2
9.2	MODEL 737-8.....	9-3
9.2.1	Scaled Drawings – 1:500: Model 737-8.....	9-3
9.3	MODEL 737-9.....	9-4

737-10 INFORMATION IS PRELIMINARY

9.3.1 Scaled Drawings – 1:500: Model 737-9..... 9-4
9.4 MODEL 737-10..... 9-5
9.4.1 Scaled Drawings – 1:500: Model 737-10..... 9-5

1.0 SCOPE AND INTRODUCTION

1.1 SCOPE

This document provides, in a standardized format, airplane characteristics data for general airport planning. Since operational practices vary among airlines, specific data should be coordinated with the using airlines prior to facility design. Boeing Commercial Airplanes should be contacted for any additional information required.

Content of the document reflects the results of a coordinated effort by representatives from the following organizations:

- Aerospace Industries Association
- Airports Council International - North America
- Air Transport Association of America
- International Air Transport Association

The airport planner may also want to consider the information presented in the "Commercial Aircraft Design Characteristics - Trends and Growth Projections," for long range planning needs and can be accessed via the following website:

<http://www.boeing.com/airports>

The document is updated periodically and represents the coordinated efforts of the following organizations regarding future aircraft growth trends.

- International Coordinating Council of Aerospace Industries Associations
- Airports Council International - North America
- Air Transport Association of America
- International Air Transport Association

1.2 INTRODUCTION

This document conforms to NAS 3601. It provides characteristics of the Boeing Model 737 MAX airplane for airport planners and operators, airlines, architectural and engineering consultant organizations, and other interested industry agencies. Airplane changes and available options may alter model characteristics. Data contained herein is generic in scope and not customer-specific.

For additional information contact:

Boeing Commercial Airplanes
2201 Seal Beach Blvd. M/C: 110-SB02
Seal Beach, CA 90740-1515
U.S.A.

Attention: Manager, Airport Operations Engineering

Email: AirportCompatibility@boeing.com

1.3 BRIEF DESCRIPTION OF THE 737 MAX FAMILY OF AIRPLANES

The 737 MAX is the latest series of derivative airplanes in the 737 family of airplanes. The 737 MAX airplanes include 737-7, 737-8, 737-8-200, 737-9, 737-10, and the Business Jet versions.

The 737 MAX series airplanes have improved fuel efficiency, increased payload or range, and reduced emissions and noise. The 737 MAX incorporates an all new CFM LEAP-1B engine for improved fuel-efficiency and reduced community noise. One of the characteristics new to the 737 MAX family which improves operational efficiency is the new Advanced Technology (AT) winglet with a distinctive dual-feather configuration to improve aerodynamics.

The 737 MAX family remains a Federal Aviation Administration (FAA) Airplane Design Group III and International Civil Aviation Organization (ICAO) Aerodrome Reference Code Letter C aircraft.

1.4 CONVERSION FACTORS

The data in this manual is provided in both English and Metric units. Unless otherwise stated, the conversions listed below are used throughout this manual.

MULTIPLY	BY	TO OBTAIN
Pounds	0.45359237	Kilograms
U.S. Gallons	3.78541180	Liters
Inches	2.54000000	Centimeters
Feet	0.30480000	Meters

When totals or summations are required the English values are summed separately from the Metric values. Differences may occur when comparing the English total with metric totals due to rounding.

All metric values are converted from English values. When using the conversion factors in this manual, all resultants will be rounded except when the value is a weight limitation. For minimum or maximum weight limitations the resultant metric values will be rounded up or truncated, whichever is more conservative.

2.0 AIRPLANE DESCRIPTION

2.1 GENERAL CHARACTERISTICS

Maximum Design Taxi Weight (MTW). Maximum weight for ground maneuver as limited by aircraft strength and airworthiness requirements. (It includes weight of taxi and run-up fuel.)

Maximum Design Takeoff Weight (MTOW). Maximum weight for takeoff as limited by aircraft strength and airworthiness requirements. (This is the maximum weight at start of the takeoff run.)

Maximum Design Landing Weight (MLW). Maximum weight for landing as limited by aircraft strength and airworthiness requirements.

Maximum Design Zero Fuel Weight (MZFW). Maximum weight allowed before usable fuel and other specified usable agents must be loaded in defined sections of the aircraft as limited by strength and airworthiness requirements.

Operating Empty Weight (OEW). Weight of structure, power plant, furnishing systems, unusable fuel and other unusable propulsion agents, and other items of equipment that are considered an integral part of a particular airplane configuration. Also included are certain standard items, personnel, equipment, and supplies necessary for full operations, excluding usable fuel and payload.

Maximum Payload. Maximum design zero fuel weight minus operational empty weight.

Maximum Seating Capacity. The maximum number of passengers specifically certificated or anticipated for certification.

Maximum Cargo Volume. The maximum space available for cargo.

Usable Fuel. Fuel available for aircraft propulsion.

2.1.1 General Characteristics: Model 737-7

CHARACTERISTICS	UNITS	MODEL 737-7	
MAX DESIGN TAXI WEIGHT	POUNDS	145,500	177,500
	KILOGRAMS	65,997	80,512
MAX DESIGN TAKEOFF WEIGHT	POUNDS	145,000	177,000
	KILOGRAMS	65,770	80,285
MAX DESIGN LANDING WEIGHT	POUNDS	140,900	145,600
	KILOGRAMS	63,911	66,043
MAX DESIGN ZERO FUEL WEIGHT	POUNDS	134,000	138,700
	KILOGRAMS	60,781	62,913
SEATING CAPACITY	TWO-CLASS	153	153
	SINGLE-CLASS	172	172
MAX CARGO VOLUME LOWER DECK	CUBIC FEET	1,139	1,139
	CUBIC METERS	32.3	32.3
USABLE FUEL *[1]	US GALLONS	6,820	6,820
	LITERS	25,816	25,816
	POUNDS	45,694	45,694
	KILOGRAMS	20,730	20,730

NOTES:

*[1] FUEL DENSITY = 6.7 LBS/US GAL

2.1.2 General Characteristics: Model 737-8

CHARACTERISTICS	UNITS	MODEL 737-8		
MAX DESIGN TAXI WEIGHT	POUNDS	159,900	180,300	182,700
	KILOGRAMS	72,529	81,782	82,871
MAX DESIGN TAKEOFF WEIGHT	POUNDS	159,400	179,800	182,200
	KILOGRAMS	72,302	81,555	82,644
MAX DESIGN LANDING WEIGHT	POUNDS	150,300	150,300	152,800
	KILOGRAMS	68,174	68,174	69,308
MAX DESIGN ZERO FUEL WEIGHT	POUNDS	142,900	142,900	145,400
	KILOGRAMS	64,818	64,818	65,952
SEATING CAPACITY	TWO-CLASS	178	178	178
	SINGLE-CLASS	189	189	189
MAX CARGO VOLUME LOWER DECK	CUBIC FEET	1,540	1,540	1,540
	CUBIC METERS	43.6	43.6	43.6
USABLE FUEL *[1]	US GALLONS	6,820	6,820	6,820
	LITERS	25,817	25,817	25,817
	POUNDS	45,694	45,694	45,694
	KILOGRAMS	20,730	20,730	20,730

NOTES:

*[1] FUEL DENSITY = 6.7 LBS/US GAL

2.1.3 General Characteristics: Model 737-8-200

CHARACTERISTICS	UNITS	MODEL 737-8-200		
MAX DESIGN TAXI WEIGHT	POUNDS	159,900	180,300	181,700
	KILOGRAMS	72,529	81,782	82,417
MAX DESIGN TAKEOFF WEIGHT	POUNDS	159,400	179,800	181,200
	KILOGRAMS	72,302	81,555	82,190
MAX DESIGN LANDING WEIGHT	POUNDS	150,300	150,300	152,800
	KILOGRAMS	68,174	68,174	69,308
MAX DESIGN ZERO FUEL WEIGHT	POUNDS	142,900	142,900	145,400
	KILOGRAMS	64,818	64,818	65,952
SEATING CAPACITY	TWO-CLASS	*[2]	*[2]	*[2]
	SINGLE-CLASS	200	201	202
MAX CARGO VOLUME LOWER DECK	CUBIC FEET	1,540	1,540	1,540
	CUBIC METERS	43.6	43.6	43.6
USABLE FUEL *[1]	US GALLONS	6,820	6,820	6,820
	LITERS	25,817	25,817	25,817
	POUNDS	45,694	45,694	45,694
	KILOGRAMS	20,730	20,730	20,730

NOTES:

*[1] FUEL DENSITY = 6.7 LBS/US GAL

*[2] ONLY SINGLE-CLASS LAYOUT

2.1.4 General Characteristics: Model BBJ MAX 8

CHARACTERISTICS	UNITS	MODEL BBJ MAX 8		
MAX DESIGN TAXI WEIGHT	POUNDS	159,900	180,300	181,700
	KILOGRAMS	72,529	81,782	82,417
MAX DESIGN TAKEOFF WEIGHT	POUNDS	159,400	179,800	181,200
	KILOGRAMS	72,302	81,555	82,190
MAX DESIGN LANDING WEIGHT	POUNDS	150,300	150,300	152,800
	KILOGRAMS	68,174	68,174	69,308
MAX DESIGN ZERO FUEL WEIGHT	POUNDS	142,900	142,900	145,400
	KILOGRAMS	64,818	64,818	65,952
SEATING CAPACITY	TWO-CLASS	*[1]	*[1]	*[1]
	SINGLE-CLASS	*[1]	*[1]	*[1]

AUXILIARY TANK CONFIGURATIONS: LOWER DECK MAXIMUM CARGO VOLUME AND USABLE FUEL*[2]											
	NUMBER OF AUXILIARY FUEL TANKS										
	0	0	0	0	0	1	1	2	1	2	2
FWD	0	0	0	0	0	1	1	2	1	2	2
AFT	0	1	2	3	4	3	4	3	5	4	5
TOTAL CARGO (CU FT)	1,526	1,272	1,272	1,176	1,066	968	858	855	746	745	633
TOTAL CARGO (CU M)	43.2	36.0	36.0	33.3	30.2	27.4	24.3	24.2	21.1	21.1	17.9
FUEL (US GAL)	6,820	7,335	7,791	8,310	8,834	8,802	9,326	9,325	9,871	9,849	10,394
FUEL (LITER)	25,816	27,765	29,492	31,456	33,440	33,319	35,302	35,298	37,365	37,282	39,345
FUEL (LBS)	45,694	49,145	52,200	55,677	59,188	58,973	62,484	62,478	66,136	65,988	69,640
FUEL (KGS)	20,730	22,295	23,682	25,259	26,852	26,755	28,347	28,344	30,004	29,937	31,594

NOTES:

*[1] BBJ LAYOUTS ARE CUSTOMIZED

*[2] FUEL DENSITY = 6.7 LBS/US GAL

2.1.5 General Characteristics: Model 737-9

CHARACTERISTICS	UNITS	MODEL 737-9		
MAX DESIGN TAXI WEIGHT	POUNDS	168,700	190,400	195,200
	KILOGRAMS	76,521	86,363	88,541
MAX DESIGN TAKEOFF WEIGHT	POUNDS	168,200	189,900	194,700
	KILOGRAMS	76,294	86,137	88,314
MAX DESIGN LANDING WEIGHT	POUNDS	155,700	155,700	163,900
	KILOGRAMS	70,624	70,624	74,343
MAX DESIGN ZERO FUEL WEIGHT	POUNDS	148,300	148,300	156,500
	KILOGRAMS	67,267	67,267	70,987
SEATING CAPACITY	TWO-CLASS	193	193	193
	SINGLE-CLASS	220	220	220
MAX CARGO VOLUME LOWER DECK	CUBIC FEET	1,811	1,811	1,811
	CUBIC METERS	51.3	51.3	51.3
USABLE FUEL *[1]	US GALLONS	6,820	6,820	6,820
	LITERS	25,817	25,817	25,817
	POUNDS	45,694	45,694	45,694
	KILOGRAMS	20,730	20,730	20,730

NOTES:

*[1] FUEL DENSITY = 6.7 LBS/US GAL

2.1.6 General Characteristics: Model BBJ MAX 9

CHARACTERISTICS	UNITS	MODEL BBJ MAX 9		
MAX DESIGN TAXI WEIGHT	POUNDS	168,700	190,400	195,200
	KILOGRAMS	76,521	86,363	88,541
MAX DESIGN TAKEOFF WEIGHT	POUNDS	168,200	189,900	194,700
	KILOGRAMS	76,294	86,137	88,314
MAX DESIGN LANDING WEIGHT	POUNDS	155,700	155,700	163,900
	KILOGRAMS	70,624	70,624	74,343
MAX DESIGN ZERO FUEL WEIGHT	POUNDS	148,300	148,300	156,500
	KILOGRAMS	67,267	67,267	70,987
SEATING CAPACITY	TWO-CLASS	*[1]	*[1]	*[1]
	SINGLE-CLASS	*[1]	*[1]	*[1]

AUXILIARY TANK CONFIGURATIONS: LOWER DECK MAXIMUM CARGO VOLUME AND USABLE FUEL*[2]													
	NUMBER OF AUXILIARY FUEL TANKS												
	0	0	0	0	0	1	1	2	1	2	2	3	3
FWD	0	0	0	0	0	1	1	2	1	2	2	3	3
AFT	0	1	2	3	4	3	4	3	5	4	5	4	5
TOTAL CARGO (CU FT)	1,797	1,543	1,543	1,447	1,337	1,239	1,129	1,126	1,016	1,016	903	903	790
TOTAL CARGO (CU M)	50.9	43.7	43.7	41.0	37.9	35.1	32.0	31.9	28.8	28.8	25.6	25.6	22.4
FUEL (US GAL)	6,820	7,335	7,791	8,310	8,834	8,802	9,326	9,325	9,871	9,849	10,394	10,376	10,921
FUEL (LITER)	25,817	27,766	29,492	31,457	33,440	33,319	35,303	35,299	37,366	37,283	39,346	39,277	41,340
FUEL (LBS)	45,694	49,145	52,200	55,677	59,188	58,973	62,484	62,478	66,136	65,988	69,640	69,519	73,171
FUEL (KGS)	20,726	22,292	23,677	25,255	26,847	26,750	28,342	28,339	29,999	29,932	31,588	31,533	33,190

NOTES:

*[1] BBJ LAYOUTS ARE CUSTOMIZED

*[2] FUEL DENSITY = 6.7 LBS/US GAL

2.1.7 General Characteristics: Model 737-10

CHARACTERISTICS	UNITS	MODEL 737-10		
MAX DESIGN TAXI WEIGHT	POUNDS	175,500	194,000	198,400
	KILOGRAMS	79,606	87,996	89,992
MAX DESIGN TAKEOFF WEIGHT	POUNDS	175,000	193,500	197,900
	KILOGRAMS	79,379	87,770	89,765
MAX DESIGN LANDING WEIGHT	POUNDS	161,300	161,300	167,400
	KILOGRAMS	73,165	73,165	75,931
MAX DESIGN ZERO FUEL WEIGHT	POUNDS	153,900	153,900	160,000
	KILOGRAMS	69,808	69,808	72,574
SEATING CAPACITY	TWO-CLASS	204	204	204
	SINGLE-CLASS	230	230	230
MAX CARGO VOLUME LOWER DECK	CUBIC FEET	1,961	1,961	1,961
	CUBIC METERS	55.5	55.5	55.5
USABLE FUEL *[1]	US GALLONS	6,820	6,820	6,820
	LITERS	25,817	25,817	25,817
	POUNDS	45,694	45,694	45,694
	KILOGRAMS	20,730	20,730	20,730

NOTES:

*[1] FUEL DENSITY = 6.7 LBS/US GAL

2.2 GENERAL DIMENSIONS

2.2.1 General Dimensions: Model 737-7

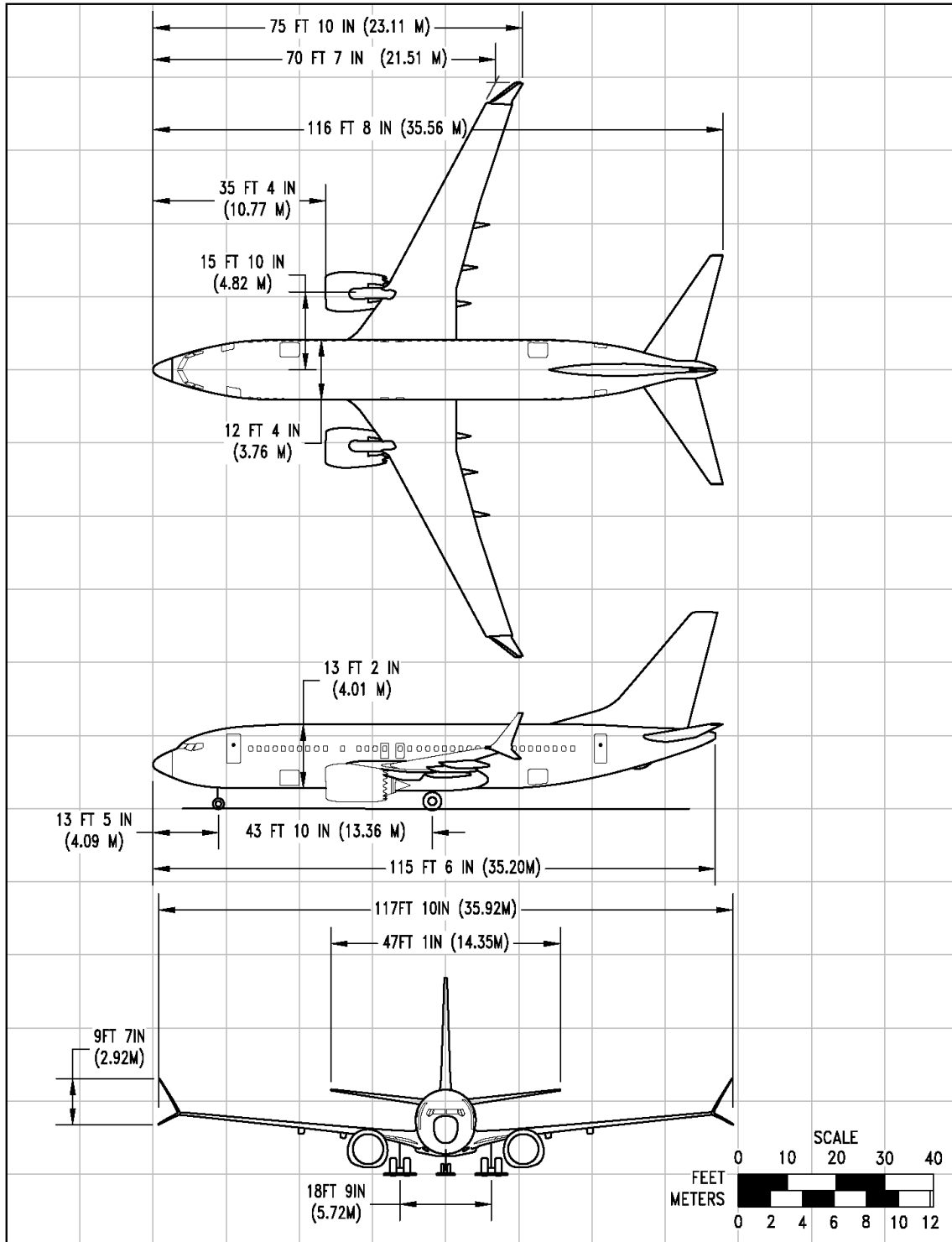

NOTE: THESE DRAWINGS ARE USED FOR AIRPORT PLANNING PURPOSES. THEY ARE ACCURATE WITHIN +/- 6 INCHES.

2.2.2 General Dimensions: Model 737-8 / -8-200 / BBJ MAX 8

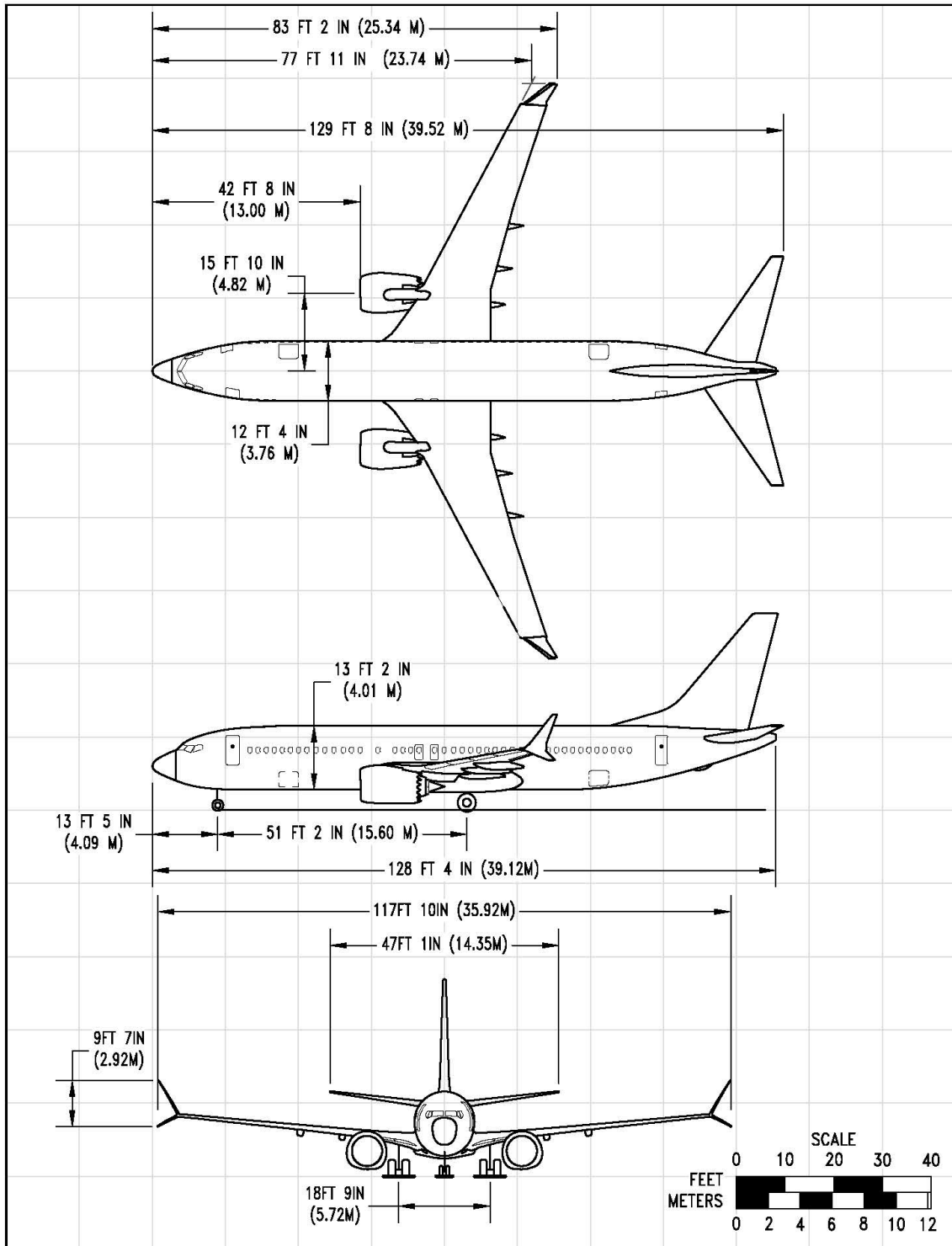

NOTE: THESE DRAWINGS ARE USED FOR AIRPORT PLANNING PURPOSES. THEY ARE ACCURATE WITHIN +/- 6 INCHES.

2.2.3 General Dimensions: Model 737-9 / BBJ MAX 9

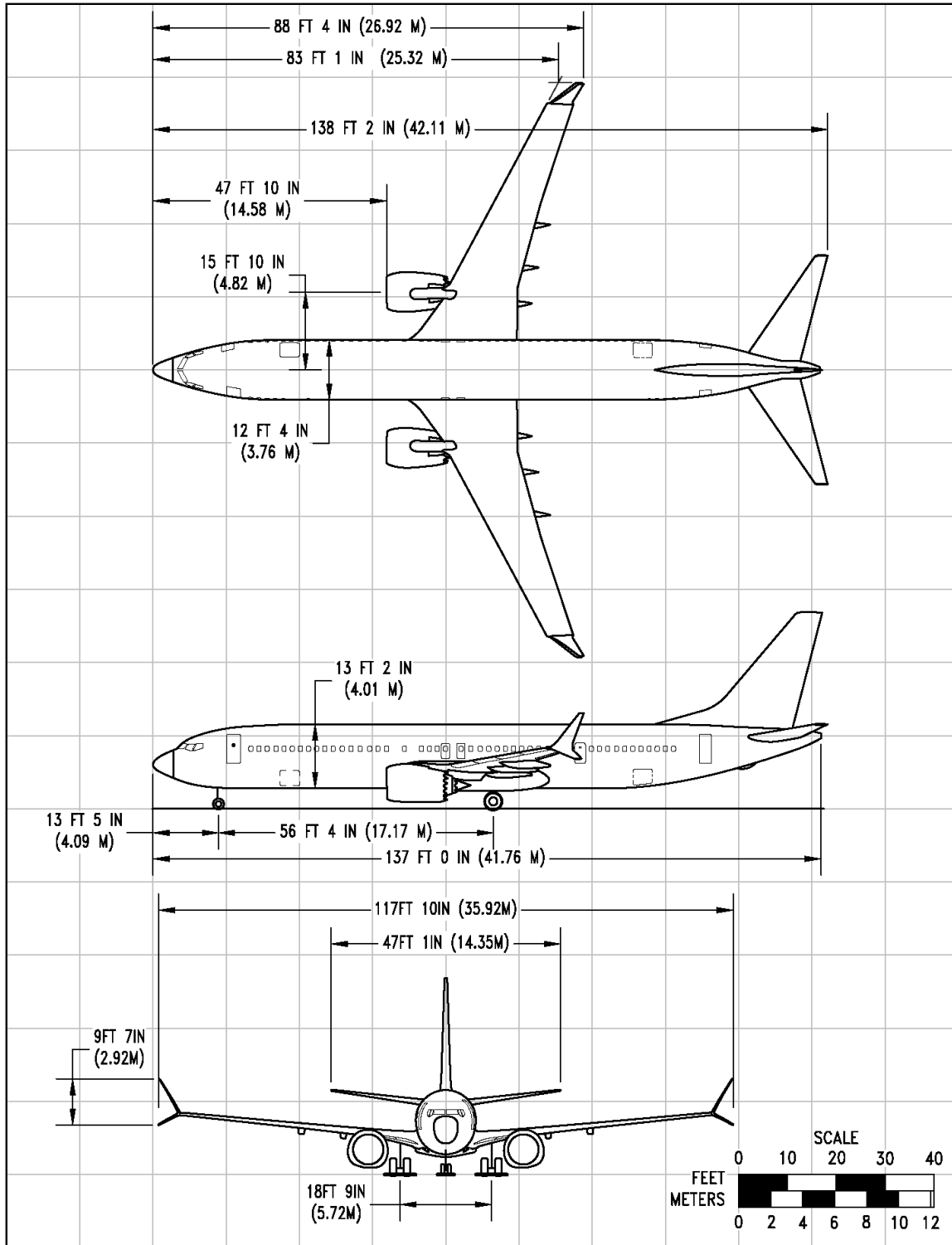

NOTE: THESE DRAWINGS ARE USED FOR AIRPORT PLANNING PURPOSES. THEY ARE ACCURATE WITHIN +/- 6 INCHES.

2.2.4 General Dimensions: Model 737-10

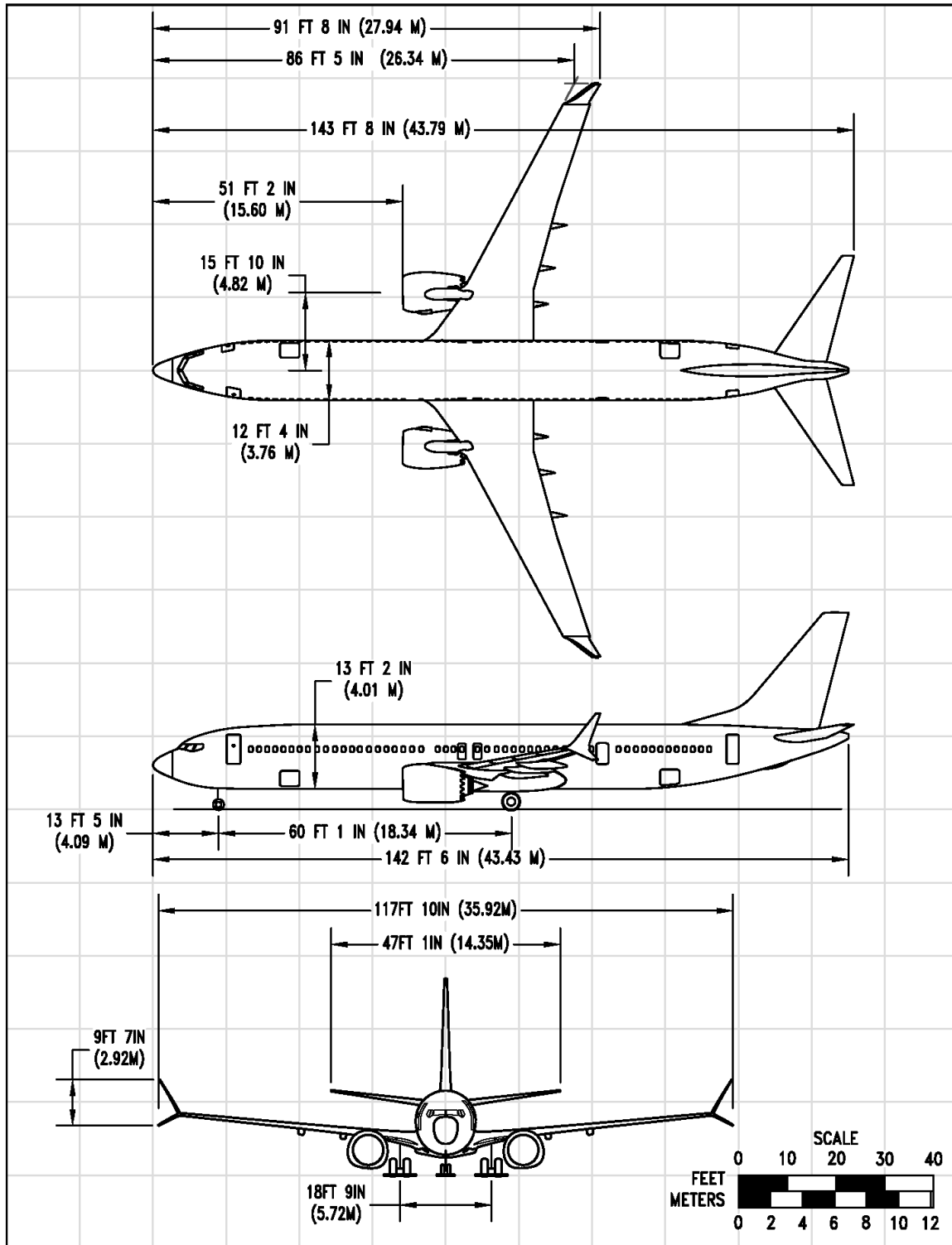

NOTE: THESE DRAWINGS ARE USED FOR AIRPORT PLANNING PURPOSES. THEY ARE ACCURATE WITHIN +/- 6 INCHES.

2.3 GROUND CLEARANCES

2.3.1 Ground Clearances: Model 737-7

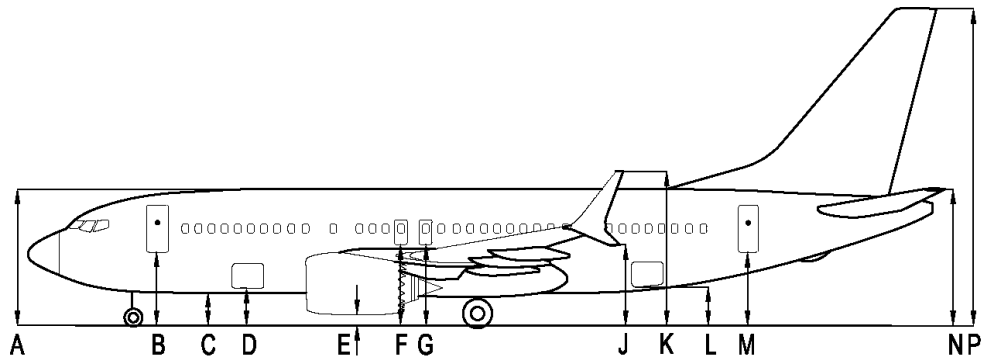

DESCRIPTION	737-7 *[1]			
	MINIMUM		MAXIMUM	
	FT - IN	M	FT - IN	M
A FUSELAGE - TOP	16-7	5.05	18-1	5.51
B FORWARD DOOR, LEFT & RIGHT	9-1	2.77	10-1	3.07
C FUSELAGE - BOTTOM	4-2	1.27	5-1	1.55
D FORWARD CARGO DOOR	4-8	1.42	5-6	1.68
E ENGINE	1-5	0.43	1-10	0.56
F FORWARD OVERWING EXIT DOOR, LEFT & RIGHT	10-2	3.10	10-7	3.23
G AFT OVERWING EXIT, LEFT & RIGHT	10-2	3.10	10-6	3.20
J WINGLET BLADE, LOWER	9-2	2.79	10-4	3.15
K WINGLET BLADE, UPPER	18-9	5.72	19-11	6.07
L AFT CARGO DOOR	4-4	1.32	5-5	1.65
M AFT PASSENGER DOOR, LEFT & RIGHT	8-2	2.49	9-7	2.92
N HORIZONTAL STABILIZER	15-8	4.78	17-8	5.38
P VERTICAL STABILIZER	38-10	11.84	41-0	12.50

NOTES:

*[1] CLEARANCES SHOWN ARE NOMINAL. ADD PLUS OR MINUS 3 INCHES TO ACCOUNT FOR VARIATIONS IN LOADING, OLEO AND TIRE PRESSURES, CENTER OF GRAVITY, ETC. DURING ROUTINE SERVICING, THE AIRPLANE REMAINS RELATIVELY STABLE, PITCH AND ELEVATION CHANGES OCCURRING SLOWLY.

2.3.2 Ground Clearances: Model 737-8 / -8-200 / BBJ MAX 8

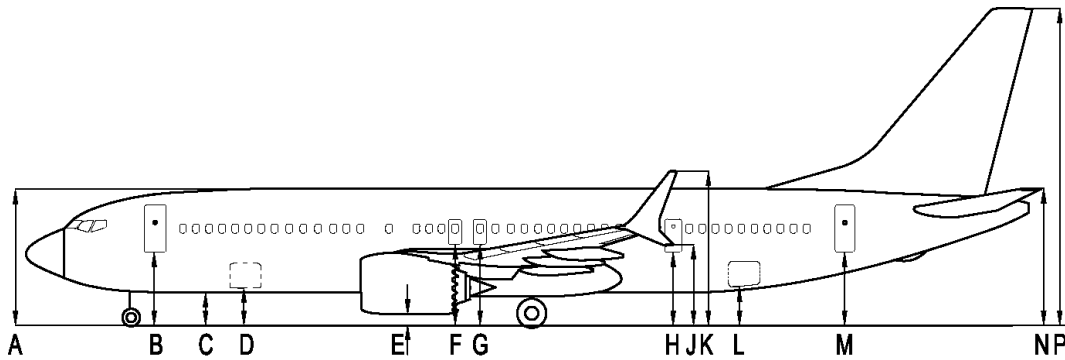

DESCRIPTION	737-8 / -8-200 / BBJ MAX 8 *[1]			
	MINIMUM		MAXIMUM	
	FT - IN	M	FT - IN	M
A FUSELAGE - TOP	16-8	5.08	18-1	5.51
B FORWARD DOOR, LEFT & RIGHT	9-1	2.77	10-1	3.07
C FUSELAGE - BOTTOM	4-2	1.27	5-1	1.55
D FORWARD CARGO DOOR	4-8	1.42	5-6	1.68
E ENGINE	1-5	0.43	1-10	0.56
F FORWARD OVERWING EXIT DOOR, LEFT & RIGHT	10-2	3.10	10-7	3.23
G AFT OVERWING EXIT, LEFT & RIGHT	10-2	3.10	10-6	3.20
H MID EXIT DOOR, LEFT & RIGHT *[2]	8-8	2.64	9-5	2.87
J WINGLET BLADE, LOWER	9-2	2.79	10-4	3.15
K WINGLET BLADE, UPPER	18-9	5.72	19-11	6.07
L AFT CARGO DOOR	4-4	1.32	5-5	1.65
M AFT PASSENGER DOOR, LEFT & RIGHT	8-2	2.49	9-6	2.90
N HORIZONTAL STABILIZER	15-8	4.78	17-7	5.36
P VERTICAL STABILIZER	38-11	11.86	40-10	12.45

NOTES:

*[1] CLEARANCES SHOWN ARE NOMINAL. ADD PLUS OR MINUS 3 INCHES TO ACCOUNT FOR VARIATIONS IN LOADING, OLEO AND TIRE PRESSURES, CENTER OF GRAVITY, ETC. DURING ROUTINE SERVICING, THE AIRPLANE REMAINS RELATIVELY STABLE, PITCH AND ELEVATION CHANGES OCCURRING SLOWLY.

*[2] MID EXIT DOOR ONLY EQUIPPED ON 737-8-200.

2.3.3 Ground Clearances: Model 737-9 / BBJ MAX 9

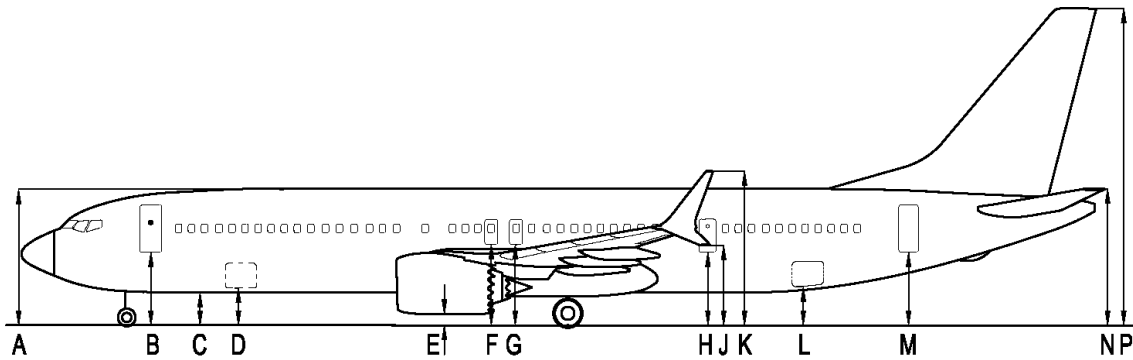

DESCRIPTION	737-9 / BBJ MAX 9 *[1]			
	MINIMUM		MAXIMUM	
	FT - IN	M	FT - IN	M
A FUSELAGE - TOP	16-8	5.08	18-1	5.51
B FORWARD DOOR, LEFT & RIGHT	9-2	2.79	10-1	3.07
C FUSELAGE - BOTTOM	4-2	1.27	5-1	1.55
D FORWARD CARGO DOOR	4-9	1.45	5-6	1.68
E ENGINE	1-5	0.43	1-10	0.56
F FORWARD OVERWING EXIT DOOR, LEFT & RIGHT	10-2	3.10	10-5	3.18
G AFT OVERWING EXIT, LEFT & RIGHT	10-2	3.10	10-5	3.18
H MID EXIT DOOR, LEFT & RIGHT	8-9	2.67	9-5	2.87
J WINGLET BLADE, LOWER	9-2	2.79	10-4	3.15
K WINGLET BLADE, UPPER	18-9	5.72	19-11	6.07
L AFT CARGO DOOR	4-4	1.32	5-4	1.63
M AFT PASSENGER DOOR, LEFT & RIGHT	8-3	2.51	9-3	2.82
N HORIZONTAL STABILIZER	15-9	4.80	17-6	5.33
P VERTICAL STABILIZER	39-0	11.89	40-8	12.40

NOTE:

*[1] CLEARANCES SHOWN ARE NOMINAL. ADD PLUS OR MINUS 3 INCHES TO ACCOUNT FOR VARIATIONS IN LOADING, OLEO AND TIRE PRESSURES, CENTER OF GRAVITY, ETC. DURING ROUTINE SERVICING, THE AIRPLANE REMAINS RELATIVELY STABLE, PITCH AND ELEVATION CHANGES OCCURRING SLOWLY.

2.3.4 Ground Clearances: Model 737-10

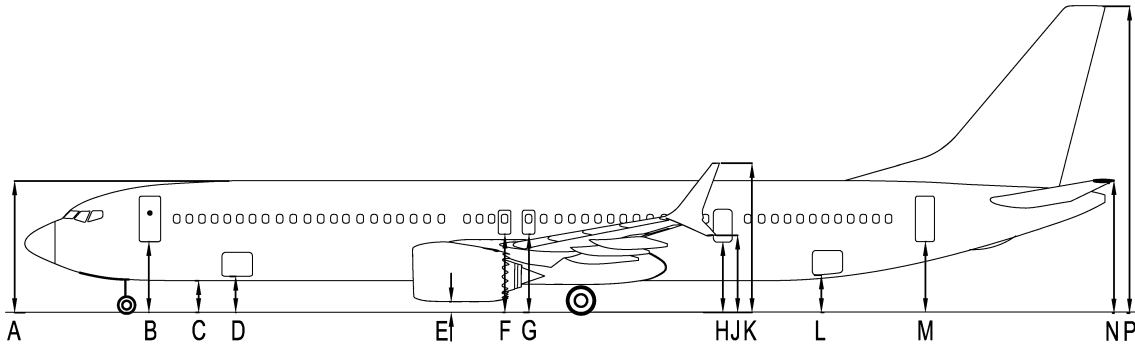

DESCRIPTION	737-10 *[1]			
	MINIMUM		MAXIMUM	
	FT - IN	M	FT - IN	M
A FUSELAGE - TOP	16-8	5.08	18-2	5.54
B FORWARD DOOR, LEFT & RIGHT	9-1	2.77	10-1	3.07
C FUSELAGE - BOTTOM	4-2	1.27	5-1	1.55
D FORWARD CARGO DOOR	4-8	1.42	5-6	1.68
E ENGINE	1-5	0.43	1-10	0.56
F FORWARD OVERWING EXIT DOOR, LEFT & RIGHT	10-2	3.10	10-6	3.20
G AFT OVERWING EXIT, LEFT & RIGHT	10-2	3.10	10-6	3.20
H MID EXIT DOOR, LEFT & RIGHT	8-9	2.67	9-5	2.87
J WINGLET BLADE, LOWER	9-2	2.79	10-4	3.15
K WINGLET BLADE, UPPER	18-9	5.72	19-11	6.07
L AFT CARGO DOOR	4-5	1.35	5-5	1.65
M AFT PASSENGER DOOR, LEFT & RIGHT	8-4	2.54	9-5	2.87
N HORIZONTAL STABILIZER	15-10	4.83	17-8	5.38
P VERTICAL STABILIZER	39-1	11.91	40-10	12.45

NOTE:

*[1] CLEARANCES SHOWN ARE NOMINAL. ADD PLUS OR MINUS 3 INCHES TO ACCOUNT FOR VARIATIONS IN LOADING, OLEO AND TIRE PRESSURES, CENTER OF GRAVITY, ETC. DURING ROUTINE SERVICING, THE AIRPLANE REMAINS RELATIVELY STABLE, PITCH AND ELEVATION CHANGES OCCURRING SLOWLY.

2.4 INTERIOR ARRANGEMENTS

2.4.1 Interior Arrangements: Model 737-7

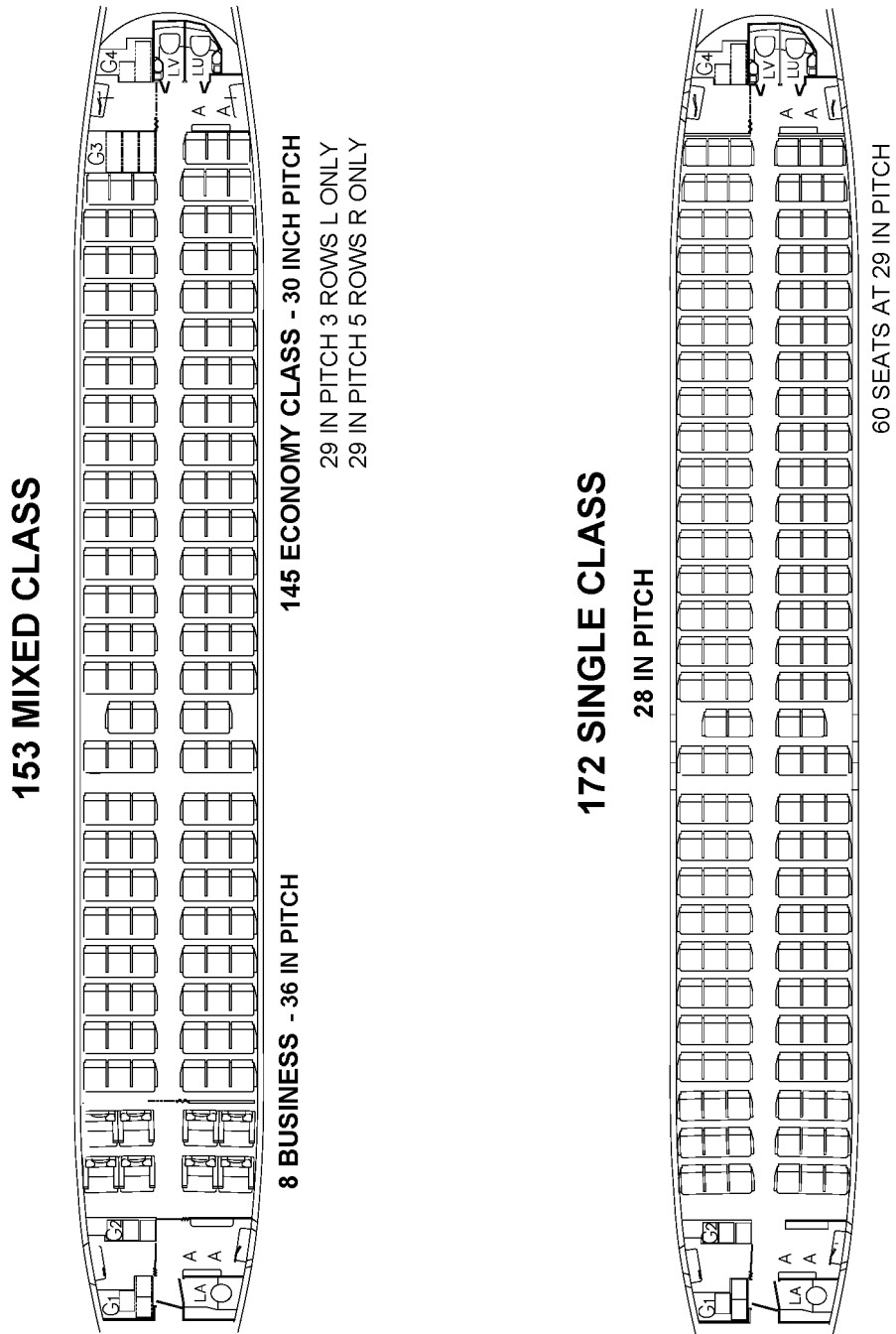

2.4.2 Interior Arrangements: Model 737-8

178 MIXED CLASS

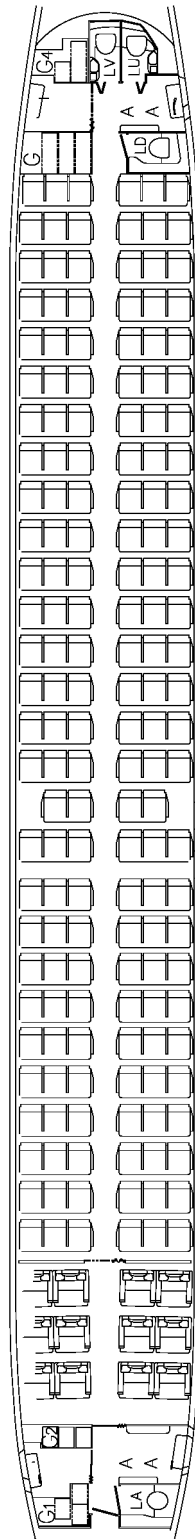

12 BUSINESS - 36 IN PITCH

166 ECONOMY - 30 IN PITCH
24 SEATS AT 29 IN PITCH

189 SINGLE CLASS
30 IN PITCH

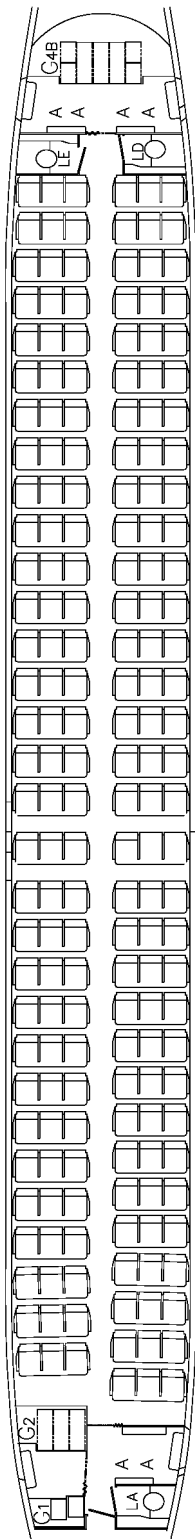

29 IN PITCH 9 ROWS L ONLY

29 IN PITCH 5 ROWS

2.4.3 Interior Arrangements: Model 737-8-200

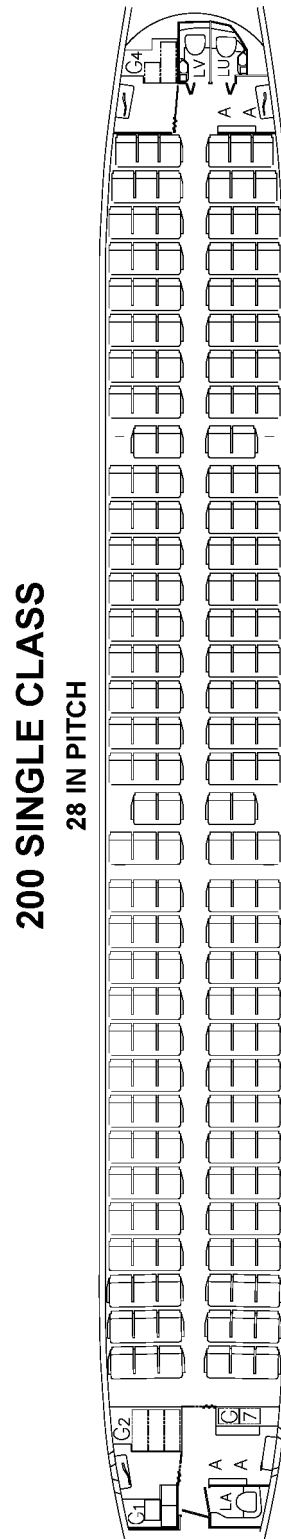

2.4.4 Interior Arrangements: Model 737-9

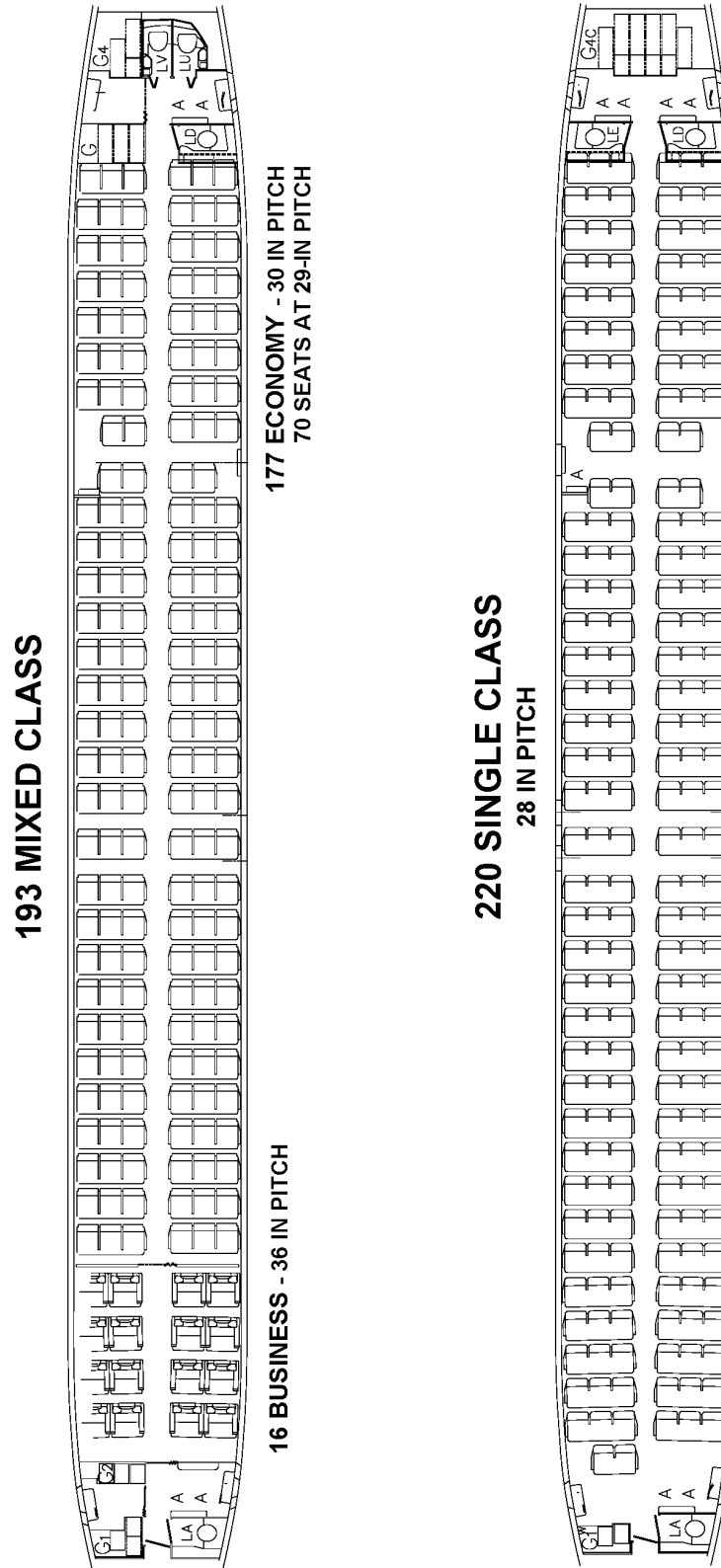

2.4.5 Interior Arrangements: Model 737-10

204 MIXED CLASS

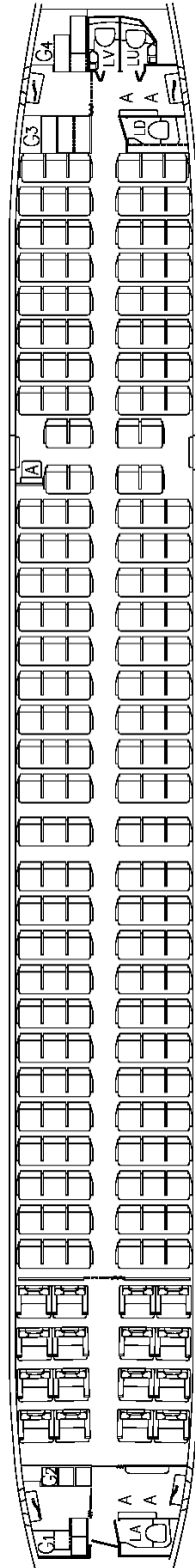

16 BUSINESS - 36-IN PITCH

188 ECONOMY - 30-IN PITCH
46 SEATS AT 29-IN PITCH

230 SINGLE CLASS

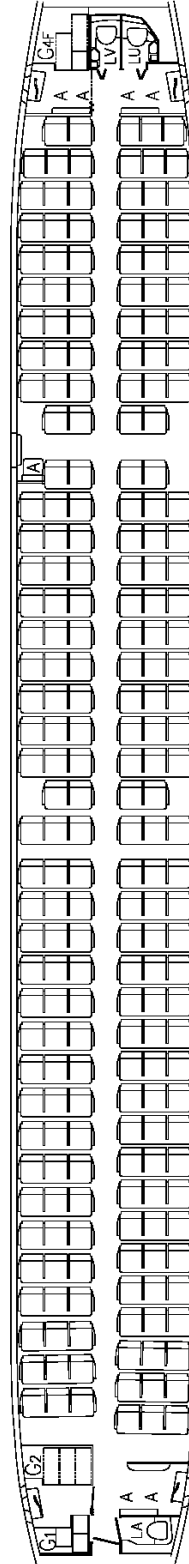

230 TOURIST - 28-IN PITCH
39 SEATS AT 29-IN PITCH

2.5 CABIN CROSS SECTIONS

2.5.1 Cabin Cross-Sections: All Models

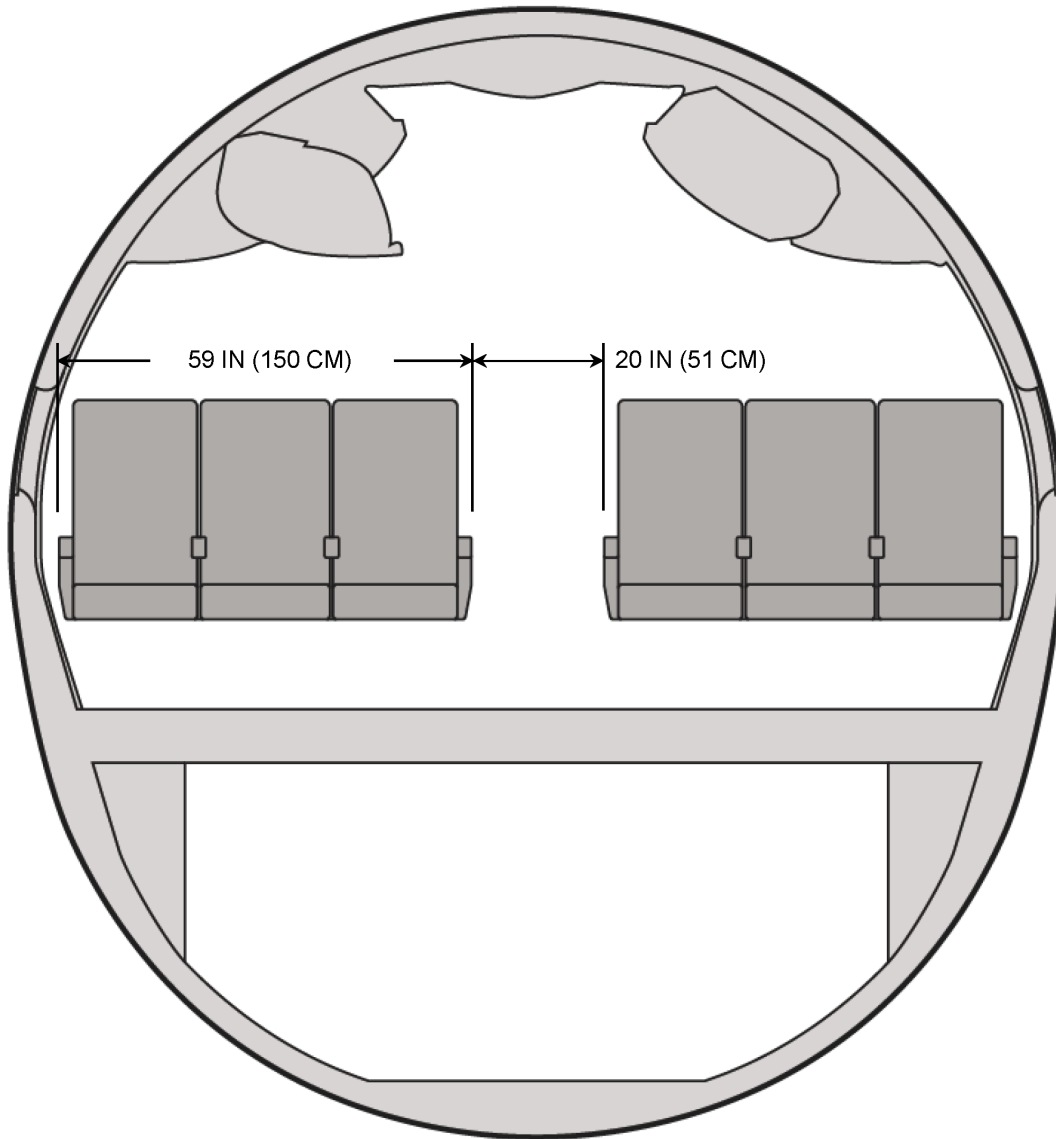

2.6 LOWER CARGO COMPARTMENTS

2.6.1 Lower Cargo Compartments: All Models

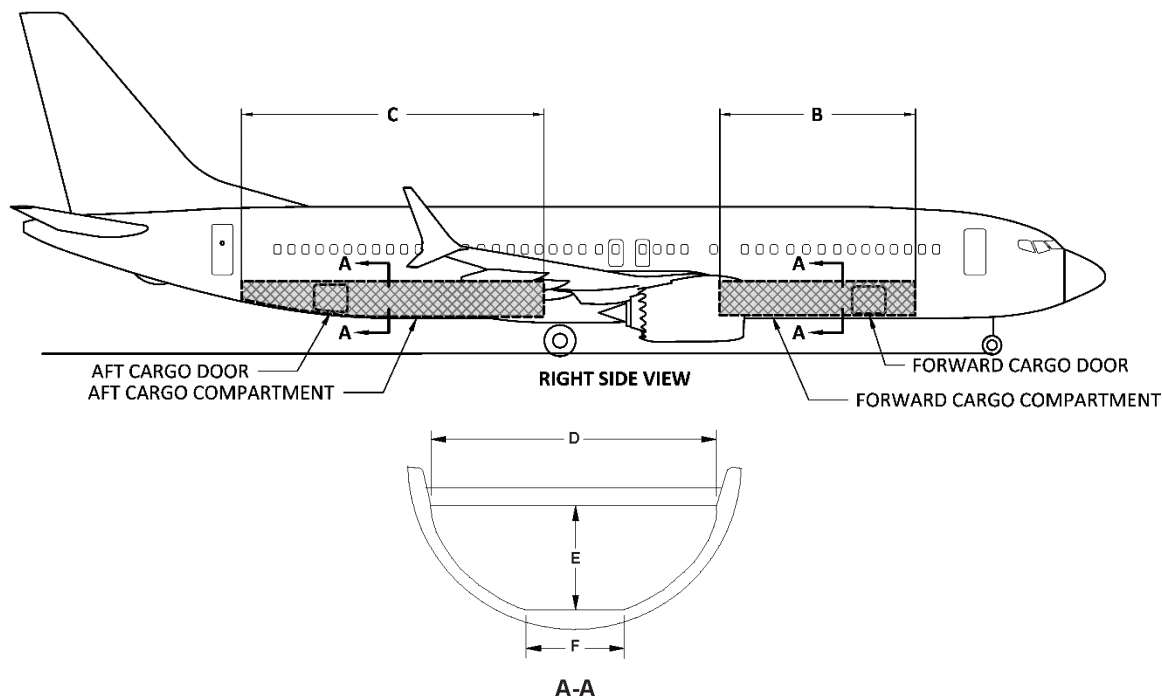

LOWER LOBE CARGO/BAGGAGE COMPARTMENT SIZES *[1]		
AIRPLANE MODEL	FORWARD COMPARTMENT (B)	AFT COMPARTMENT (C) *[2]
737-7	17 FT - 4 IN (5.28 M)	30 FT - 3 IN (9.22 M)
737-8/-8-200/ BBJ MAX 8	24 FT - 8 IN (7.52 M)	35 FT - 9 IN (10.90 M)
737-9 / BBJ MAX 9	29 FT - 10 IN (9.09 M)	39 FT - 3 IN (11.96 M)
737-10	32 FT - 4 IN (9.86 M)	41 FT - 4 IN (12.60 M)

SECT A-A	FORWARD CARGO COMPARTMENT	AFT CARGO COMPARTMENT FORWARD BULKHEAD	AFT CARGO COMPARTMENT AFT BULKHEAD
D	10 FT - 0 IN (3.05 M)	9 FT - 7 IN (2.92 M)	6 FT - 10 IN (2.08 M)
E	3 FT - 8 IN (1.12 M)	3 FT - 11 IN (1.19 M)	1 FT - 11 IN (0.59 M)
F	4 FT - 0 IN (1.22 M)	4 FT - 0 IN (1.22 M)	4 FT - 0 IN (1.22 M)

MAXIMUM LOWER LOBE CARGO/BAGGAGE COMPARTMENT VOLUMES *[1]			
AIRPLANE MODEL	FORWARD COMPARTMENT BULK CARGO	AFT COMPARTMENT BULK CARGO *[2]	TOTAL BULK CARGO
737-7	432 CU FT (12.2 CU M)	714 CU FT (20.2 CU M)	1,146 CU FT (32.4 CU M)
737-8/-8-200/ BBJ MAX 8	662 CU FT (18.7 CU M)	883 CU FT (25.0 CU M)	1,545 CU FT (43.7 CU M)
737-9 / BBJ MAX 9	820 CU FT (23.2 CU M)	996 CU FT (28.2 CU M)	1,816 CU FT (51.4 CU M)
737-10	911 CU FT (25.8 CU M)	1,050 CU FT (29.7 CU M)	1,961 CU FT (55.5 CU M)

NOTES:

*[1] DOES NOT ACCOUNT FOR BBJ MAX CONFIGURATIONS WITH AUXILIARY TANKS

*[2] OPTIONAL EXTENDED E6 RACK REDUCES CARGO VOLUME BY 14 CU FT (STANDARD ON BBJ MAX)

2.6.2 Lower Cargo Compartments: Model BBJ MAX 8

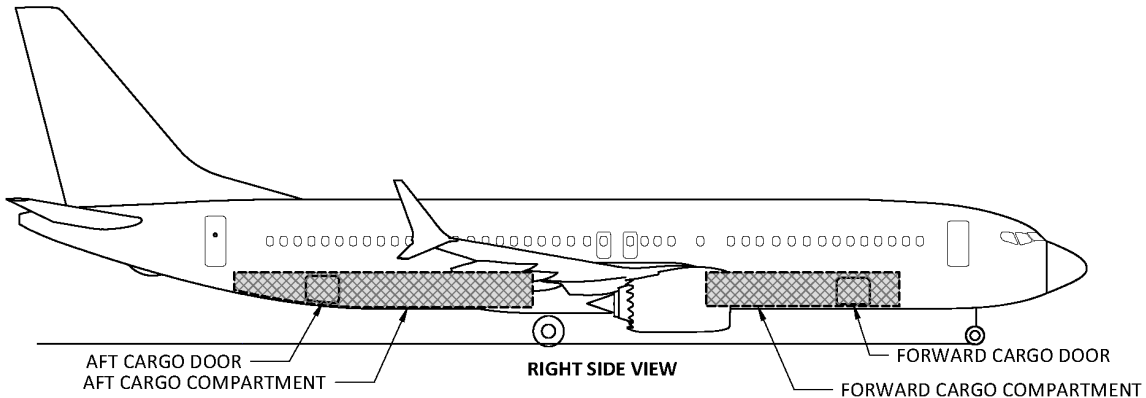

MAXIMUM LOWER LOBE CARGO/BAGGAGE COMPARTMENT VOLUMES				
FORWARD AUXILIARY TANKS	FORWARD COMPARTMENT BULK CARGO	AFT AUXILIARY TANKS	AFT COMPARTMENT BULK CARGO	TOTAL BULK CARGO
0	657 CU FT (18.6 CU M)	0	869 CU FT (24.6 CU M)	1,526 CU FT (43.2 CU M)
0	657 CU FT (18.6 CU M)	1	615 CU FT (17.4 CU M)	1,272 CU FT (36.0 CU M)
0	657 CU FT (18.6 CU M)	2	615 CU FT (17.4 CU M)	1,272 CU FT (36.0 CU M)
0	657 CU FT (18.6 CU M)	3	519 CU FT (14.7 CU M)	1,176 CU FT (33.3 CU M)
0	657 CU FT (18.6 CU M)	4	409 CU FT (11.6 CU M)	1,066 CU FT (30.2 CU M)
1	449 CU FT (12.7 CU M)	3	519 CU FT (14.7 CU M)	968 CU FT (27.4CU M)
1	449 CU FT (12.7 CU M)	4	409 CU FT (11.6 CU M)	858 CU FT (24.3 CU M)
2	336 CU FT (9.5 CU M)	3	519 CU FT (14.7 CU M)	855 CU FT (24.2 CU M)
1	449 CU FT (12.7 CU M)	5	297 CU FT (8.4 CU M)	746 CU FT (21.1 CU M)
2	336 CU FT (9.5 CU M)	4	409 CU FT (11.6 CU M)	745 CU FT (21.1 CU M)
2	336 CU FT (9.5 CU M)	5	297 CU FT (8.4 CU M)	633 CU FT (17.9 CU M)

2.6.3 Lower Cargo Compartments: Model BBJ MAX 9

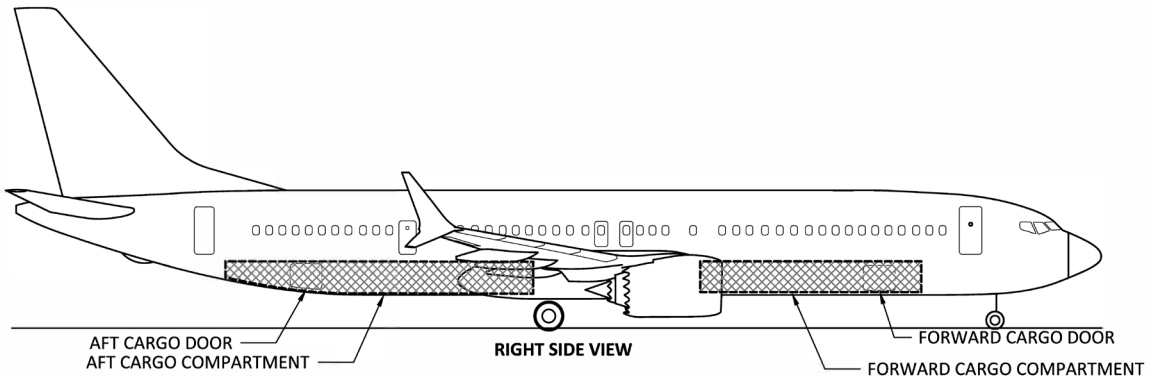

MAXIMUM LOWER LOBE CARGO/BAGGAGE COMPARTMENT VOLUMES				
FORWARD AUXILIARY TANKS	FORWARD COMPARTMENT BULK CARGO	AFT AUXILIARY TANKS	AFT COMPARTMENT BULK CARGO	TOTAL BULK CARGO
0	815 CU FT (23.1 CU M)	0	982 CU FT (27.8 CU M)	1,797 CU FT (50.9 CU M)
0	815 CU FT (23.1 CU M)	1	728 CU FT (20.6 CU M)	1,543 CU FT (43.7 CU M)
0	815 CU FT (23.1 CU M)	2	728 CU FT (20.6 CU M)	1,543 CU FT (43.7 CU M)
0	815 CU FT (23.1 CU M)	3	632 CU FT (17.9 CU M)	1,447 CU FT (41.0 CU M)
0	815 CU FT (23.1 CU M)	4	522 CU FT (14.8 CU M)	1,337 CU FT (37.9 CU M)
1	607 CU FT (17.2 CU M)	3	632 CU FT (17.9 CU M)	1,239 CU FT (35.1 CU M)
1	607 CU FT (17.2 CU M)	4	522 CU FT (14.8 CU M)	1,129 CU FT (32.0 CU M)
2	494 CU FT (14.0 CU M)	3	632 CU FT (17.9 CU M)	1,126 CU FT (31.9 CU M)
1	607 CU FT (17.2 CU M)	5	409 CU FT (11.6 CU M)	1,016 CU FT (28.8 CU M)
2	494 CU FT (14.0 CU M)	4	522 CU FT (14.8 CU M)	1,016 CU FT (28.8 CU M)
2	494 CU FT (14.0 CU M)	5	409 CU FT (11.6 CU M)	903 CU FT (25.6 CU M)
3	381 CU FT (10.8 CU M)	4	522 CU FT (14.8 CU M)	903 CU FT (25.6 CU M)
3	381 CU FT (10.8 CU M)	5	409 CU FT (11.6 CU M)	790 CU FT (22.4 CU M)

2.7 DOOR CLEARANCES

2.7.1 Passenger and Cargo Door Locations: All Models

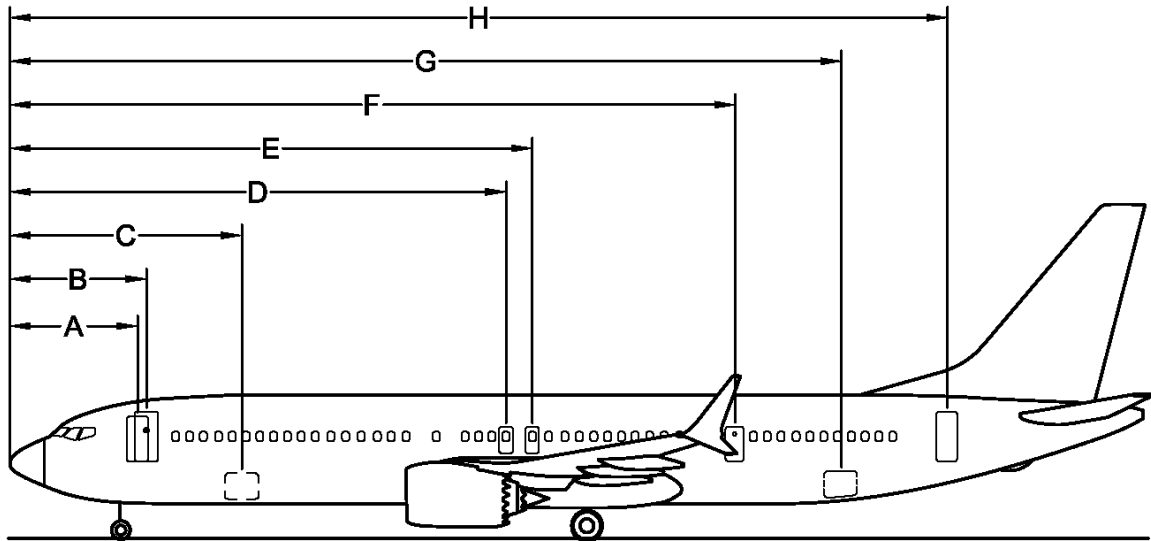

SEE NOTE *[3]

	DOOR NAME	DOOR LOCATION	737-7 FT-IN (M)	737-8/ BBJ MAX 8 FT-IN (M)	737-8-200 FT-IN (M)	737-9/ BBJ MAX 9 FT-IN (M)	737-10 FT-IN (M)
A	FWD SERVICE DOOR NO. 1	RIGHT	15-4 (4.67)	15-4 (4.67)	15-4 (4.67)	15-4 (4.67)	15-4 (4.67)
B	FWD MAIN ENTRY DOOR NO. 1	LEFT	16-6 (5.03)	16-6 (5.03)	16-6 (5.03)	16-6 (5.03)	16-6 (5.03)
C	FORWARD CARGO DOOR	RIGHT	28-0 (8.53)	28-0 (8.53)	28-0 (8.53)	28-0 (8.53)	28-0 (8.53)
D	EMERGENCY EXIT DOOR	LEFT AND RIGHT	47-6 (14.48)	54-10 (16.71)	54-10 (16.71)	60-0 (18.29)	63-4 (19.30)
E	EMERGENCY EXIT DOOR	LEFT AND RIGHT	50-8 (15.44)	58-0 (17.68)	58-0 (17.68)	63-2 (19.25)	66-6 (20.27)
F	MID EXIT DOOR *[1]	LEFT AND RIGHT	N/A	N/A	82-8 (25.20)	87-7 (26.70)	92-1 (28.06)
G	AFT CARGO DOOR	RIGHT	78-11 (24.05)	91-9 (27.97)	91-9 (27.97)	100-5 (30.61)	105-11 (32.28)
H	AFT ENTRY/ SERVICE DOOR NO. 2 *[2]	LEFT AND RIGHT	91-9 (27.97)	104-7 (31.88)	104-7 (31.88)	113-3 (34.52)	118-9 (36.20)

NOTES:

- *[1] MID EXIT DOOR NOT ON 737-7 / -8 / BBJ MAX 8
- *[2] ENTRY DOORS LEFTSIDE, SERVICE DOORS RIGHTSIDE
- *[3] SEE SECTION 2.3 FOR DOOR SILL HEIGHTS

2.7.2 Door Clearances - Forward Main Entry Door: All Models

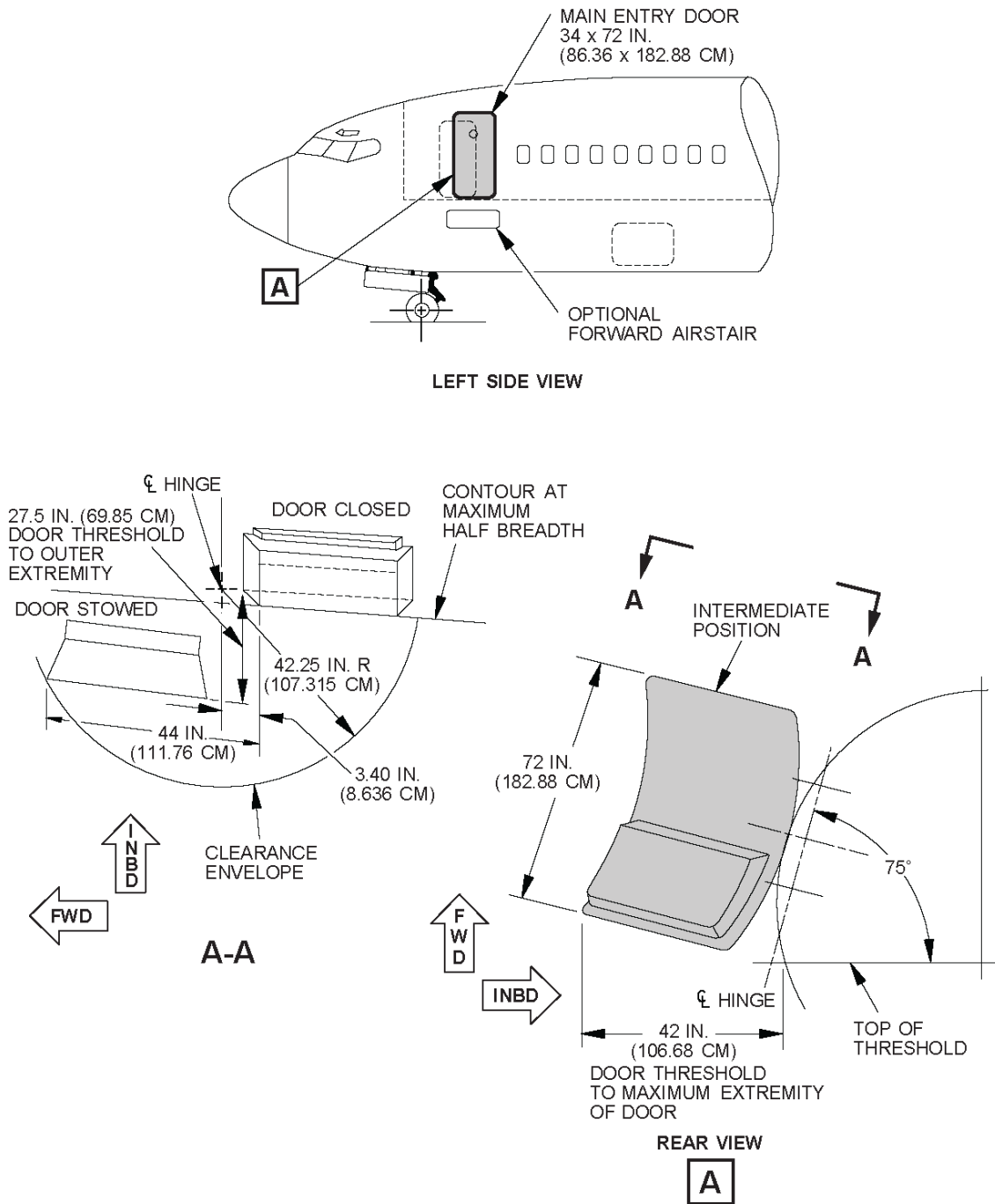

NOTE: SEE SEC 2.7.1 FOR DOOR LOCATION

2.7.3 Door Clearances - Optional Forward Airstairs, Forward Main Entry Door: All Models

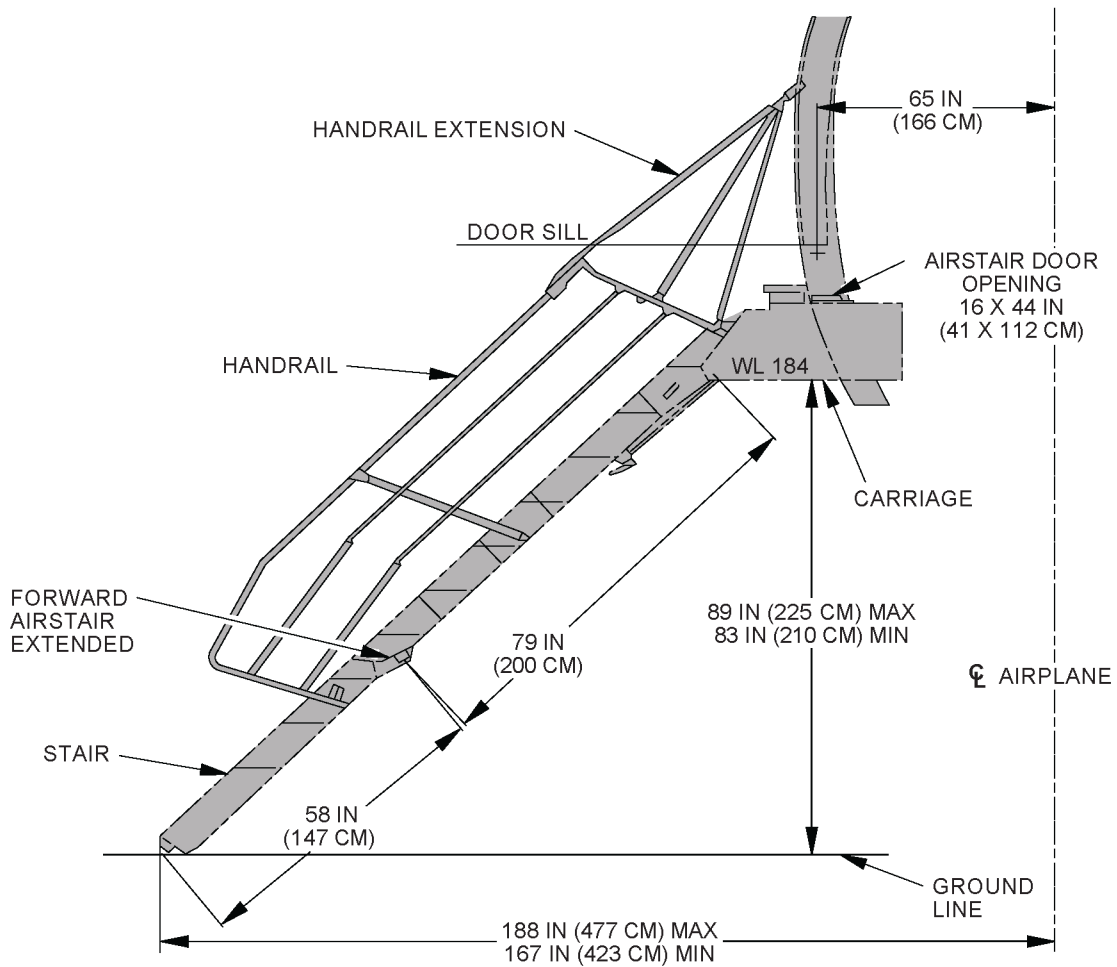

2.7.4 Door Clearances: Sensor and Probe Locations - Forward Cabin Doors: All Models

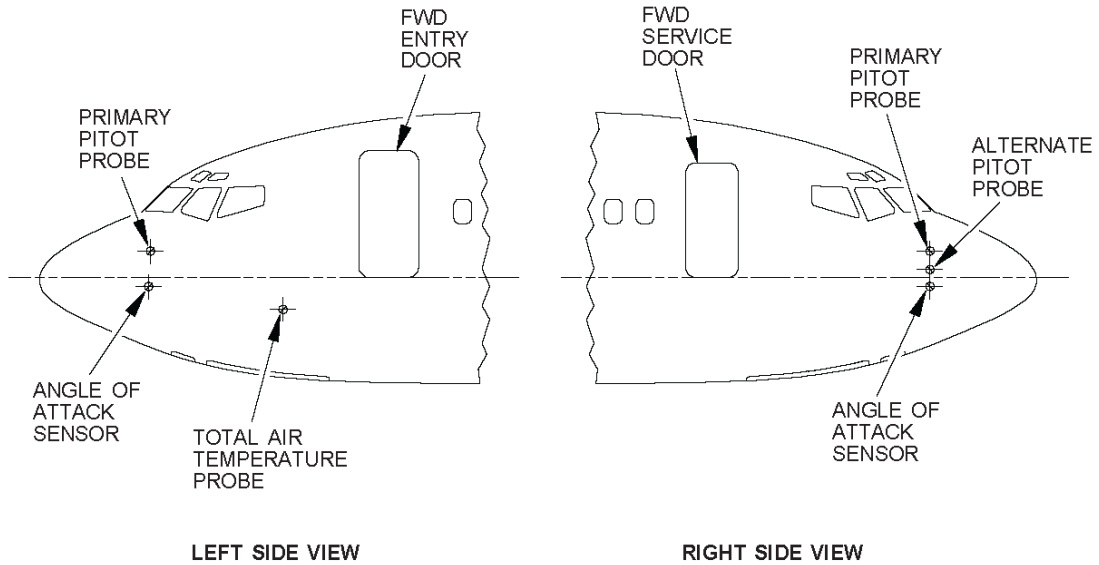

PROBE/SENSOR (SIDE)	DISTANCE AFT OF NOSE	DISTANCE ABOVE (+) OR BELOW (-) DOOR SILL REFERENCE LINE
PRIMARY PITOT (LEFT/RIGHT)	5 FT 2 IN (1.57 M)	+ 15 IN (0.38 M)
ALTERNATE PITOT (RIGHT)	5 FT 2 IN (1.57 M)	+ 3 IN (0.08 M)
ANGLE OF ATTACK (LEFT/RIGHT)	5 FT 2 IN (1.57 M)	- 6 IN (0.15 M)
TOTAL AIR TEMPERATURE (LEFT)	11 FT 6 IN (3.51 M)	- 18 IN (0.46 M)

2.7.5 Door Clearances – Forward Service Door: All Models

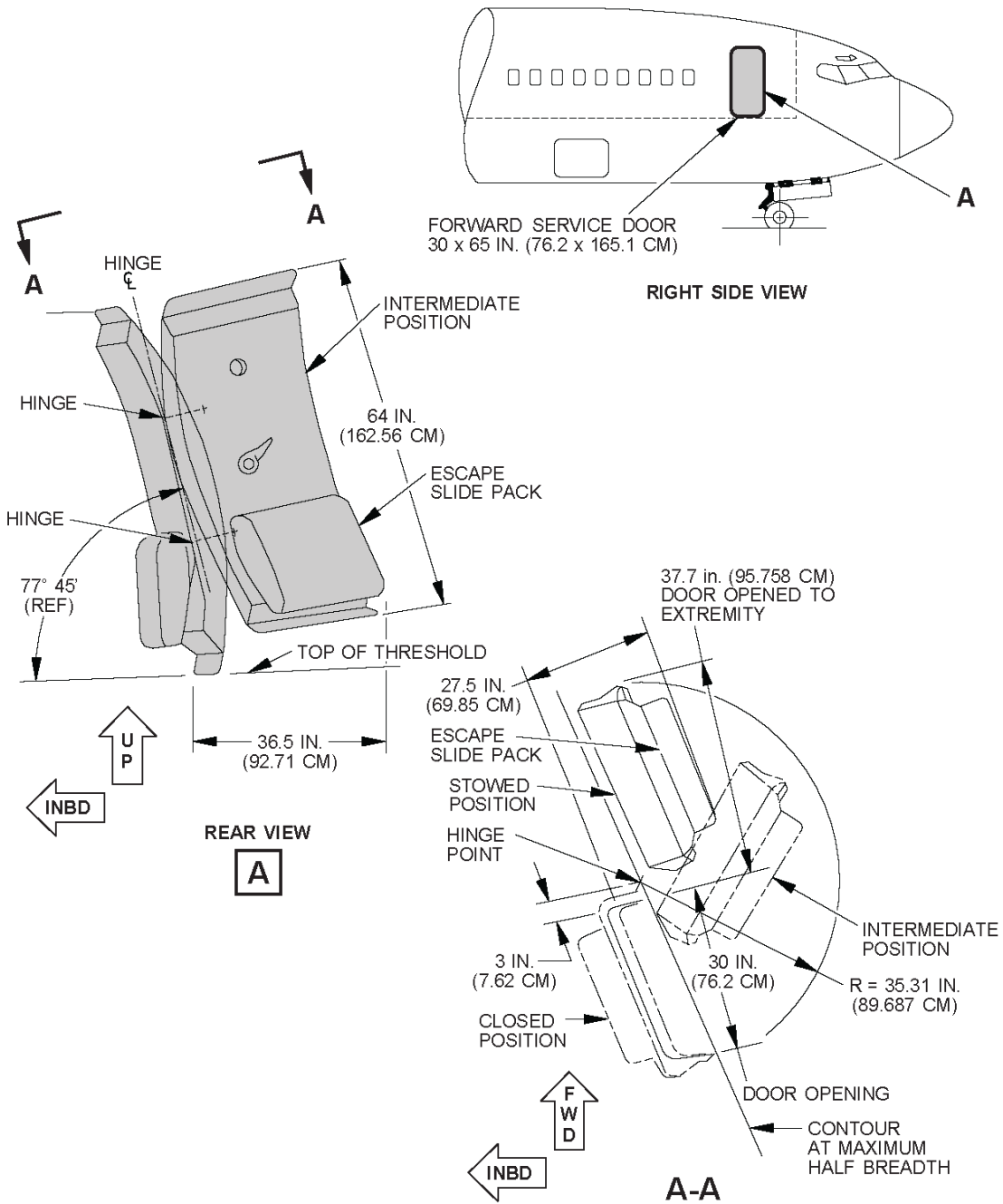

NOTE: SEE SEC 2.7.1 FOR DOOR LOCATION

2.7.6 Door Clearances - Aft Entry/Service Door: All Models

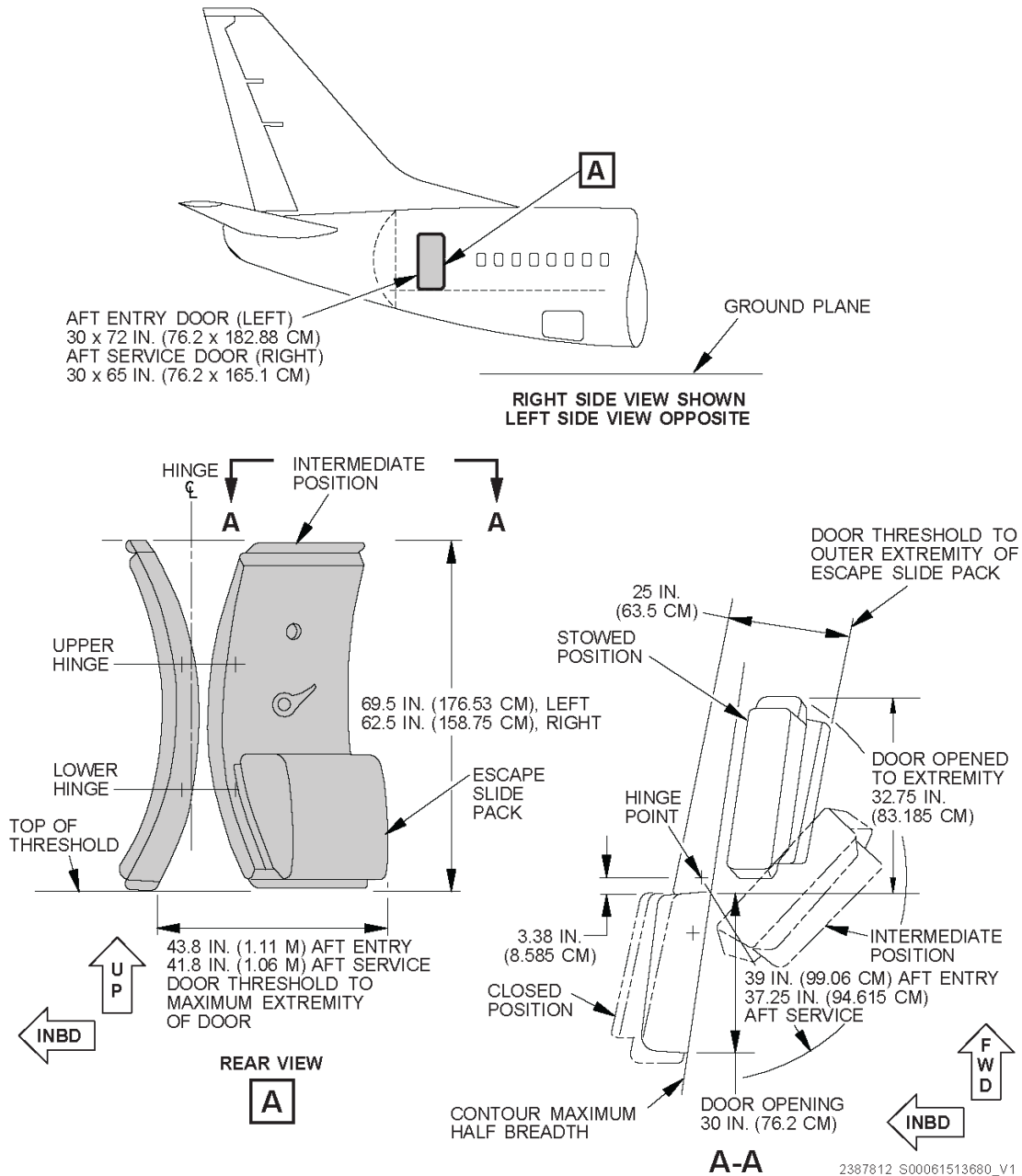

NOTE: SEE SEC 2.7.1 FOR DOOR LOCATION

2.7.7 Door Clearances - Lower Deck Cargo Compartments: All Models

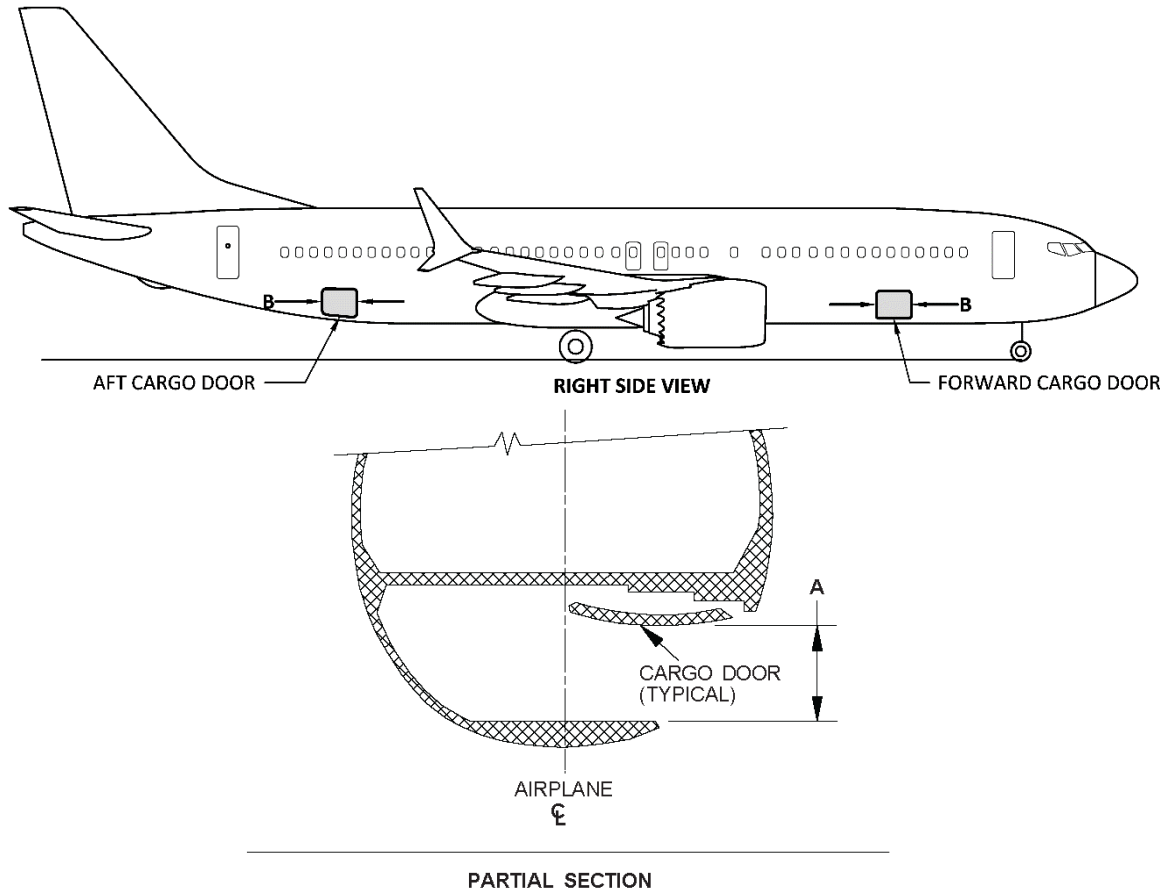

	DOOR SIZE	CLEAR OPENING (A x B)
FORWARD CARGO DOOR	51 x 48 IN (1.30 x 1.22 M)	35 x 48 IN (0.89 x 1.22 M)
AFT CARGO DOOR	48 x 48 IN (1.22 x 1.22 M)	33 x 48 IN (0.84 x 1.22 M)

NOTE: SEE SEC 2.7.1 FOR DOOR LOCATIONS

3.0 AIRPLANE PERFORMANCE

3.1 GENERAL INFORMATION

The graphs in Section 3.2 provide information on payload-range capability of the 737 MAX airplane. To use these graphs, if the trip range and zero fuel weight (OEW + payload) are known, the approximate takeoff weight can be found, limited by maximum zero fuel weight, maximum design takeoff weight, or fuel capacity.

The graphs in Section 3.3 provide information on FAA/EASA takeoff runway length requirements with typical engines at different pressure altitudes. Maximum takeoff weights shown on the graphs are the heaviest for the particular airplane models with the corresponding engines. Standard day temperatures for pressure altitudes shown on the FAA/EASA takeoff graphs are given below:

PRESSURE ALTITUDE		STANDARD DAY TEMP	
FEET	METERS	°F	°C
0	0	59.0	15.0
2,000	610	51.9	11.0
4,000	1,219	44.7	7.1
6,000	1,829	37.6	3.1
8,000	2,438	30.5	-0.8
10,000	3,048	23.3	-4.8
12,000	3,658	16.2	-8.8
14,000	4,267	9.1	-12.7
15,500	4,724	3.7	-15.7

The graphs in Section 3.4 provide information on landing runway length requirements for different airplane weights and airport altitudes. The maximum landing weights shown are the heaviest for the particular airplane model.

3.2 PAYLOAD/RANGE FOR LONG RANGE CRUISE

3.2.1 Payload/Range for Long Range Cruise: Model 737-7

**Payload/Range
737-7 (LEAP-1B Series)**

- STANDARD DAY, ZERO WIND
- CRUISE MACH = LRC
- NORMAL POWER EXTRACTION AND AIR CONDITIONING BLEEDS
- TYPICAL MISSION RULES
- CONSULT USING AIRLINE FOR SPECIFIC OPERATING PROCEDURE AND OEW PRIOR TO FACILITY DESIGN

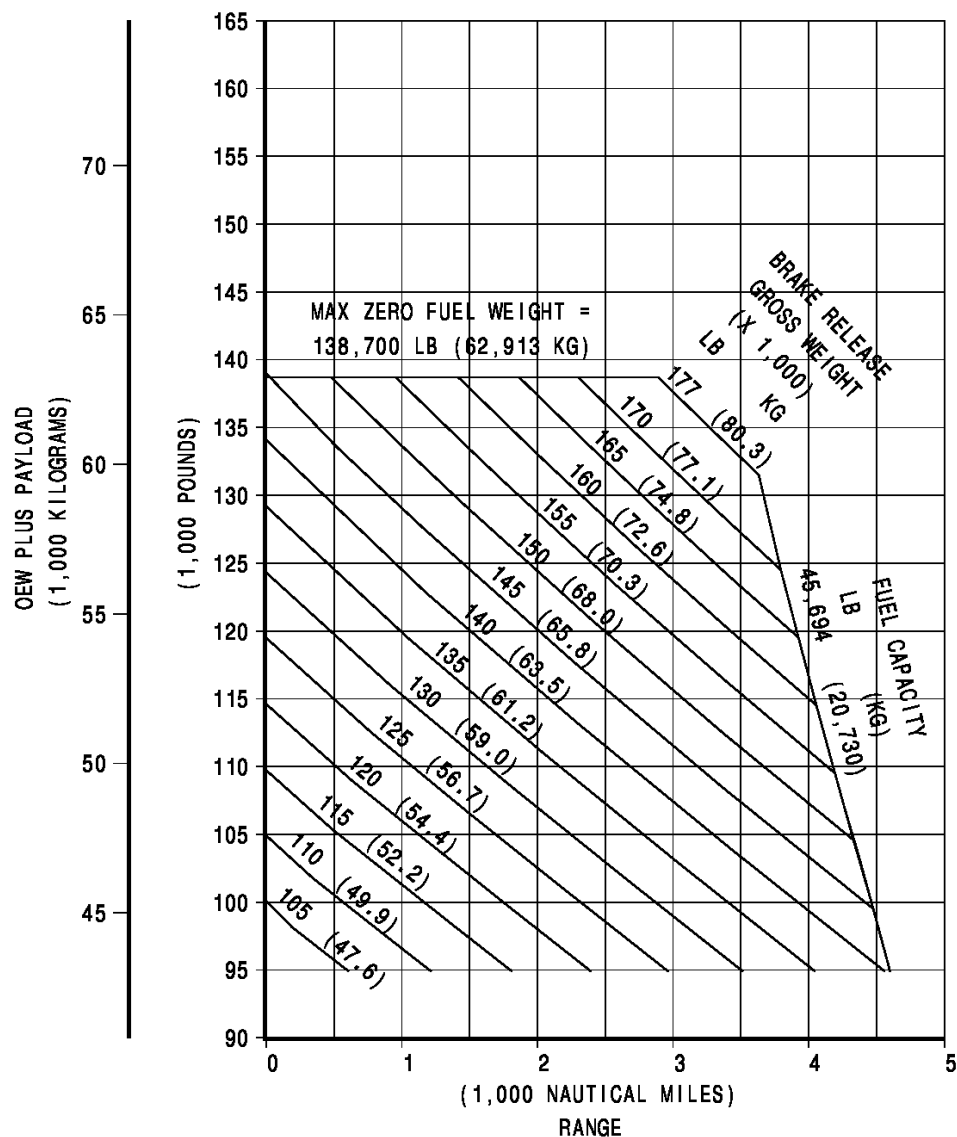

3.2.2 Payload/Range for Long Range Cruise: Model BBJ MAX 7

Payload/Range
BBJ MAX 7 (LEAP-1B Series)

- STANDARD DAY, ZERO WIND
- CRUISE MACH = LRC
- NORMAL POWER EXTRACTION AND AIR CONDITIONING BLEEDS
- TYPICAL MISSION RULES
- CONSULT USING AIRLINE FOR SPECIFIC OPERATING PROCEDURE AND OEW PRIOR TO FACILITY DESIGN.

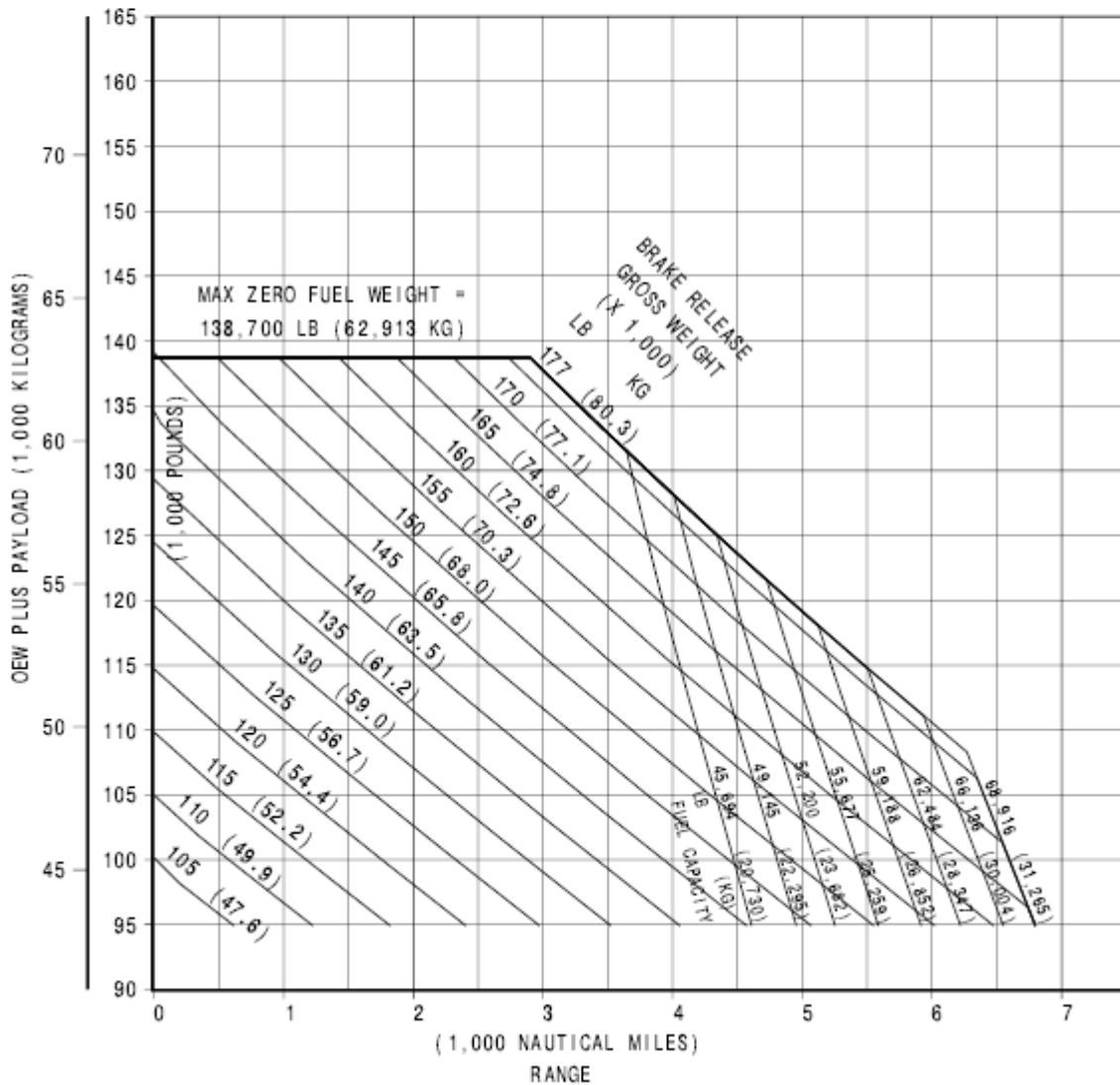

3.2.3 Payload/Range for Long Range Cruise: Model 737-8 / -8-200

Payload / Range
737-8 / -8-200 (LEAP-1B Series)

- STANDARD DAY, ZERO WIND
- CRUISE MACH = LRC
- NORMAL POWER EXTRACTION AND AIR CONDITIONING BLEEDS
- TYPICAL MISSION RULES
- CONSULT USING AIRLINE FOR SPECIFIC OPERATING PROCEDURE AND OEW PRIOR TO FACILITY DESIGN

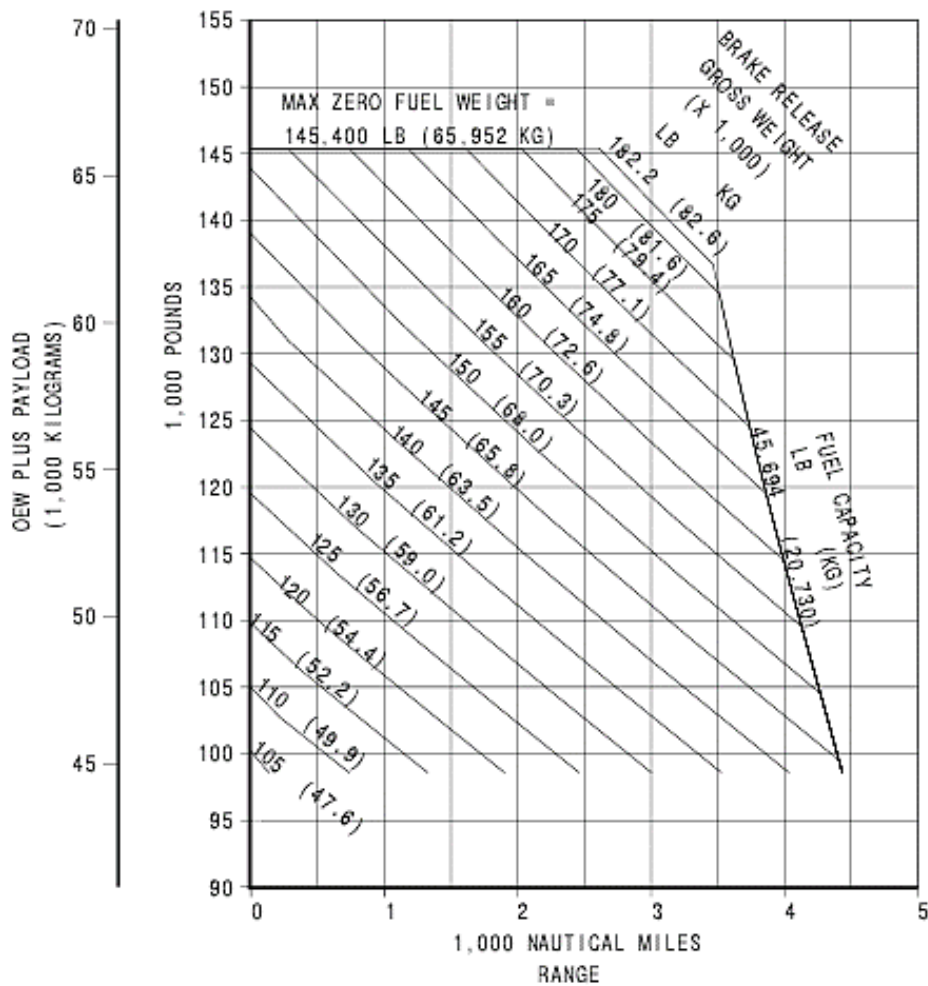

3.2.4 Payload/Range for Long Range Cruise: Model BBJ MAX 8

Payload/Range
BBJ MAX 8 (LEAP-1B Series)

- STANDARD DAY, ZERO WIND
- CRUISE MACH = LRC
- NORMAL POWER EXTRACTION AND AIR CONDITIONING BLEEDS
- TYPICAL MISSION RULES
- CONSULT USING AIRLINE FOR SPECIFIC OPERATING PROCEDURE AND OEW PRIOR TO FACILITY DESIGN

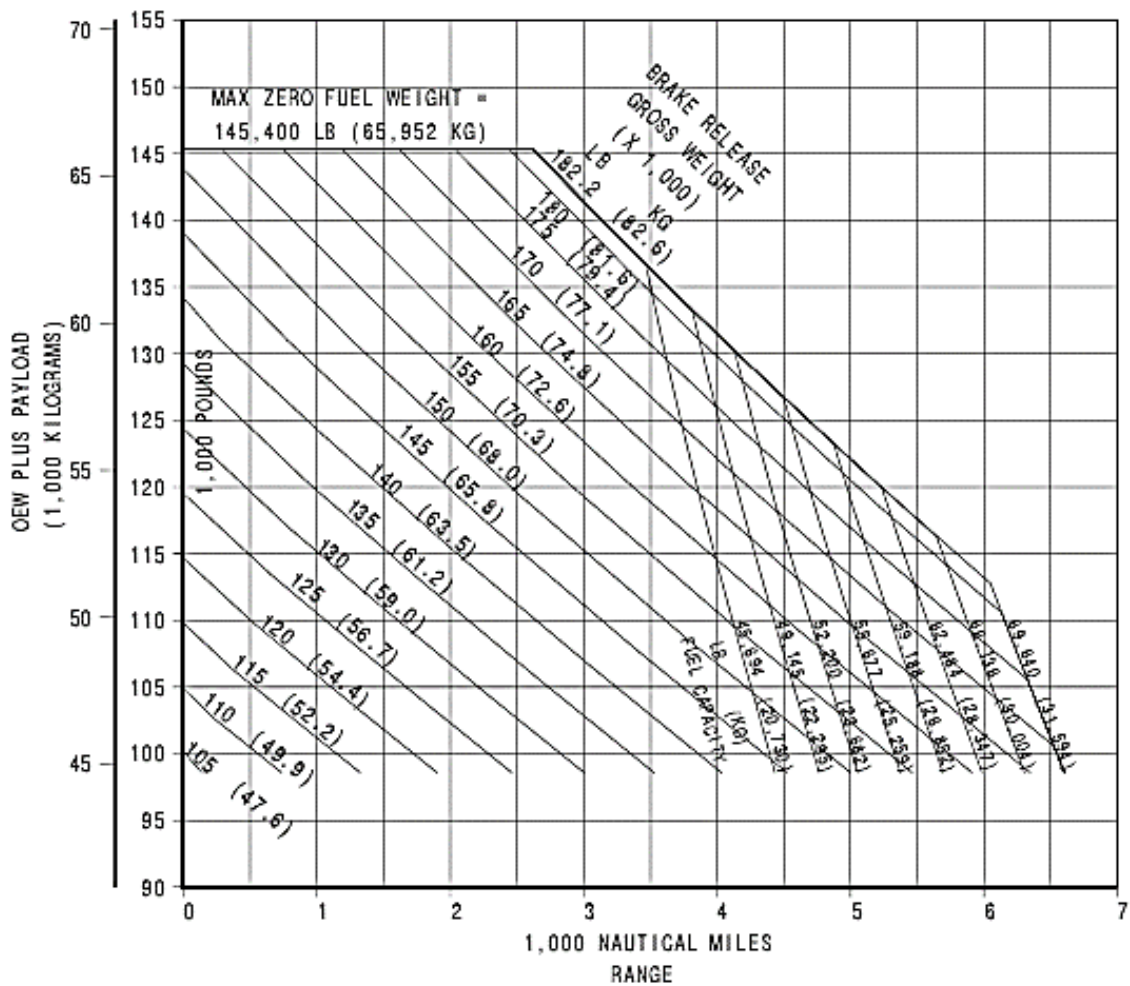

3.2.5 Payload/Range for Long Range Cruise: Model 737-9

**Payload/Range
737-9 (LEAP-1B Series)**

- STANDARD DAY, ZERO WIND
- CRUISE MACH = LRC
- NORMAL POWER EXTRACTION AND AIR CONDITIONING BLEEDS
- TYPICAL MISSION RULES
- CONSULT USING AIRLINE FOR SPECIFIC OPERATING PROCEDURE AND OEW PRIOR TO FACILITY DESIGN

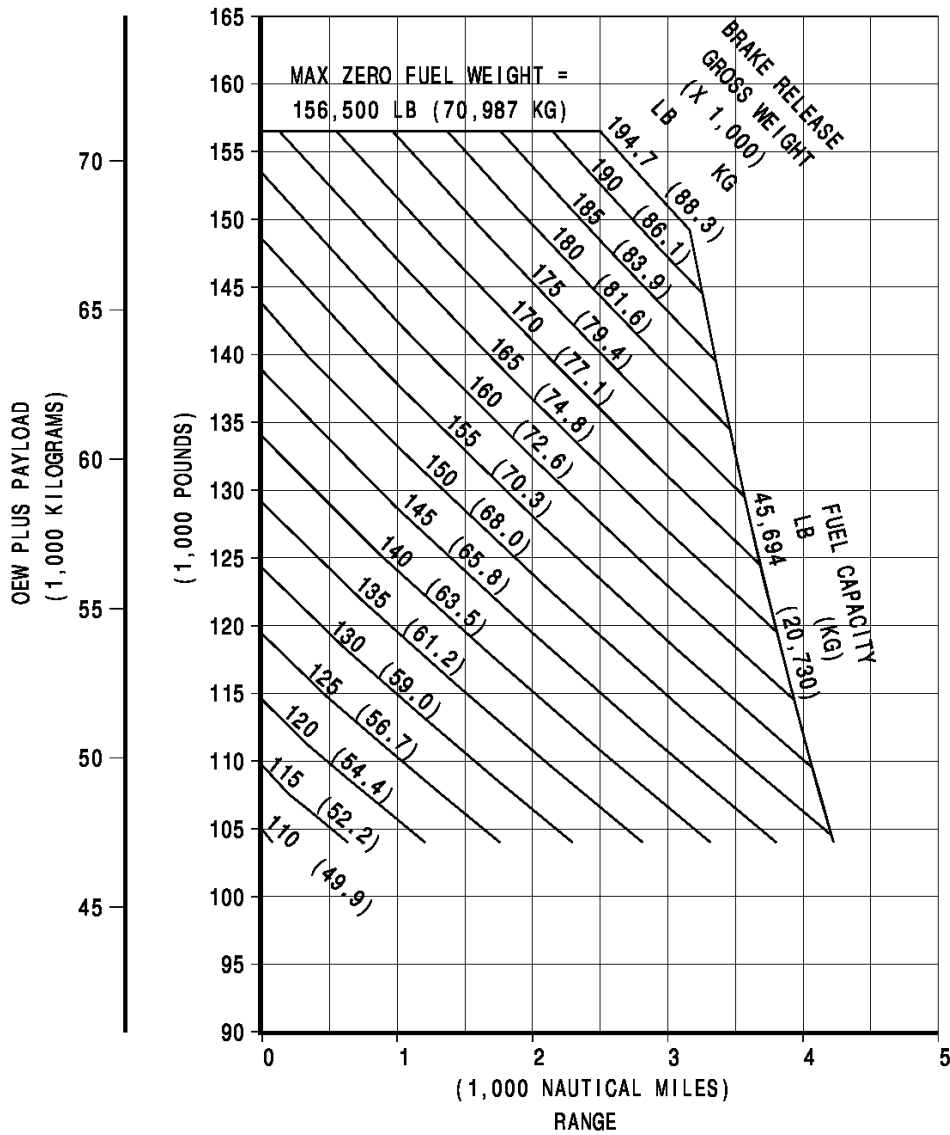

3.2.6 Payload/Range for Long Range Cruise: Model BBJ MAX 9

Payload/Range
BBJ MAX 9 (LEAP-1B Series)

- STANDARD DAY, ZERO WIND
- CRUISE MACH = LRC
- NORMAL POWER EXTRACTION AND AIR CONDITIONING BLEEDS
- TYPICAL MISSION RULES
- CONSULT USING AIRLINE FOR SPECIFIC OPERATING PROCEDURE AND OEW PRIOR TO FACILITY DESIGN.

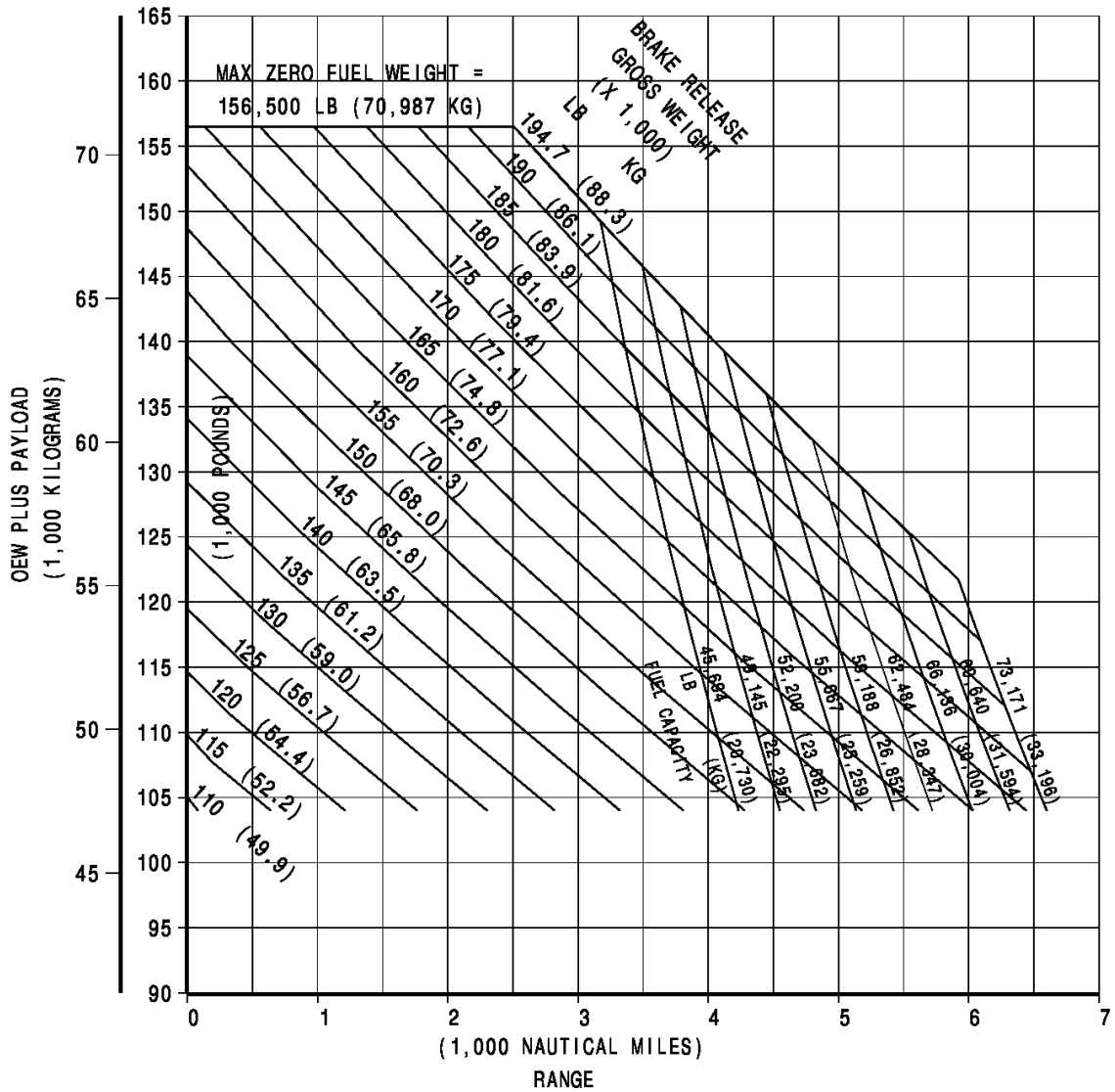

D6-38A004

3.3 FAA/EASA TAKEOFF RUNWAY LENGTH REQUIREMENTS

3.3.1 FAA/EASA Takeoff Runway Length Requirements - Standard Day, Dry Runway: Model 737-7 (LEAP-1B25 Engine)

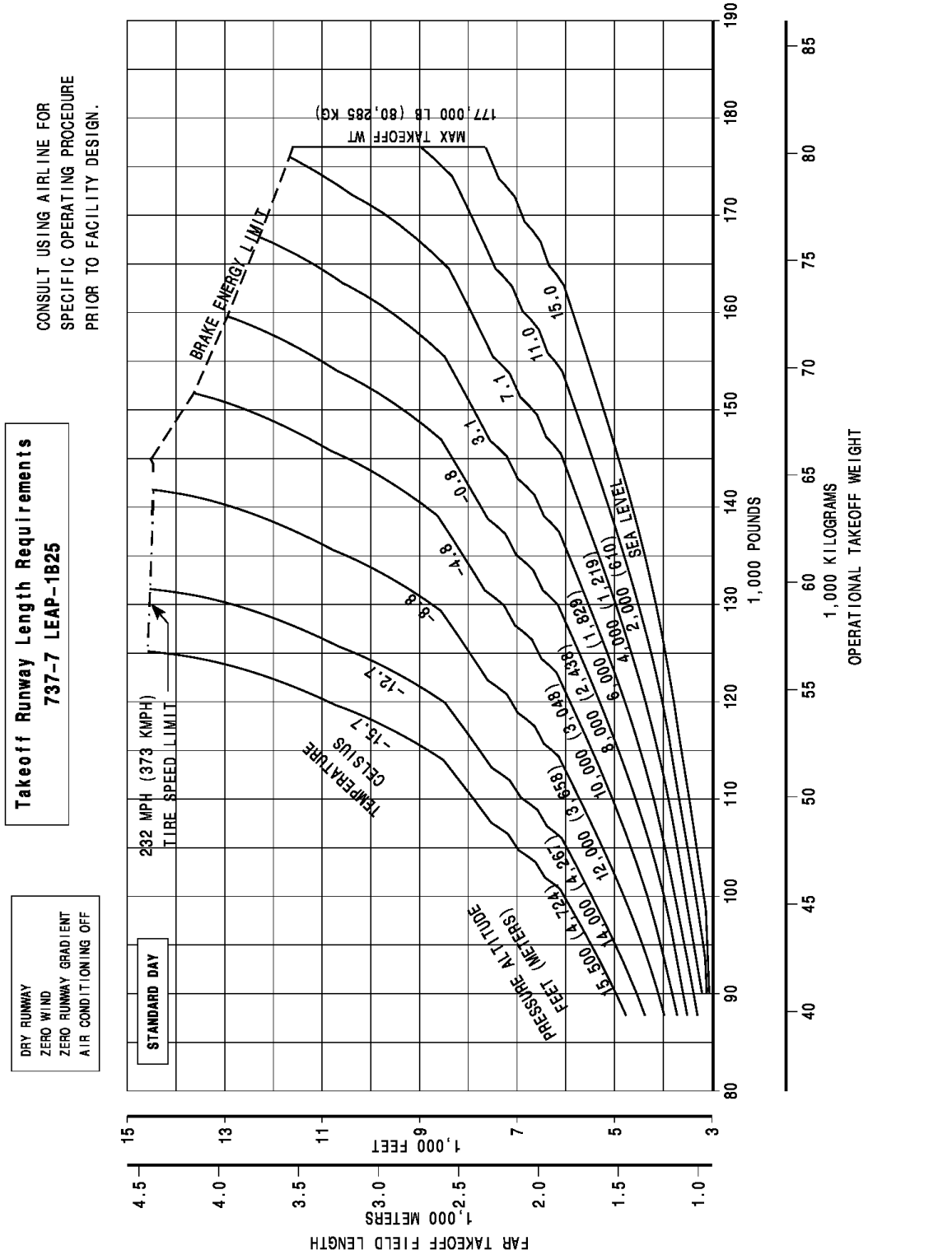

3.3.2 FAA/EASA Takeoff Runway Length Requirements - Standard Day + 27°F (STD + 15°C), Dry Runway: Model 737-7 (LEAP-1B25 Engine)

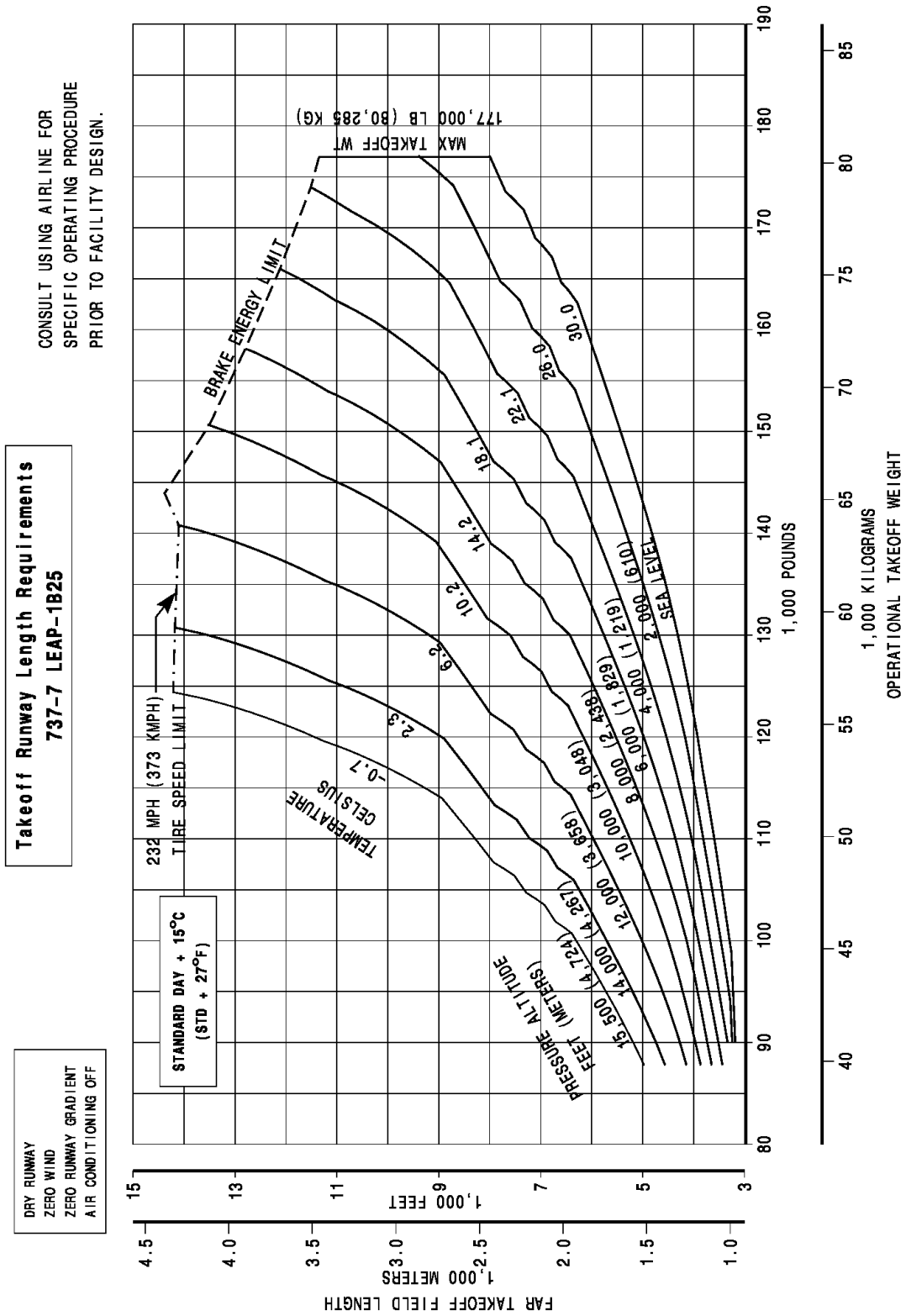

D6-38A004

3.3.3 FAA/EASA Takeoff Runway Length Requirements - Standard Day + 45°F (STD + 25°C), Dry Runway: Model 737-7 (LEAP-1B25 Engine)

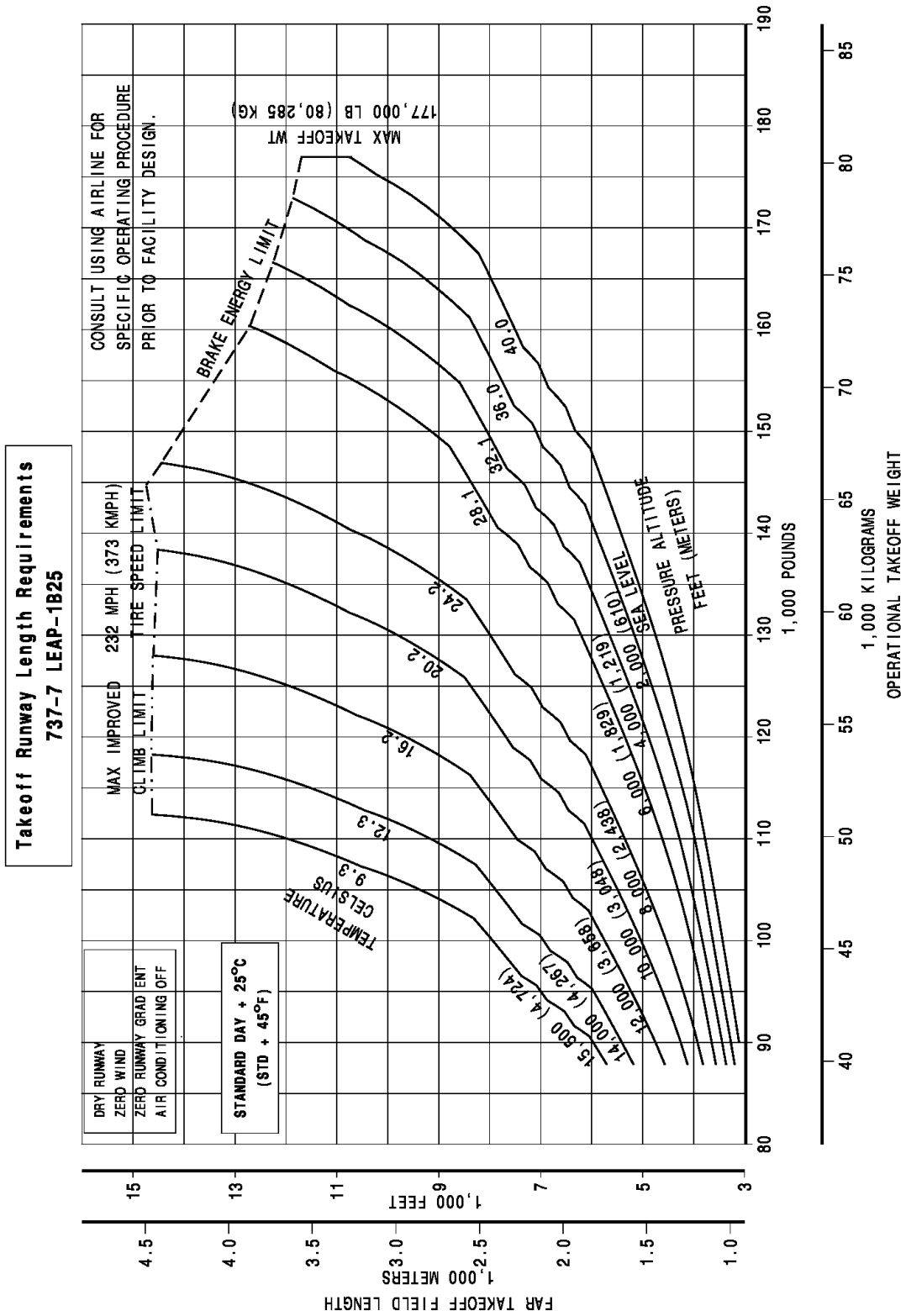

3.3.4 FAA/EASA Takeoff Runway Length Requirements - Standard Day + 63°F (STD + 35 °C), Dry Runway: Model 737-7 (LEAP-1B25 Engine)

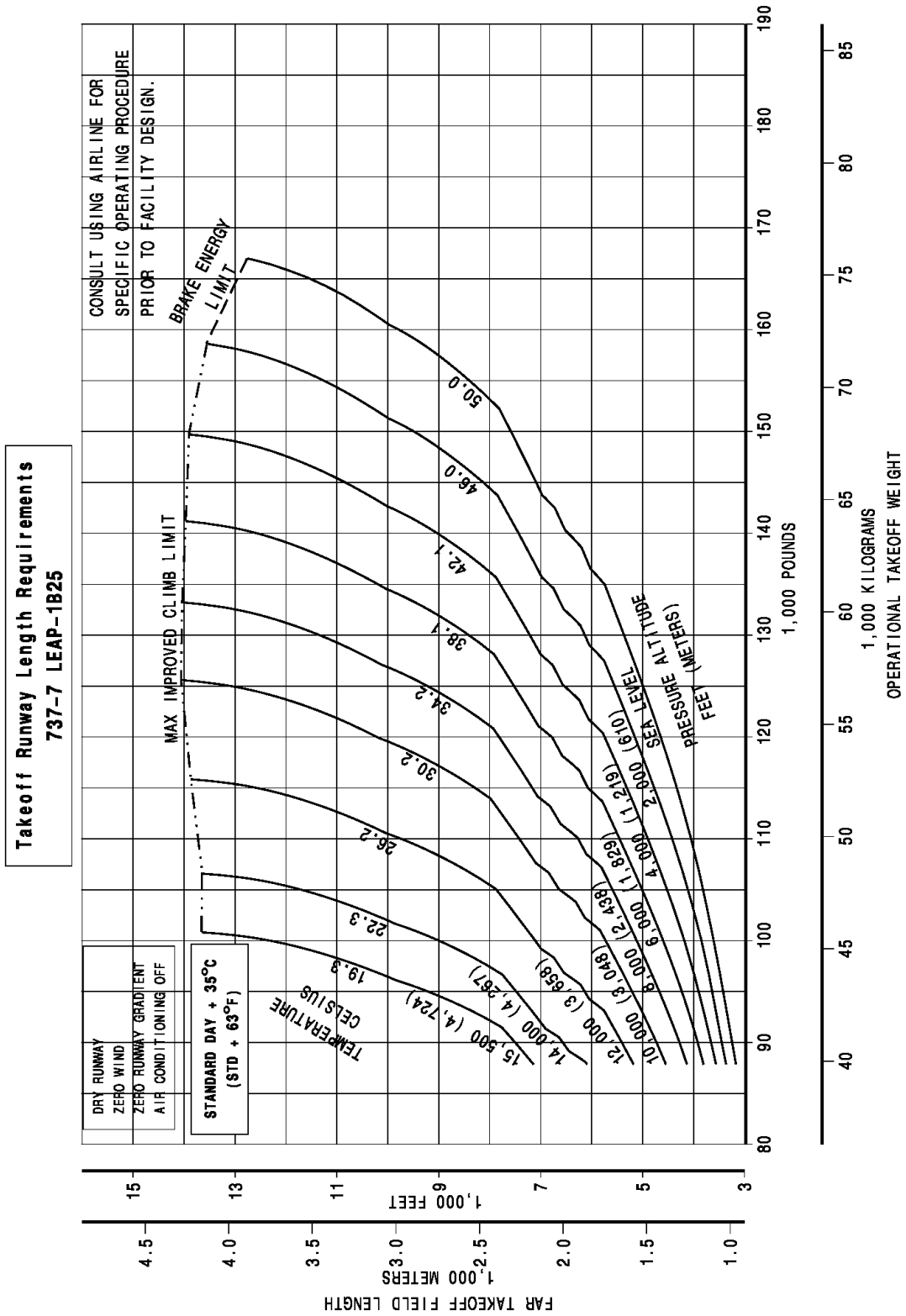

3.3.5 FAA/EASA Takeoff Runway Length Requirements - Standard Day, Dry Runway: Model 737-7 (LEAP-1B28B2C Engine)

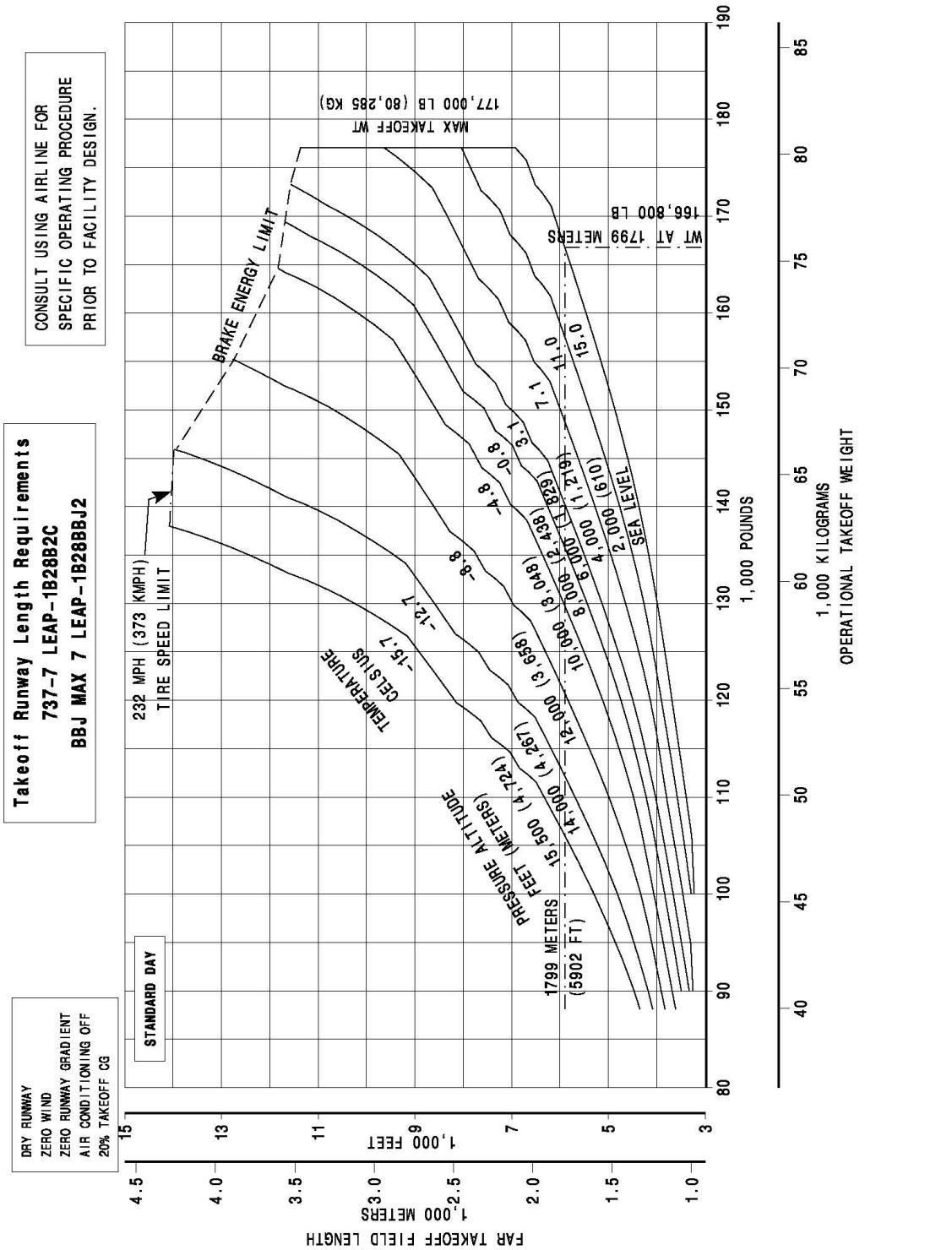

3.3.6 FAA/EASA Takeoff Runway Length Requirements - Standard Day + 27°F (STD + 15°C), Dry Runway: Model 737-7 (LEAP-1B28B2C Engine)

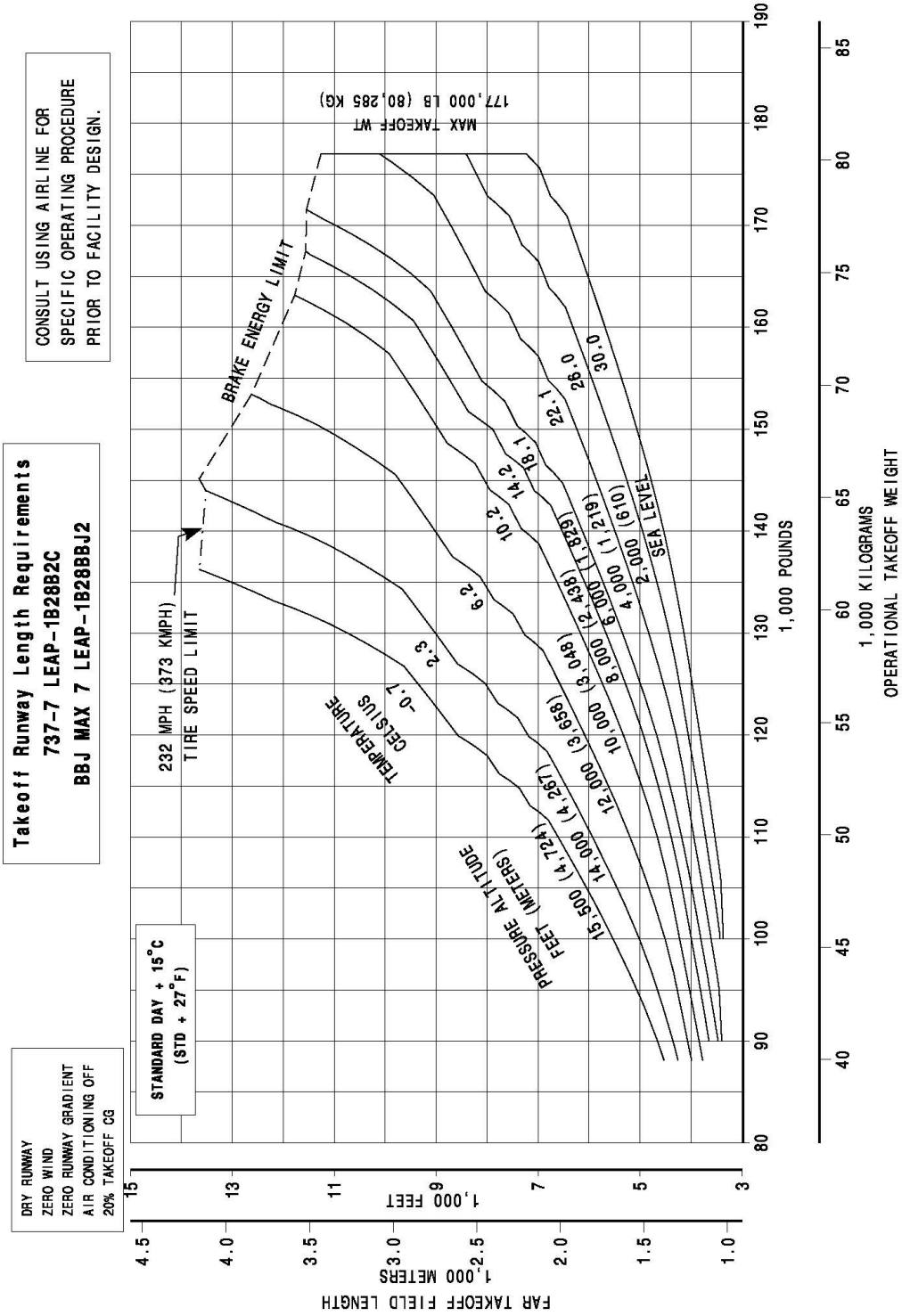

3.3.7 FAA/EASA Takeoff Runway Length Requirements - Standard Day + 45°F (STD + 25°C), Dry Runway: Model 737-7 (LEAP-1B28B2C Engine)

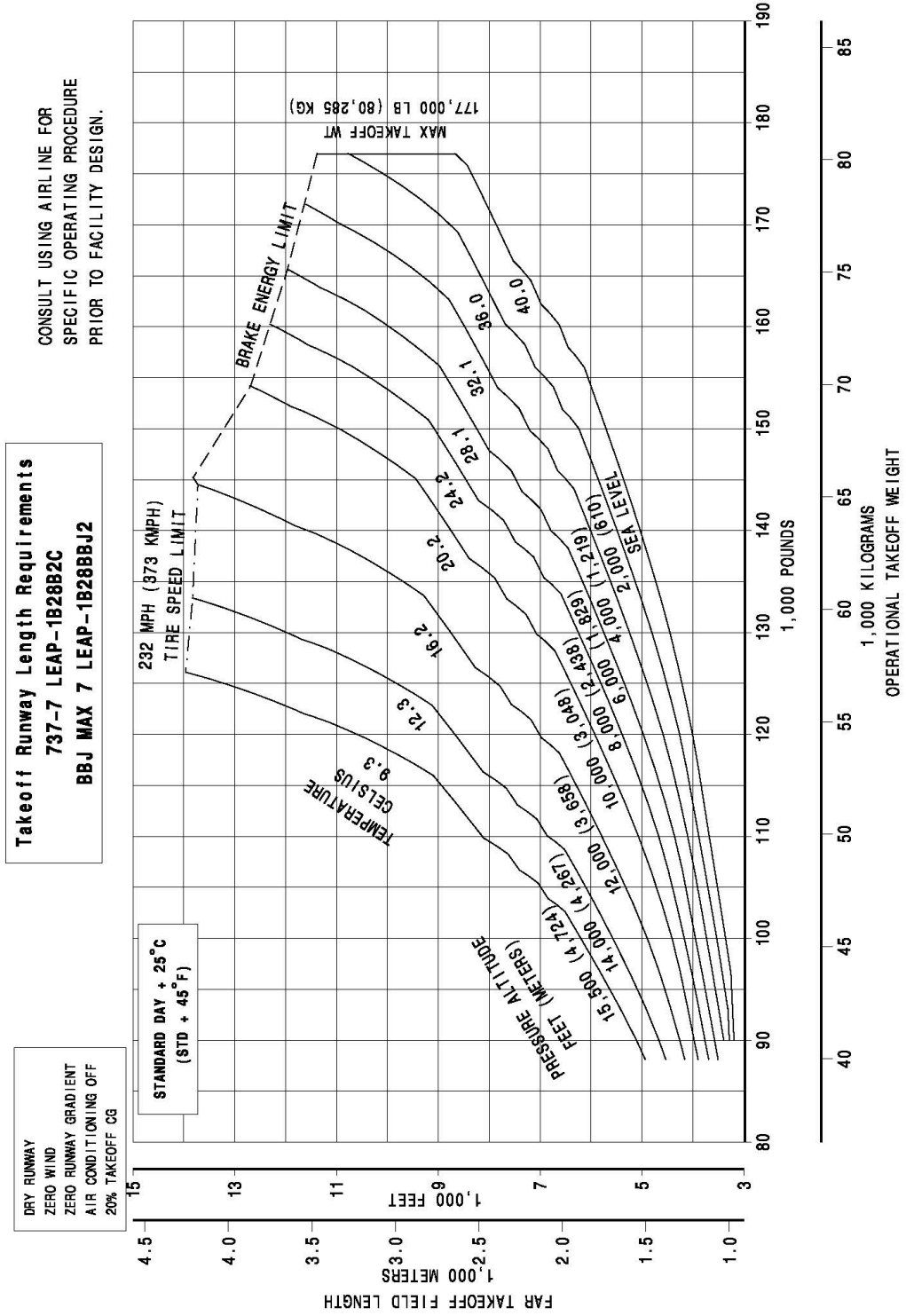

3.3.8 FAA/EASA Takeoff Runway Length Requirements - Standard Day + 63°F (STD + 35 °C), Dry Runway: Model 737-7 (LEAP-1B28B2C Engine)

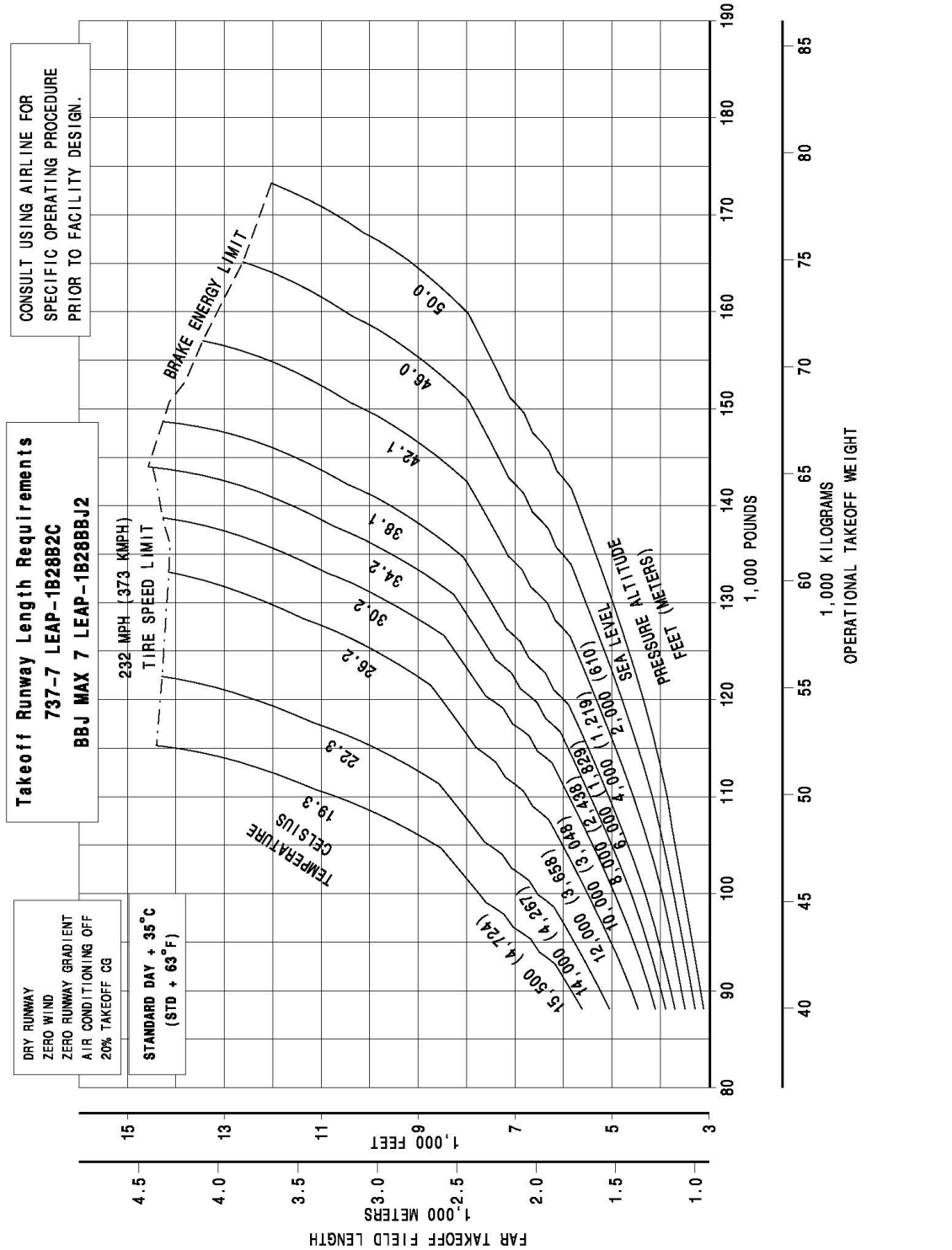

D6-38A004

3.3.9 FAA/EASA Takeoff Runway Length Requirements - Standard Day, Dry Runway: Model 737-8 / -8-200 (LEAP-1B25 Engine)

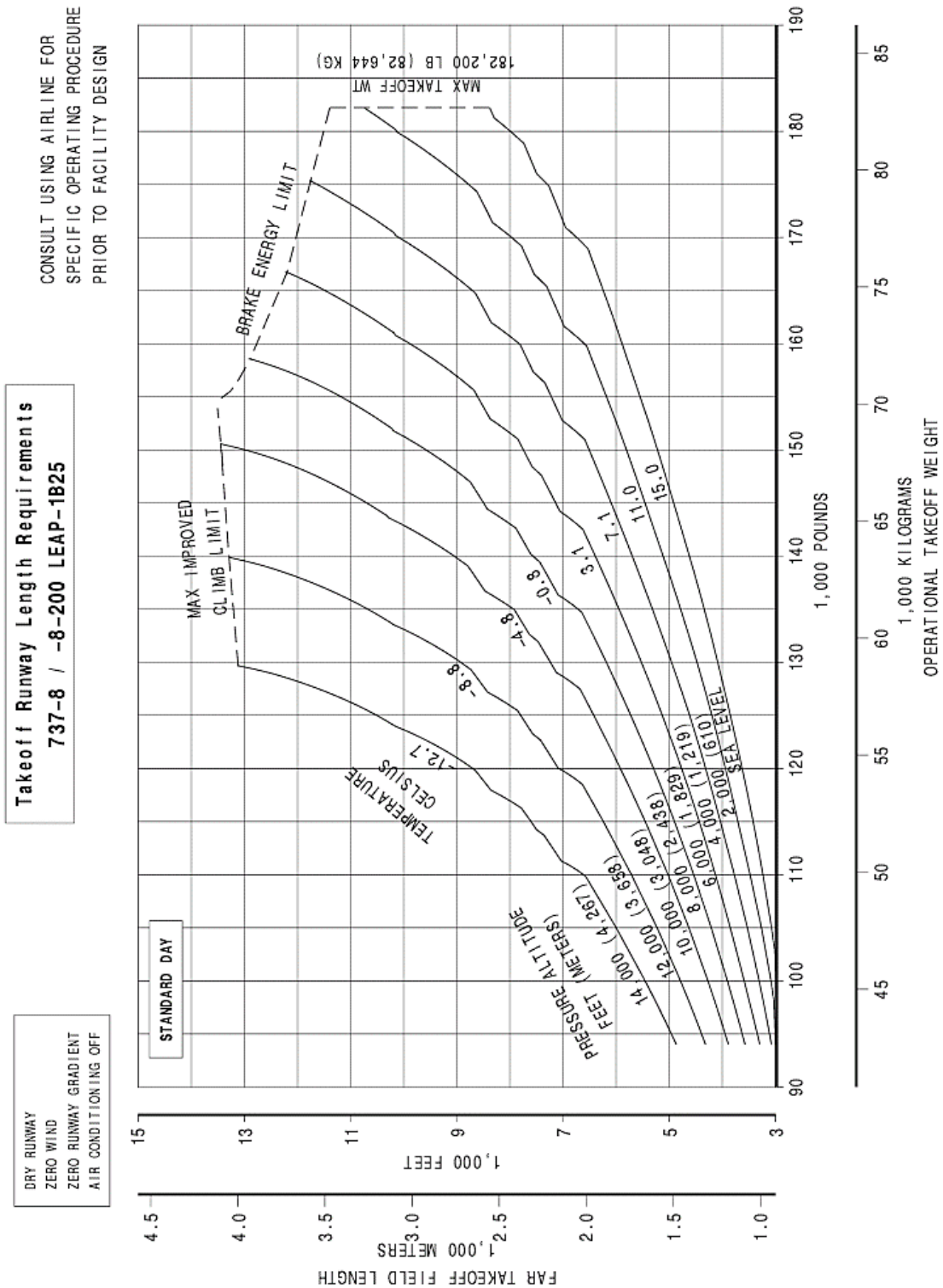

D6-38A004

3.3.10 FAA/EASA Takeoff Runway Length Requirements - Standard Day + 27°F (STD + 15°C), Dry Runway: Model 737-8 / -8-200 (LEAP-1B25 Engine)

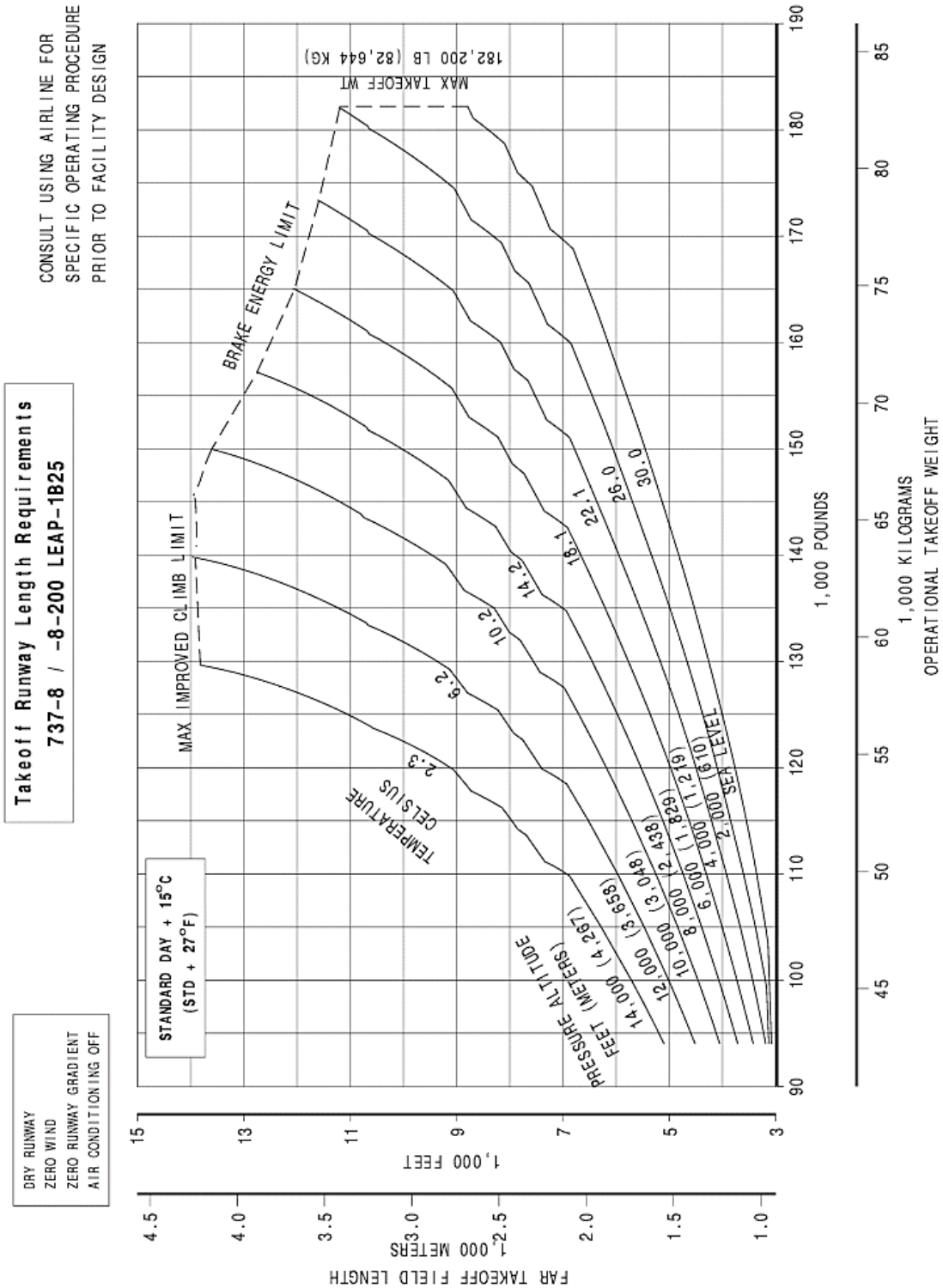

3.3.11 FAA/EASA Takeoff Runway Length Requirements - Standard Day + 45°F (STD + 25°C), Dry Runway: Model 737-8 / -8-200 (LEAP-1B25 Engine)

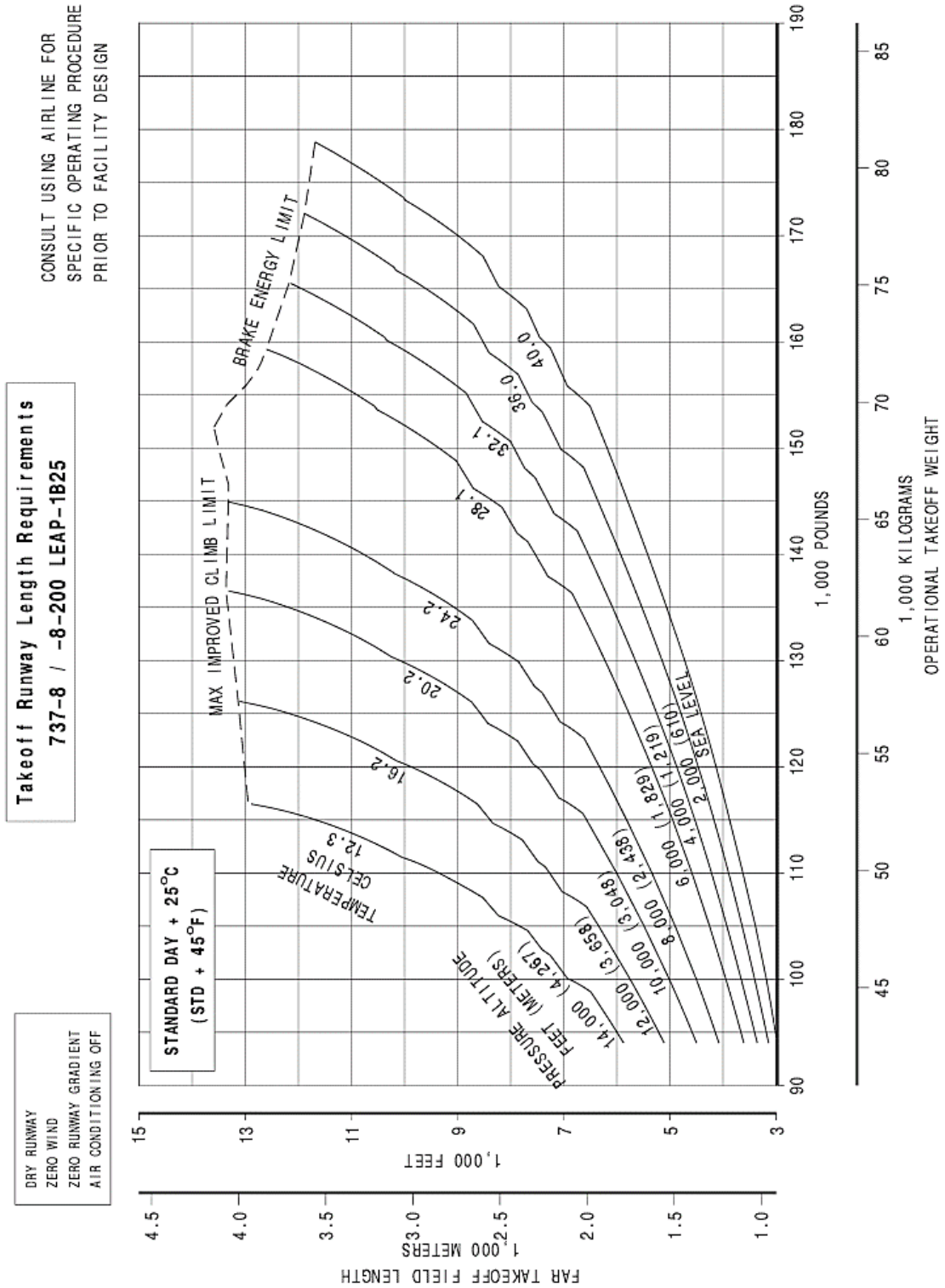

D6-38A004

3.3.12 FAA/EASA Takeoff Runway Length Requirements - Standard Day + 63°F (STD + 35 °C), Dry Runway: Model 737-8 / -8-200 (LEAP-1B25 Engine)

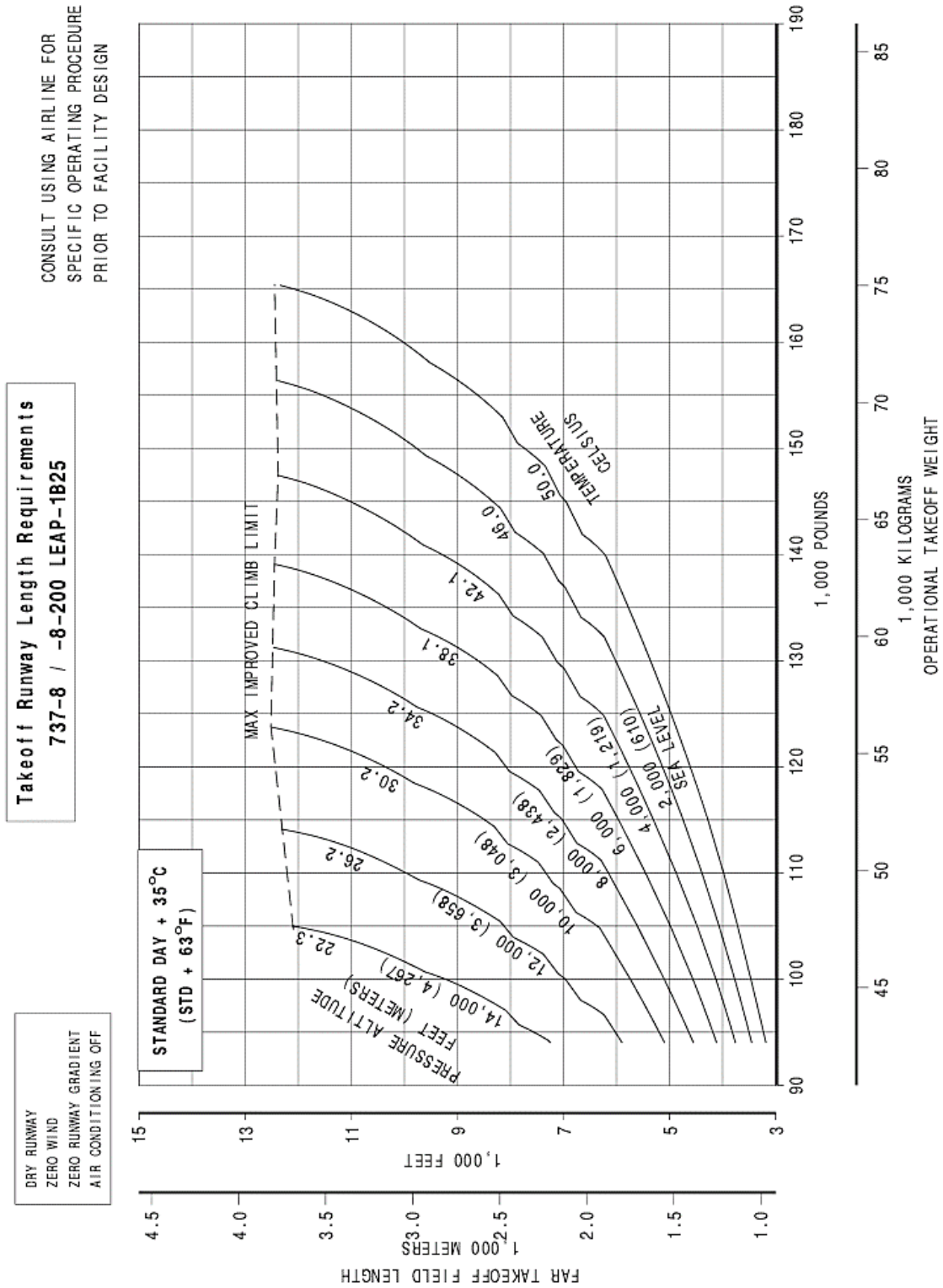

D6-38A004

**3.3.13 FAA/EASA Takeoff Runway Length Requirements - Standard Day,
Dry Runway: Model 737-8 / -8-200 / BBJ MAX 8 (LEAP-1B28B1 /
LEAP-1B28BBJ1 Engines)**

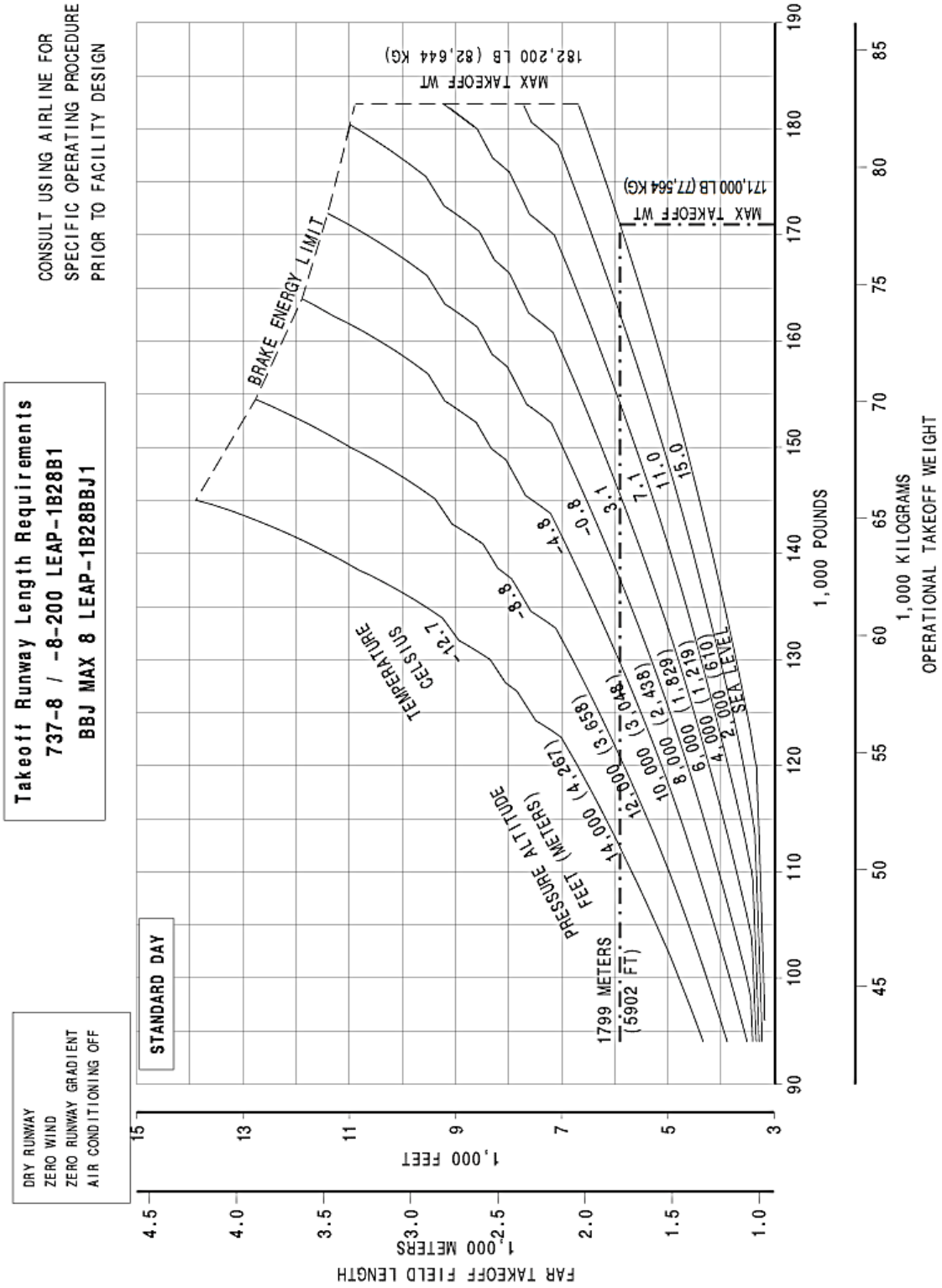

D6-38A004

3.3.15 FAA/EASA Takeoff Runway Length Requirements - Standard Day + 45°F (STD + 25°C), Dry Runway: Model 737-8 / -8-200 / BBJ MAX 8 (LEAP-1B28B1 / LEAP-1B28BBJ1 Engines)

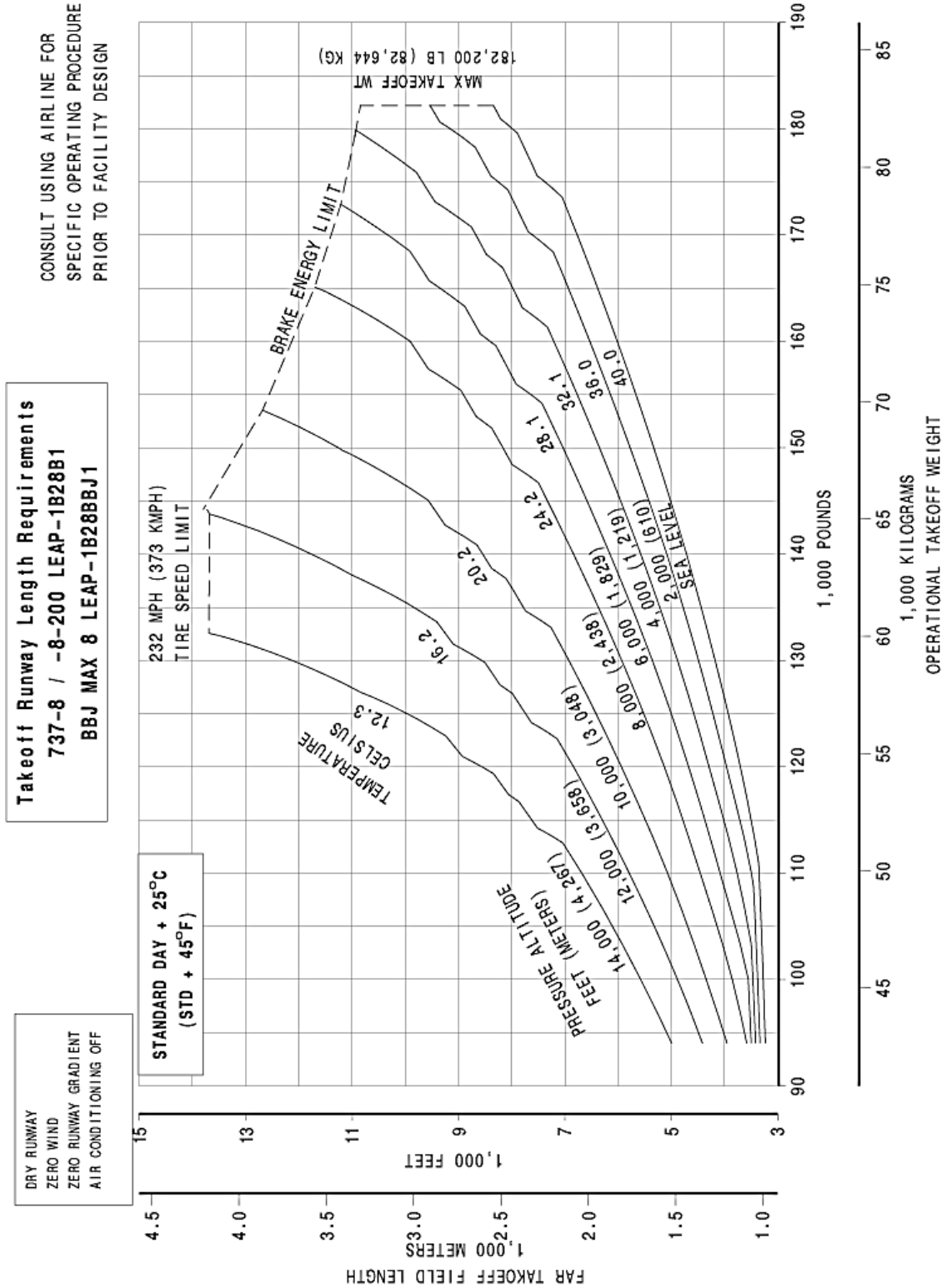

D6-38A004

3.3.16 FAA/EASA Takeoff Runway Length Requirements - Standard Day + 63°F (STD + 35 °C), Dry Runway: Model 737-8 / -8-200 / BBJ MAX 8 (LEAP-1B28B1 / LEAP-1B28BBJ1 Engines)

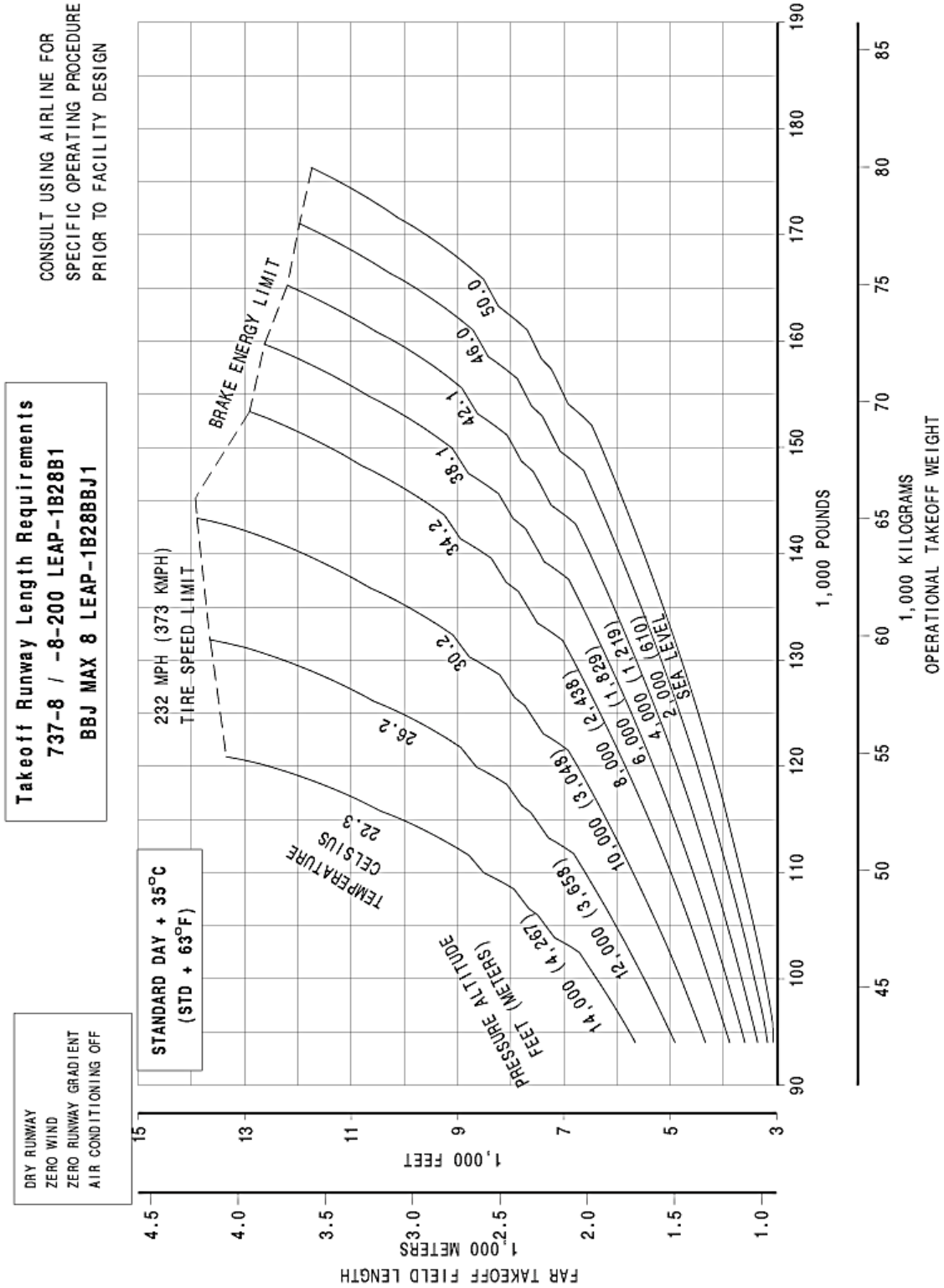

D6-38A004

3.3.17 FAA/EASA Takeoff Runway Length Requirements - Standard Day, Dry Runway: Model 737-9 (LEAP-1B27 Engine)

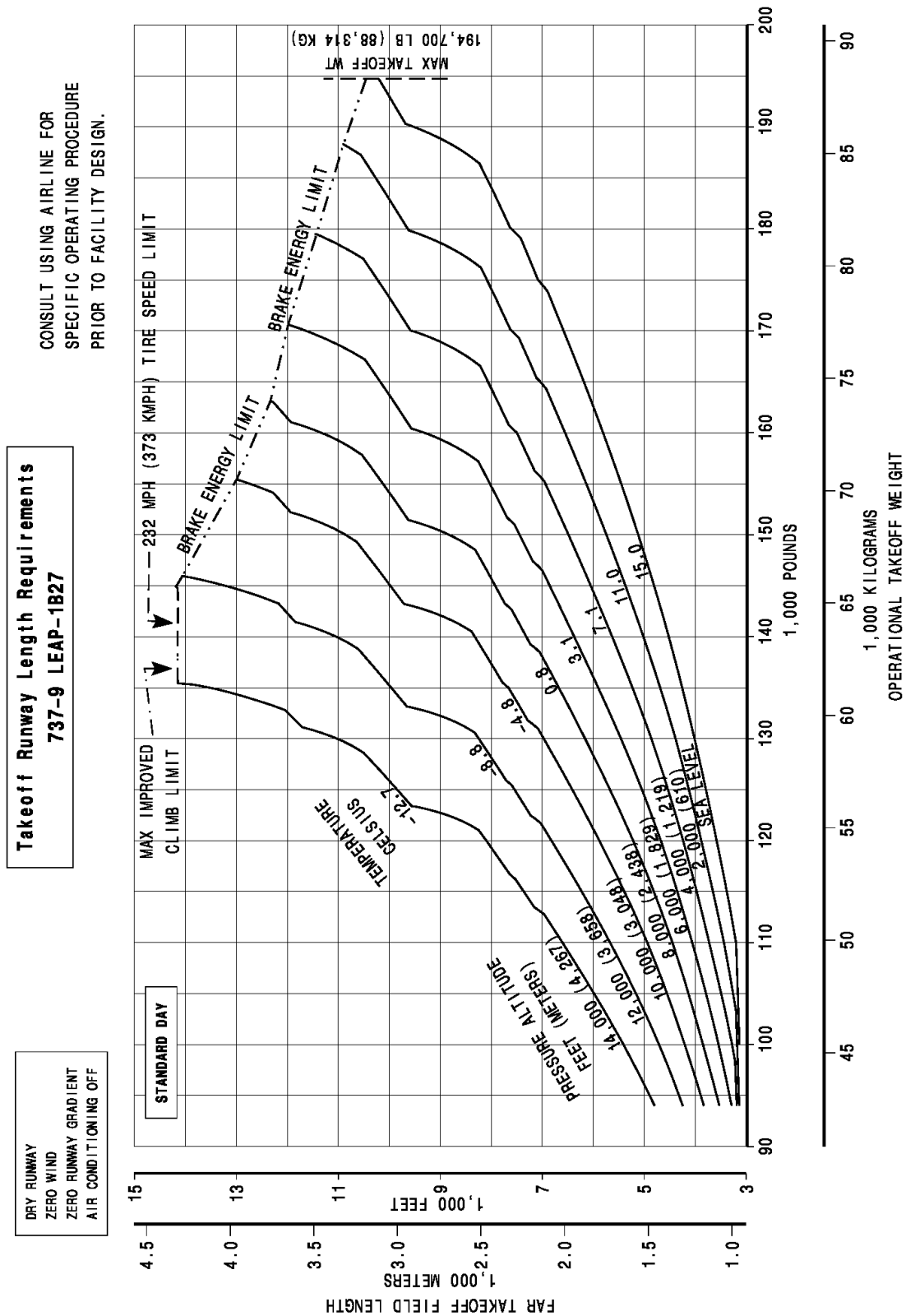

D6-38A004

3.3.18 FAA/EASA Takeoff Runway Length Requirements - Standard Day + 27°F (STD + 15°C), Dry Runway: Model 737-9 (LEAP-1B27 Engine)

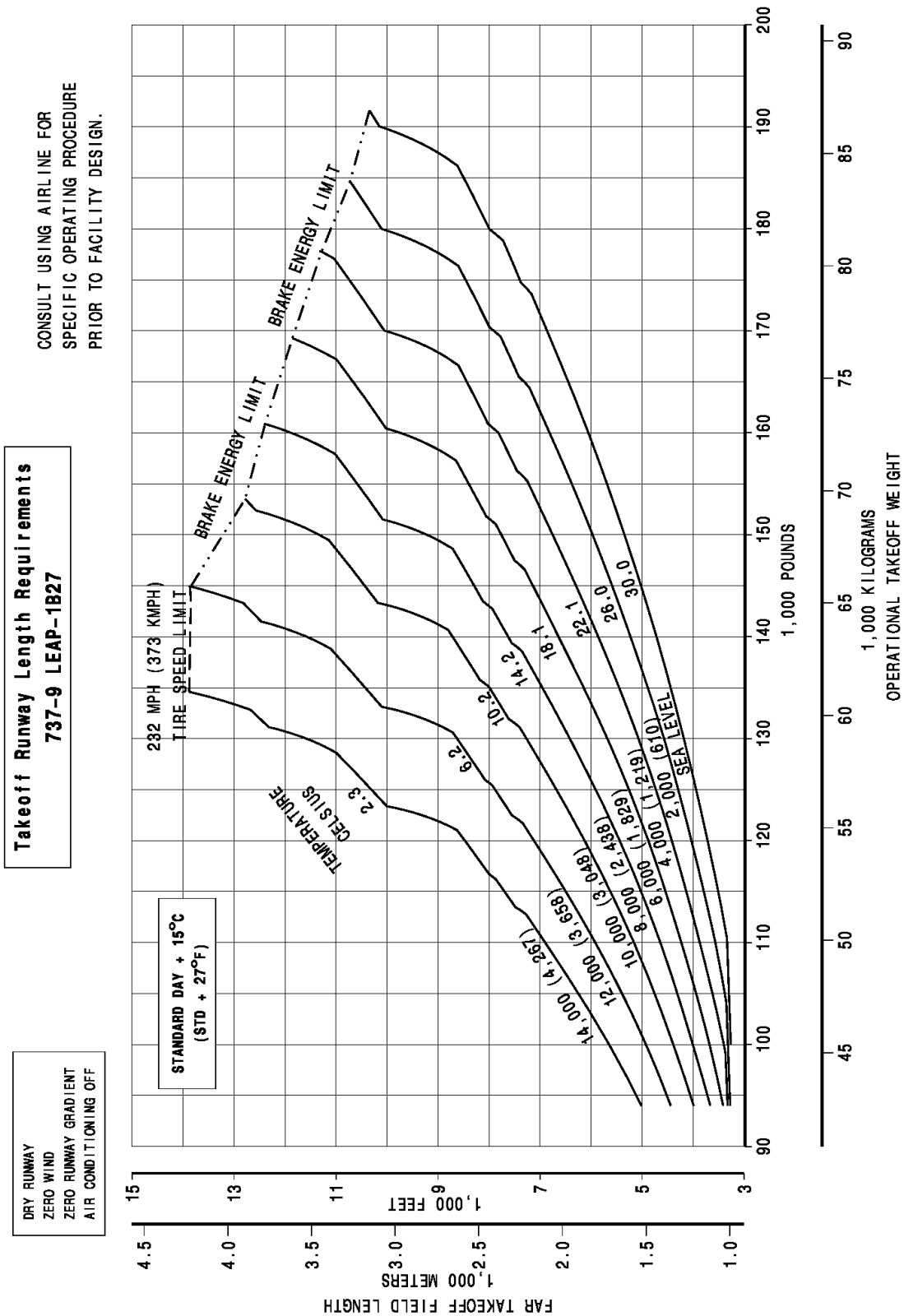

D6-38A004

3.3.19 FAA/EASA Takeoff Runway Length Requirements - Standard Day + 45°F (STD + 25°C), Dry Runway: Model 737-9 (LEAP-1B27 Engine)

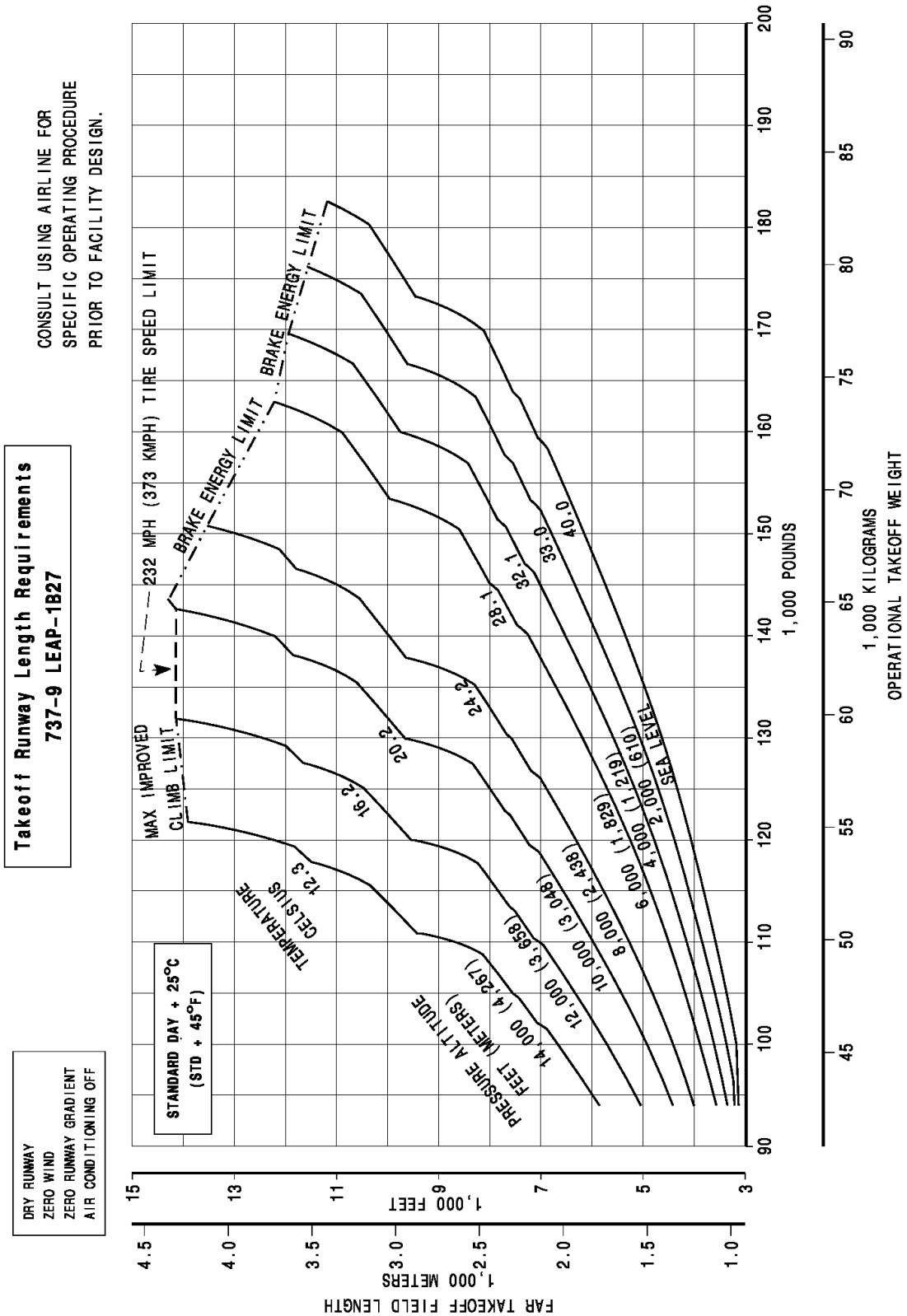

D6-38A004

3.3.20 FAA/EASA Takeoff Runway Length Requirements - Standard Day + 63°F (STD + 35 °C), Dry Runway: Model 737-9 (LEAP-1B27 Engine)

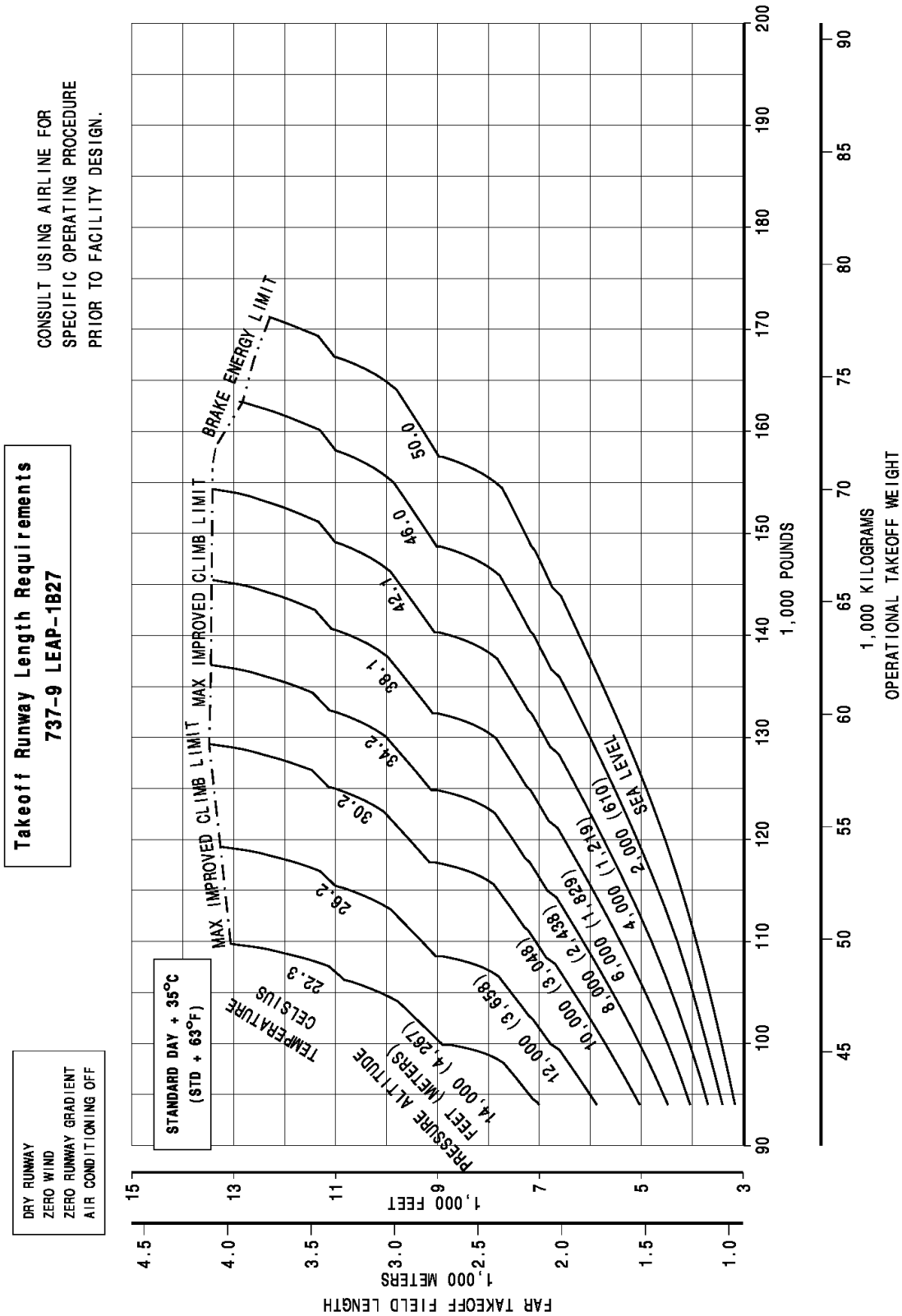

D6-38A004

3.3.21 FAA/EASA Takeoff Runway Length Requirements – Standard Day, Dry Runway: Model 737-9 / BBJ MAX 9 (LEAP-1B28 / LEAP-1B28BBJ1 Engines)

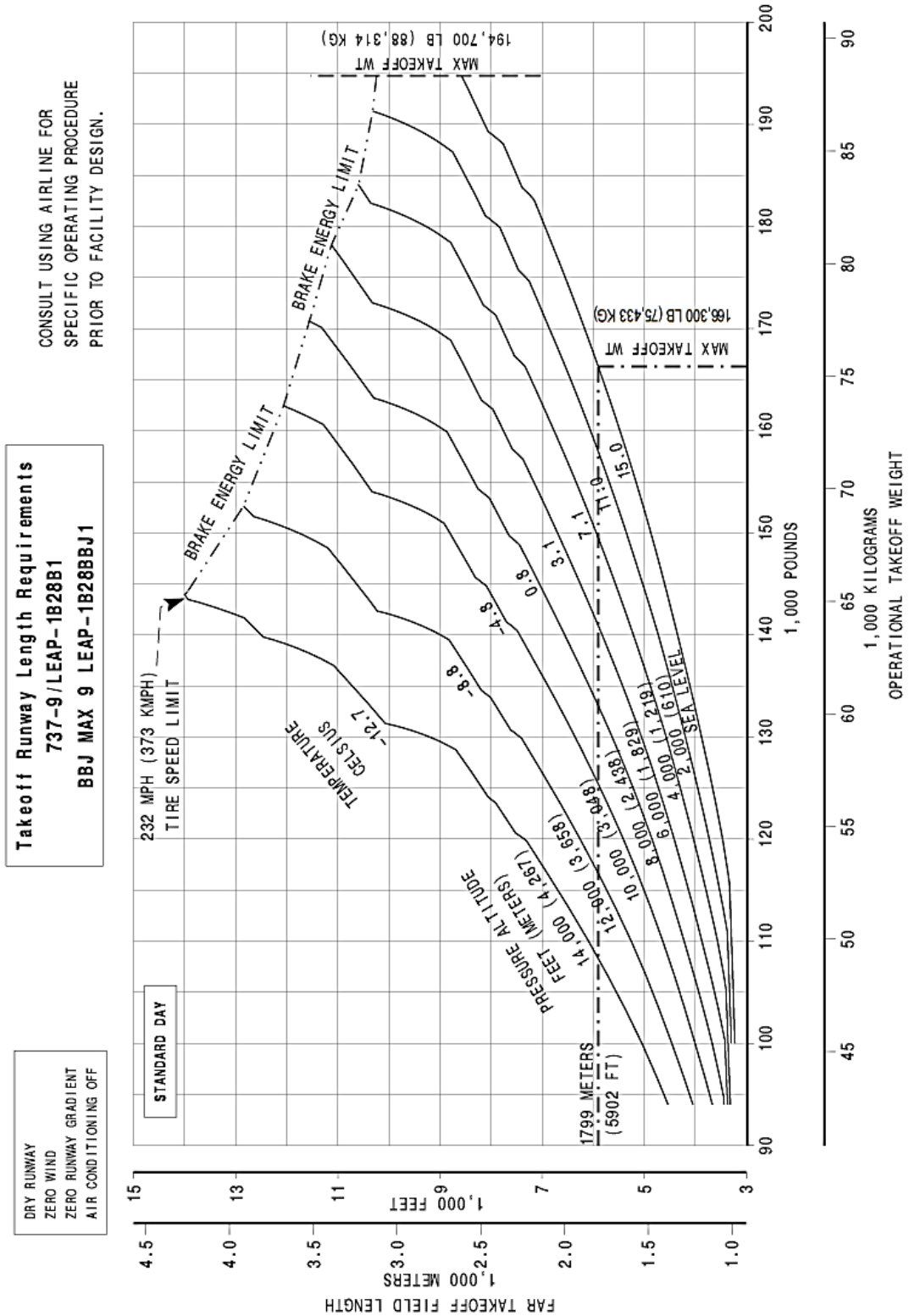

D6-38A004

3.3.22 FAA/EASA Takeoff Runway Length Requirements - Standard Day + 27°F (STD + 15°C), Dry Runway: Model 737-9 / BBJ MAX 9 (LEAP-1B28 / LEAP-1B28BBJ1 Engines)

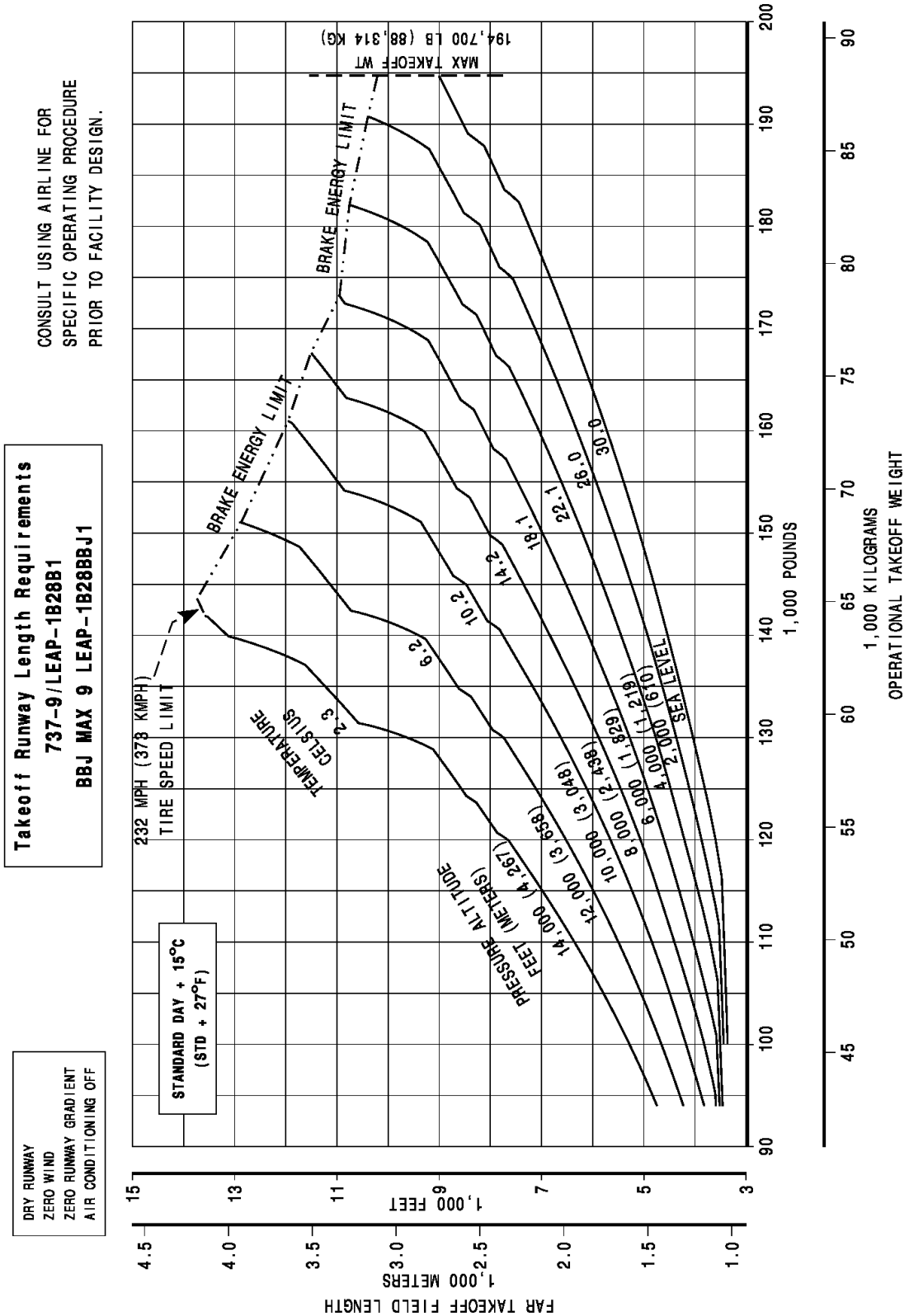

3.3.23 FAA/EASA Takeoff Runway Length Requirements - Standard Day + 45°F (STD + 25°C), Dry Runway: Model 737-9 / BBJ MAX 9 (LEAP-1B28 / LEAP-1B28BBJ1 Engines)

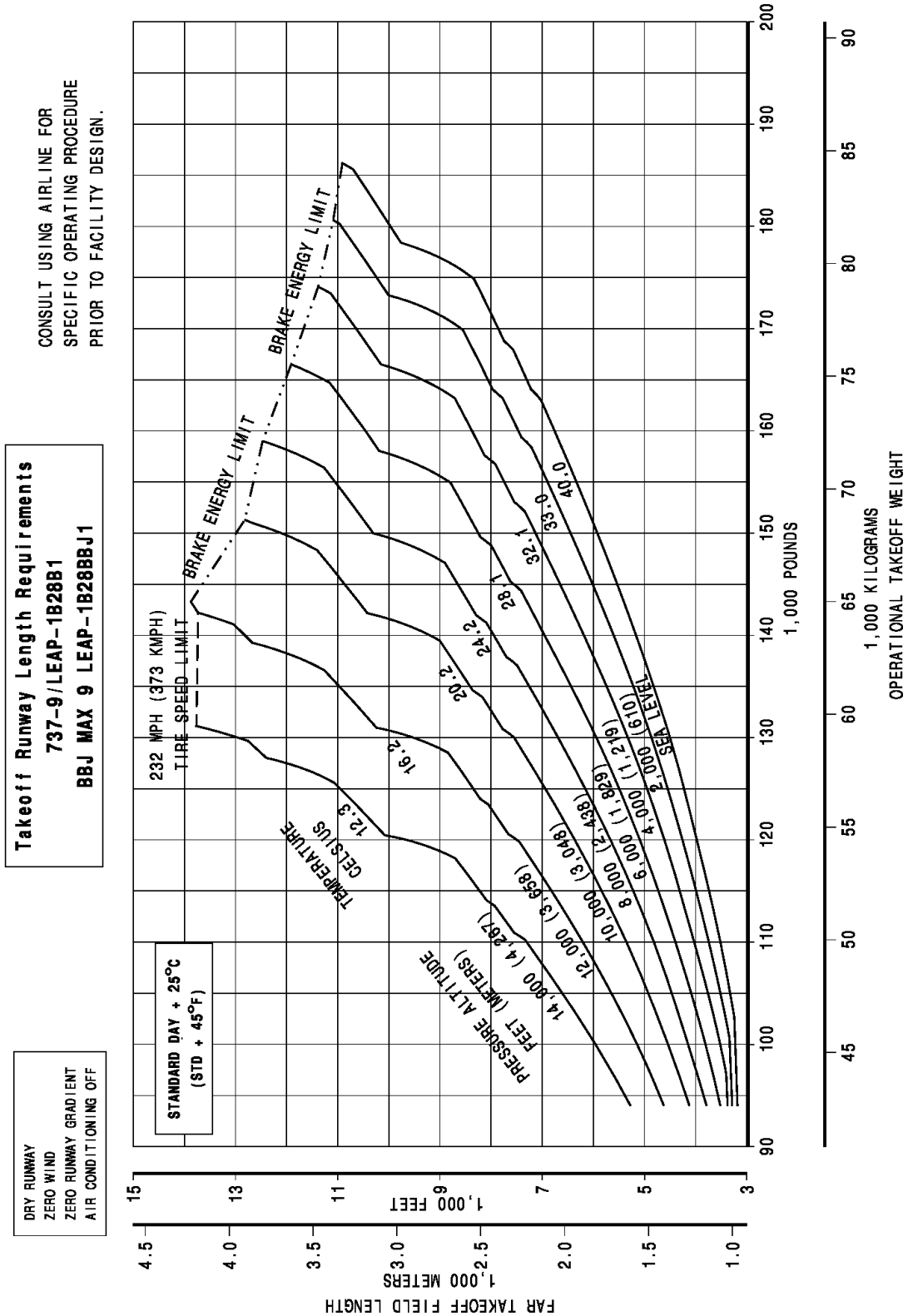

3.3.24 FAA/EASA Takeoff Runway Length Requirements - Standard Day + 63°F (STD + 35 °C), Dry Runway: Model 737-9 / BBJ MAX 9 (LEAP-1B28 / LEAP-1B28BBJ1 Engines)

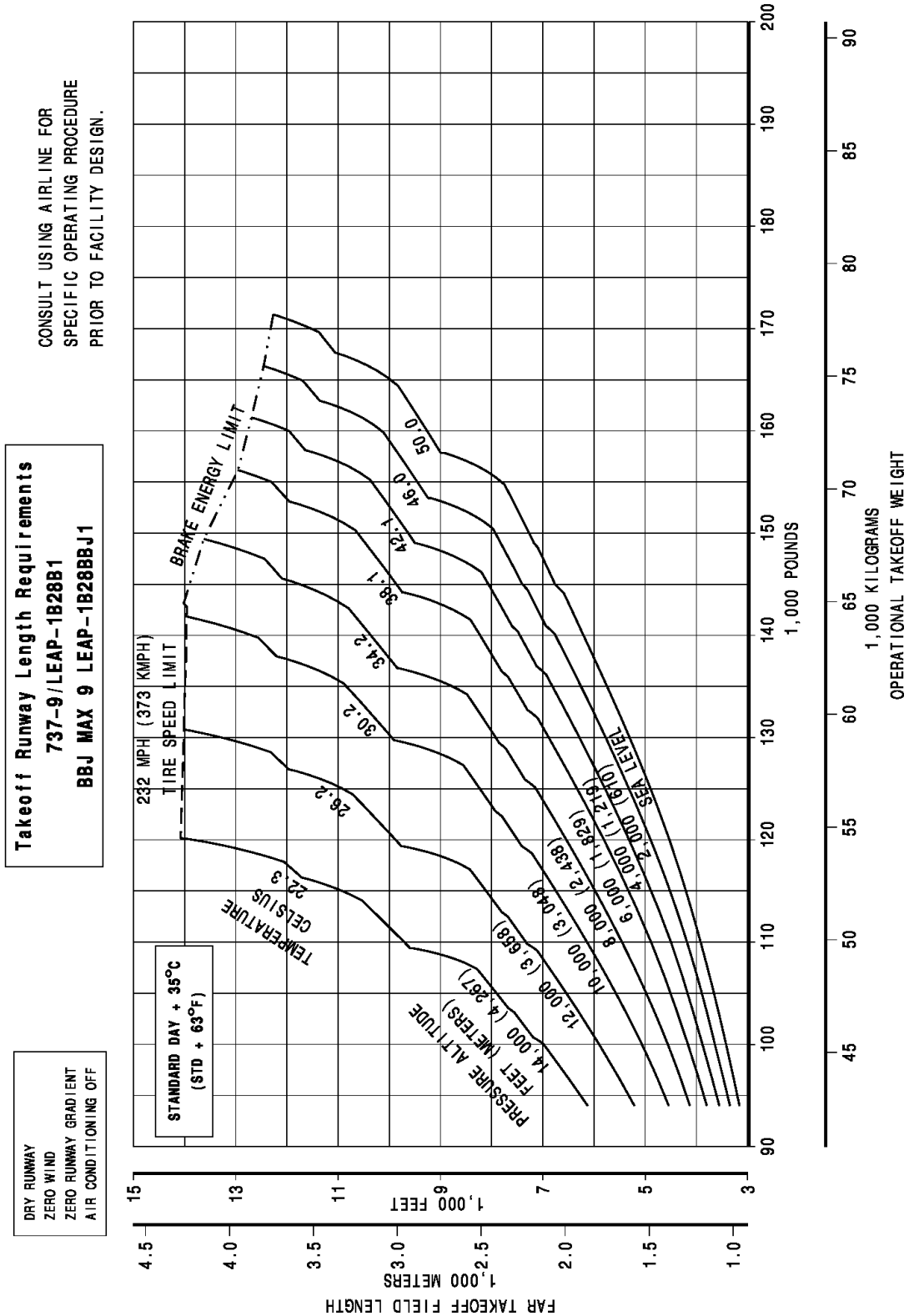

3.3.25 FAA/EASA Takeoff Runway Length Requirements: Model 737-10

DATA TO BE PROVIDED
AT A LATER DATE

3.3.26 ICAO Aerodrome Reference Code – All Models

The airplane is certified to operate up to its maximum takeoff weight (MTOW). The airplane flight manual provides field length requirements up to MTOW. The airplane reference code can vary for some models based on the airplane takeoff weight up to MTOW.

The following table shows the ICAO Aerodrome Reference Code classification for all models

AIRPLANE MODEL	TAKEOFF WEIGHT LB (KG)	AERODROME REFERENCE CODE
737-7	166,800 (75,659)	3C
737-7	177,000 (80,285)	4C
737-8	171,000 (77,564)	3C
737-8	182,200 (82,644)	4C
737-9	166,300 (75,433)	3C
737-9	194,700 (88,314)	4C

The reference takeoff weights are given for information only and not intended for dispatch purposes. Consult airline for specific operating procedures prior to facility design.

3.4 FAA/EASA LANDING RUNWAY LENGTH REQUIREMENTS

3.4.1 FAA/EASA Landing Runway Length Requirements - Flaps 15: Model 737-7 / BBJ MAX 7

Landing Field Length
737-7 and BBJ MAX 7
LEAP-1B Series engines

- STANDARD DAY, ZERO WIND
- AUTO SPOILERS OPERATIVE
- ANTI-SKID OPERATIVE
- ZERO RUNWAY GRADIENT
- CONSULT USING AIRLINE FOR SPECIFIC OPERATING PROCEDURE PRIOR TO FACILITY DESIGN

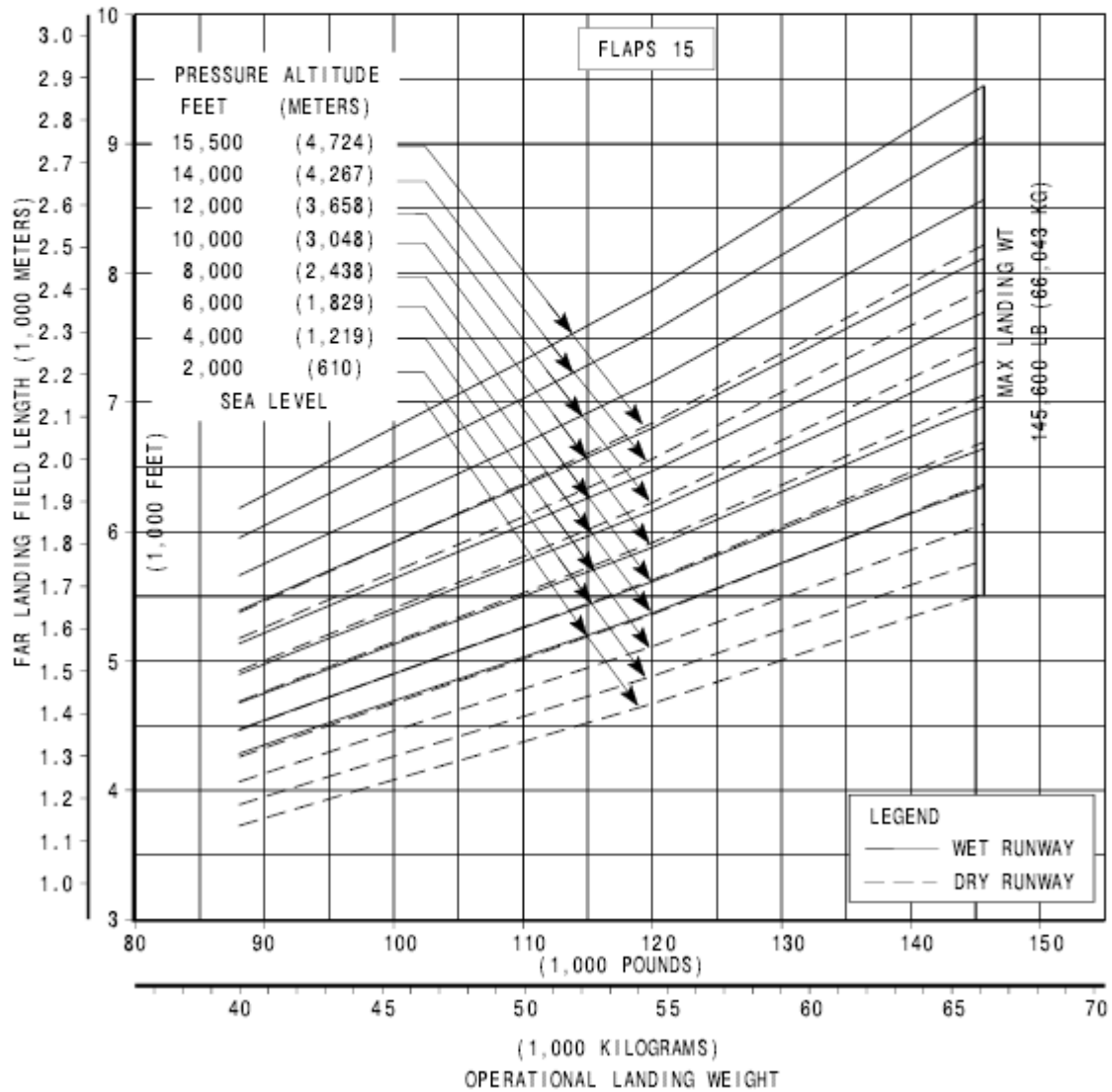

3.4.2 FAA/EASA Landing Runway Length Requirements - Flaps 30: Model 737-7 / BBJ MAX 7

Landing Field Length
737-7 and BBJ MAX 7
LEAP-1B Series Engines

- STANDARD DAY, ZERO WIND
- AUTO SPOILERS OPERATIVE
- ANTI-SKID OPERATIVE
- ZERO RUNWAY GRADIENT
- CONSULT USING AIRLINE FOR SPECIFIC OPERATING PROCEDURE PRIOR TO FACILITY DESIGN

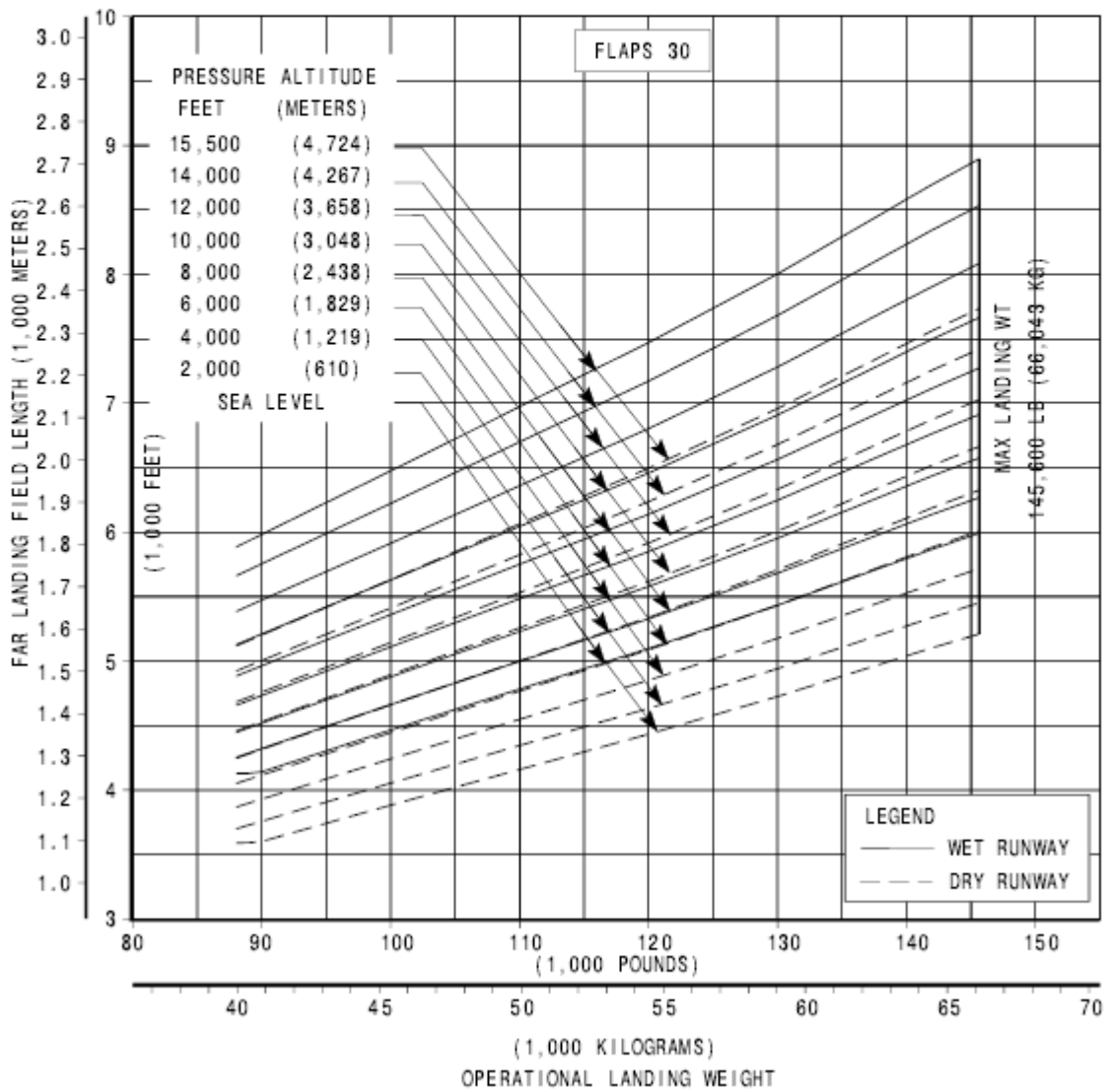

3.4.3 FAA/EASA Landing Runway Length Requirements - Flaps 40: Model 737-7 / BBJ MAX 7

**Landing Field Length
 737-7 and BBJ MAX 7
 LEAP-1B Series Engines**

- STANDARD DAY, ZERO WIND
- AUTO SPOILERS OPERATIVE
- ANTI-SKID OPERATIVE
- ZERO RUNWAY GRADIENT
- CONSULT USING AIRLINE FOR SPECIFIC OPERATING PROCEDURE PRIOR TO FACILITY DESIGN

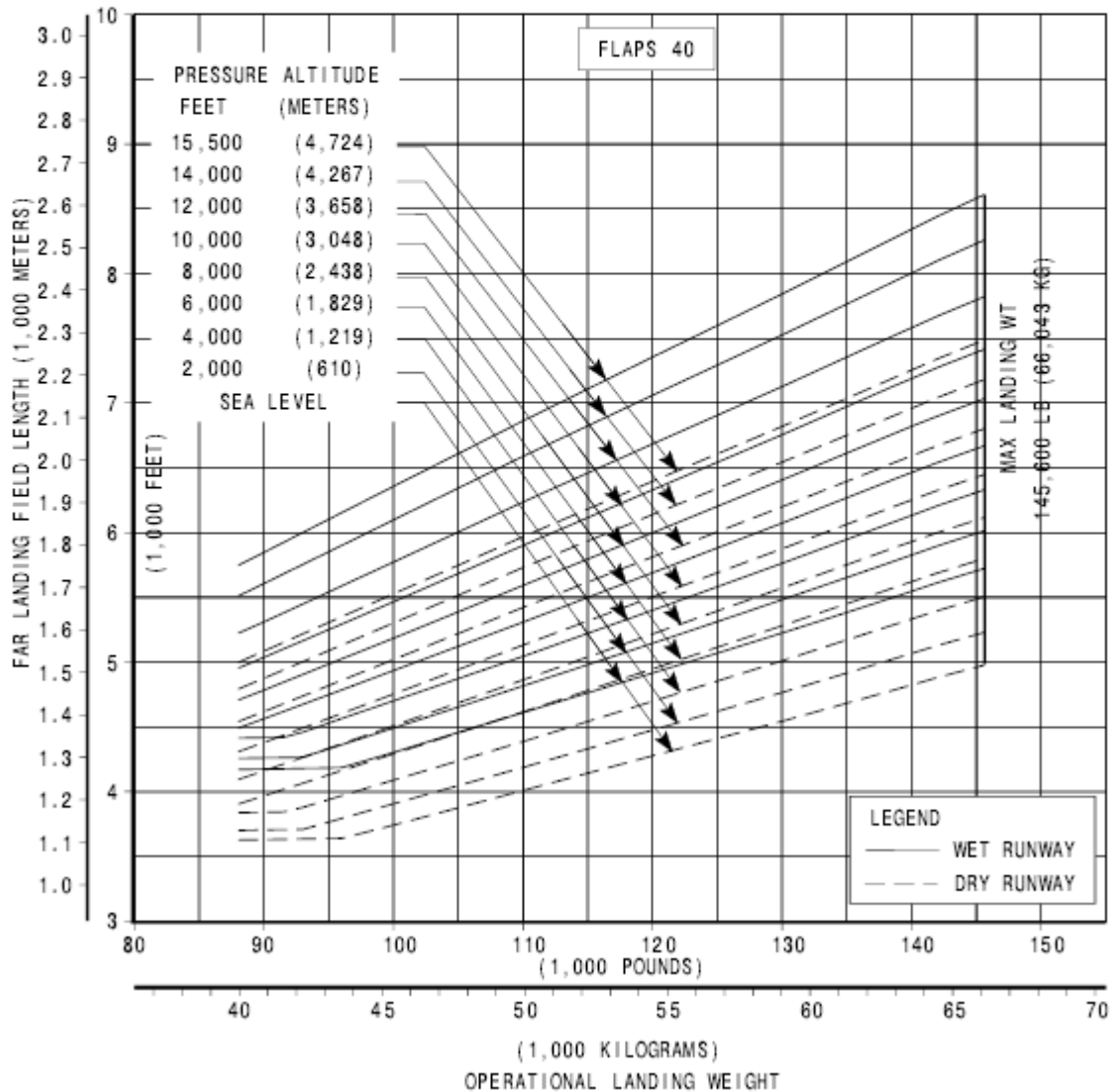

3.4.4 FAA/EASA Landing Runway Length Requirements - Flaps 15: Model 737-8 / -8-200 / BBJ MAX 8

**Landing Field Length
737-8 / -8-200 and BBJ MAX 8
LEAP-1B Series**

- STANDARD DAY, ZERO WIND
- AUTO SPOILERS OPERATIVE
- ANTI-SKID OPERATIVE
- ZERO RUNWAY GRADIENT
- CONSULT USING AIRLINE FOR SPECIFIC OPERATING PROCEDURE PRIOR TO FACILITY DESIGN

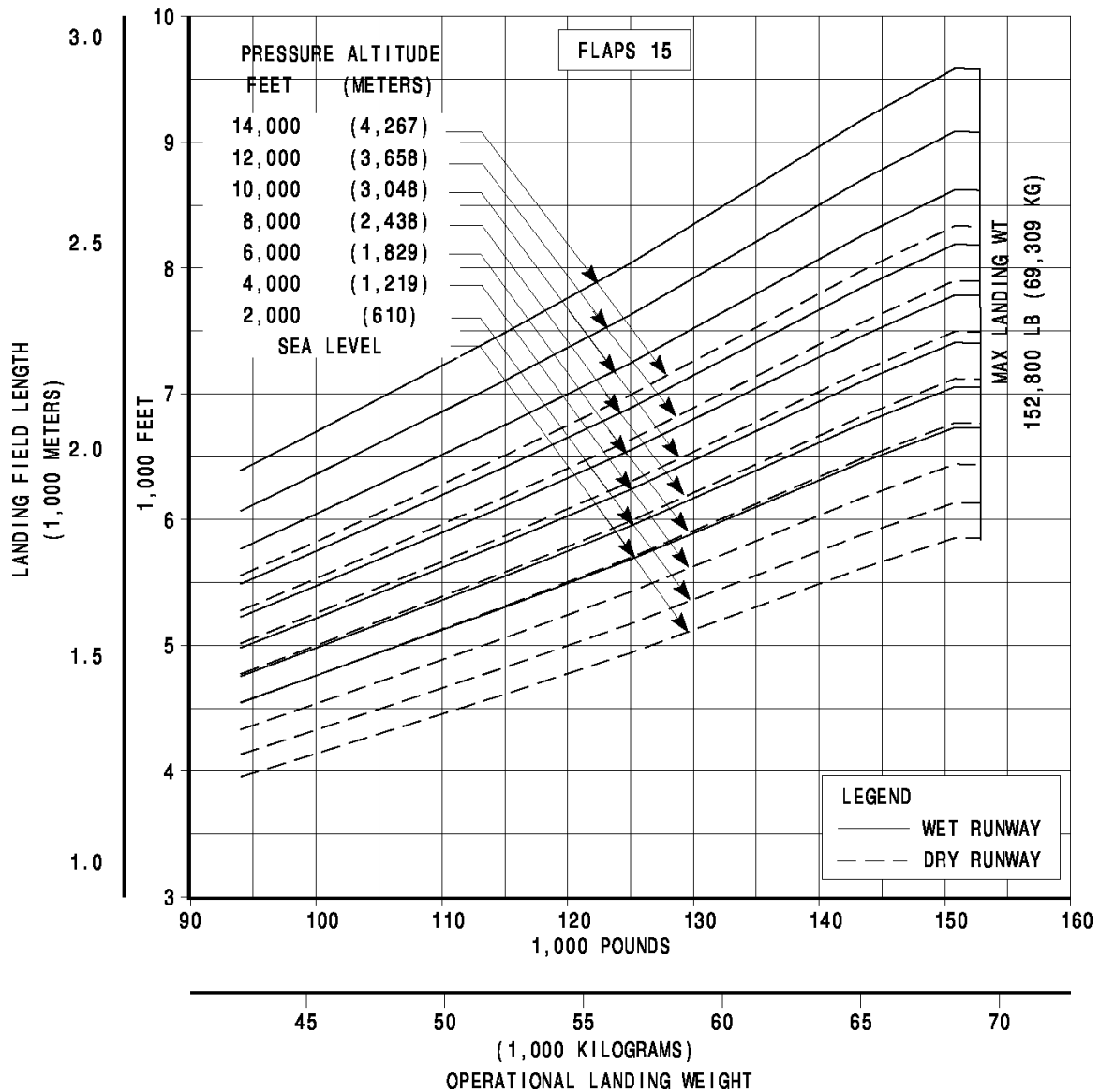

D6-38A004

3.4.5 FAA/EASA Landing Runway Length Requirements - Flaps 30: Model 737-8 / -8-200 / BBJ MAX 8

**Landing Field Length
737-8 / -8-200 and BBJ MAX 8
LEAP-1B Series**

- STANDARD DAY, ZERO WIND
- AUTO SPOILERS OPERATIVE
- ANTI-SKID OPERATIVE
- ZERO RUNWAY GRADIENT
- CONSULT USING AIRLINE FOR SPECIFIC OPERATING PROCEDURE PRIOR TO FACILITY DESIGN

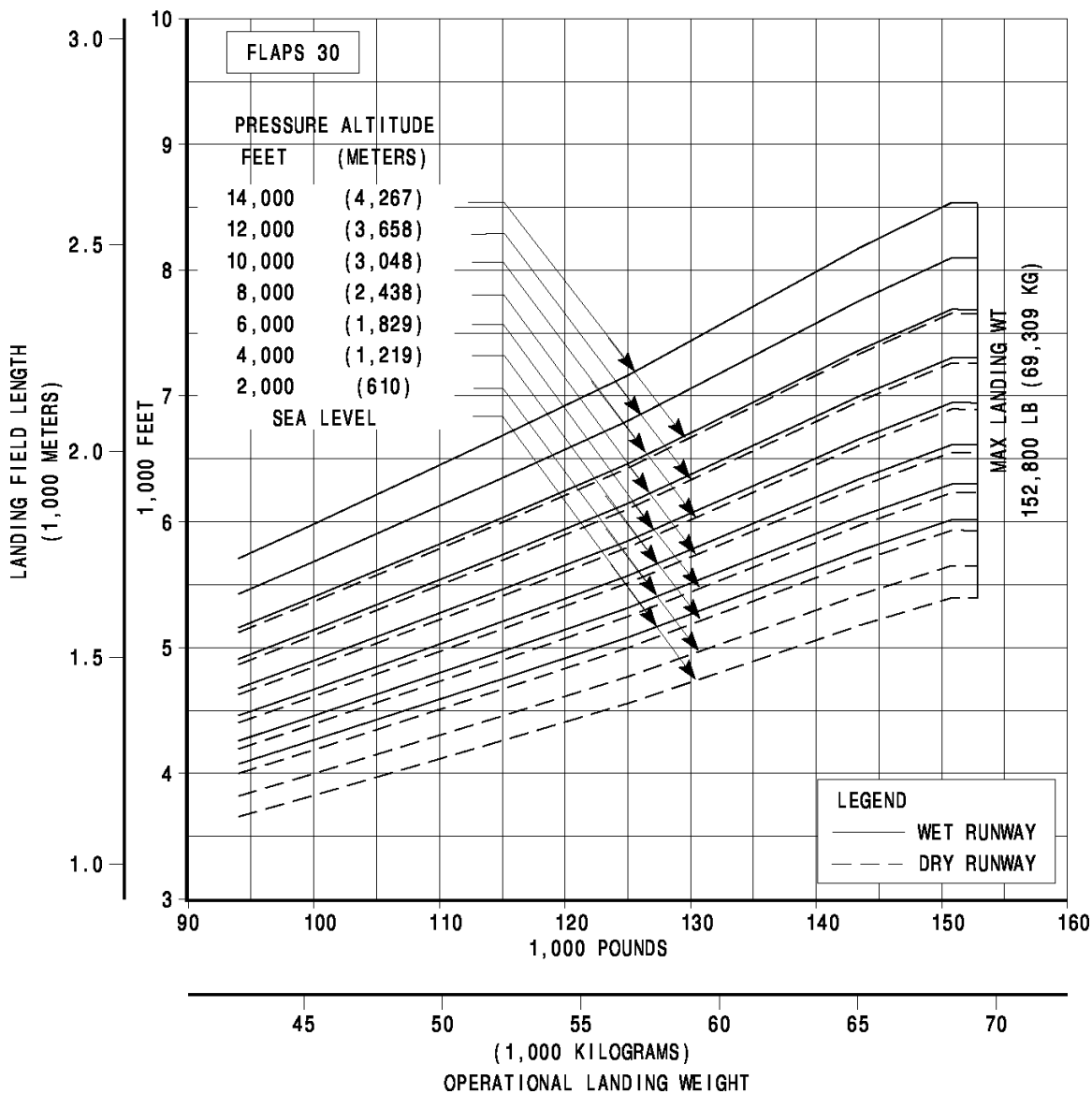

3.4.6 FAA/EASA Landing Runway Length Requirements - Flaps 40: Model 737-8 / -8-200 / BBJ MAX 8

Landing Field Length
737-8 / -8-200 and BBJ MAX 8
LEAP-1B Series

- STANDARD DAY, ZERO WIND
- AUTO SPOILERS OPERATIVE
- ANTI-SKID OPERATIVE
- ZERO RUNWAY GRADIENT
- CONSULT USING AIRLINE FOR SPECIFIC OPERATING PROCEDURE PRIOR TO FACILITY DESIGN

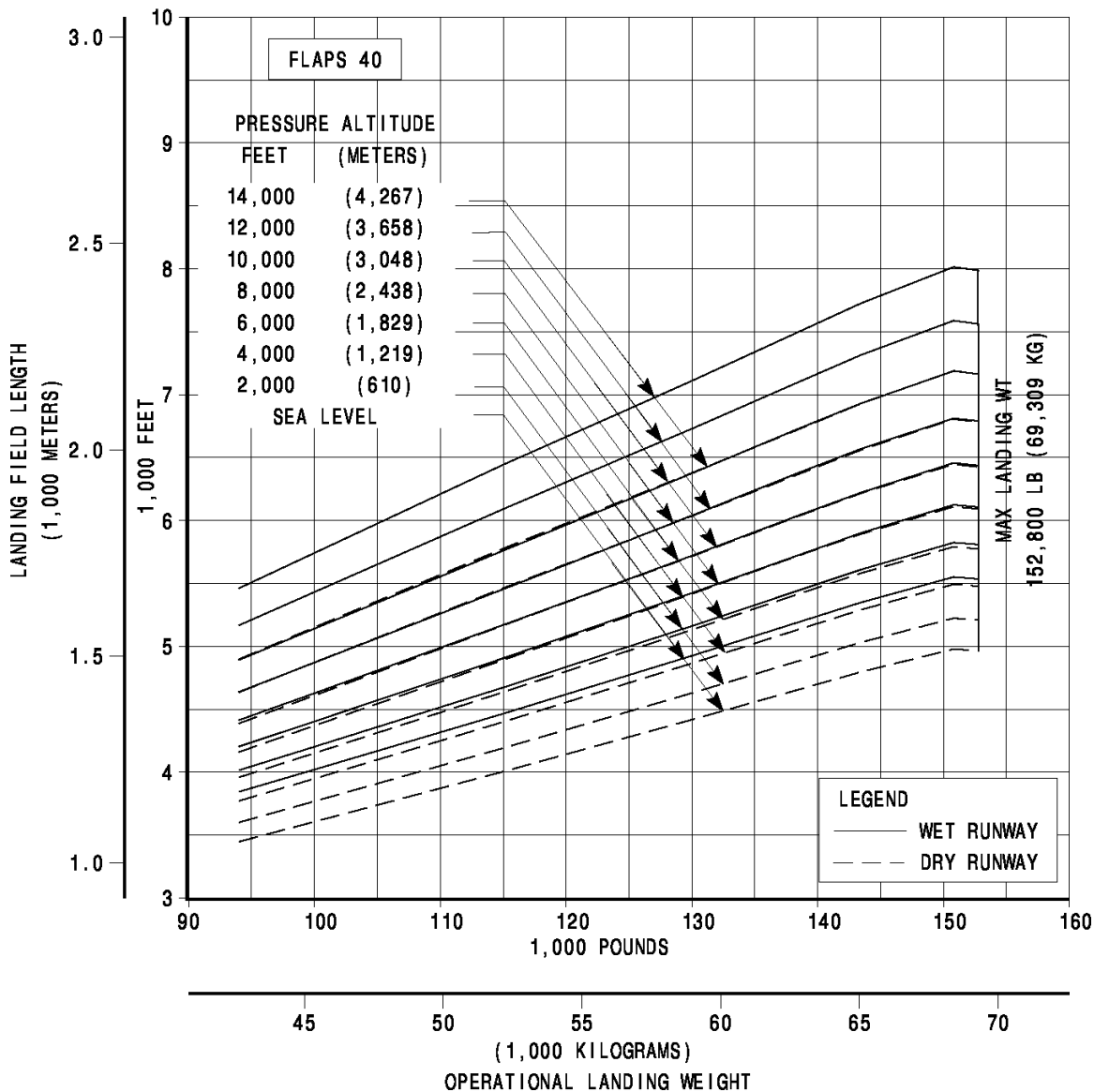

3.4.7 FAA/EASA Landing Runway Length Requirements - Flaps 15: Model 737-9 / BBJ MAX 9

Landing Field Length
737-9 and BBJ MAX 9
LEAP-1B Series Engines

- STANDARD DAY, ZERO WIND
- AUTO SPOILERS OPERATIVE
- ANTI-SKID OPERATIVE
- ZERO RUNWAY GRADIENT
- CONSULT USING AIRLINE FOR SPECIFIC OPERATING PROCEDURE PRIOR TO FACILITY DESIGN

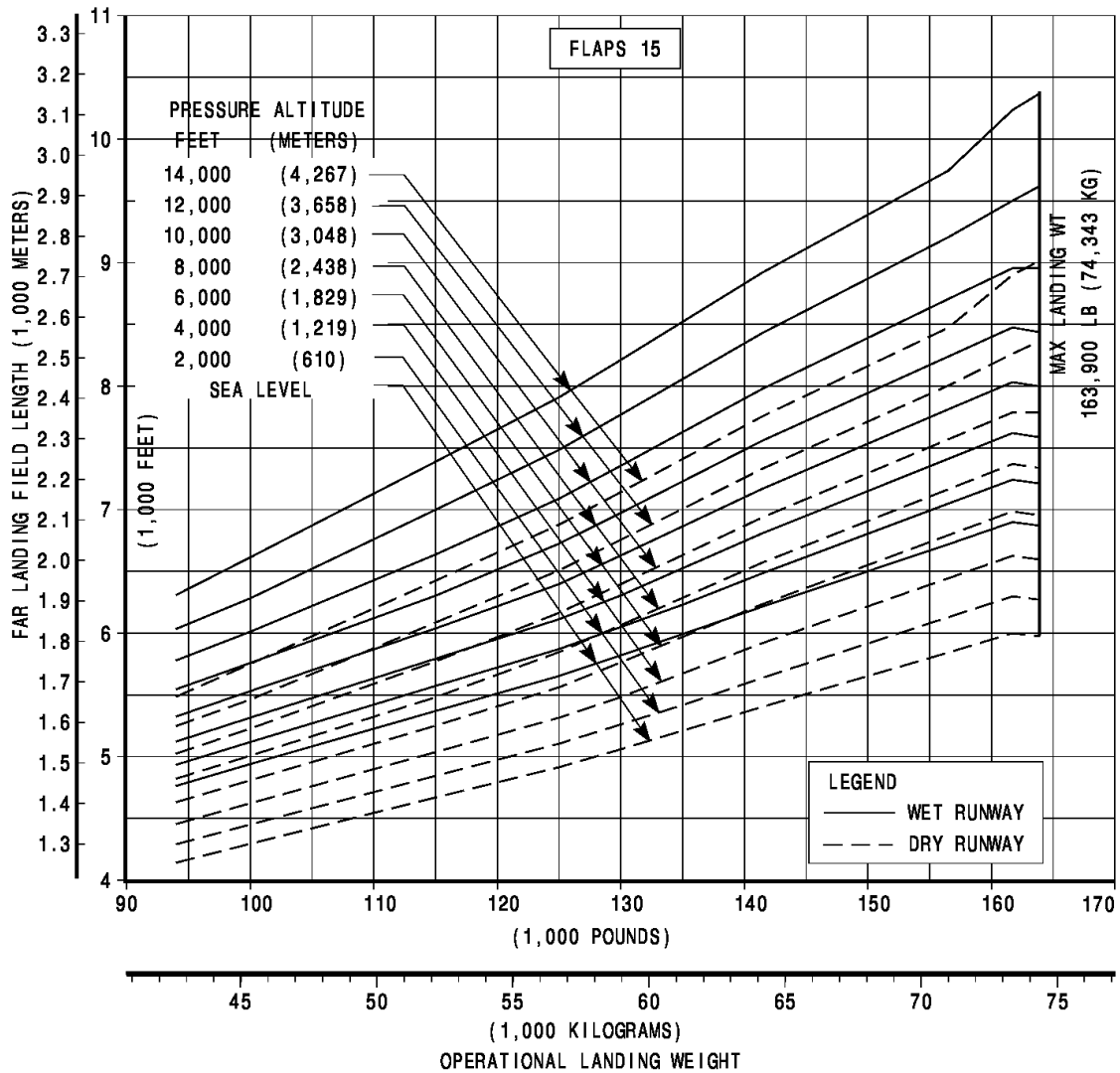

3.4.8 FAA/EASA Landing Runway Length Requirements - Flaps 30: Model 737-9 / BBJ MAX 9

Landing Field Length
737-9 and BBJ MAX 9
LEAP-1B Series Engines

- STANDARD DAY, ZERO WIND
- AUTO SPOILERS OPERATIVE
- ANTI-SKID OPERATIVE
- ZERO RUNWAY GRADIENT
- CONSULT USING AIRLINE FOR SPECIFIC OPERATING PROCEDURE PRIOR TO FACILITY DESIGN

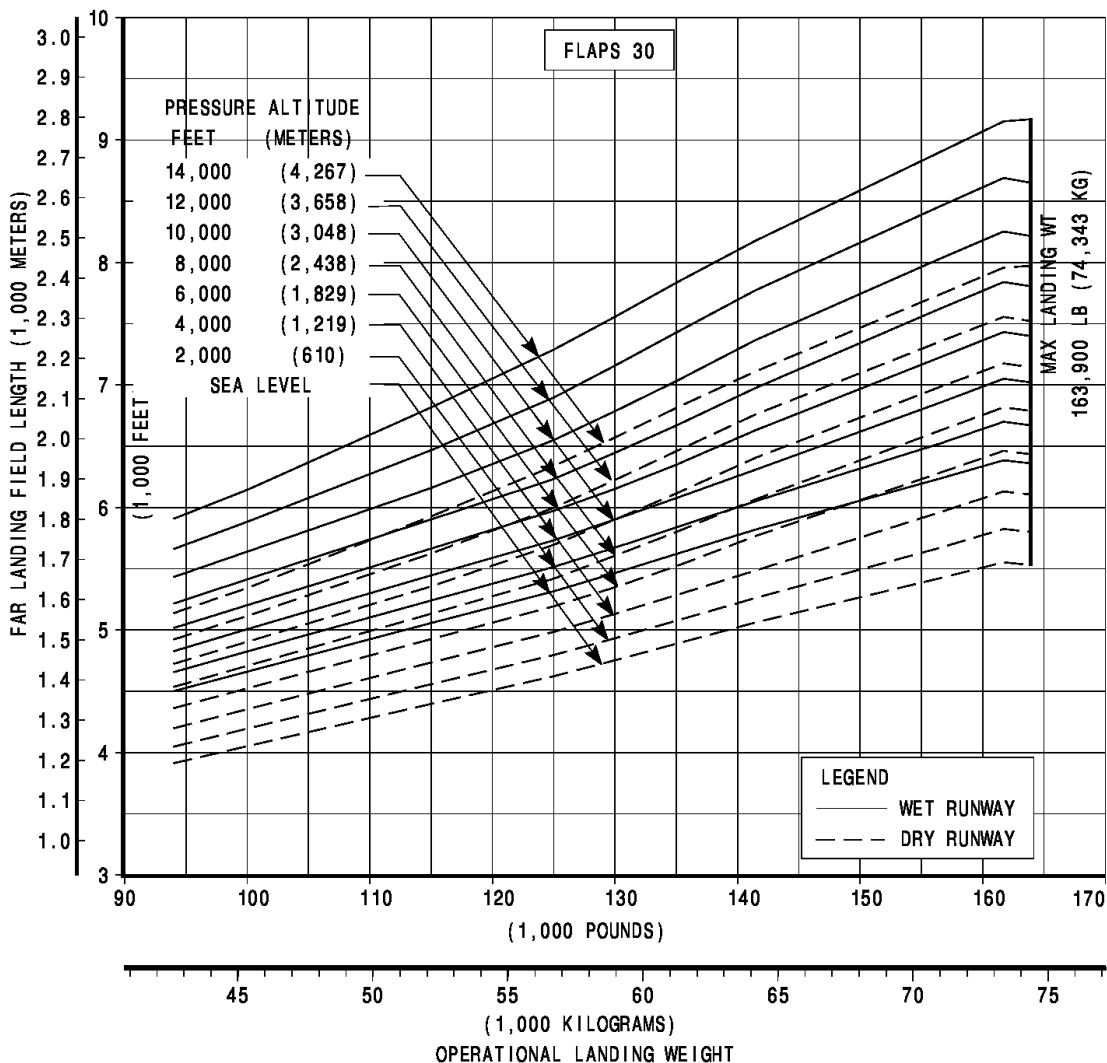

3.4.9 FAA/EASA Landing Runway Length Requirements - Flaps 40: Model 737-9 / BBJ MAX 9

**Landing Field Length
737-9 and BBJ MAX 9
LEAP-1B Series Engines**

- STANDARD DAY, ZERO WIND
- AUTO SPOILERS OPERATIVE
- ANTI-SKID OPERATIVE
- ZERO RUNWAY GRADIENT
- CONSULT USING AIRLINE FOR SPECIFIC OPERATING PROCEDURE PRIOR TO FACILITY DESIGN

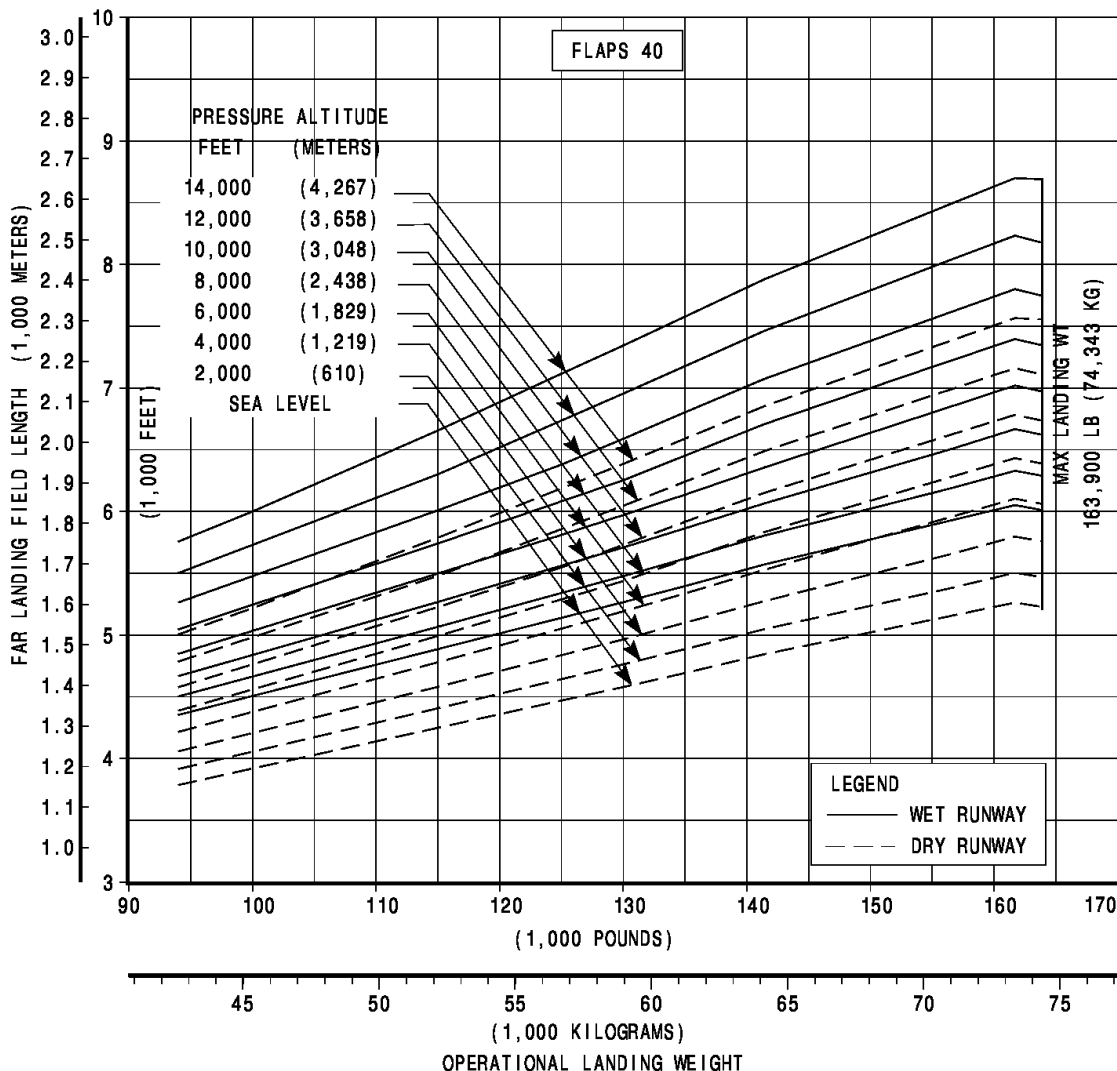

3.4.10 FAA/EASA Landing Runway Length Requirements: Model 737-10

DATA TO BE PROVIDED
AT A LATER DATE

4.0 GROUND MANEUVERING

4.1 GENERAL INFORMATION

This section provides airplane turning capability and maneuvering characteristics.

For ease of presentation, these data have been determined from the theoretical limits imposed by the geometry of the aircraft, and where noted, provide for a normal allowance for tire slippage. As such, they reflect the turning capability of the aircraft in favorable operating circumstances. These data should be used only as guidelines for the method of determination of such parameters and for the maneuvering characteristics of this aircraft.

In the ground operating mode, varying airline practices may demand that more conservative turning procedures be adopted to avoid excessive tire wear and reduce possible maintenance problems. Airline operating procedures will vary in the level of performance over a wide range of operating circumstances throughout the world. Variations from standard aircraft operating patterns may be necessary to satisfy physical constraints within the maneuvering area, such as adverse grades, limited area, or high risk of jet blast damage. For these reasons, ground maneuvering requirements should be coordinated with the using airlines prior to layout planning.

Section 4.2 presents turning radii for various nose gear steering angles. Radii for the main and nose gears are measured from the turn center to the outside of the tire.

Section 4.3 shows data on minimum width of pavement required for 180° turn.

Section 4.4 provides pilot visibility data from the cockpit and the limits of ambinoocular vision through the windows. Ambinoocular vision is defined as the total field of vision seen simultaneously by both eyes.

Section 4.5 shows approximate wheel paths for various runway and taxiway turn scenarios on a 100 ft (30 m) runway and 50 ft (15 m) taxiway system. Boeing 737 MAX aircraft are capable of operating on 100 ft wide runways. However, for design purposes, the FAA and ICAO recommend that the minimum runway width for the 737 MAX aircraft is 150 ft (45 m).

The pavement fillet geometries are based on the FAA's Advisory Circular (AC) 150/5300-13 (thru change 16). They represent typical fillet geometries built at many airports worldwide. ICAO and other civil aviation authorities publish many different fillet design methods. Prior to determining the size of fillets, airports are advised to check with the airlines regarding the operating procedures and aircraft types they expect to use at the airport. Further, given the cost of modifying fillets and the operational impact to ground movement and air traffic during construction, airports may want to design critical fillets for larger aircraft types to minimize future operational impacts.

Section 4.6 illustrates a typical runway holding bay configuration.

4.2 TURNING RADII

4.2.1 Turning Radii – No Slip Angle: Model 737-7

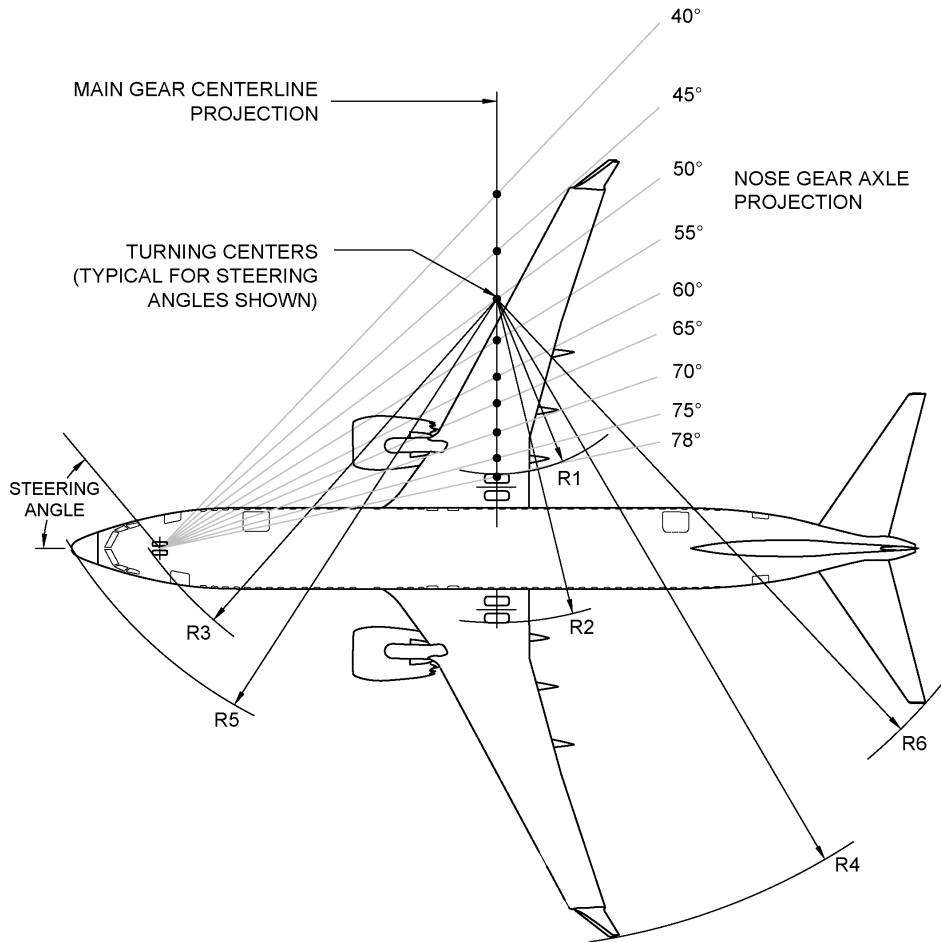

STEERING ANGLE (DEGREES)	R1		R2		R3		R4		R5		R6	
	INNER GEAR		OUTER GEAR		NOSE GEAR		WING TIP		NOSE		TAIL	
	FT	M	FT	M	FT	M	FT	M	FT	M	FT	M
30	65	19.8	88	26.8	89	27.1	137	41.8	96	29.3	116	35.4
35	52	15.8	75	22.9	78	23.8	123	37.5	85	25.9	105	32.0
40	41	12.5	64	19.5	70	21.3	113	34.4	78	23.8	97	29.6
45	33	10.1	56	17.1	63	19.2	105	32.0	73	22.3	90	27.4
50	26	7.9	49	14.9	59	18.0	98	29.9	69	21.0	85	25.9
55	20	6.1	43	13.1	55	16.8	92	28.0	65	19.8	81	24.7
60	14	4.3	37	11.3	52	15.8	87	26.5	63	19.2	77	23.5
65	9	2.7	32	9.8	50	15.2	82	25.0	61	18.6	74	22.6
70	5	1.5	28	8.5	48	14.6	78	23.8	60	18.3	72	21.9
75	1	0.3	24	7.3	47	14.3	74	22.6	59	18.0	70	21.3
78 (MAX)	-3	-0.9	21	6.4	46	14.0	71	21.6	59	18.0	68	20.7

4.2.2 Turning Radii – No Slip Angle: Model 737-8 / -8-200 / BBJ MAX 8

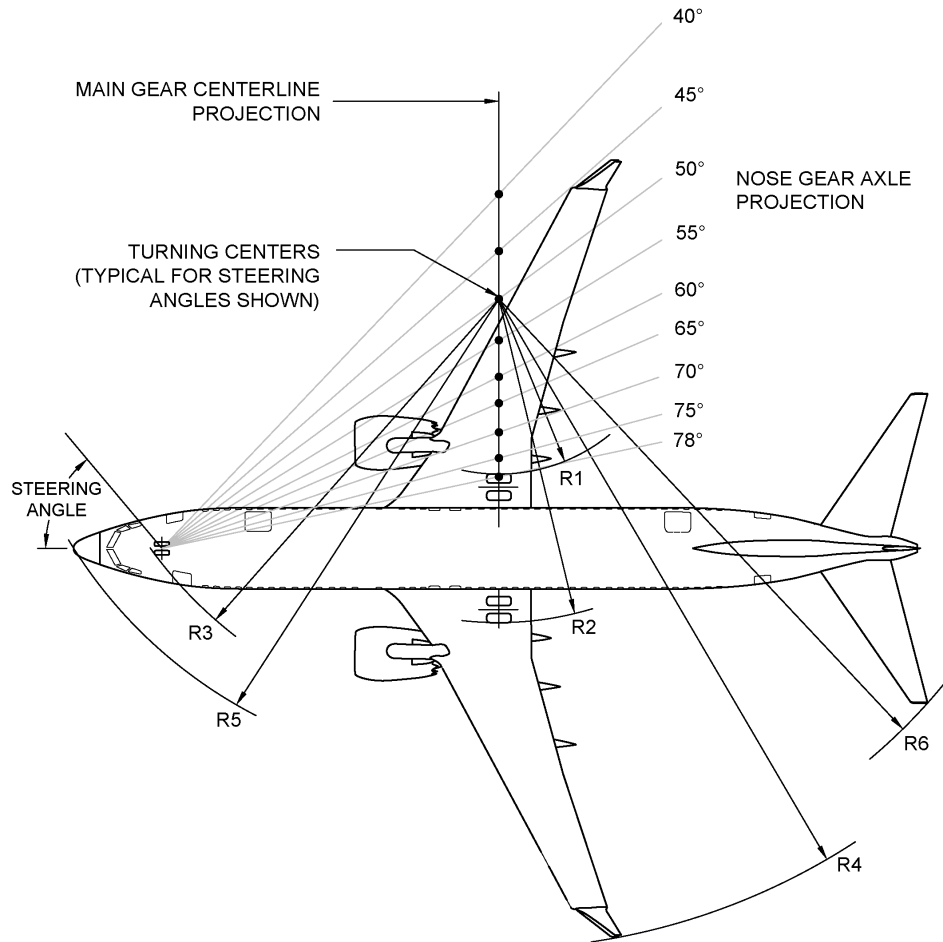

STEERING ANGLE (DEGREES)	R1		R2		R3		R4		R5		R6	
	INNER GEAR		OUTER GEAR		NOSE GEAR		WING TIP		NOSE		TAIL	
	FT	M	FT	M	FT	M	FT	M	FT	M	FT	M
30	78	23.8	101	30.8	104	31.7	149	45.4	110	33.5	130	39.6
35	62	18.9	85	25.9	91	27.7	134	40.8	98	29.9	117	35.7
40	50	15.2	73	22.3	81	24.7	122	37.2	89	27.1	107	32.6
45	40	12.2	63	19.2	74	22.6	112	34.1	83	25.3	99	30.2
50	32	9.8	55	16.8	68	20.7	104	31.7	78	23.8	93	28.3
55	25	7.6	48	14.6	64	19.5	97	29.6	74	22.6	88	26.8
60	19	5.8	42	12.8	61	18.6	91	27.7	72	21.9	84	25.6
65	13	4.0	36	11.0	58	17.7	85	25.9	69	21.0	81	24.7
70	8	2.4	31	9.4	56	17.1	80	24.4	68	20.7	78	23.8
75	3	0.9	26	7.9	54	16.5	75	22.9	67	20.4	75	22.9
78 (MAX)	-1	-0.3	23	7.0	54	16.5	73	22.3	66	20.1	74	22.6

4.2.3 Turning Radii – No Slip Angle: Model 737-9 / BBJ MAX 9

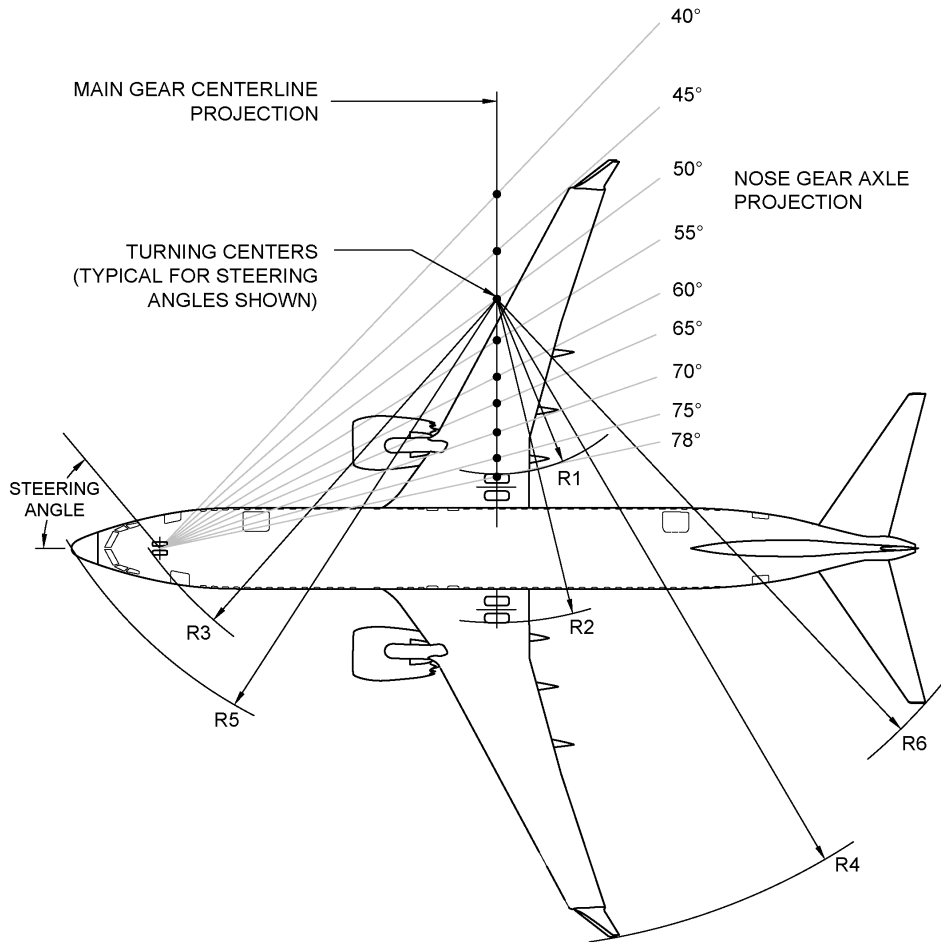

STEERING ANGLE (DEGREES)	R1		R2		R3		R4		R5		R6	
	INNER GEAR		OUTER GEAR		NOSE GEAR		WING TIP		NOSE		TAIL	
	FT	M	FT	M	FT	M	FT	M	FT	M	FT	M
30	87	26.5	110	33.5	114	34.7	158	48.2	120	36.6	140	42.7
35	69	21.0	92	28.0	100	30.5	141	43.0	107	32.6	125	38.1
40	56	17.1	79	24.1	89	27.1	128	39.0	97	29.6	114	34.7
45	45	13.7	68	20.7	81	24.7	117	35.7	90	27.4	106	32.3
50	36	11.0	59	18.0	75	22.9	108	32.9	85	25.9	99	30.2
55	28	8.5	51	15.5	70	21.3	101	30.8	81	24.7	93	28.3
60	22	6.7	45	13.7	67	20.4	94	28.7	77	23.5	89	27.1
65	15	4.6	38	11.6	64	19.5	88	26.8	75	22.9	85	25.9
70	10	3.0	32	9.8	61	18.6	82	25.0	73	22.3	82	25.0
75	4	1.2	27	8.2	60	18.3	77	23.5	72	21.9	79	24.1
78 (MAX)	1	0.3	24	7.3	59	18.0	74	22.6	71	21.6	78	23.8

4.2.4 Turning Radii – No Slip Angle: Model 737-10

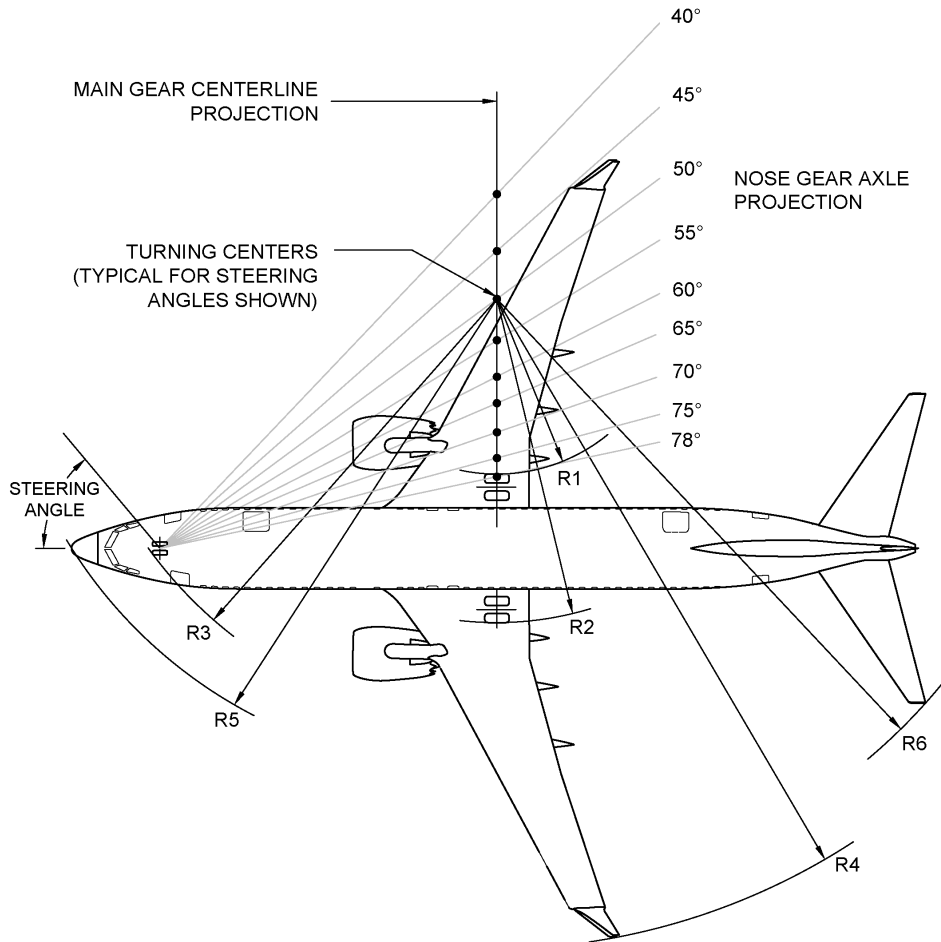

STEERING ANGLE (DEGREES)	R1		R2		R3		R4		R5		R6	
	INNER GEAR		OUTER GEAR		NOSE GEAR		WING TIP		NOSE		TAIL	
	FT	M	FT	M	FT	M	FT	M	FT	M	FT	M
30	93	28.3	116	35.4	122	37.2	164	50.0	128	39.0	146	44.5
35	75	22.9	98	29.9	106	32.3	146	44.5	113	34.4	130	39.6
40	61	18.6	84	25.6	95	29.0	132	40.2	103	31.4	119	36.3
45	49	14.9	72	21.9	86	26.2	121	36.9	95	29.0	110	33.5
50	39	11.9	62	18.9	80	24.4	111	33.8	90	27.4	102	31.1
55	31	9.4	54	16.5	75	22.9	103	31.4	85	25.9	97	29.6
60	24	7.3	47	14.3	71	21.6	96	29.3	82	25.0	92	28.0
65	17	5.2	40	12.2	68	20.7	89	27.1	79	24.1	88	26.8
70	11	3.4	34	10.4	65	19.8	83	25.3	77	23.5	84	25.6
75	5	1.5	28	8.5	64	19.5	78	23.8	76	23.2	81	24.7
78 (MAX)	2	0.6	25	7.6	63	19.2	74	22.6	75	22.9	80	24.4

4.3 CLEARANCE RADII

4.3.1 Clearance Radii – 3° and 5° Slip Angles: All Models

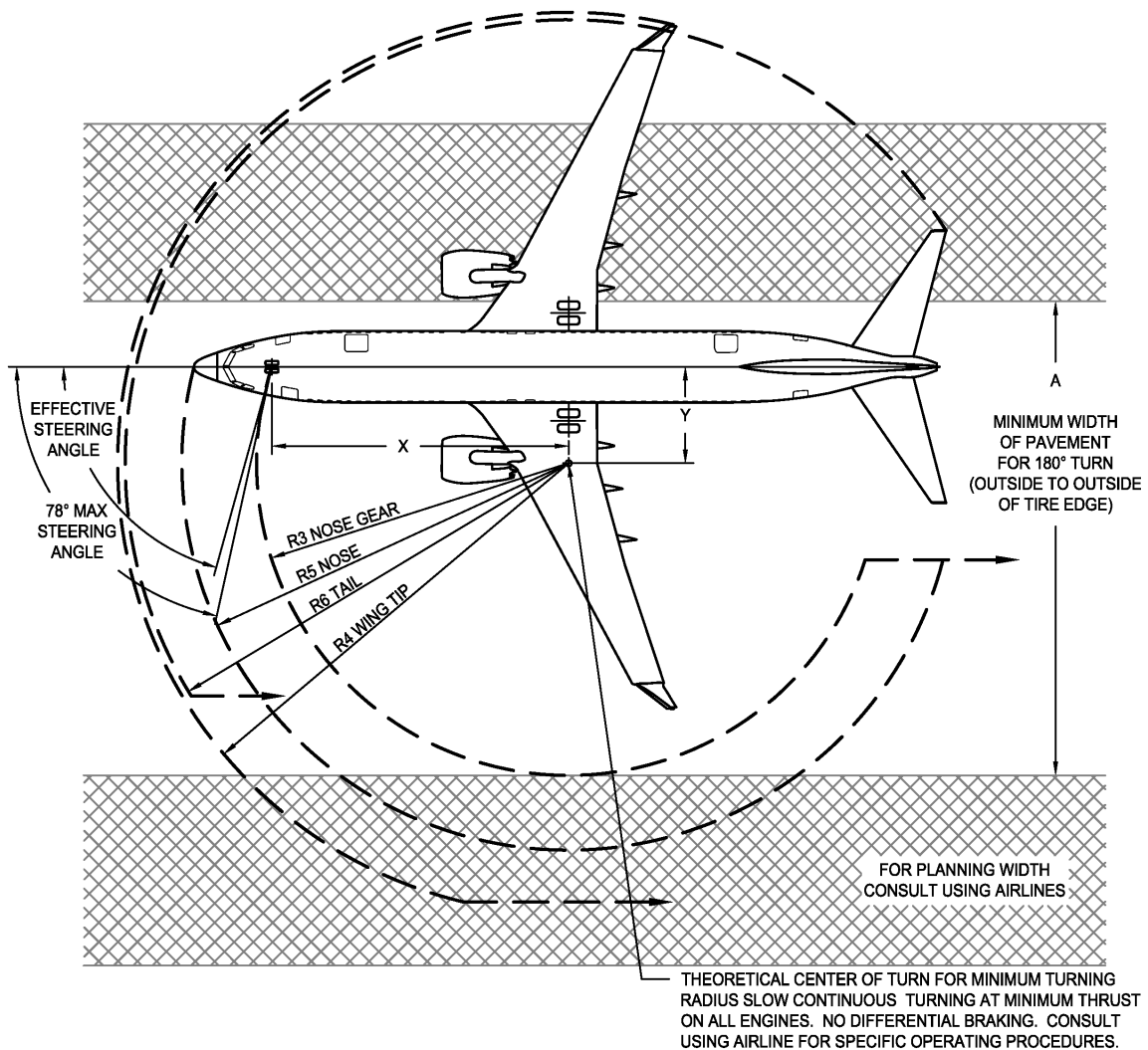

AIRPLANE MODEL	EFFECTIVE TURNING ANGLE (DEG)	X		Y		A		R3		R4		R5		R6	
		FT	M	FT	M	FT	M	FT	M	FT	M	FT	M	FT	M
737-7	75	44	13.4	12	3.7	70	21.3	47	14.3	74	22.6	59	18.0	70	21.3
	73	44	13.4	14	4.3	72	21.9	47	14.3	75	22.9	59	18.0	70	21.3
737-8 / -8-200 / BBJ MAX 8	75	52	15.8	14	4.3	80	24.4	54	16.5	75	22.9	67	20.4	75	22.9
	73	52	15.8	16	4.9	82	25.0	55	16.8	77	23.5	67	20.4	76	23.2
737-9 / BBJ MAX 9	75	57	17.4	16	4.9	86	26.2	60	18.3	76	23.2	72	21.9	79	24.1
	73	57	17.4	18	5.5	89	27.1	60	18.3	79	24.1	72	21.9	80	24.4
737-10	73	61	18.6	19	5.8	94	28.7	64	19.5	80	24.4	76	23.2	82	25.0

NOTES: 5° TIRE SLIP IS ESTIMATED TO BE THE MAXIMUM TIRE SLIP FOR THE EFFECTIVE STEERING ANGLE OF 73°. THE 3° TIRE SLIP DIMENSIONS ARE FOR COMPARISON PURPOSES.

4.4 VISIBILITY FROM COCKPIT IN STATIC POSITION: ALL MODELS

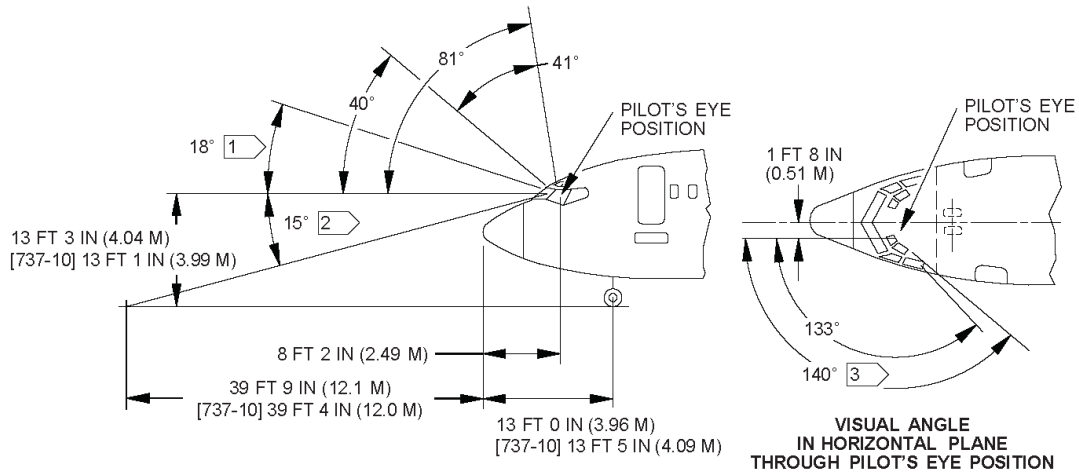

VISUAL ANGLES IN PLANE PARALLEL TO LONGITUDINAL AXIS THROUGH PILOT'S EYE POSITION

VISUAL ANGLE IN HORIZONTAL PLANE THROUGH PILOT'S EYE POSITION

NOT TO SCALE

NOT TO BE USED FOR LANDING APPROACH VISIBILITY

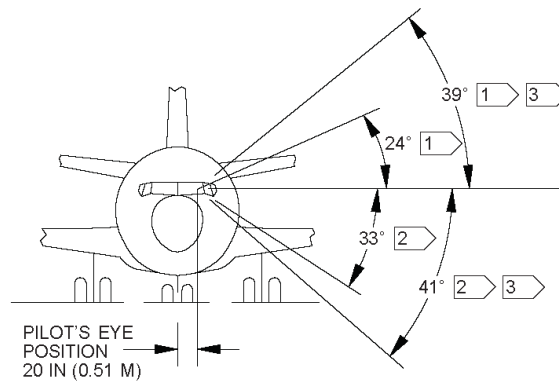

VISUAL ANGLES IN PLANE PERPENDICULAR TO LONGITUDINAL AXIS THROUGH PILOT'S EYE POSITION

NOTE:

HEAD ROTATED ABOUT POINT 3.3 IN. (0.08 M) AFT OF PILOT'S EYE POSITION

- 1 UPWARD VISION THROUGH MAIN WINDOW
- 2 DOWNWARD VISION THROUGH MAIN WINDOW
- 3 WITH HEAD MOVED 5 IN. (0.13 M) OUTBOARD

4.5 RUNWAY AND TAXIWAY TURNPATHS

4.5.1 Runway and Taxiway Turnpaths - Runway-to-Taxiway, More Than 90-Degree Turn: Model 737-7

NOTE: BEFORE DETERMINING THE SIZE OF A FILLET, CHECK WITH THE OPERATING AIRLINES REGARDING THE OPERATING PROCEDURES IN USE AND THE AIRCRAFT TYPES INTENDED TO SERVE THE AIRPORT.

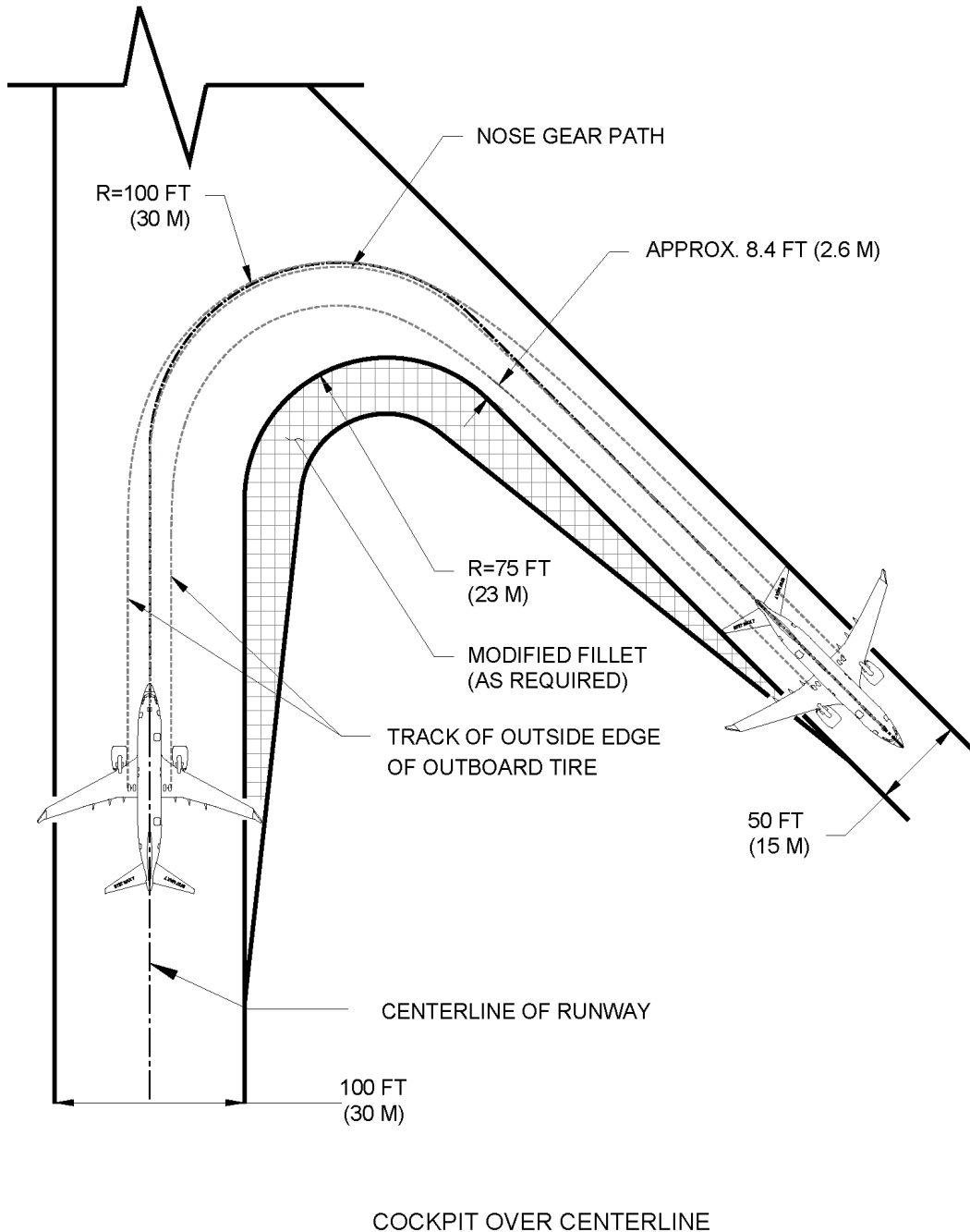

4.5.2 Runway and Taxiway Turnpaths - Runway-to-Taxiway, 90-Degree Turn: Model 737-7

NOTE: BEFORE DETERMINING THE SIZE OF A FILLET, CHECK WITH THE OPERATING AIRLINES REGARDING THE OPERATING PROCEDURES IN USE AND THE AIRCRAFT TYPES INTENDED TO SERVE THE AIRPORT.

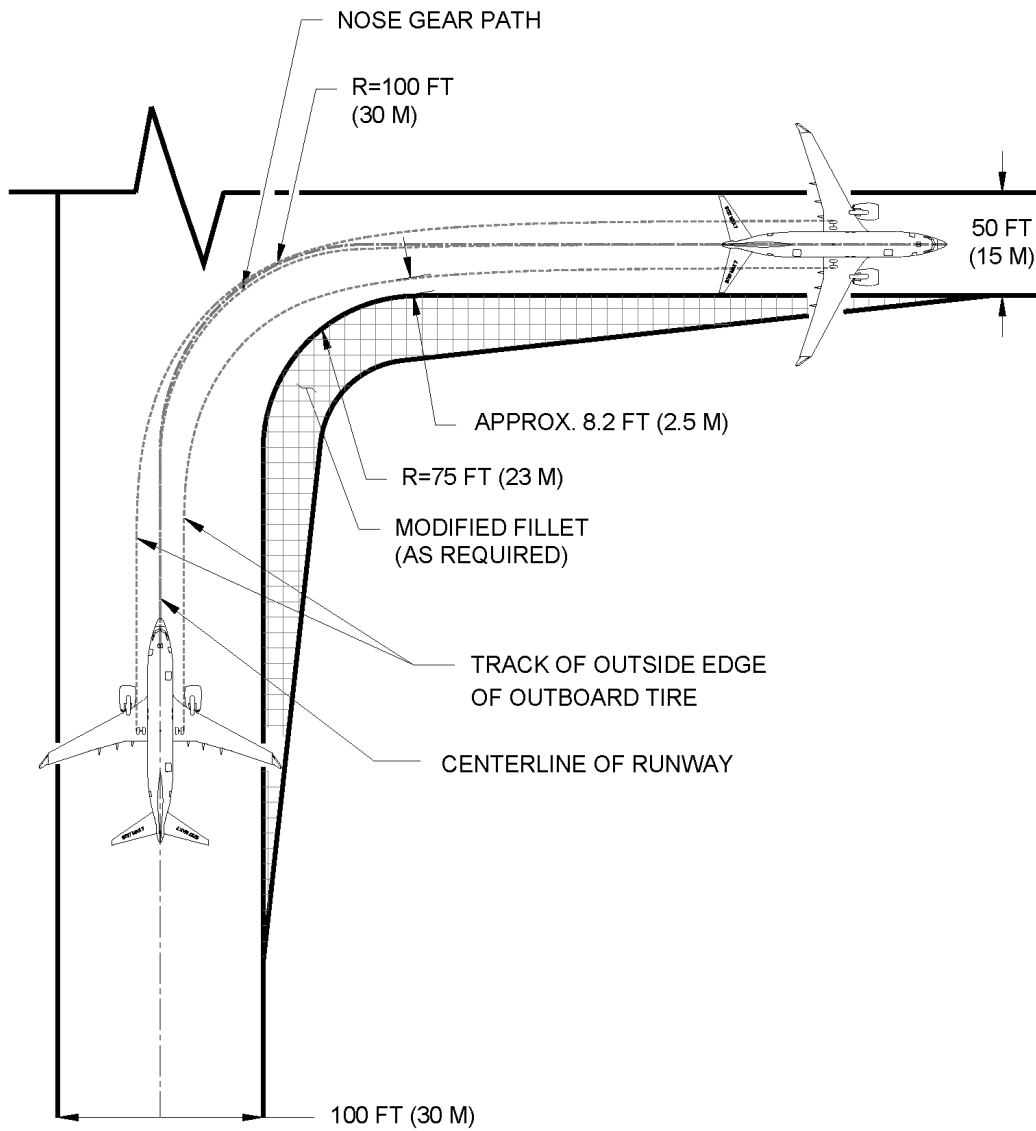

COCKPIT OVER CENTERLINE

4.5.3 Runway and Taxiway Turnpaths - Taxiway-to-Taxiway, 90-Degree Turn: Model 737-7

NOTE: BEFORE DETERMINING THE SIZE OF A FILLET, CHECK WITH THE OPERATING AIRLINES REGARDING THE OPERATING PROCEDURES IN USE AND THE AIRCRAFT TYPES INTENDED TO SERVE THE AIRPORT.

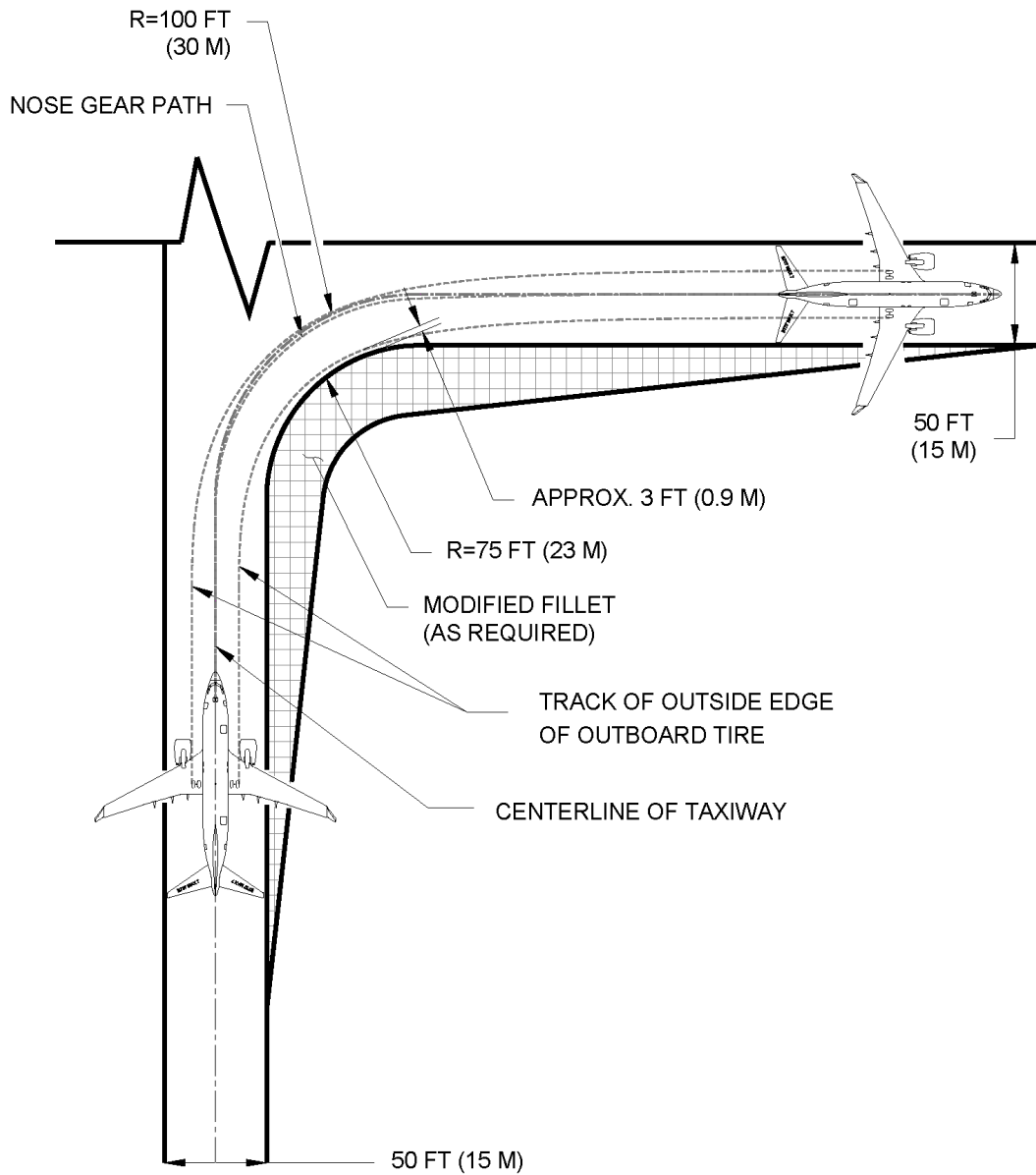

COCKPIT OVER CENTERLINE

4.5.4 Runway and Taxiway Turnpaths - Runway-to-Taxiway, More Than 90-Degree Turn: Model 737-8 / -8-200 / BBJ MAX 8

NOTE: BEFORE DETERMINING THE SIZE OF A FILLET, CHECK WITH THE OPERATING AIRLINES REGARDING THE OPERATING PROCEDURES IN USE AND THE AIRCRAFT TYPES INTENDED TO SERVE THE AIRPORT.

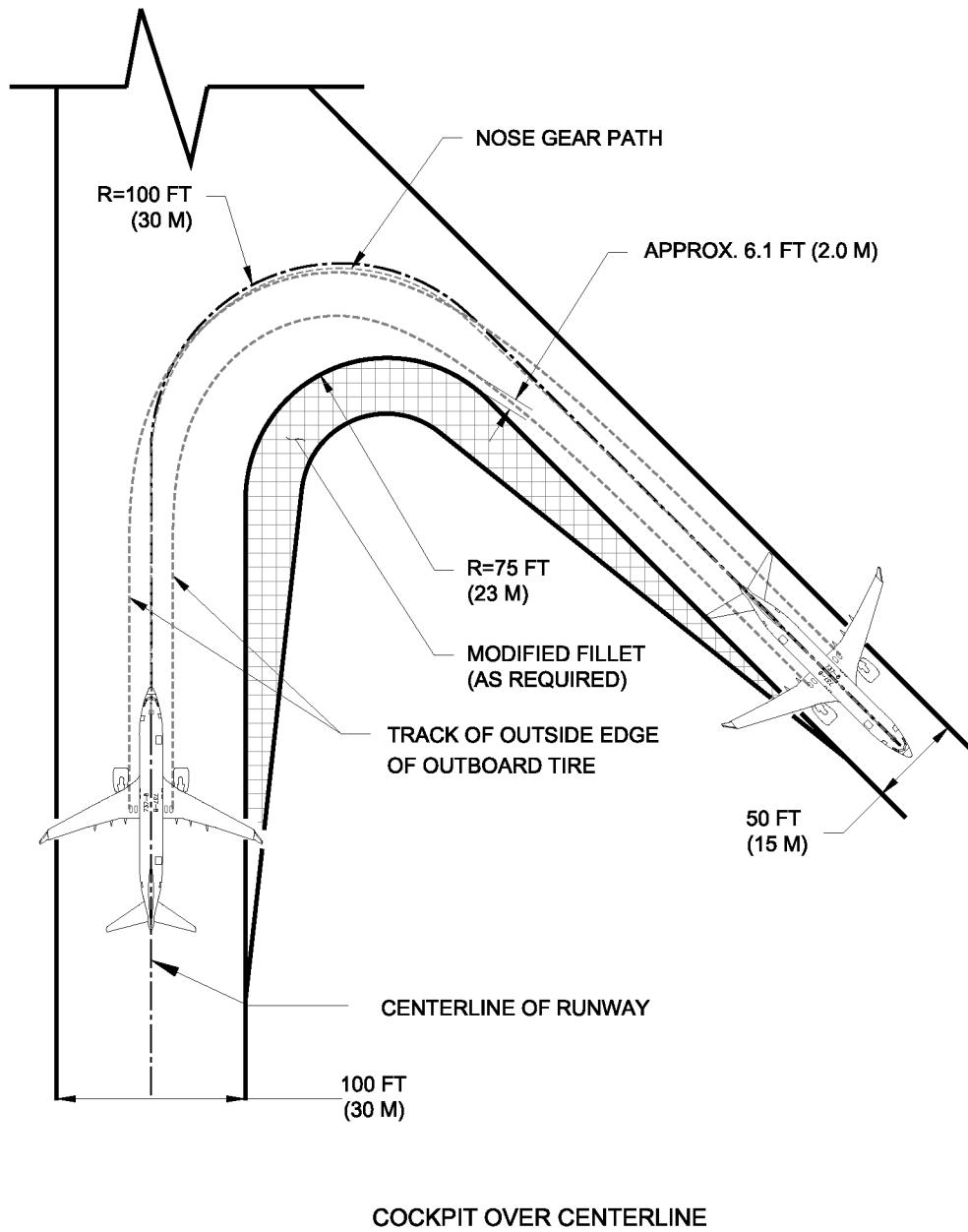

4.5.5 Runway and Taxiway Turnpaths - Runway-to-Taxiway, 90-Degree Turn: Model 737-8 / -8-200 / BBJ MAX 8

NOTE: BEFORE DETERMINING THE SIZE OF A FILLET, CHECK WITH THE OPERATING AIRLINES REGARDING THE OPERATING PROCEDURES IN USE AND THE AIRCRAFT TYPES INTENDED TO SERVE THE AIRPORT.

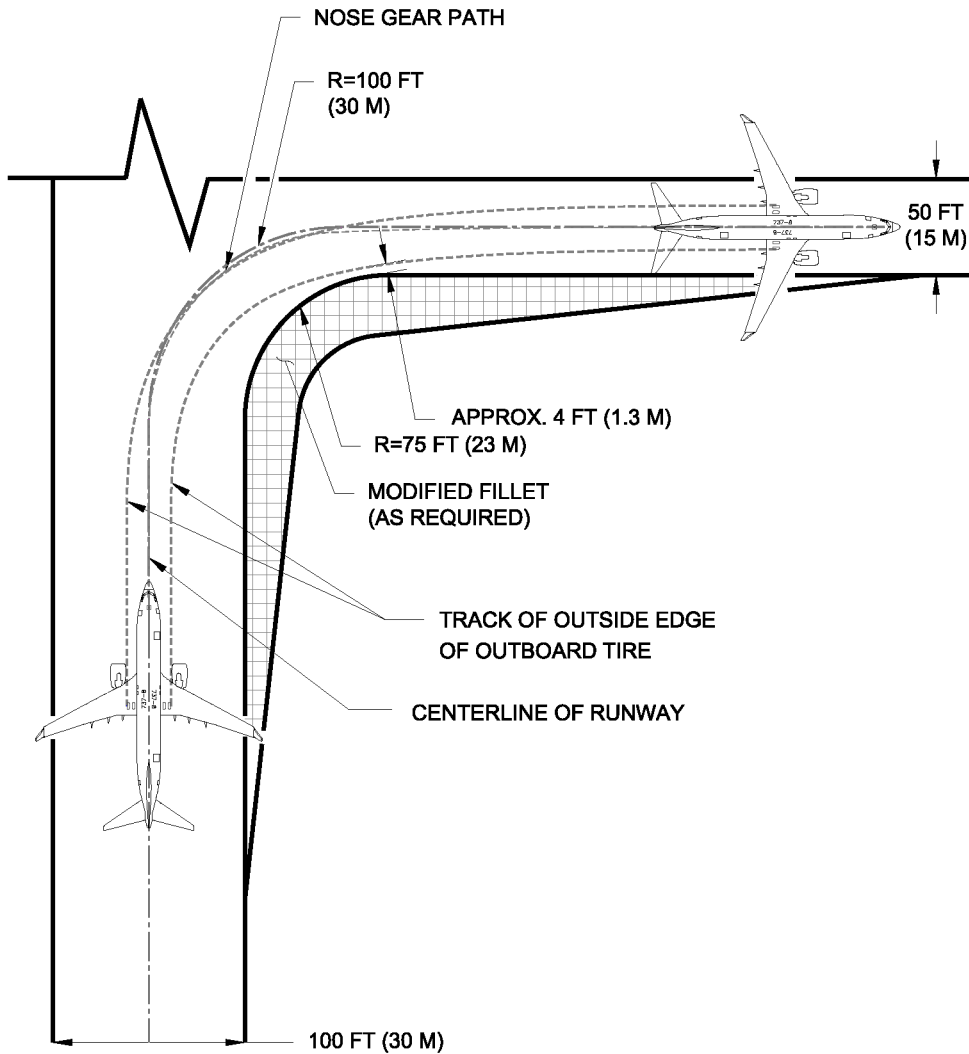

COCKPIT OVER CENTERLINE

4.5.6 Runway and Taxiway Turnpaths - Taxiway-to-Taxiway, 90-Degree Turn: Model 737-8 / -8-200 / BBJ MAX 8

NOTE: BEFORE DETERMINING THE SIZE OF A FILLET, CHECK WITH THE OPERATING AIRLINES REGARDING THE OPERATING PROCEDURES IN USE AND THE AIRCRAFT TYPES INTENDED TO SERVE THE AIRPORT.

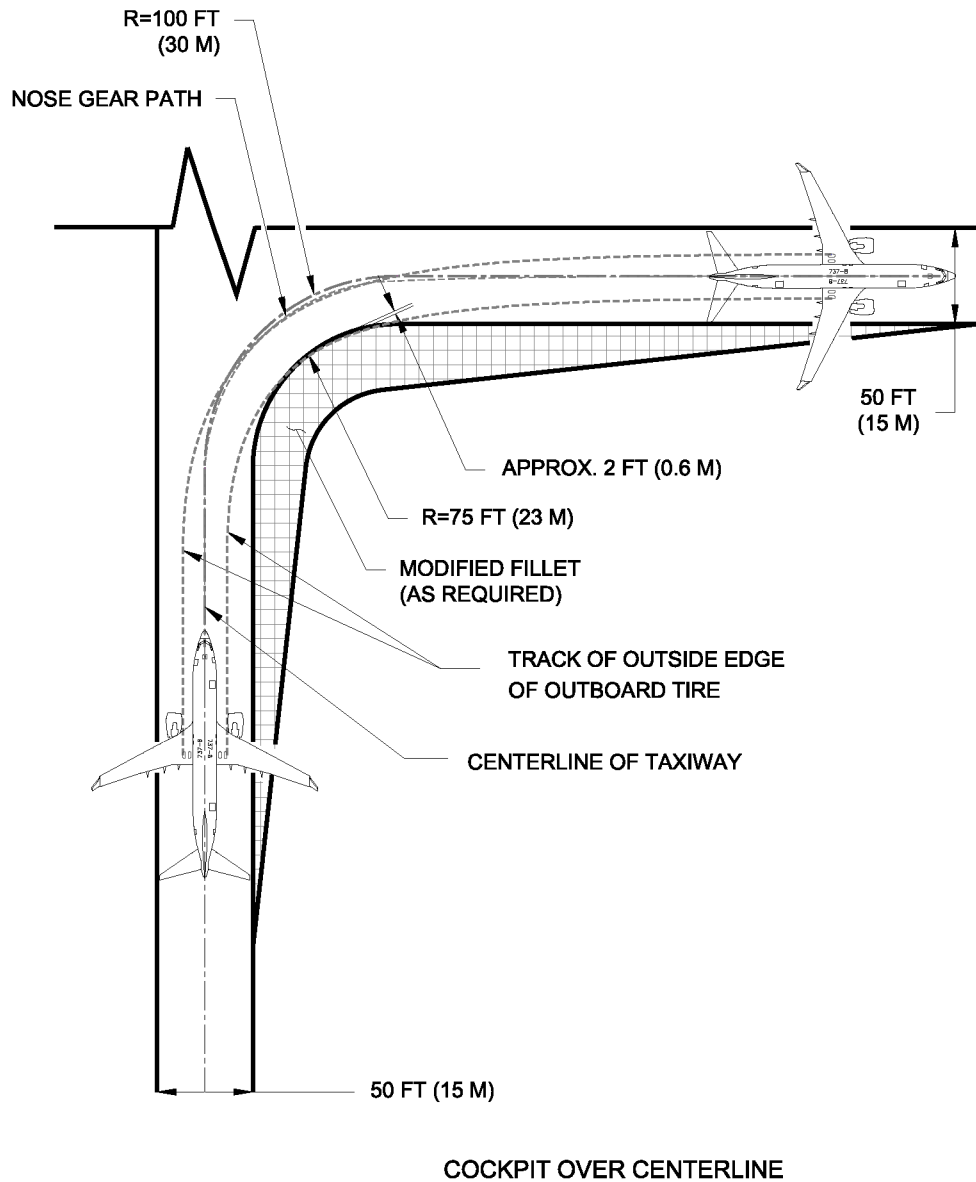

4.5.7 Runway and Taxiway Turnpaths - Runway-to-Taxiway, More Than 90-Degree Turn: Model 737-9 / BBJ MAX 9

NOTE: BEFORE DETERMINING THE SIZE OF A FILLET, CHECK WITH THE OPERATING AIRLINES REGARDING THE OPERATING PROCEDURES IN USE AND THE AIRCRAFT TYPES INTENDED TO SERVE THE AIRPORT.

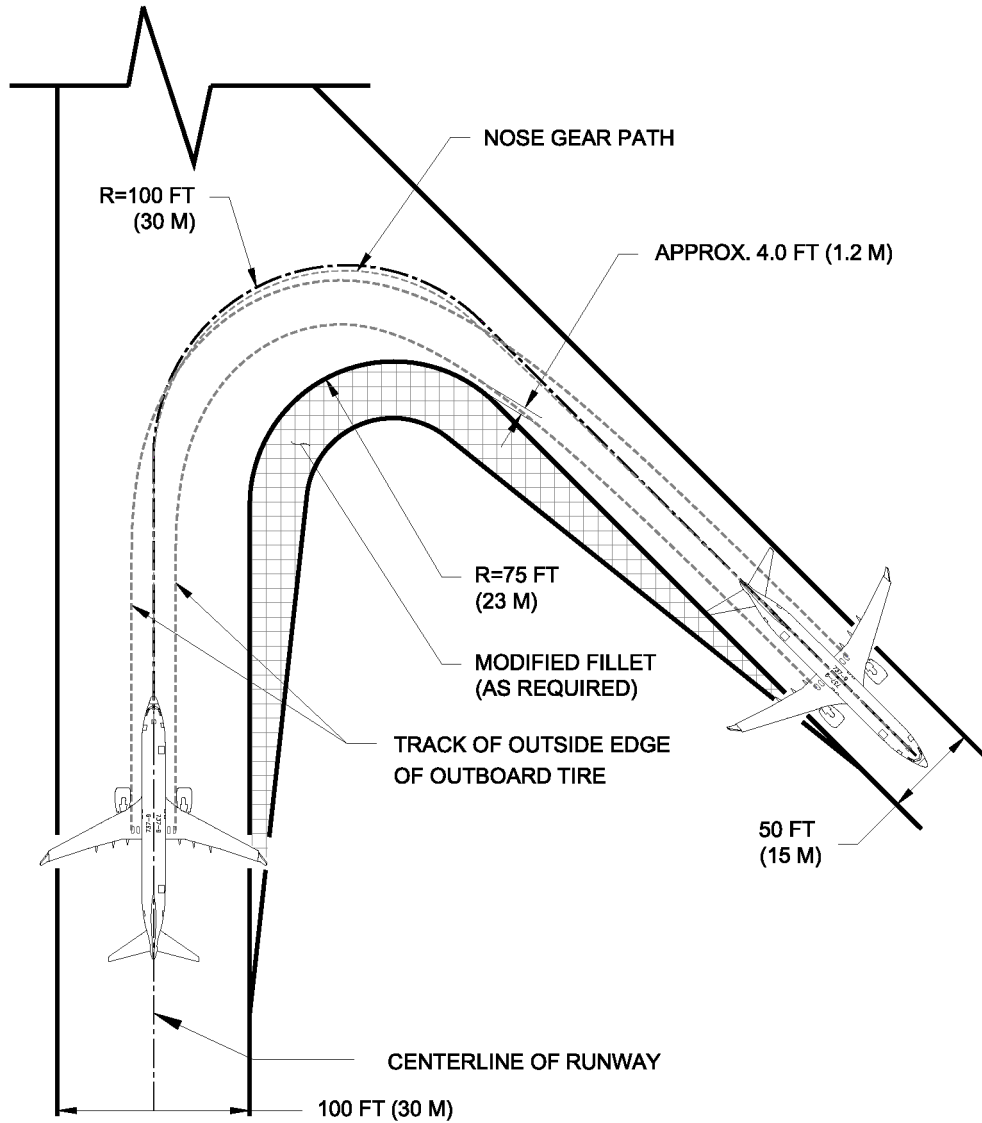

COCKPIT OVER CENTERLINE

4.5.8 Runway and Taxiway Turnpaths - Runway-to-Taxiway, 90-Degree Turn: Model 737-9 / BBJ MAX 9

NOTE: BEFORE DETERMINING THE SIZE OF A FILLET, CHECK WITH THE OPERATING AIRLINES REGARDING THE OPERATING PROCEDURES IN USE AND THE AIRCRAFT TYPES INTENDED TO SERVE THE AIRPORT.

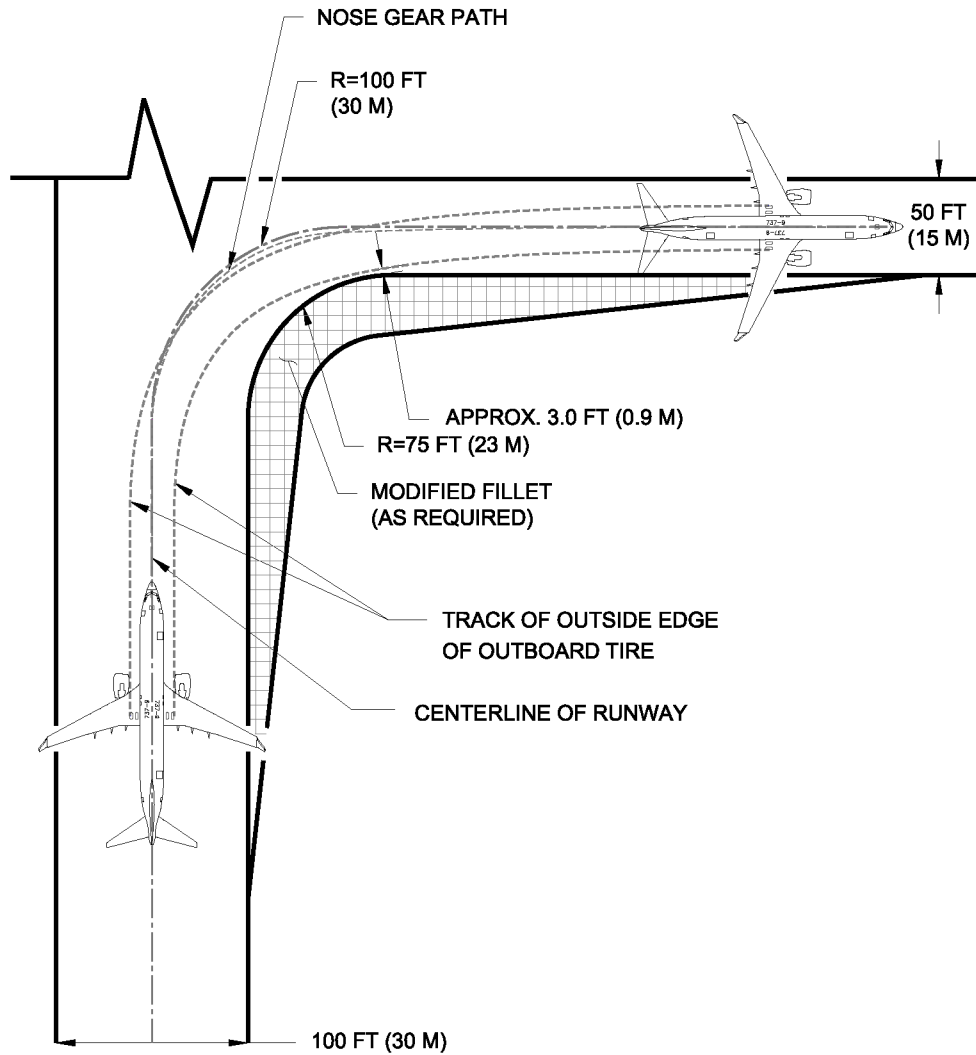

COCKPIT OVER CENTERLINE

4.5.9 Runway and Taxiway Turnpaths - Taxiway-to-Taxiway, 90-Degree Turn: Model 737-9 / BBJ MAX 9

NOTE: BEFORE DETERMINING THE SIZE OF A FILLET, CHECK WITH THE OPERATING AIRLINES REGARDING THE OPERATING PROCEDURES IN USE AND THE AIRCRAFT TYPES INTENDED TO SERVE THE AIRPORT.

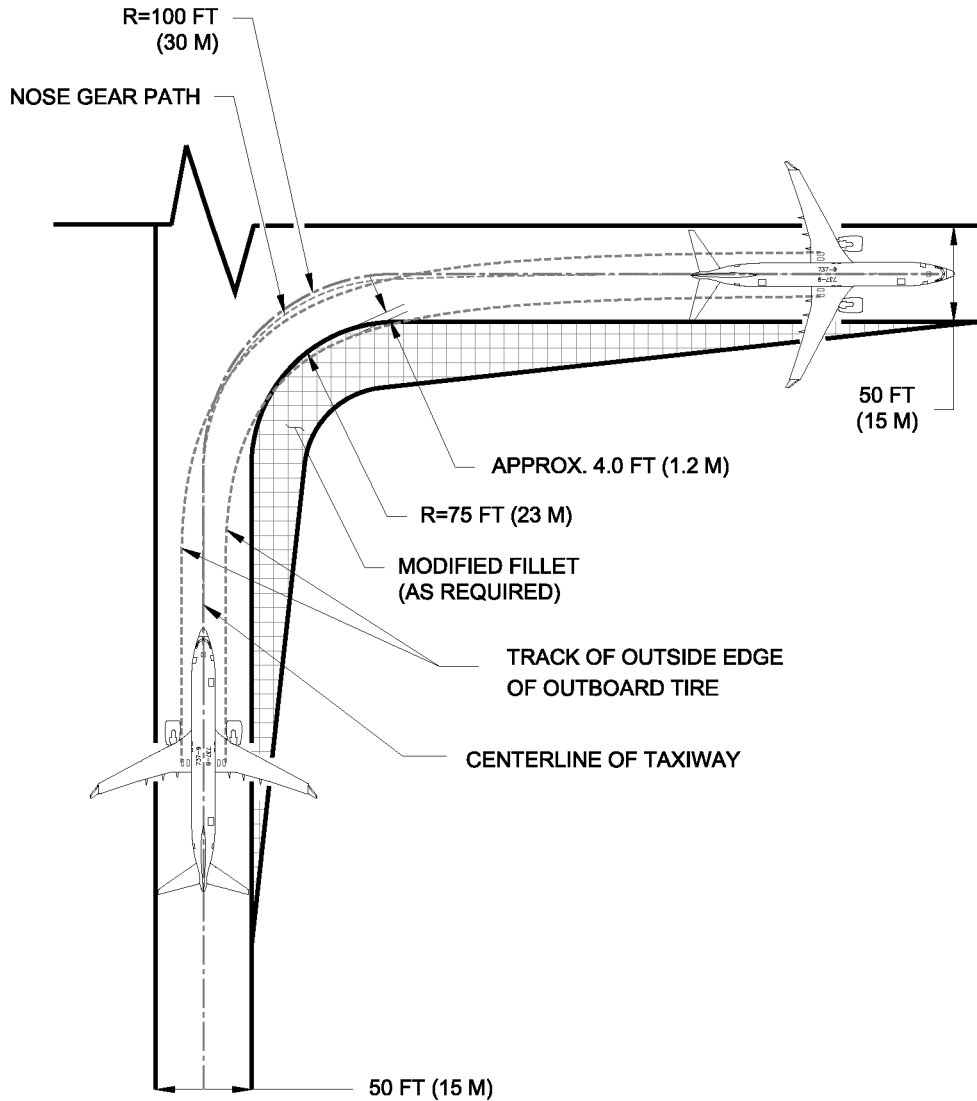

COCKPIT OVER CENTERLINE

4.5.10 Runway and Taxiway Turnpaths - Runway-to-Taxiway, More Than 90-Degree Turn: Model 737-10

NOTE: BEFORE DETERMINING THE SIZE OF A FILLET, CHECK WITH THE OPERATING AIRLINES REGARDING THE OPERATING PROCEDURES IN USE AND THE AIRCRAFT TYPES INTENDED TO SERVE THE AIRPORT.

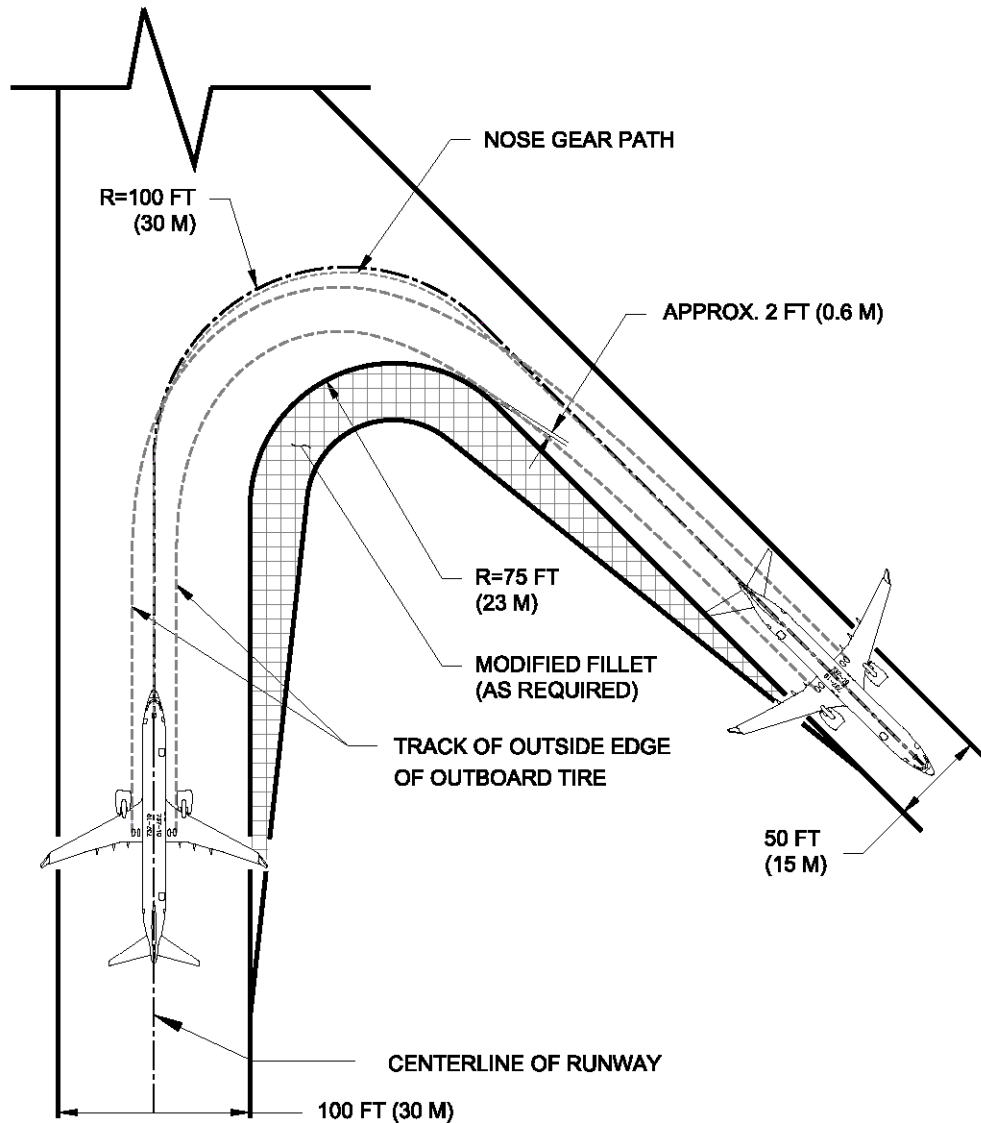

COCKPIT OVER CENTERLINE

4.5.11 Runway and Taxiway Turnpaths - Runway-to-Taxiway, 90-Degree Turn: Model 737-10

NOTE: BEFORE DETERMINING THE SIZE OF A FILLET, CHECK WITH THE OPERATING AIRLINES REGARDING THE OPERATING PROCEDURES IN USE AND THE AIRCRAFT TYPES INTENDED TO SERVE THE AIRPORT.

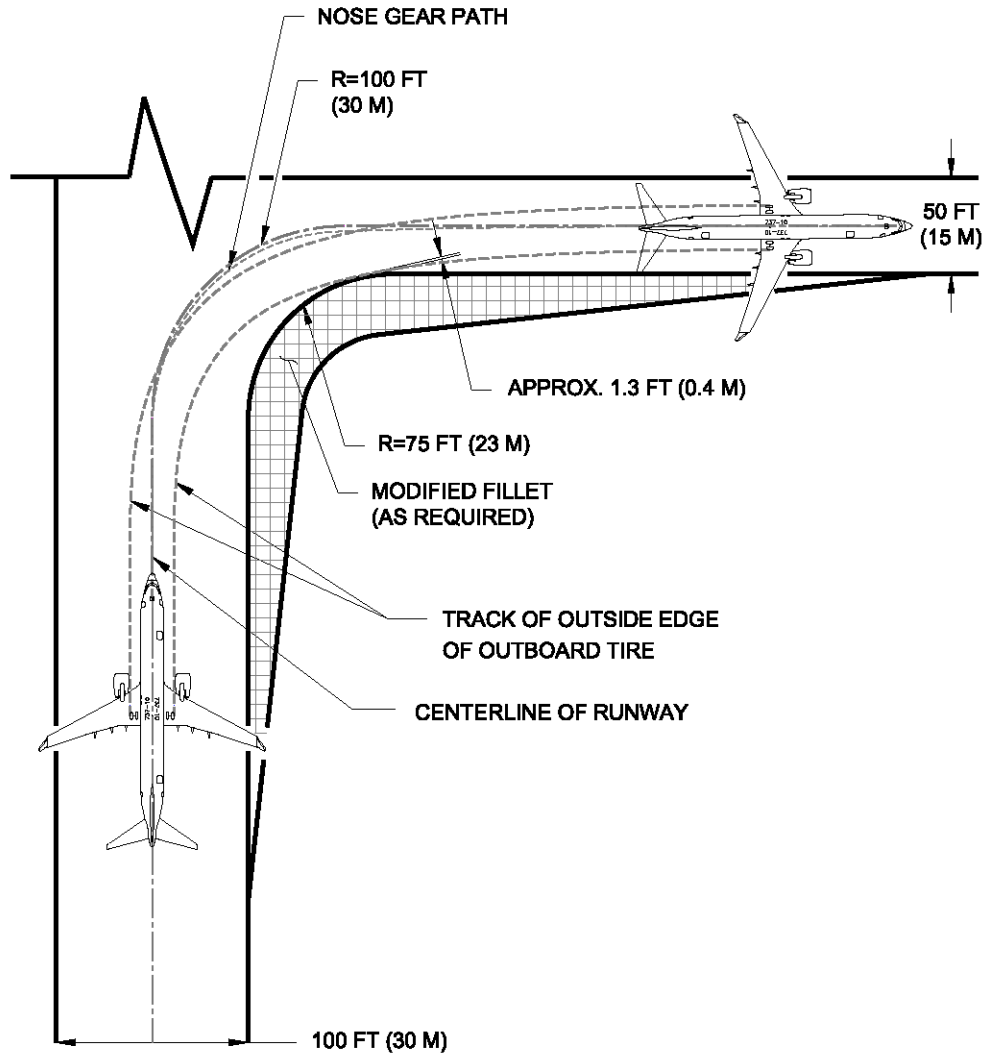

COCKPIT OVER CENTERLINE

4.5.12 Runway and Taxiway Turnpaths - Taxiway-to-Taxiway, 90-Degree Turn: Model 737-10

NOTE: BEFORE DETERMINING THE SIZE OF A FILLET, CHECK WITH THE OPERATING AIRLINES REGARDING THE OPERATING PROCEDURES IN USE AND THE AIRCRAFT TYPES INTENDED TO SERVE THE AIRPORT.

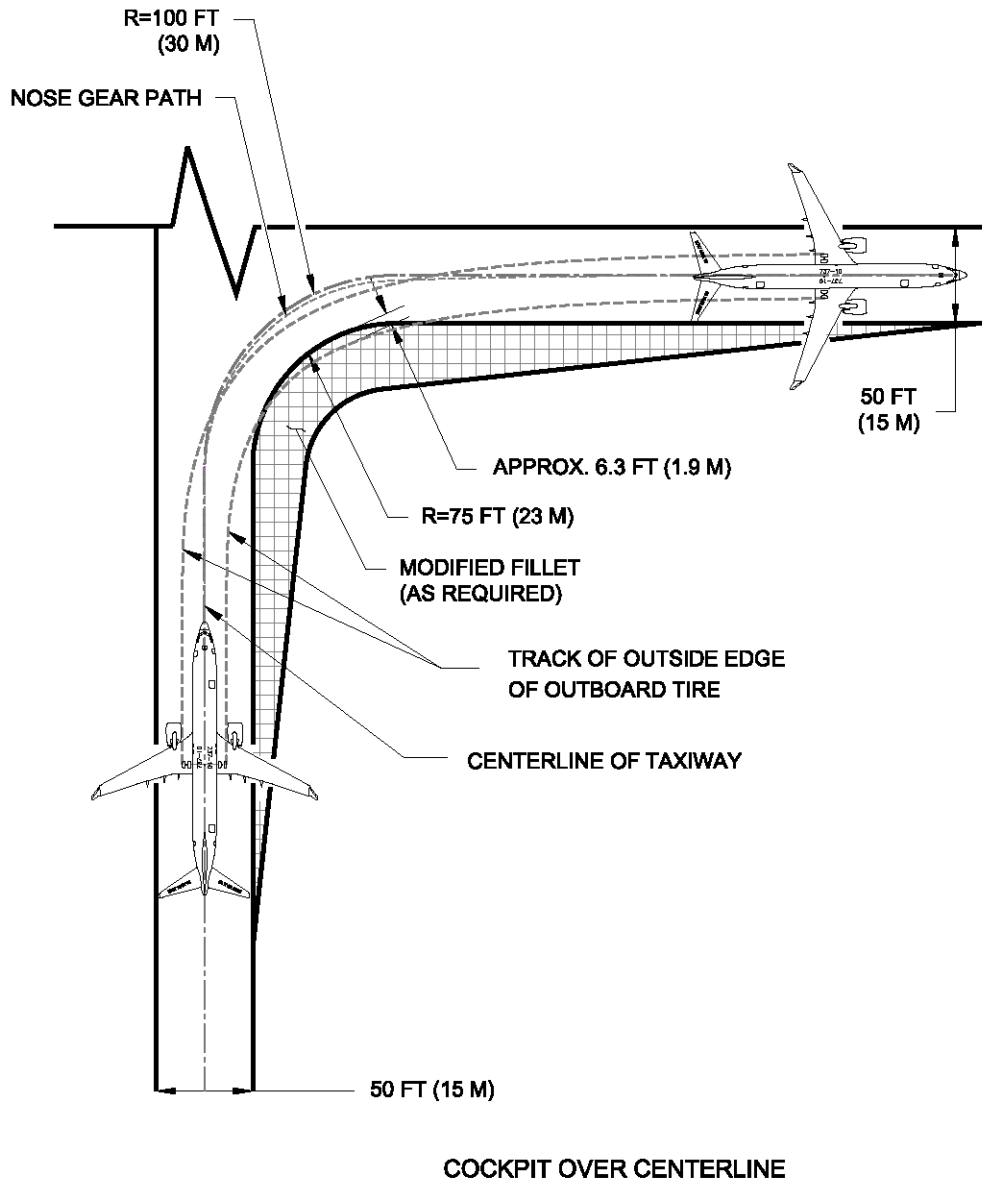

4.6 RUNWAY HOLDING BAY: MODEL 737, ALL MODELS

NOTE: BEFORE DETERMINING THE SIZE OF A HOLDING BAY, CHECK WITH THE OPERATING AIRLINES REGARDING THE OPERATING PROCEDURES IN USE AND THE AIRCRAFT TYPES INTENDED TO SERVE THE AIRPORT.

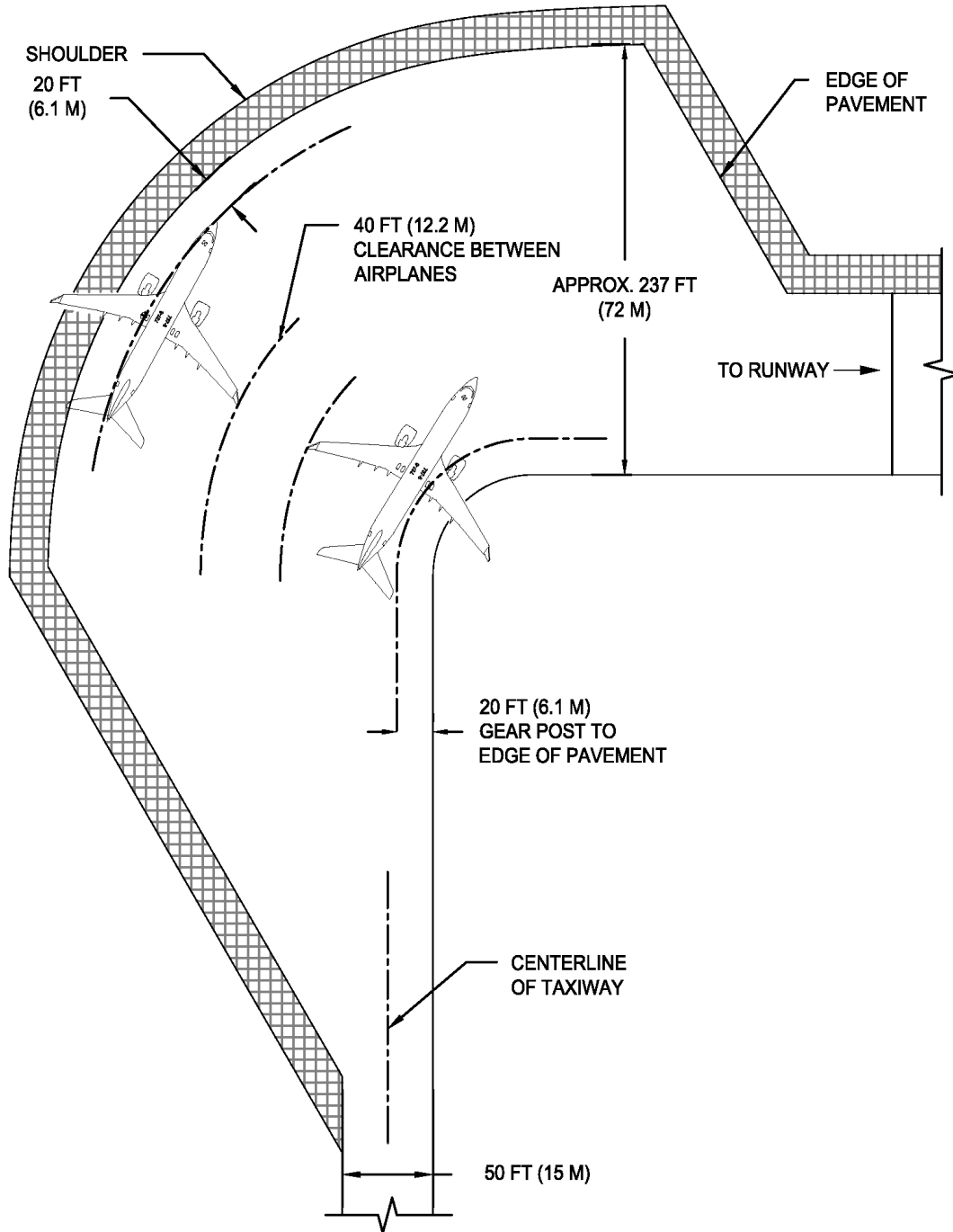

5.0 TERMINAL SERVICING

During turnaround at the terminal, certain services must be performed on the aircraft, usually within a given time, to meet flight schedules. This section shows service vehicle arrangements, schedules, locations of service points, and typical service requirements. The data presented in this section reflect ideal conditions for a single airplane. Service requirements may vary according to airplane condition and airline procedure.

Section 5.1 shows typical arrangements of ground support equipment during turnaround. When the auxiliary power unit (APU) is used, the electrical, air start, and air-conditioning service vehicles may not be required. Passenger loading bridges or portable passenger stairs could be used to load or unload passengers.

Sections 5.2 and 5.3 show typical service times at the terminal. These charts give typical schedules for performing service on the airplane within a given time. Service times could be rearranged to suit availability of personnel, airplane configuration, and degree of service required.

Section 5.4 shows the locations of ground service connections in graphic and in tabular forms. Typical capacities and service requirements are shown in the tables. Services with requirements that vary with conditions are described in subsequent sections.

Section 5.5 shows typical sea level air pressure and flow requirements for starting different engines. The curves are based on an engine start time of 90 seconds.

Section 5.6 shows pneumatic requirements for heating and cooling (air conditioning) using high pressure air to run the air cycle machine. The curves show airflow requirements to heat or cool the airplane within a given time and ambient conditions. Maximum allowable pressure and temperature for air cycle machine operation are 60 psia and 450°F, respectively.

Section 5.7 shows pneumatic requirements for heating and cooling the airplane, using low pressure conditioned air. This conditioned air is supplied through an 8-in ground air connection (GAC) directly to the passenger cabin, bypassing the air cycle machines.

Section 5.8 shows ground towing requirements for various ground surface conditions.

5.1 AIRPLANE SERVICING ARRANGEMENT - TYPICAL TURNAROUND

5.1.1 Airplane Servicing Arrangement - Typical Turnaround: Model 737-7

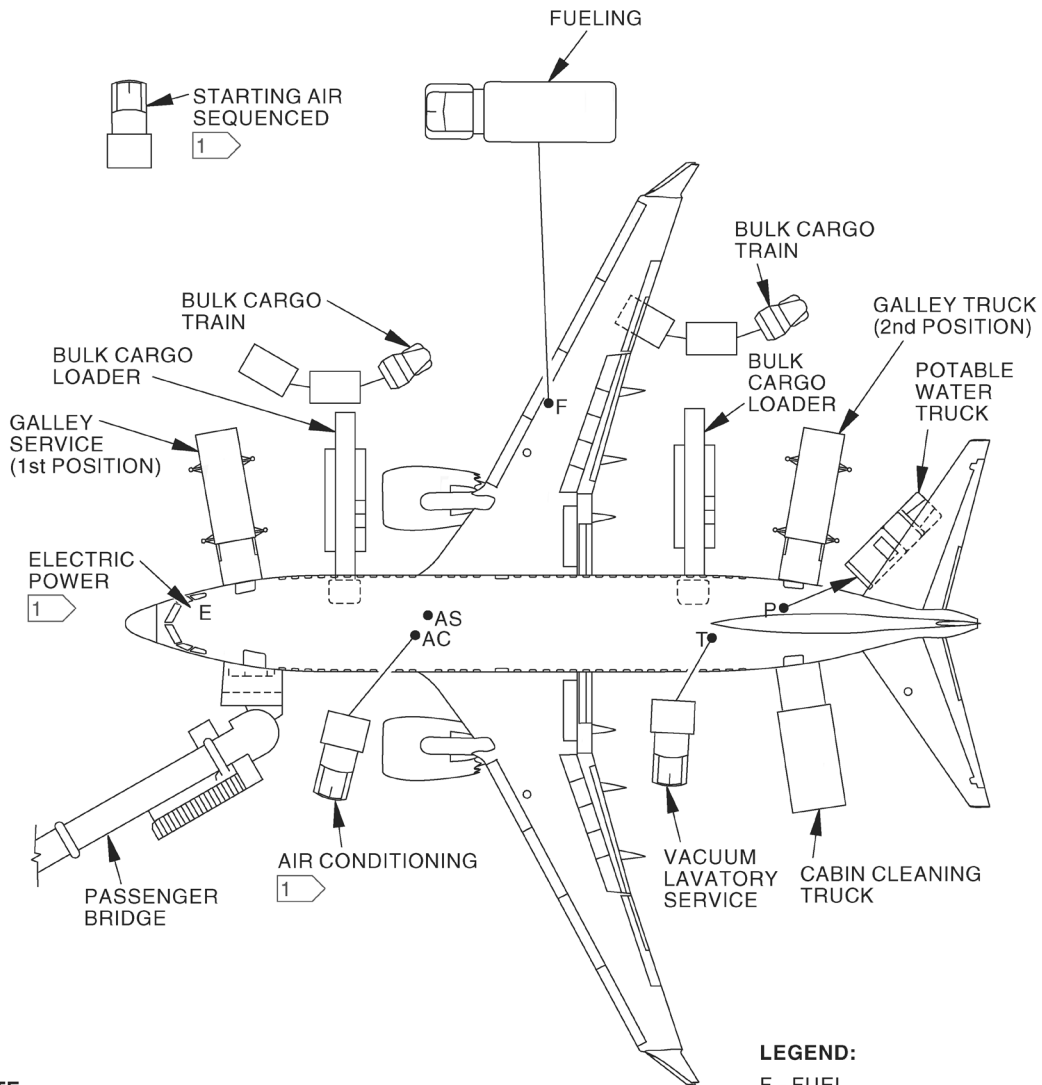

NOTE:
 [1] NOT REQUIRED IF APU IS IN USE

LEGEND:
 F - FUEL
 T - TOILET SERVICE
 P - POTABLE WATER
 E - ELECTRICAL POWER
 AC - AIR CONDITIONING
 AS - AIR START

5.1.2 Airplane Servicing Arrangement - Typical Turnaround: Model 737-8 / -8-200 / BBJ MAX 8

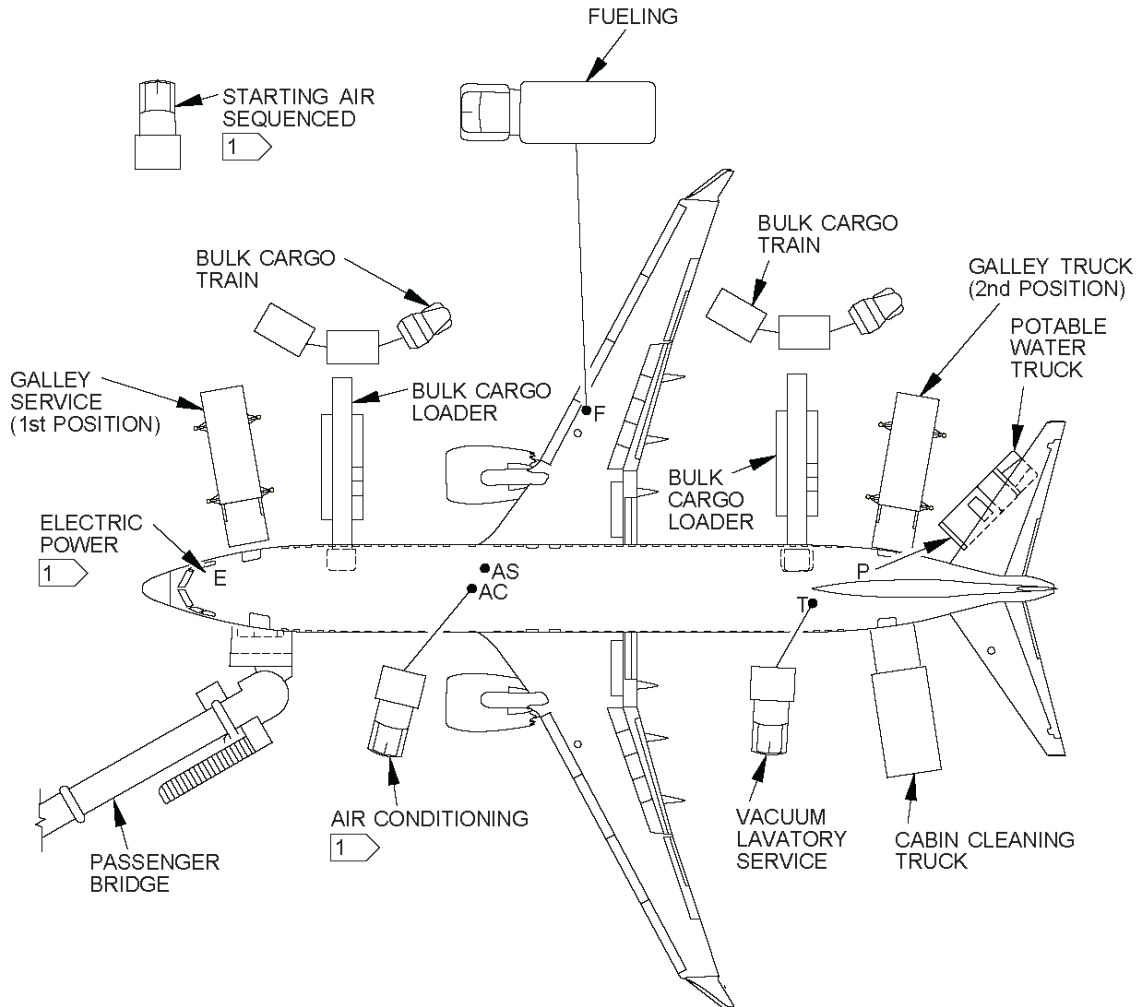

NOTE:

1 NOT REQUIRED IF APU IS IN USE

LEGEND:

- F - FUEL
- T - TOILET SERVICE
- P - POTABLE WATER
- E - ELECTRICAL POWER
- AC - AIR CONDITIONING
- AS - AIR START

5.1.3 Airplane Servicing Arrangement - Typical Turnaround: Model 737-9 / BBJ MAX 9

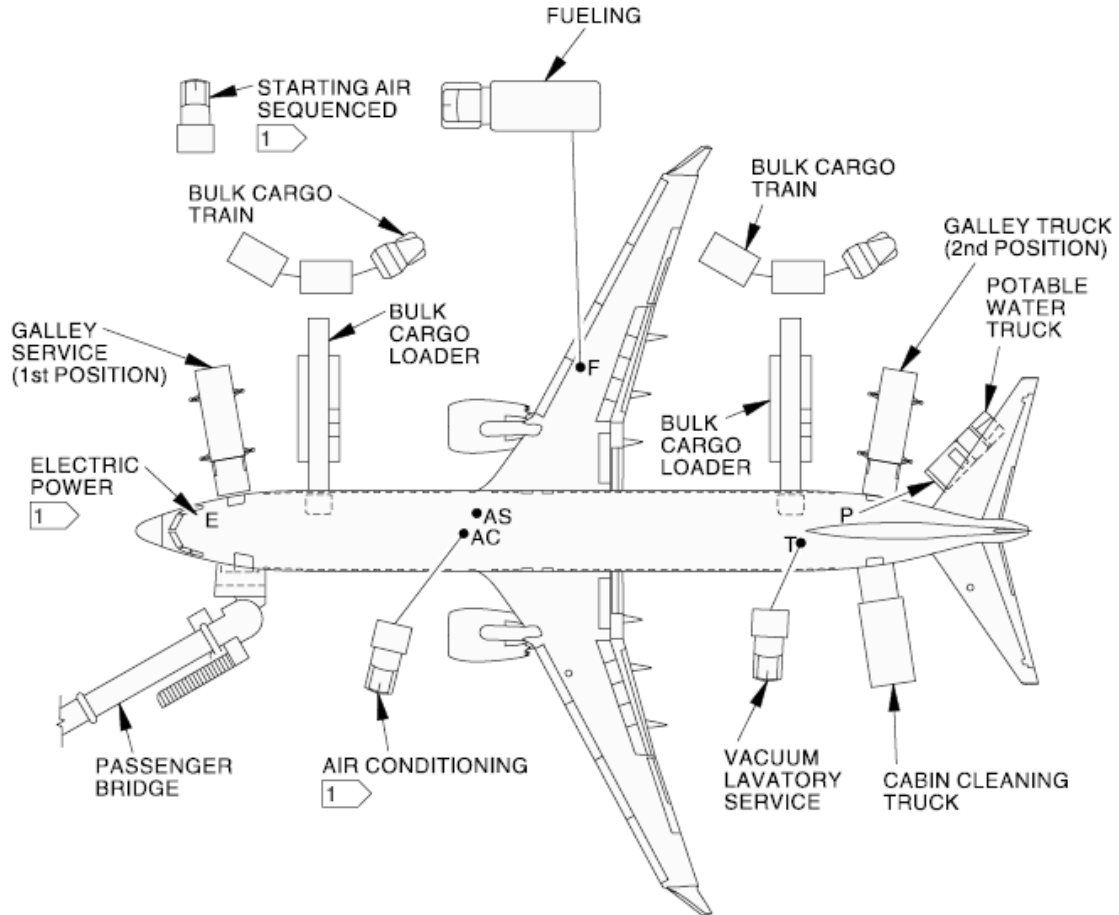

NOTE:

1 NOT REQUIRED IF APU IS IN USE

LEGEND:

- F - FUEL
- T - TOILET SERVICE
- P - POTABLE WATER
- E - ELECTRICAL POWER
- AC - AIR CONDITIONING
- AS - AIR START

5.1.4 Airplane Servicing Arrangement - Typical Turnaround: Model 737-10

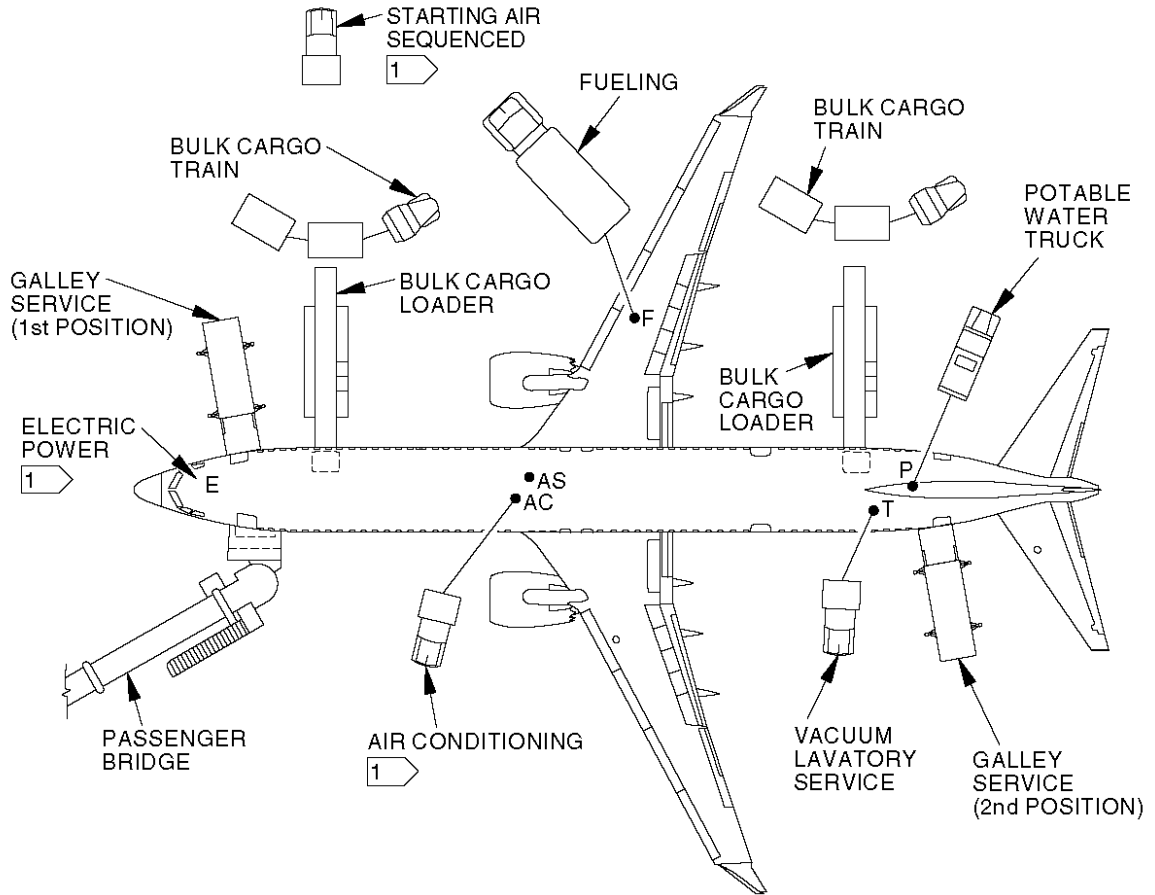

NOTE:

1 NOT REQUIRED IF APU IS IN USE

LEGEND:

- F - FUEL
- T - TOILET SERVICE
- P - POTABLE WATER
- E - ELECTRICAL POWER
- AC - AIR CONDITIONING
- AS - AIR START

5.1.5 Airplane Servicing Arrangement - Typical En Route: All Models

737-8 Shown

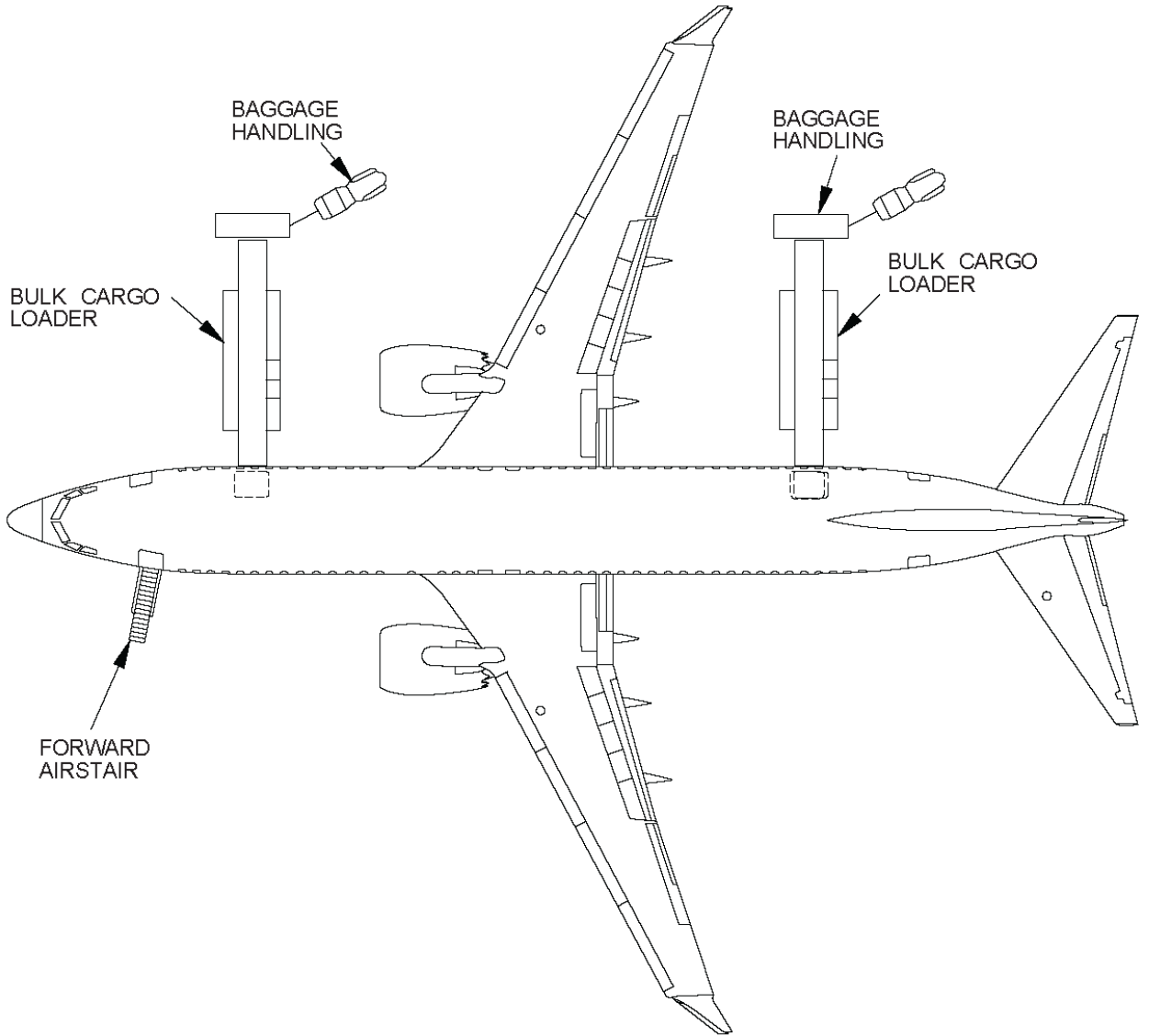

5.2 TERMINAL OPERATIONS - TURNAROUND STATION

5.2.1 Terminal Operations – Turnaround Station: Model 737-7

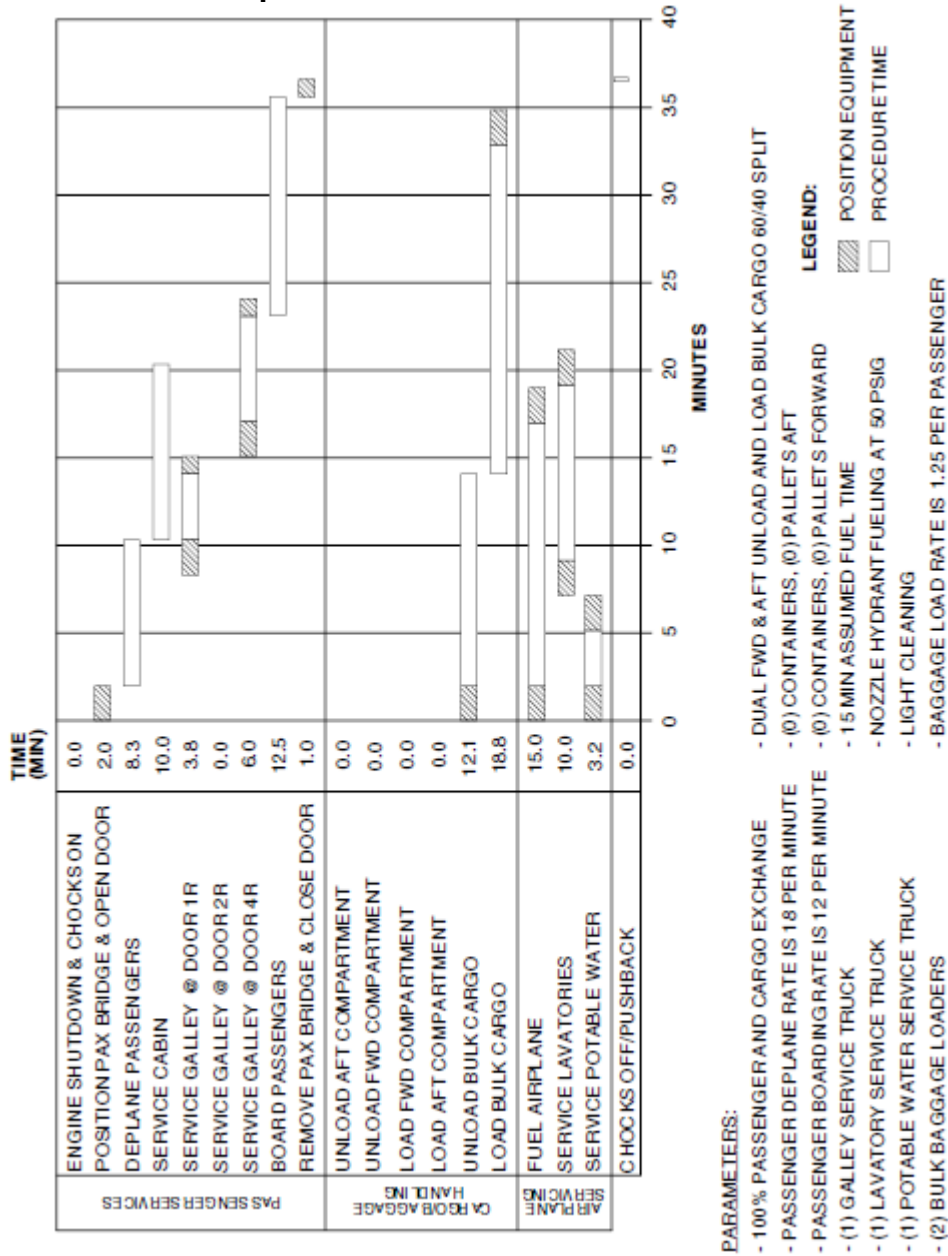

5.2.2 Terminal Operations – Turnaround Station: Model 737-8

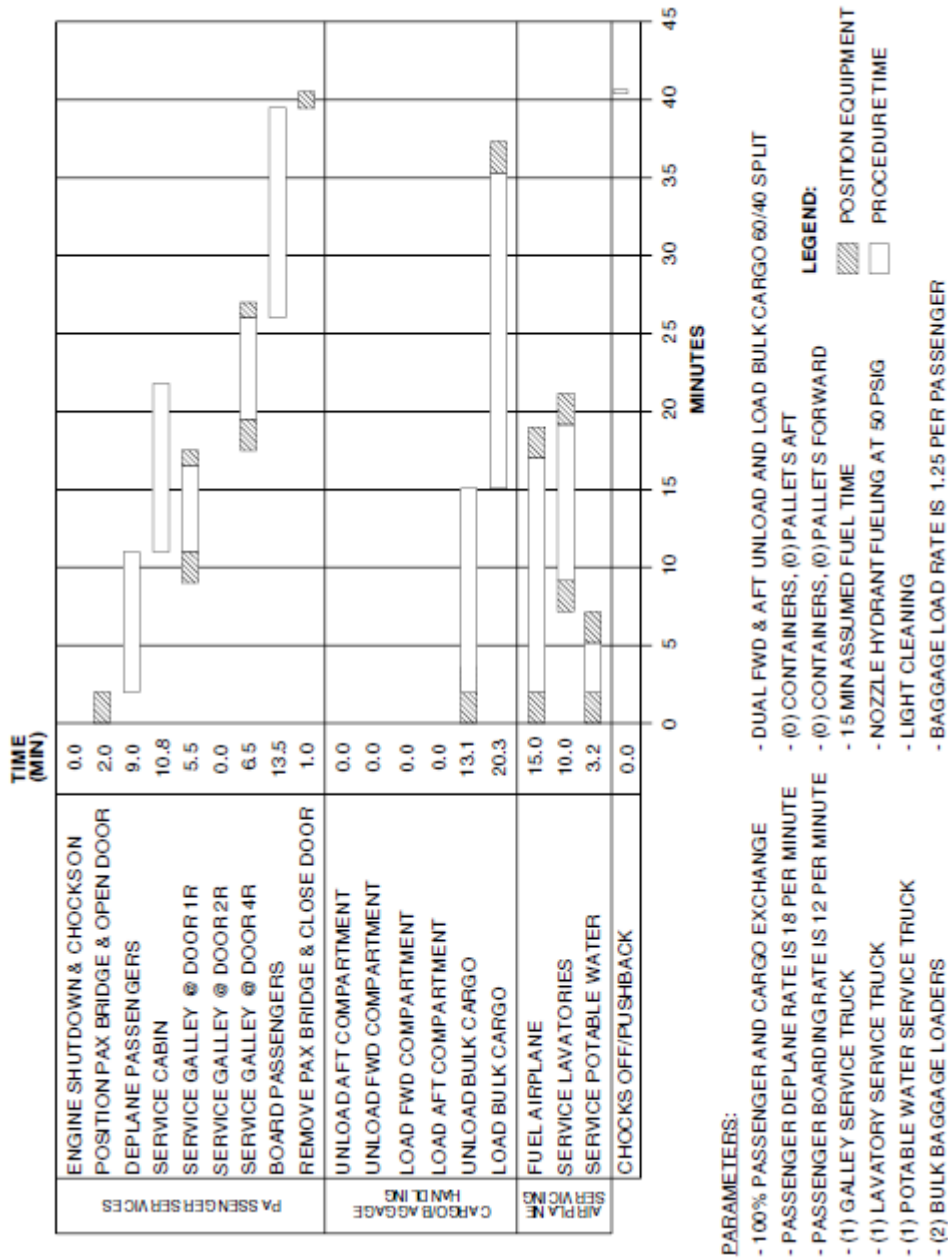

5.2.3 Terminal Operations – Turnaround Station: Model 737-8-200

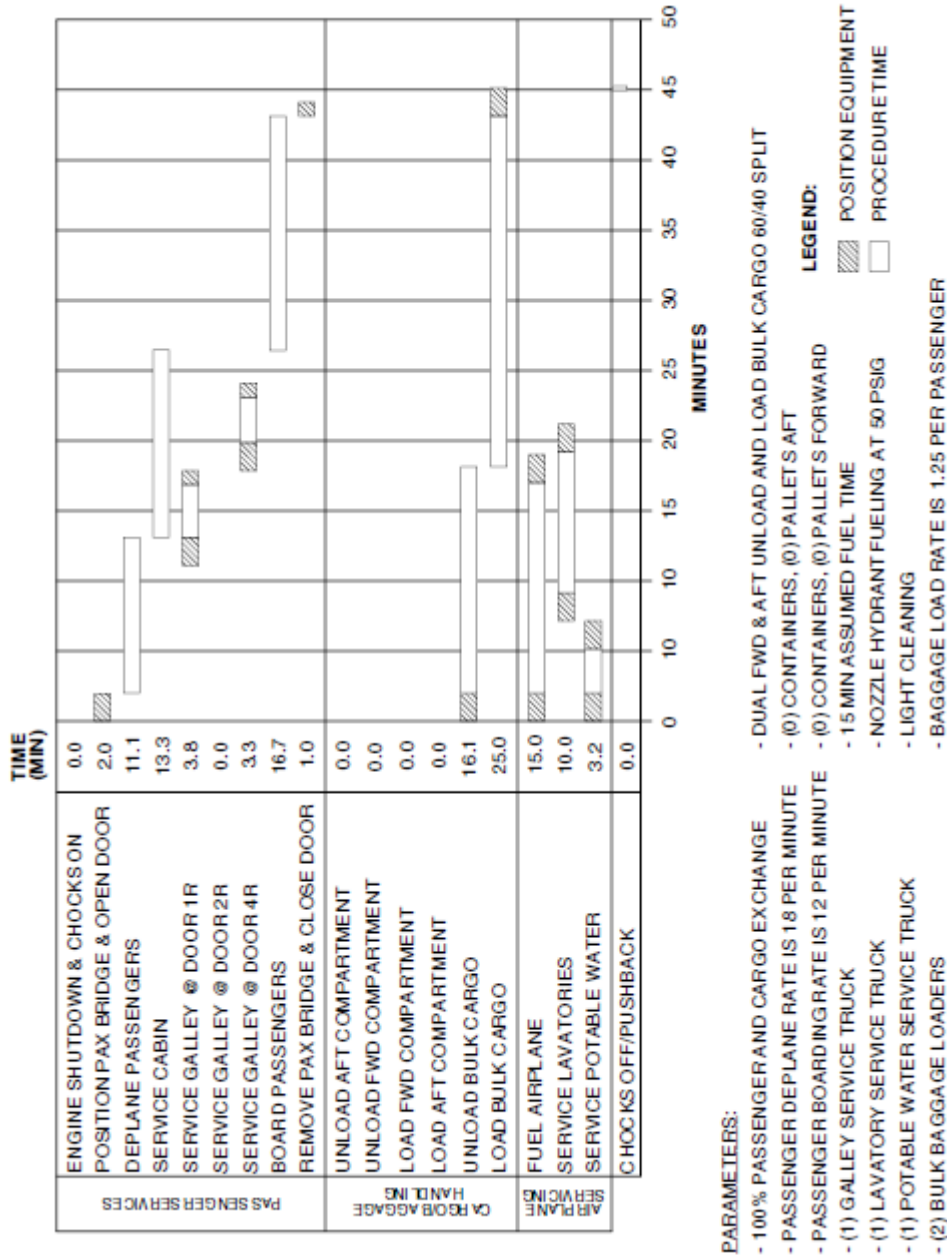

5.2.4 Terminal Operations – Turnaround Station: Model 737-9

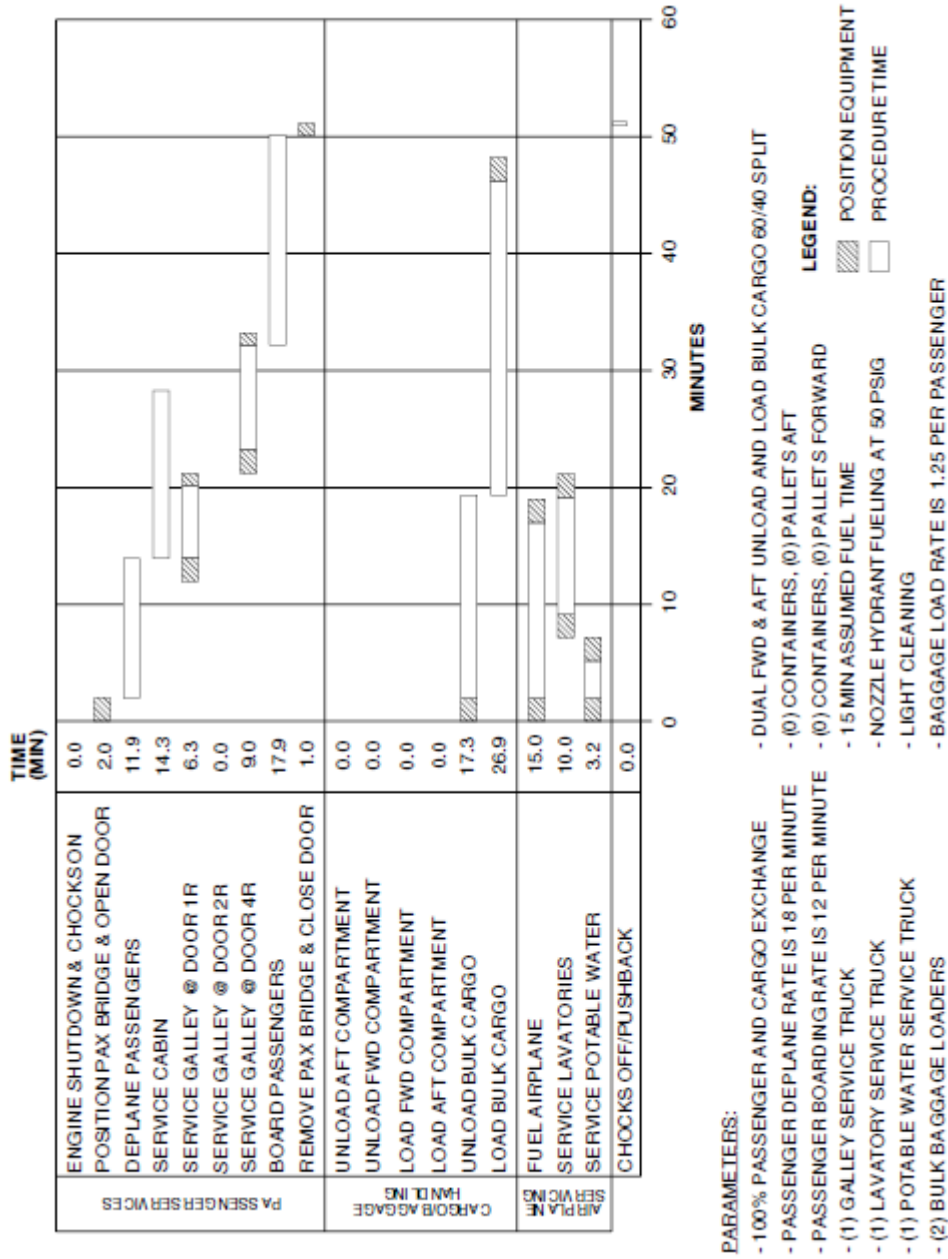

5.2.5 Terminal Operations – Turnaround Station: Model 737-10

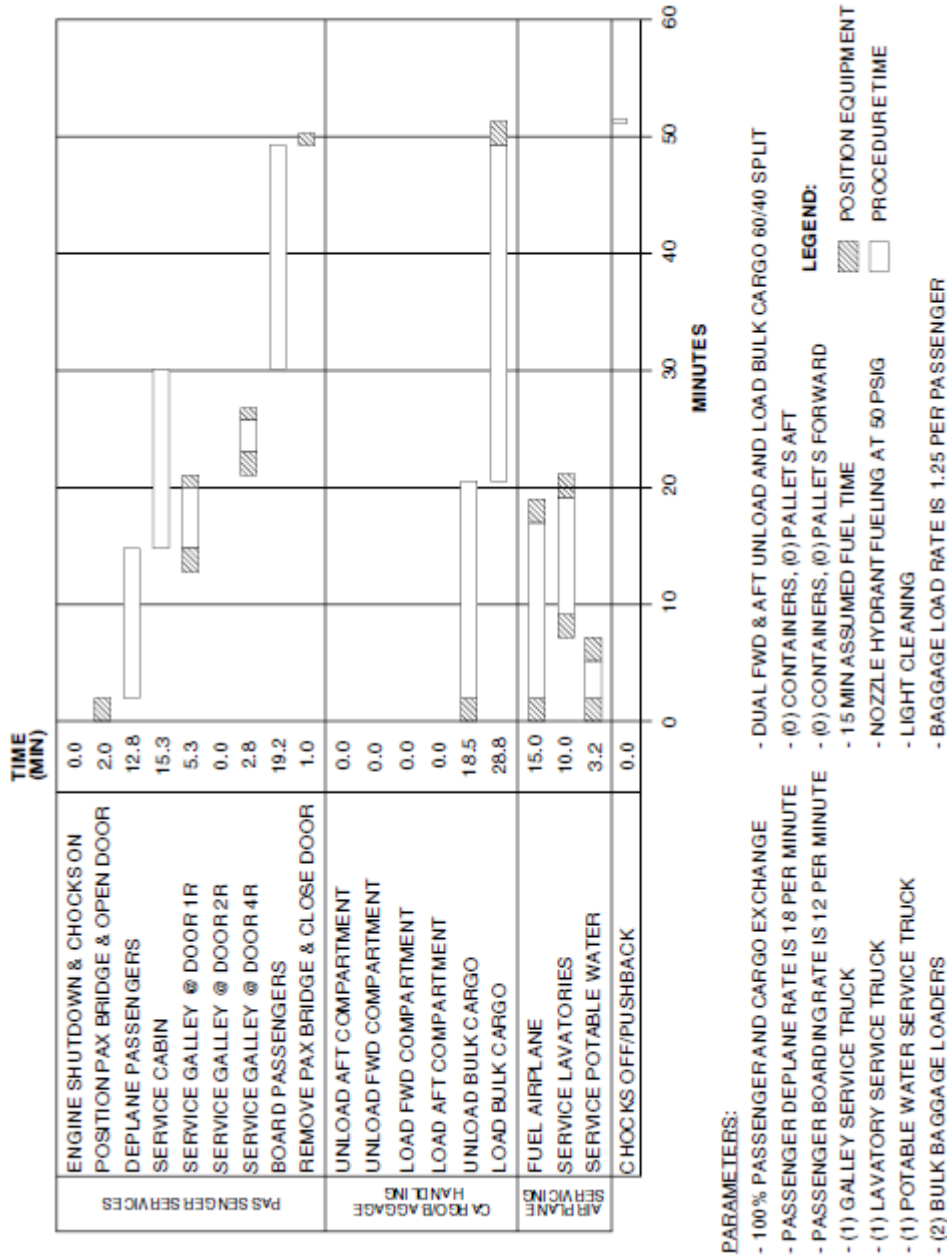

5.3 TERMINAL OPERATIONS - EN ROUTE STATION

5.3.1 Terminal Operations - En Route Station: Model 737-7

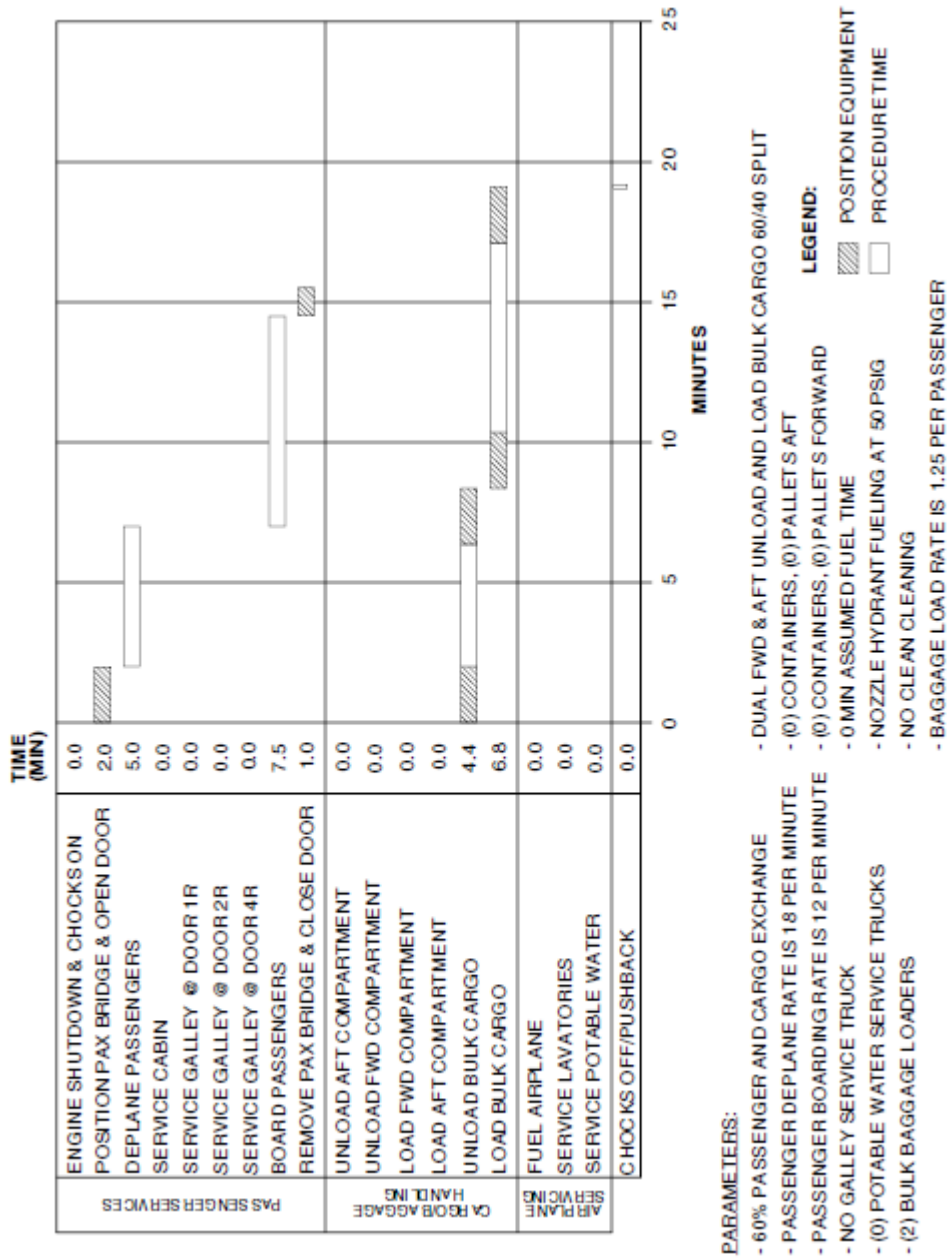

5.3.2 Terminal Operations - En Route Station: Model 737-8

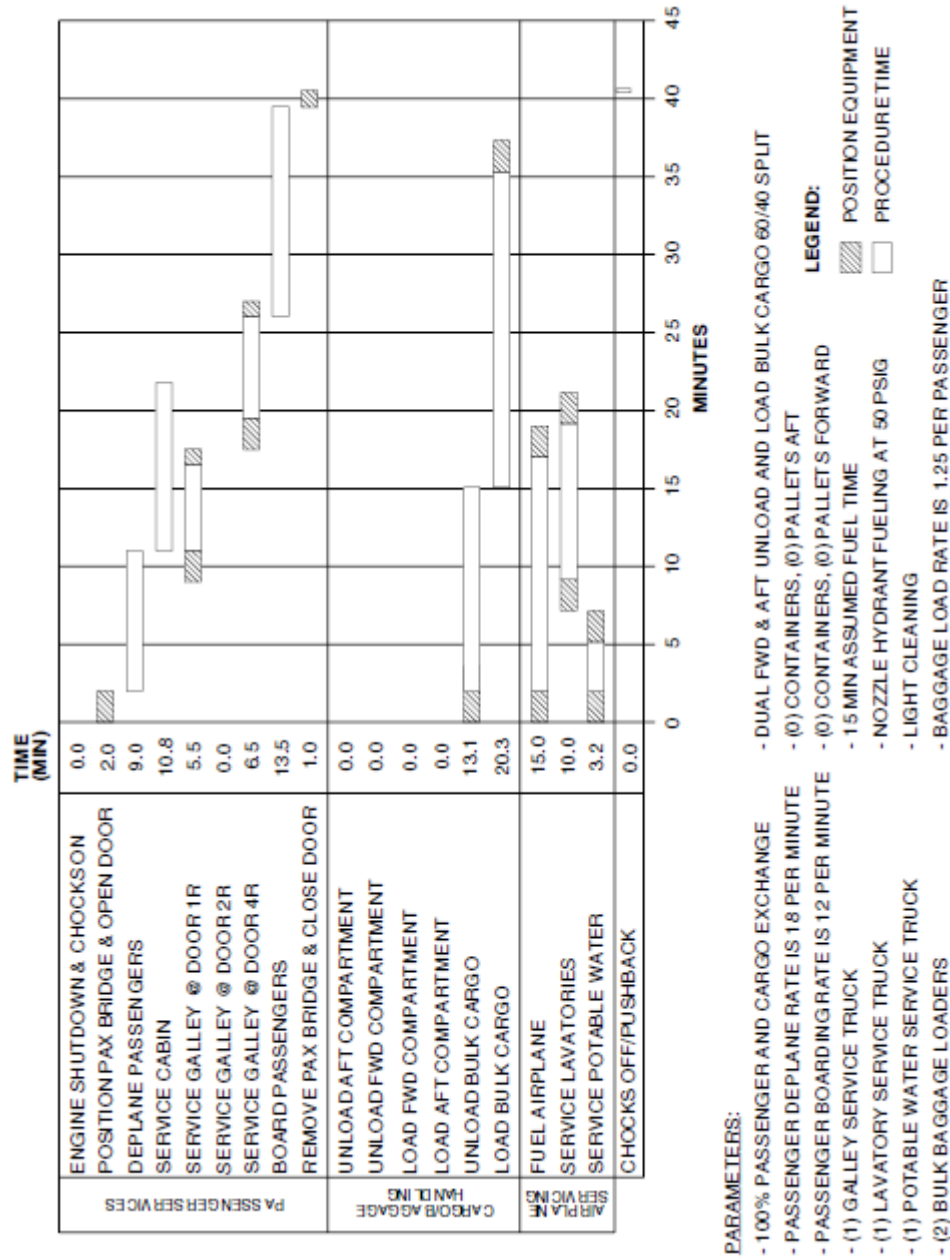

5.3.3 Terminal Operations - En Route Station: Model 737-8-200

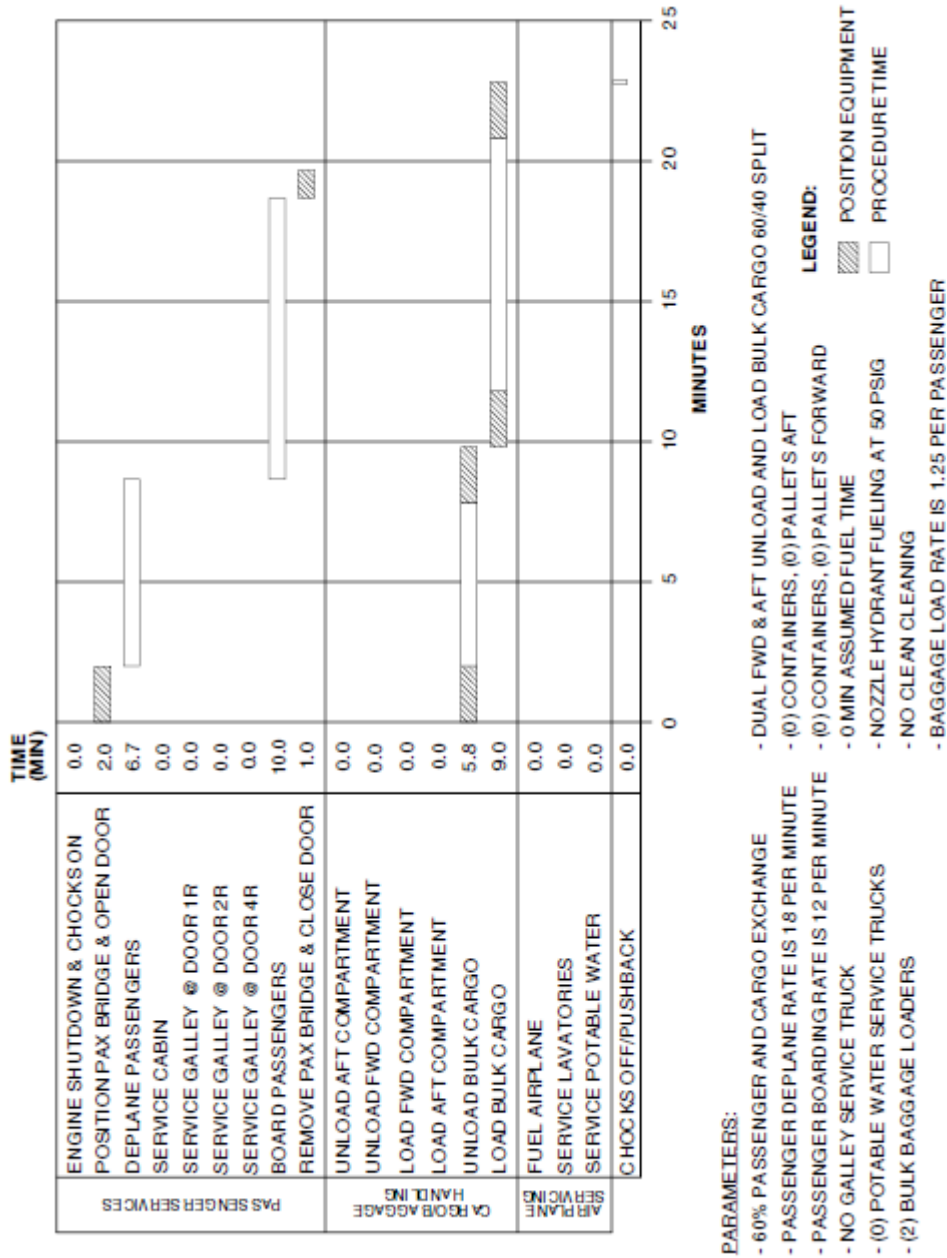

5.3.4 Terminal Operations - En Route Station: Model 737-9

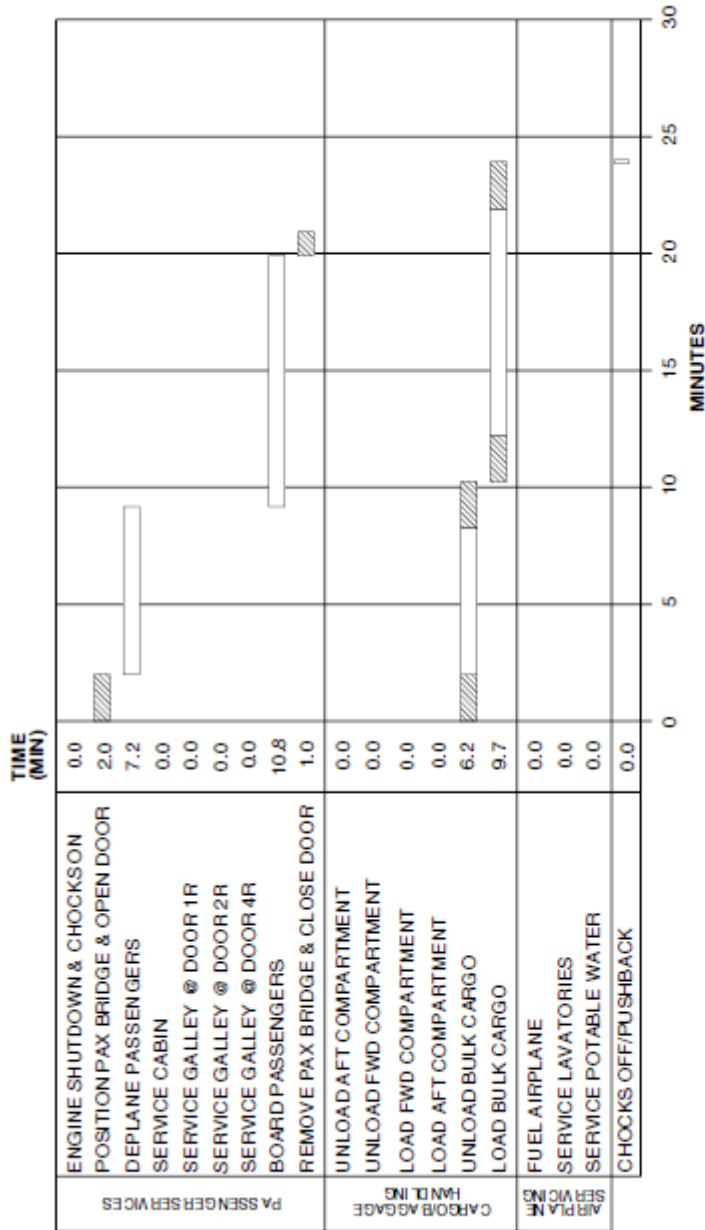

PARAMETERS:

- 60% PASSENGER AND CARGO EXCHANGE
- PASSENGER DEPLANE RATE IS 18 PER MINUTE
- PASSENGER BOARDING RATE IS 12 PER MINUTE
- NO GALLEY SERVICE TRUCK
- (0) POTABLE WATER SERVICE TRUCKS
- (2) BULK BAGGAGE LOADERS

LEGEND:

- DUAL FWD & AFT UNLOAD AND LOAD BULK CARGO 60/40 SPLIT
- (0) CONTAINERS, (0) PALLETS AFT
- (0) CONTAINERS, (0) PALLETS FORWARD
- 0 MIN ASSUMED FUEL TIME
- NOZZLE HYDRANT FUELING AT 50 PSIG
- NO CLEAN CLEANING
- BAGGAGE LOAD RATE IS 1.25 PER PASSENGER

LEGEND:

- ▨ POSITION EQUIPMENT
- PROCEDURE TIME

5.3.5 Terminal Operations - En Route Station: Model 737-10

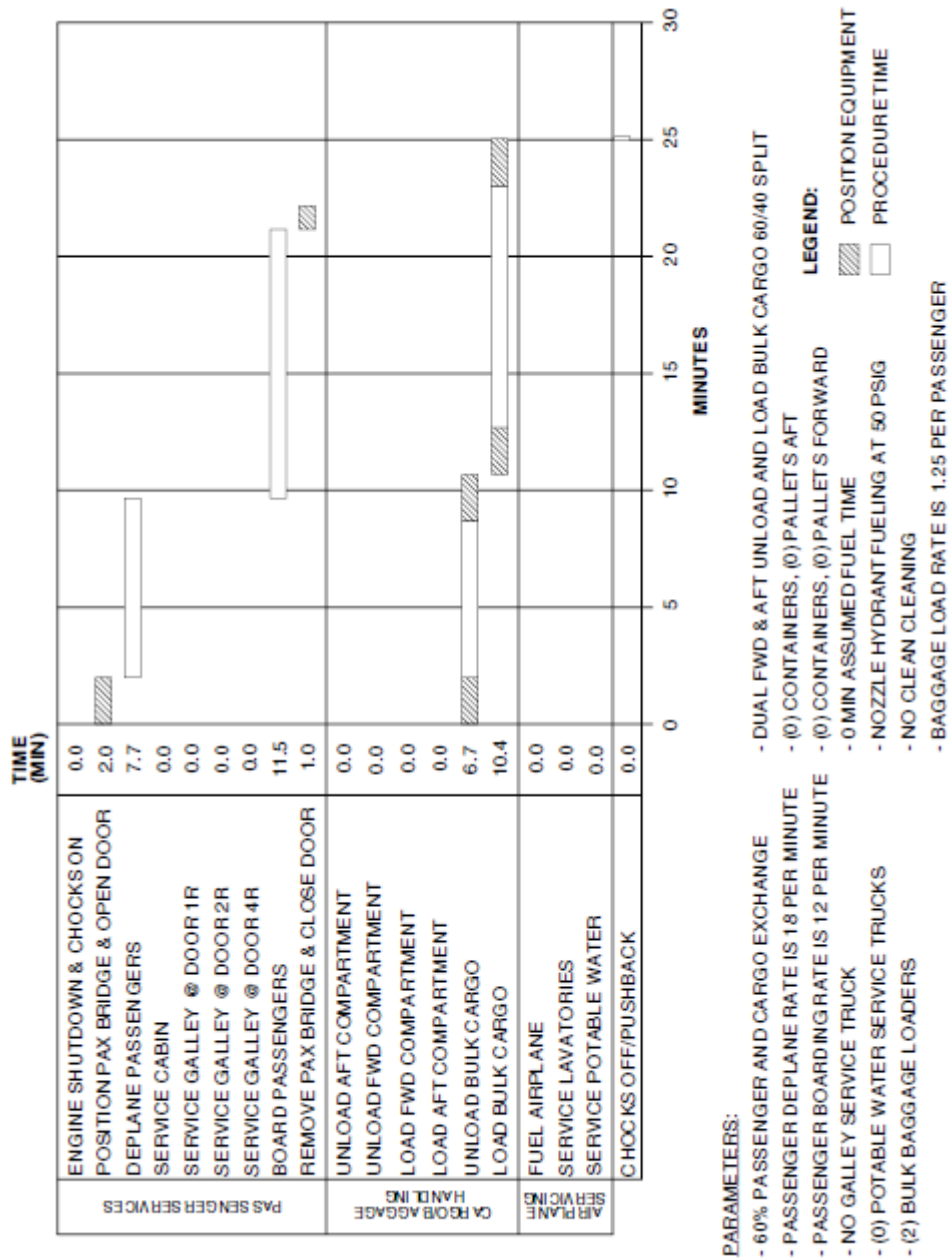

5.4 GROUND SERVICING CONNECTIONS

5.4.1 Ground Service Connections - Locations: Model 737-7

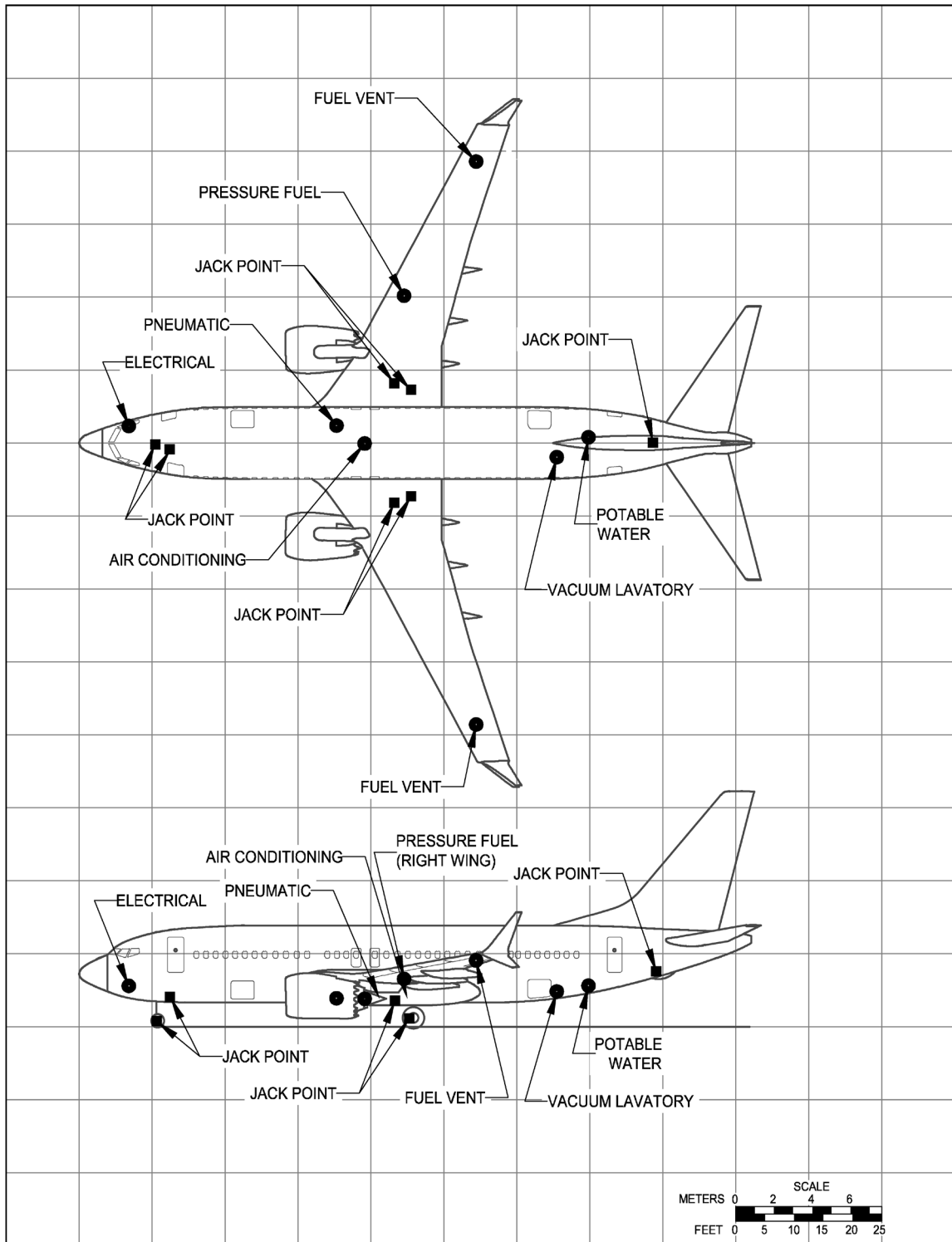

D6-38A004

5.4.2 Ground Service Connections - Locations: Model 737-8 /-8-200 / BBJ MAX 8

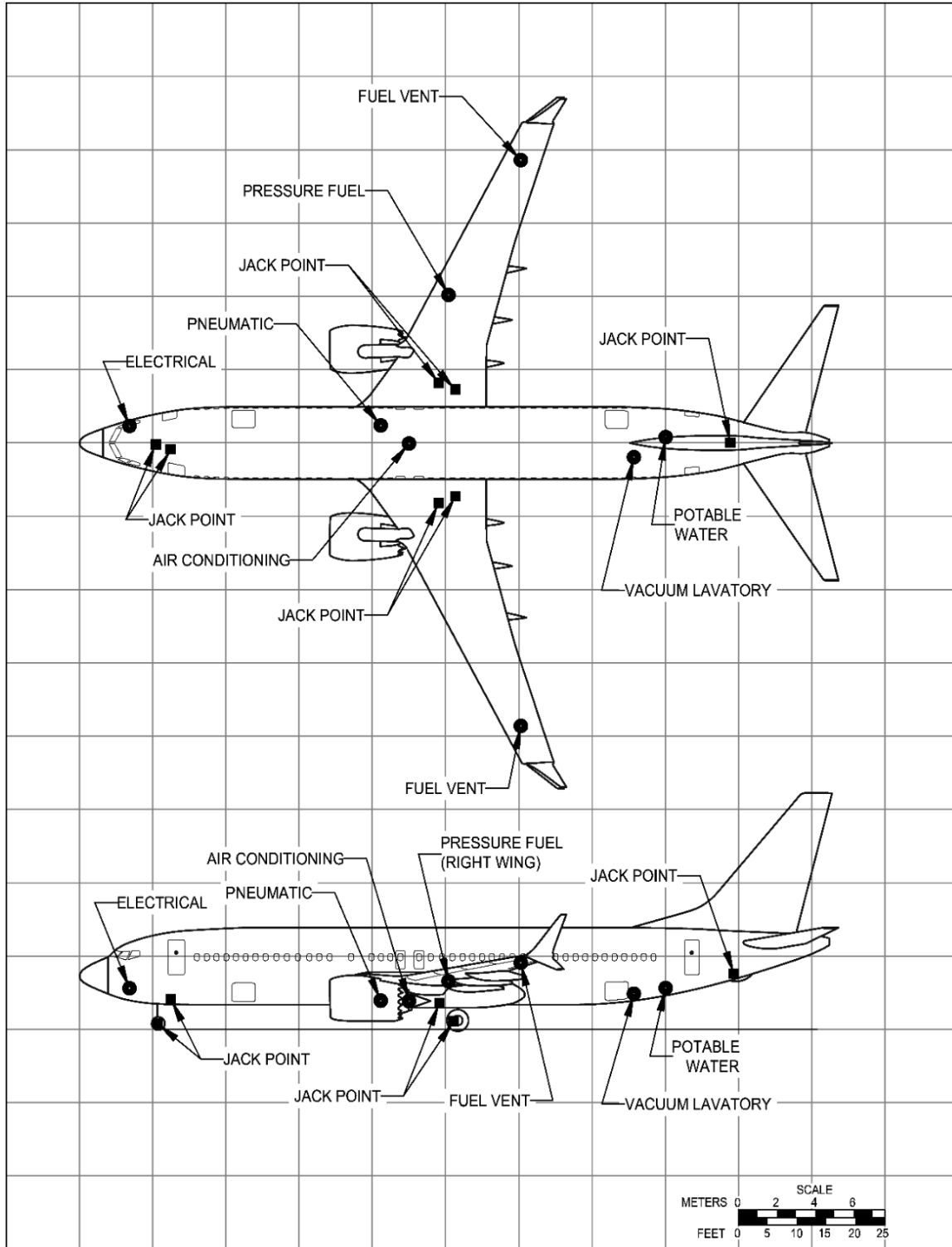

D6-38A004

5.4.3 Ground Service Connections - Locations: Model 737-9 / BBJ MAX 9

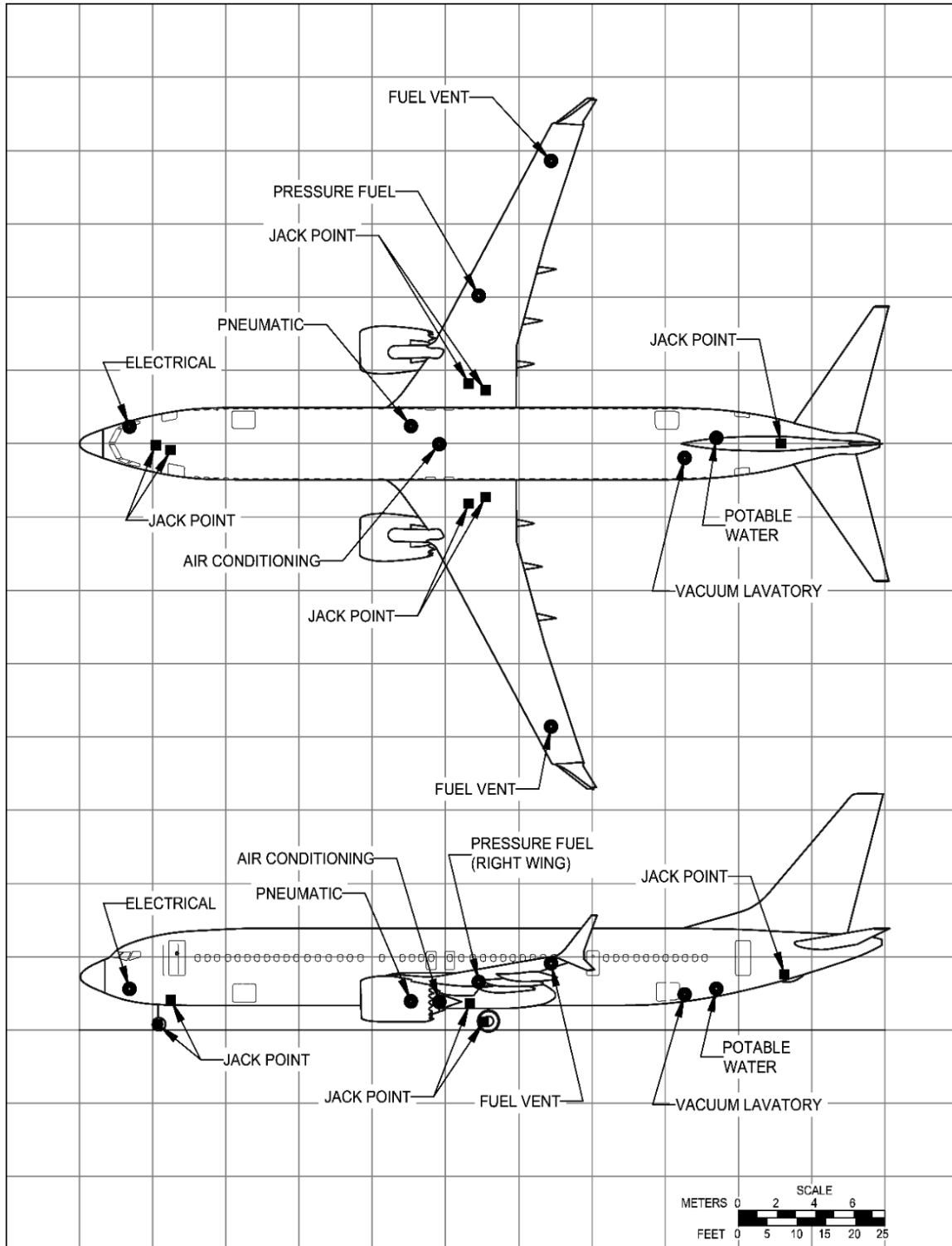

D6-38A004

5.4.4 Ground Service Connections - Locations: Model 737-10

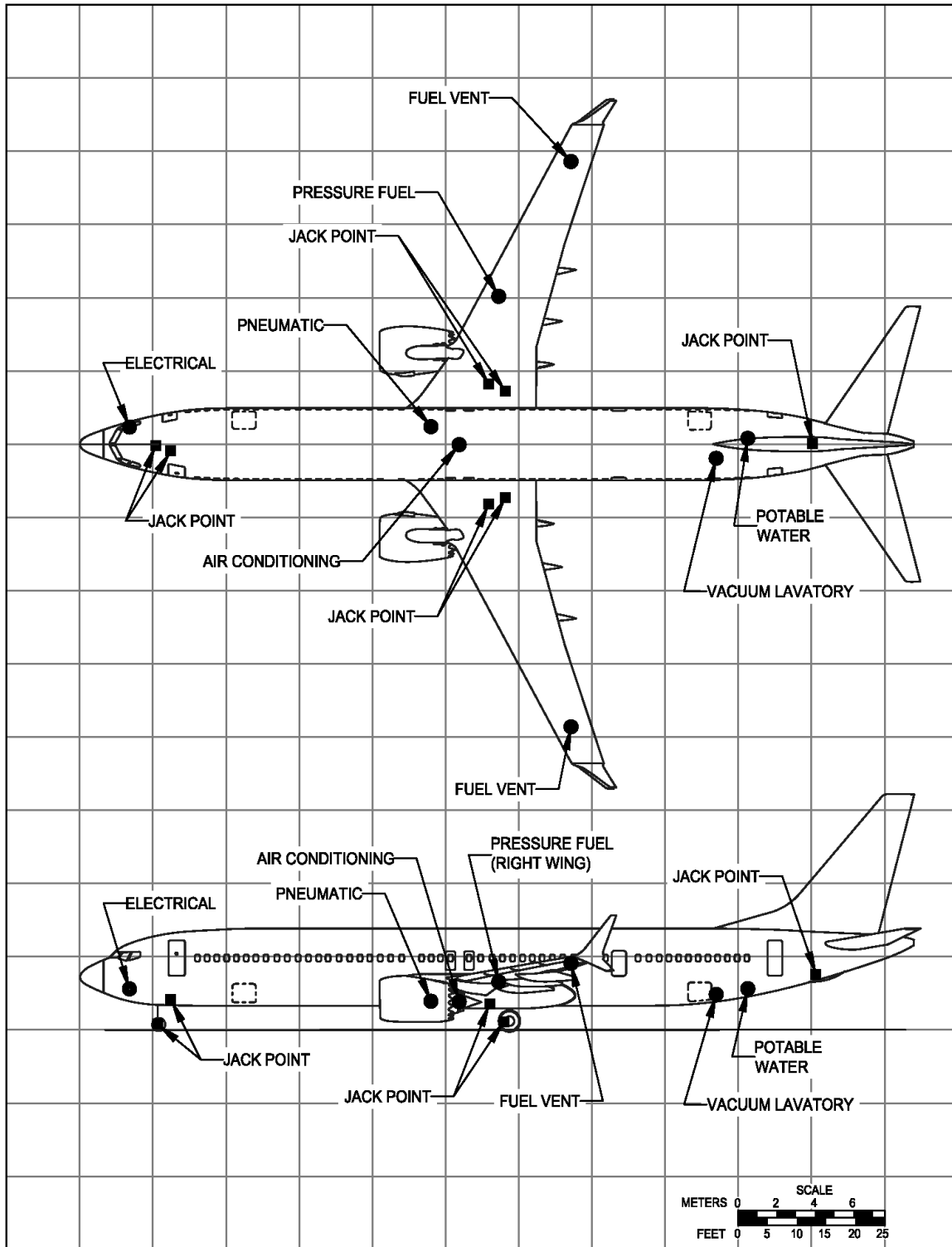

D6-38A004

5.4.5 Ground Servicing Connections and Capacities: All Models

SYSTEM	MODEL *[1]	DISTANCE *[2] AFT OF		DISTANCE *[2] FROM AIRPLANE CENTERLINE				MAX HEIGHT *[2] ABOVE	
		NOSE		LH SIDE		RH SIDE		GROUND	
		FT-IN	M	FT-IN	M	FT-IN	M	FT-IN	M
CONDITIONED AIR ONE 8-IN (20.3 CM) PORT	737-7	42 - 3	12.9	0	0	0	0	4 - 5	1.3
	737-8	49 - 7	15.1	0	0	0	0	4 - 5	1.3
	737-9	54 - 9	16.7	0	0	0	0	4 - 5	1.3
	737-10	58 - 1	17.7	0	0	0	0	4 - 6	1.4
ELECTRICAL ONE CONNECTION - 90 KVA, 115/200 VAC 400 HZ, 3-PHASE EACH	737-7	8 - 6	2.6	-	-	3 - 1	0.9	8 - 3	2.5
	737-8	8 - 6	2.6	-	-	3 - 1	0.9	8 - 2	2.5
	737-9	8 - 6	2.6	-	-	3 - 1	0.9	8 - 2	2.5
	737-10	8 - 6	2.6	-	-	3 - 1	0.9	8 - 2	2.5
FUEL ONE UNDERWING- PRESSURE CONNECTOR ON RIGHT WING TOTAL CAPACITY 6,820 GAL (25,817 LITERS)	737-7	55 - 8	17.0	-	-	25 - 3	7.7	9 - 8	2.9
	737-8	63 - 0	19.2	-	-	25 - 3	7.7	9 - 8	2.9
	737-9	68 - 2	20.8	-	-	25 - 3	7.7	9 - 8	2.9
	737-10	71 - 6	21.8	-	-	25 - 3	7.7	9 - 9	3.0
FUEL VENT FUEL VENT ON UNDERSIDE OF BOTH WINGTIPS	737-7	68 - 0	20.7	48 - 3	14.7	48 - 3	14.7	UNDERSIDE OF WING	
	737-8	75 - 4	22.0	48 - 3	14.7	48 - 3	14.7		
	737-9	80 - 6	24.5	48 - 3	14.7	48 - 3	14.7		
	737-10	83 - 10	25.6	48 - 3	14.7	48 - 3	14.7		
LAVATORY ONE CONNECTION FOR VACUUM LAVATORY	737-7	81 - 11	25.0	2 - 7	0.8	-	-	5 - 10	1.8
	737-8	94 - 9	28.9	2 - 7	0.8	-	-	5 - 10	1.8
	737-9	103 - 5	31.5	2 - 7	0.8	-	-	5 - 10	1.8
	737-10	108 - 11	33.2	2 - 7	0.8	-	-	5 - 11	1.8
OXYGEN CREW INDIVIDUAL CANISTERS IN EACH PASSENGER SERVICE UNIT	737-7	18 - 11	5.8	-	-	0 - 10	0.3	7 - 0	2.1
	737-8	18 - 11	5.8	-	-	0 - 10	0.3	7 - 0	2.1
	737-9	18 - 11	5.8	-	-	0 - 10	0.3	7 - 0	2.1
	737-10	18 - 11	5.8	-	-	0 - 10	0.3	7 - 0	2.1
PNEUMATIC ONE 3-IN (7.6-CM) PORT FOR ENGINE START AND AIRCONDITIONING PACKS	737-7	44 - 1	13.4	-	-	3 - 0	0.9	4 - 10	1.5
	737-8	51 - 5	15.7	-	-	3 - 0	0.9	4 - 10	1.5
	737-9	56 - 7	17.2	-	-	3 - 0	0.9	4 - 10	1.5
	737-10	59 - 11	18.3	-	-	3 - 0	0.9	4 - 11	1.5
POTABLE WATER ONE SERVICE CONNECTION 0.75-IN (1.9 CM)	737-7	87 - 3	26.6	-	-	1 - 0	0.3	6 - 4	1.9
	737-8	100 - 1	30.5	-	-	1 - 0	0.3	6 - 4	1.9
	737-9	108 - 9	33.1	-	-	1 - 0	0.3	6 - 4	1.9
	737-10	114 - 3	34.8	-	-	1 - 0	0.3	6 - 6	2.0

NOTES: *[1] 737-8 INCLUDES 737-8 / -8-200 / BBJ MAX 8; 737-9 INCLUDES 737-9 / BBJ MAX 9
*[2] DISTANCES OR HEIGHTS ROUNDED TO THE NEAREST INCH AND 0.1 METER

5.5 ENGINE STARTING PNEUMATIC REQUIREMENTS

5.5.1 Engine Start Pneumatic Requirements - Sea Level: All Models

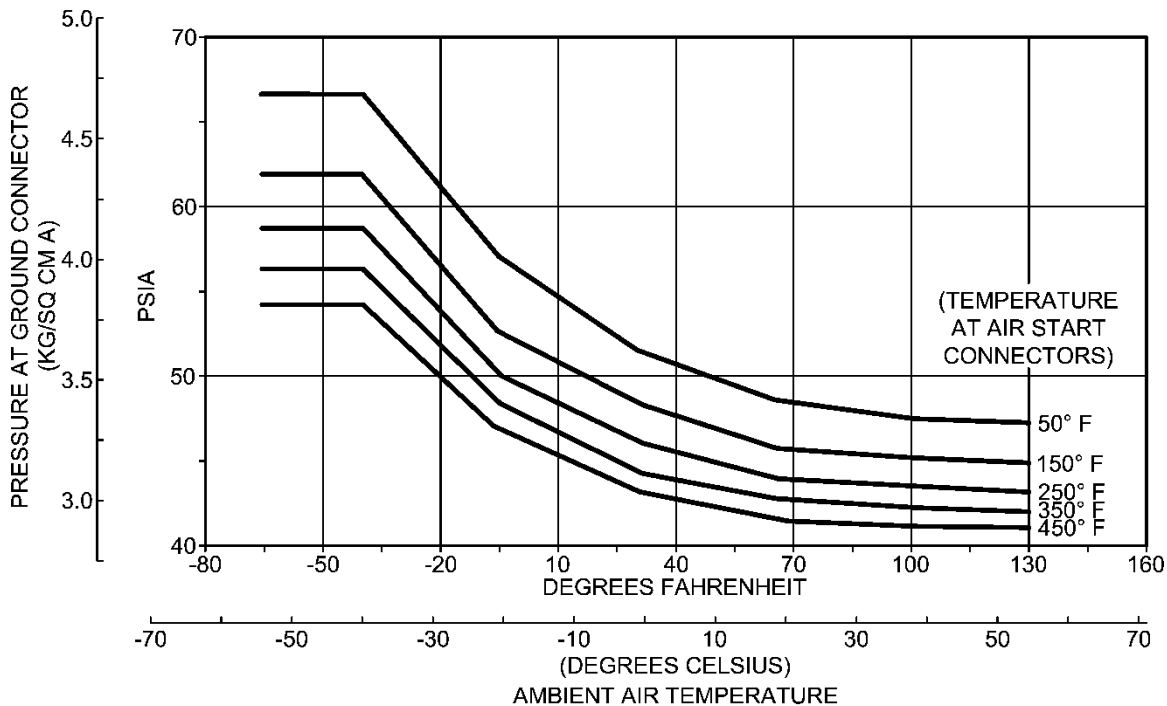
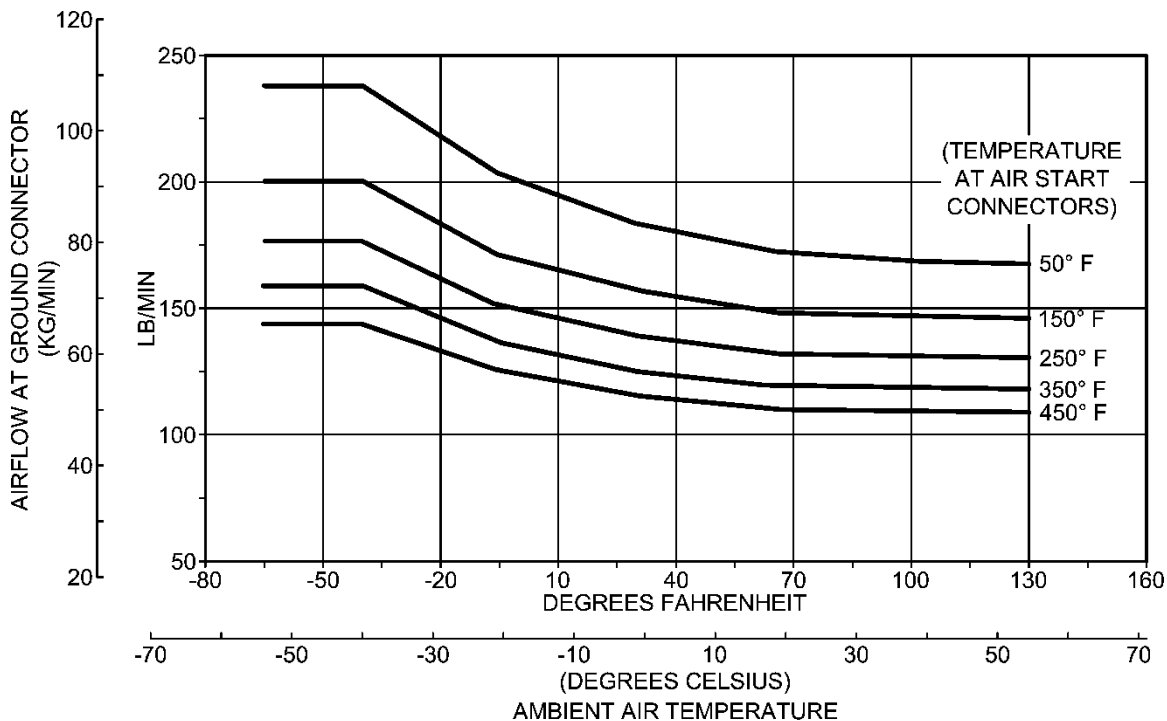

5.6 GROUND PNEUMATIC POWER REQUIREMENTS

5.6.1 Ground Pneumatic Power Requirements - Heating/Cooling: All Models

HEATING (PULL-UP)

- INITIAL CABIN TEMPERATURE: 0° F (-17.8° C)
- OUTSIDE AIR TEMPERATURE: 0° F (-17.8° C)
- NO GALLEY LOAD; NO ELECTRICAL LOAD

- $W_{CART} = 1.14 \times W$
- P = PRESSURE AT GROUND CONNECTION, PSIG
- TEMPERATURE AT GROUND CONNECTION: 200° F (93° C) TO 450° F (232° C)

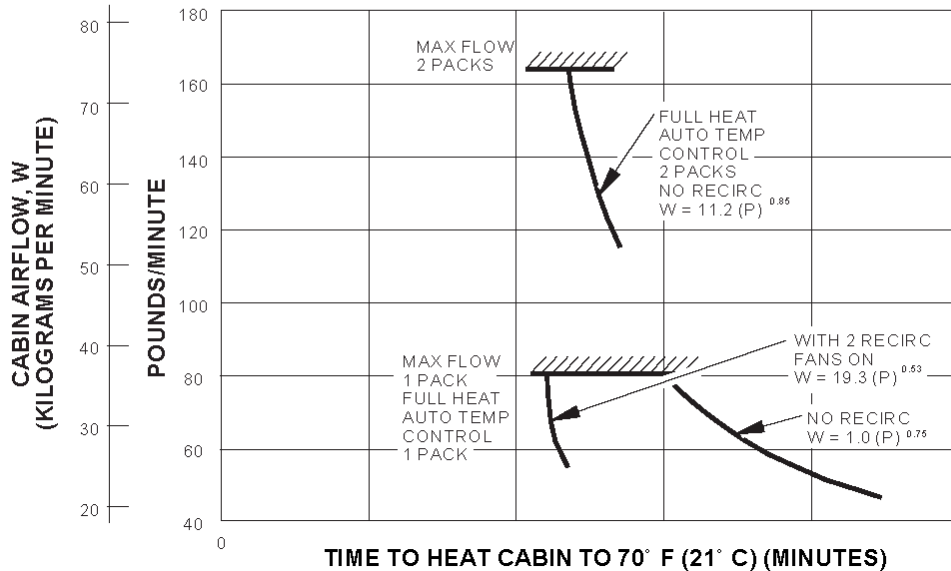

COOLING (PULL-DOWN)

- INITIAL CABIN TEMPERATURE: 103° F (39.5° C)
- OUTSIDE AIR TEMPERATURE: 103° F (39.5° C)
- SOLAR LOAD: 7,741 BTU/HR (195 KCAL/HR)

- NO GALLEY LOAD; NO ELECTRICAL LOAD
- TEMPERATURE AT GROUND CONNECTION: LESS THAN 450° F (232° C)

- $W_{CART} = 1.17 \times W$
- P = PRESSURE AT GROUND CONNECTION, PSIG

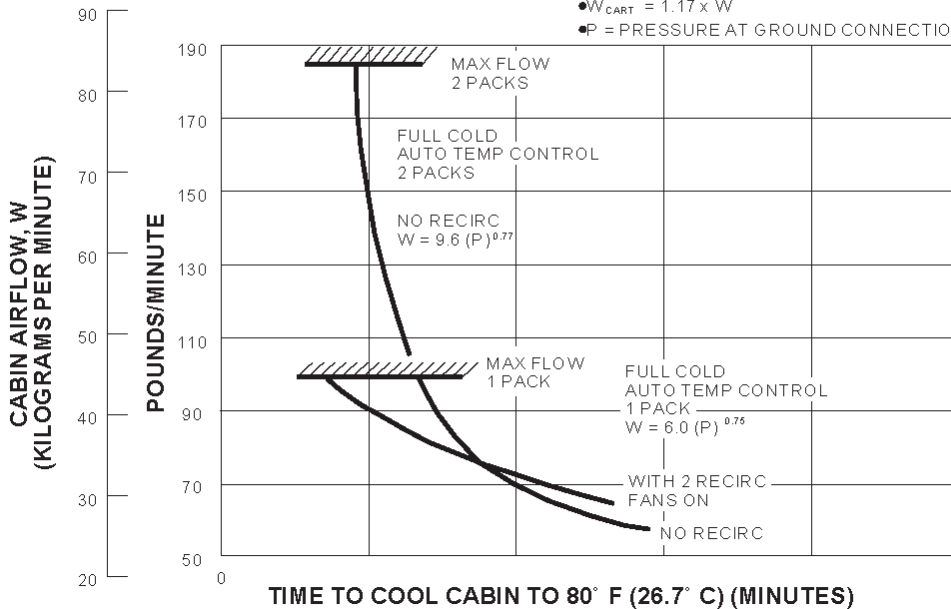

5.7 CONDITIONED AIR REQUIREMENTS

5.7.1 Conditioned Air Flow Requirements: All Models

COOLING:

- ① CABIN AT 75° F (23.9° C); 165 PASSENGERS AND CREW; NO GALLEY LOAD; SOLAR LOAD: 7,741 BTU/HR; ELECTRICAL LOAD: 10,955 BTU/HR
- ② CABIN AT 80° F (26.7° C); OTHERWISE SAME AS IN ①
- ③ CABIN AT 70° F (21.2° C); 2 CREW MEMBERS; GALLEY LOAD: 8,200 BTU/HR; SOLAR LOAD: 7,741 BTU/HR; ELECTRICAL LOAD: 10,955 BTU/HR
- ④ CABIN AT 80° F (26.7° C); 117 PASSENGERS AND CREW; NO GALLEY LOAD; BRIGHT DAY SOLAR LOAD: 7,741 BTU/HR; ELECTRICAL LOAD: 10,955 BTU/HR; PRECONDITIONED AIR PLANE

HEATING:

- ⑤ } CABIN AT 75° F (23.9° C); NO CREW OR PASSENGERS; NO OTHER HEAT LOAD
- ⑥ } CABIN AT 75° F (23.9° C); NO CREW OR PASSENGERS; NO OTHER HEAT LOAD
- ⑦ } CABIN AT 75° F (23.9° C); NO CREW OR PASSENGERS; NO OTHER HEAT LOAD
- ⑧ CABIN AT 75° F (23.9° C); 117 PASSENGERS AND CREW; NO GALLEY LOAD; ELECTRICAL LOAD: 10,955 BTU/HR; NO SOLAR LOAD.

ΔP_s = GAGE STATIC PRESSURE IN INCHES OF WATER AT GROUND CONNECTION
 1 BTU/UH = 0.252 KG-CAL/HR

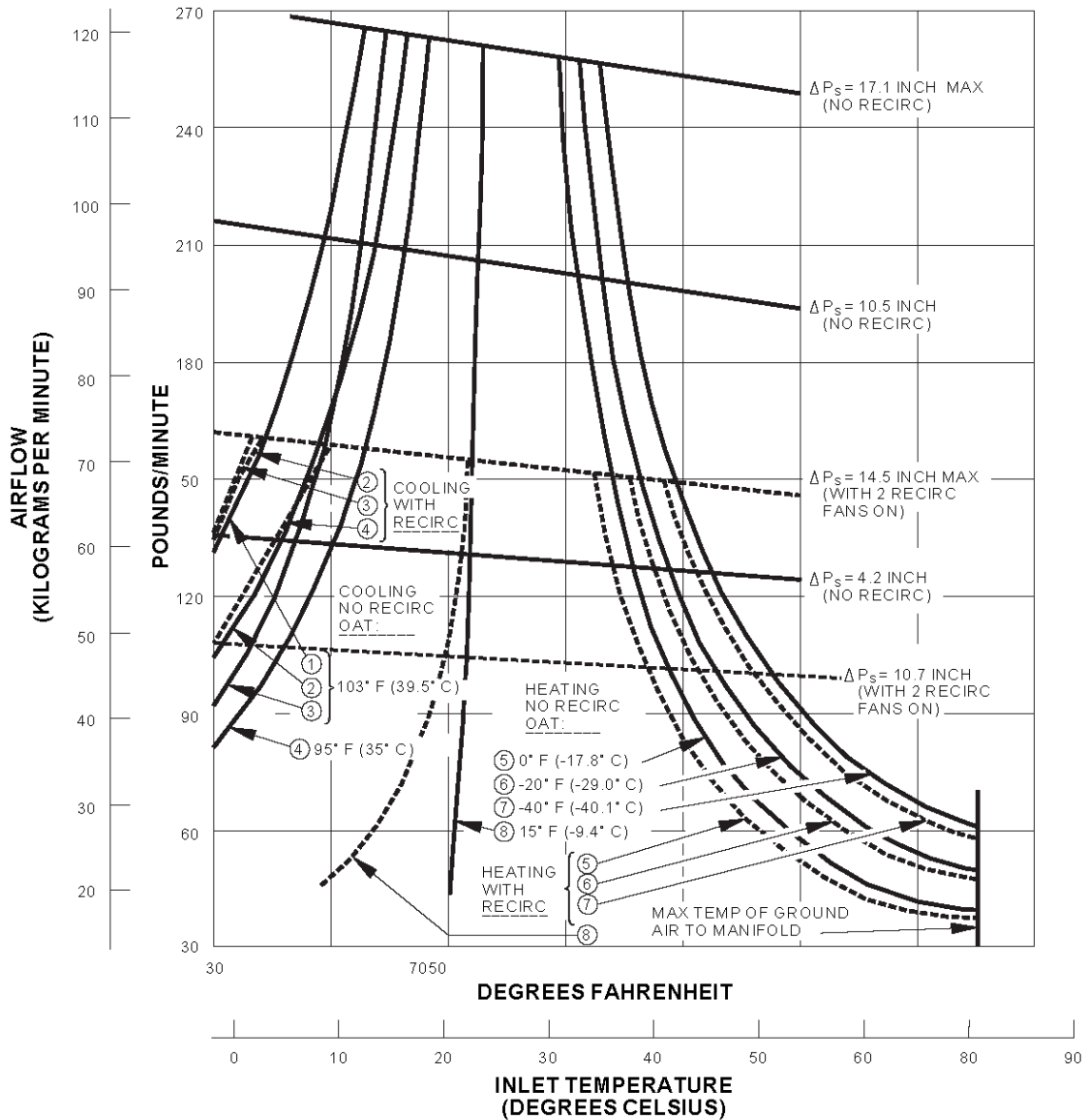

D6-38A004

5.8 GROUND TOWING REQUIREMENTS

5.8.1 Ground Towing Requirements - English Units: All Models

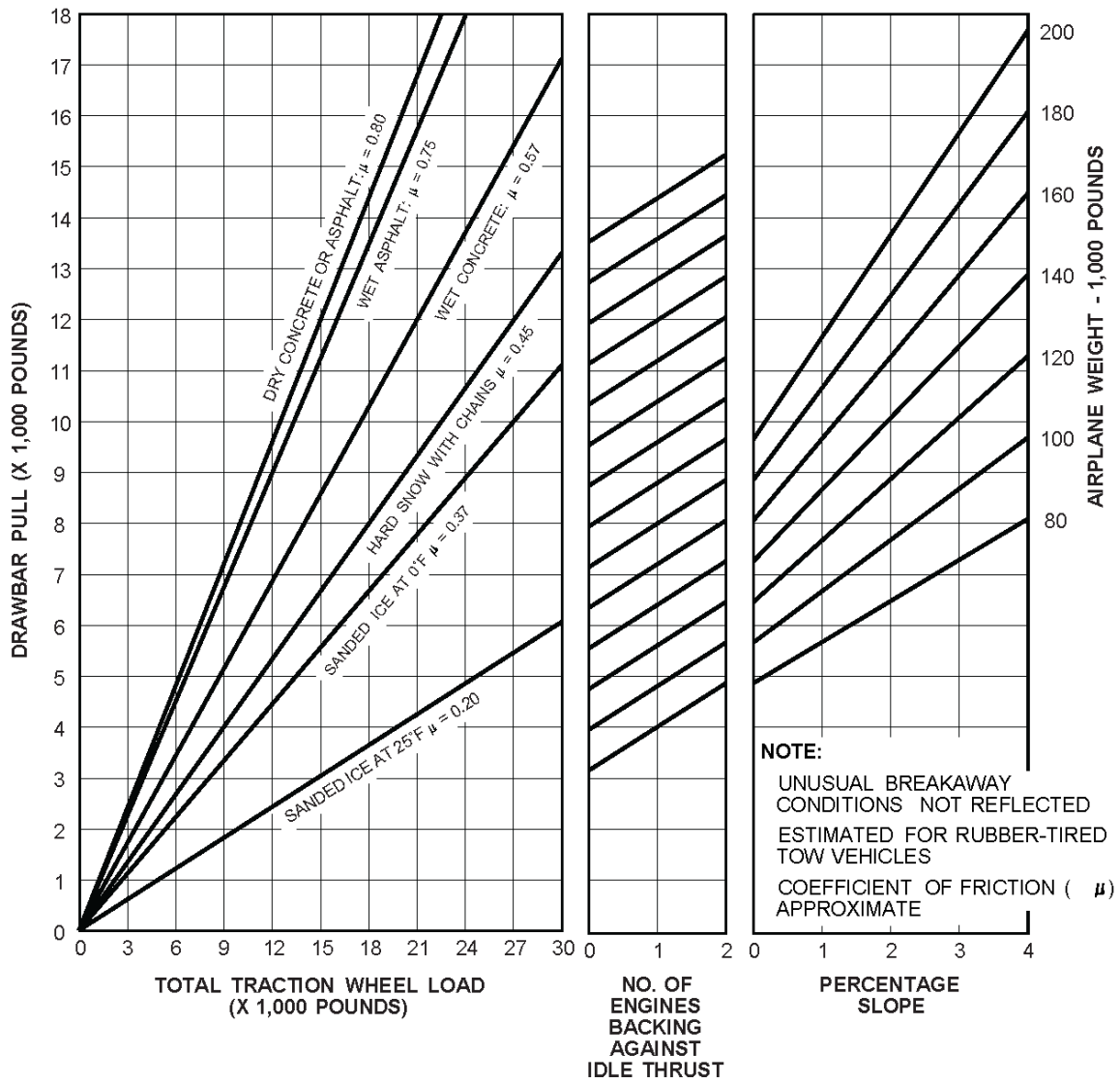

D6-38A004

5.8.2 Ground Towing Requirements - Metric Units: All Models

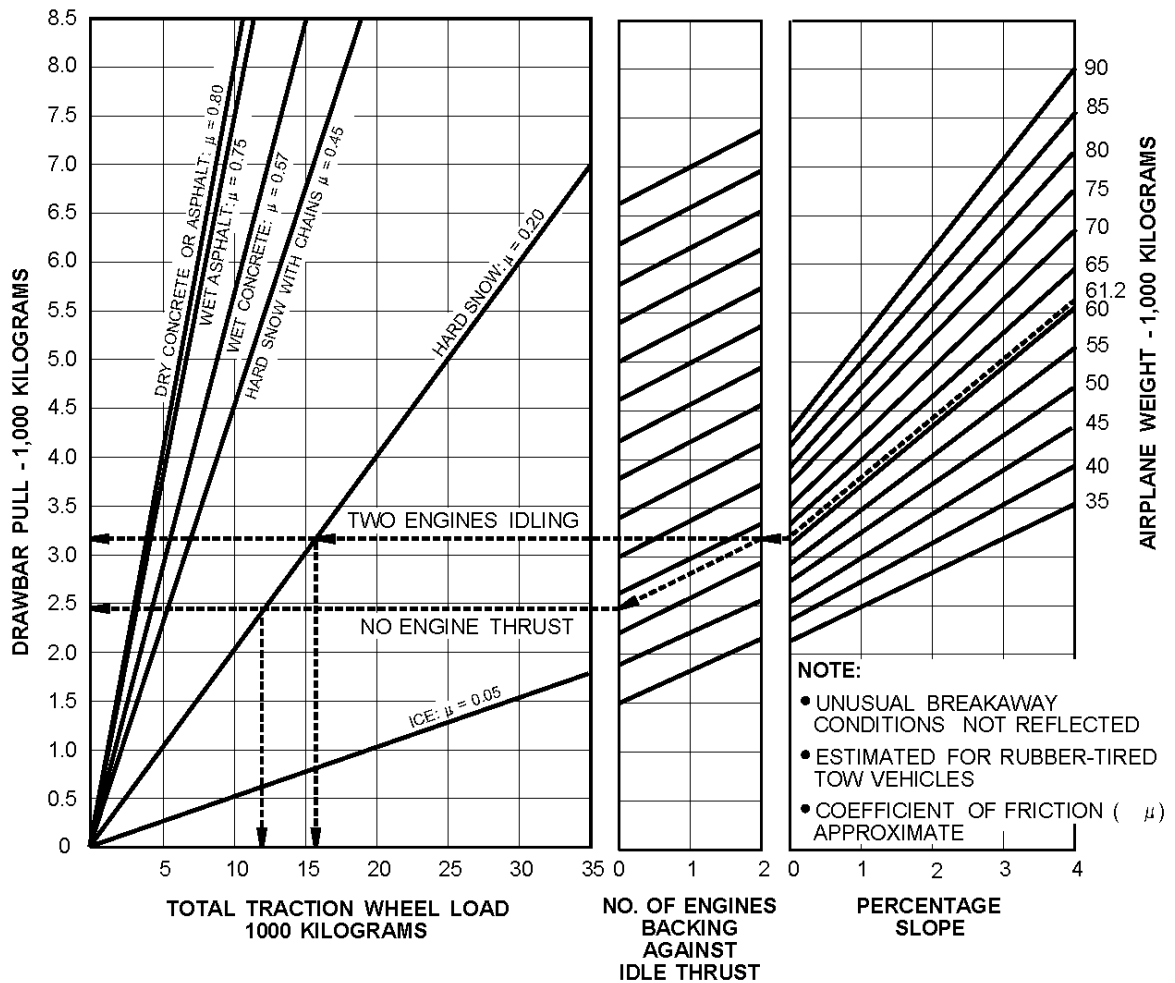

D6-38A004

6.0 JET ENGINE WAKE AND NOISE DATA

6.1 JET ENGINE EXHAUST VELOCITIES AND TEMPERATURES

This section shows jet engine exhaust velocity and temperature contours aft of the 737 MAX family of airplanes. The contours were calculated from a standard computer analysis using three-dimensional viscous flow equations with mixing of primary, fan, and free-stream flow. The presence of the ground plane is included in the calculations as well as engine tilt and toe-in. Mixing of flows from the engines is also calculated. The analysis does not include thermal buoyancy effects which tend to elevate the jet wake above the ground plane. The buoyancy effects are considered to be small relative to the exhaust velocity and therefore are not included.

The graphs show jet wake velocity and temperature contours for representative engines. The results are valid for sea level, static, standard day conditions. The effect of wind on jet wakes is not included. There is evidence to show that a downwind or an upwind component does not simply add or subtract from the jet wake velocity, but rather carries the whole envelope in the direction of the wind. Crosswinds may carry the jet wake contour far to the side at large distances behind the airplane.

It should be understood, these exhaust velocity contours reflect steady-state, at maximum taxi weight, and not transient-state exhaust velocities. A steady-state is achieved with the aircraft in a fixed location, engine running at a given thrust level and measured when the contours stop expanding and stabilize in size, which could take several seconds. The steady-state condition, therefore, is conservative. Contours shown also do not account for performance variables such as ambient temperature or field elevation. For the terminal area environment, the transient-state is a more accurate representation of the actual exhaust contours when the aircraft is in motion and encountering static air with forward or turning movement, but it is very difficult to model on a consistent basis due to aircraft weight, weather conditions, the high degree of variability in terminal and apron configurations, and intensive numerical calculations. If the contours presented here are overly restrictive for terminal operations, The Boeing Company recommends conducting an analysis of the actual exhaust contours experienced by the using aircraft at the airport.

6.1.1 Jet Engine Exhaust Velocity Contours - Idle Thrust: All Models

- NOTES:
- ENGINE THRUST AT IDLE SETTING
 - CONTOURS CALCULATED FROM COMPUTER DATA
 - STANDARD DAY
 - SEA LEVEL
 - NO WIND
 - 0% SLOPE
 - BOTH ENGINES RUNNING
 - 1,141 LBF/ENGINE

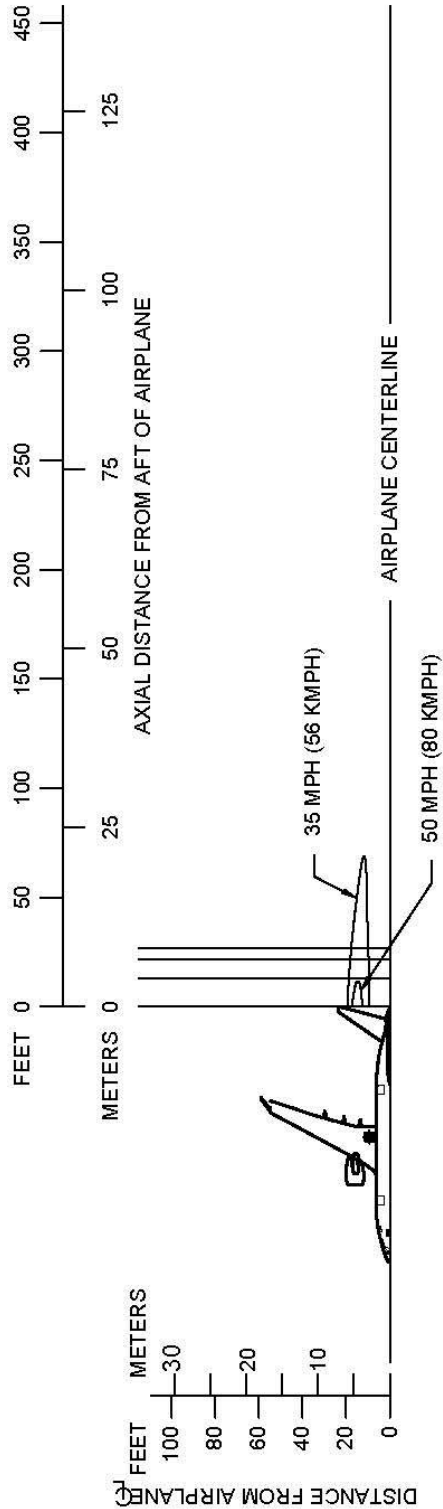
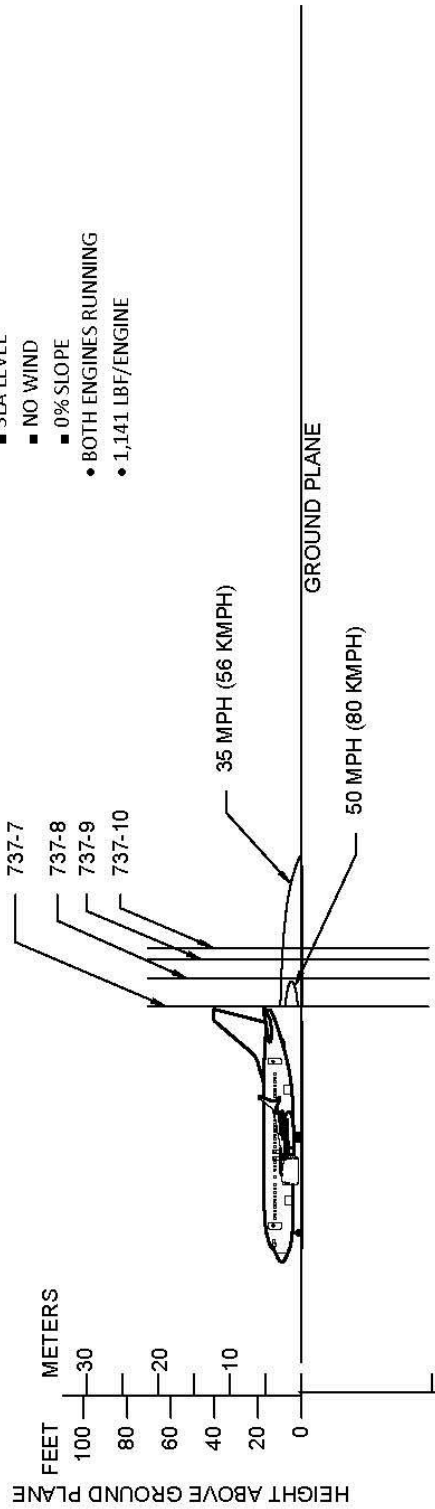

D6-38A004

6.1.2 Jet Engine Exhaust Velocity Contours - Breakaway Thrust / 0% Slope / One Engine / MLW: Model 737-7

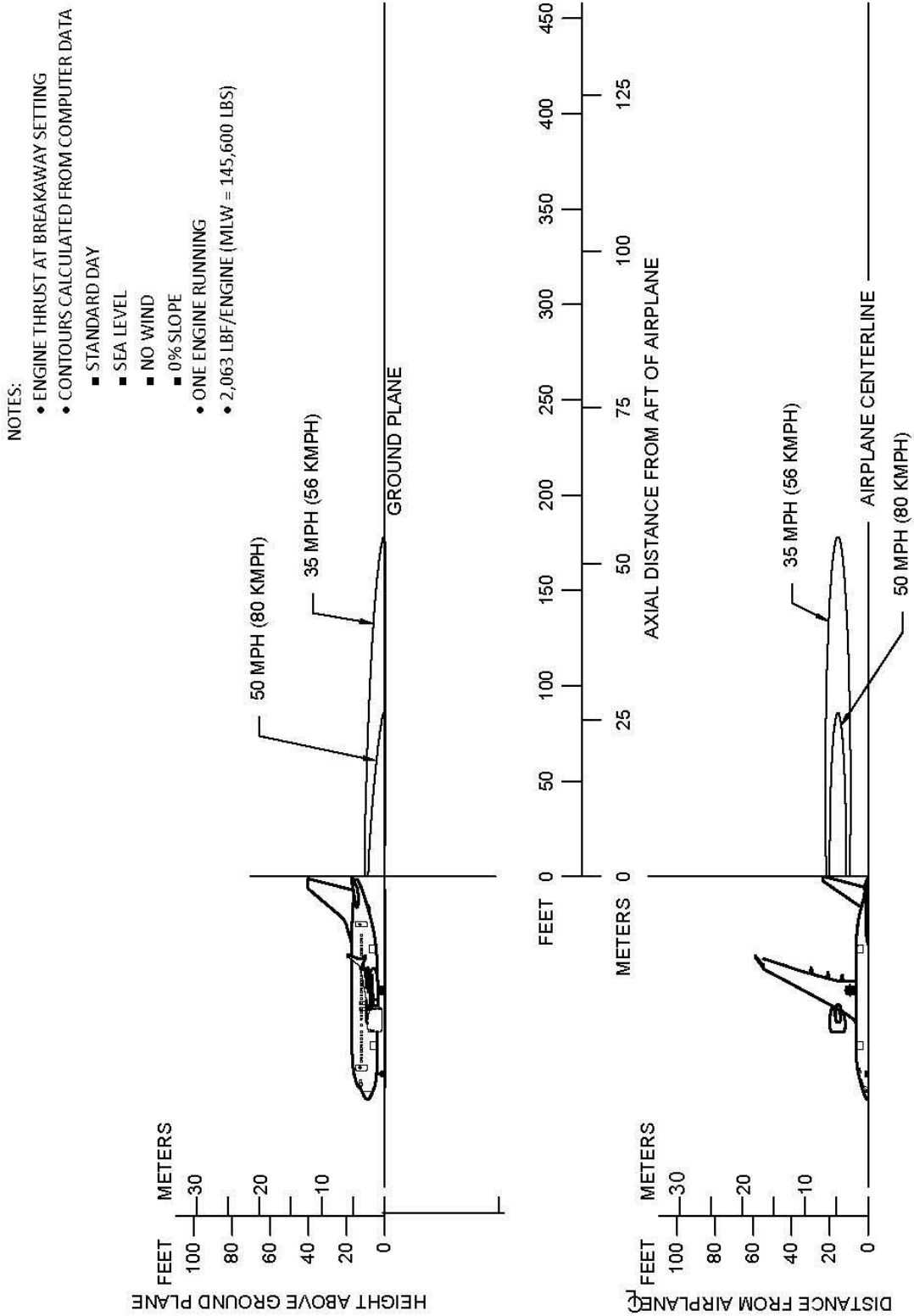

D6-38A004

6.1.3 Jet Engine Exhaust Velocity Contours - Breakaway Thrust / 0% Slope / One Engine / MTW: Model 737-7

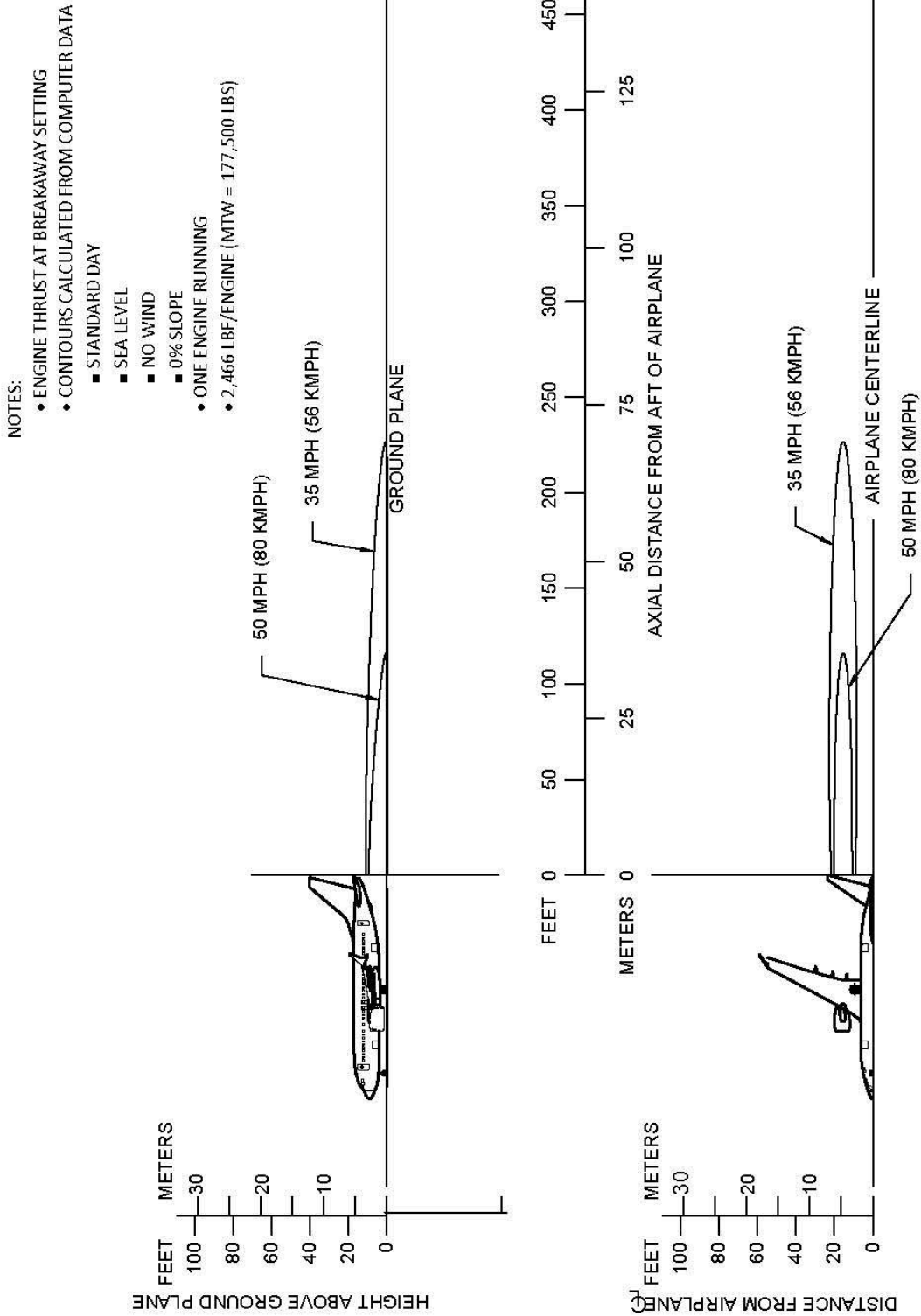

6.1.4 Jet Engine Exhaust Velocity Contours - Breakaway Thrust / 0% Slope / Both Engines / MTW: Model 737-7

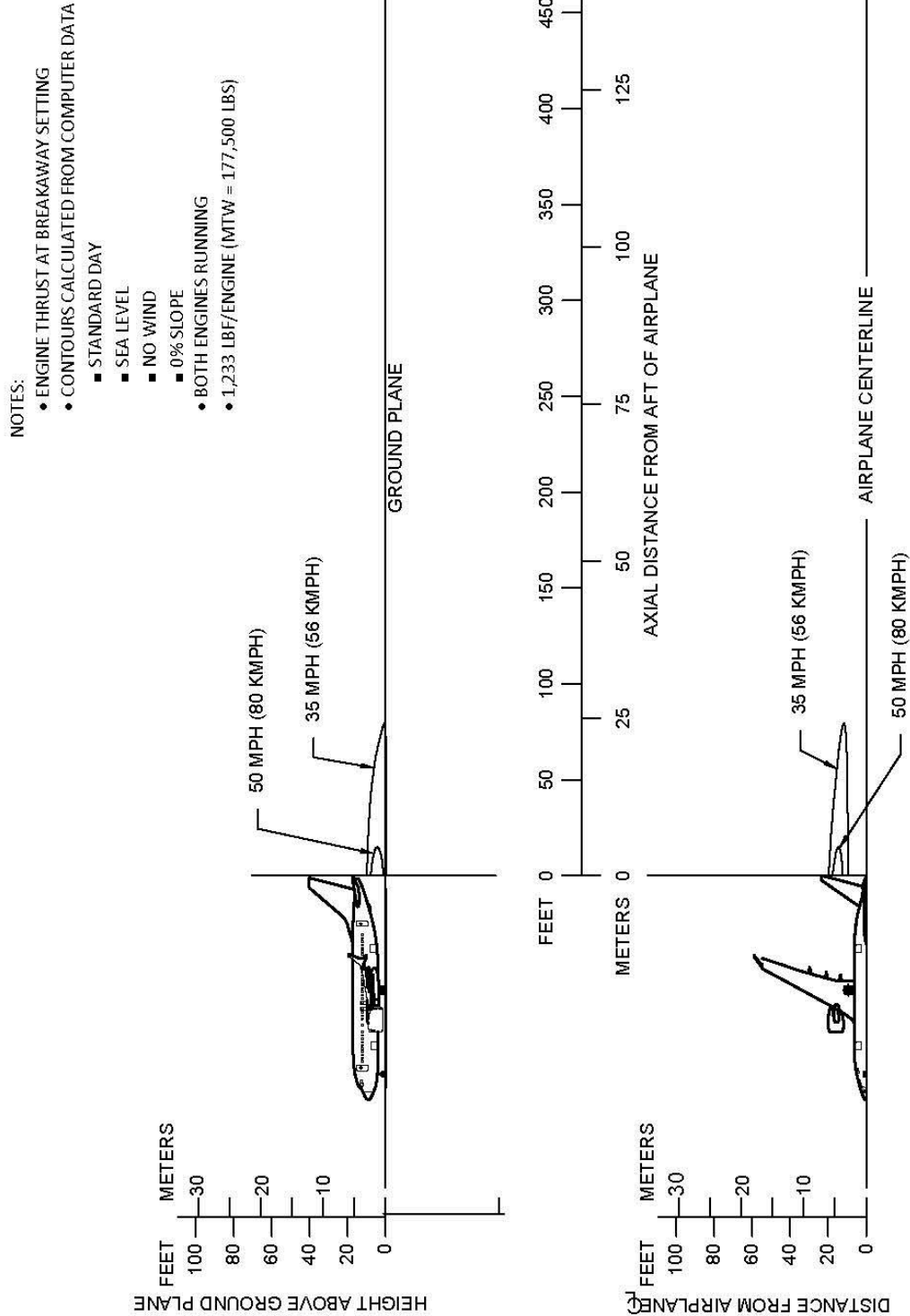

D6-38A004

6.1.5 Jet Engine Exhaust Velocity Contours - Breakaway Thrust / 1% Slope / Both Engines / MTW: Model 737-7

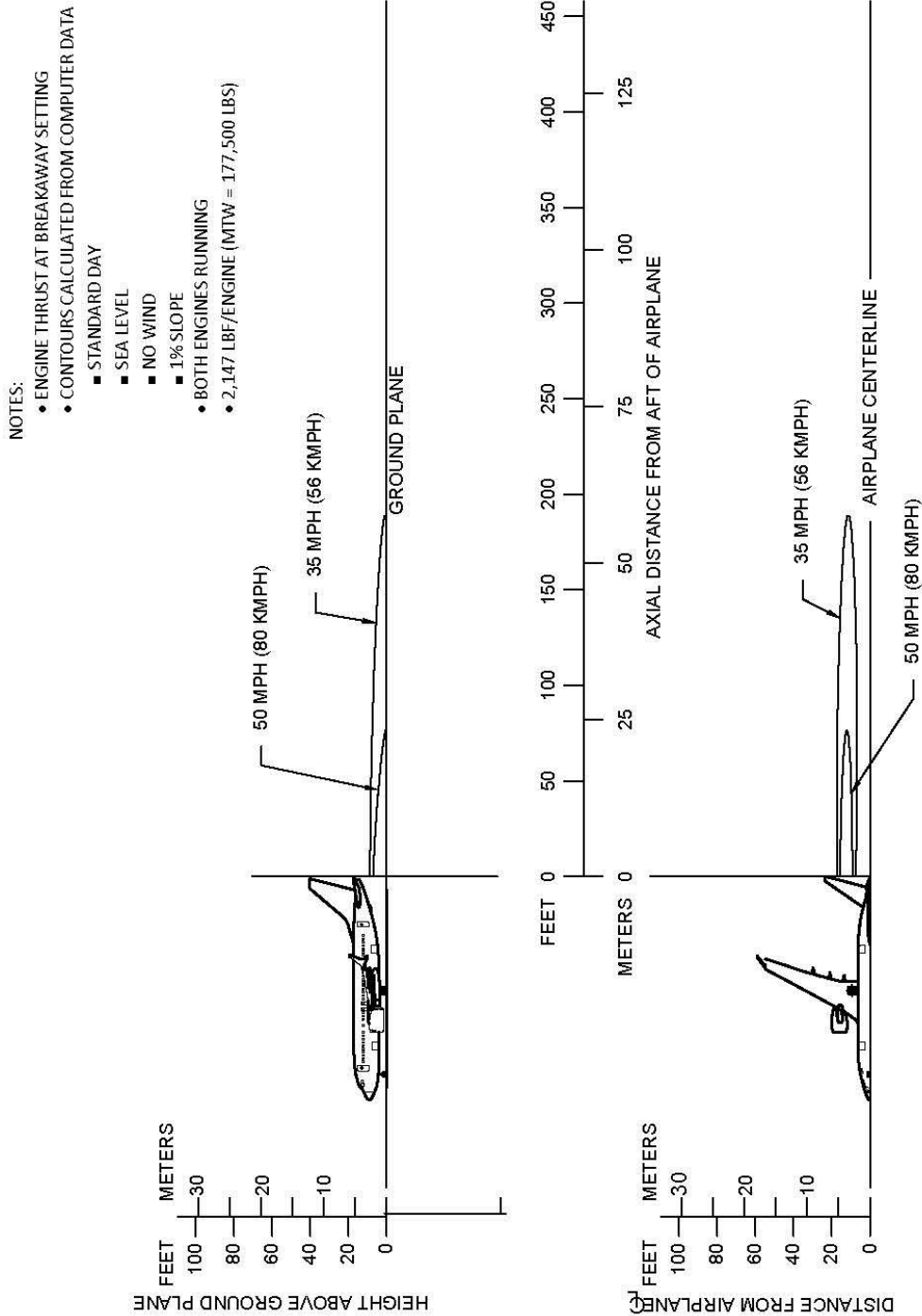

D6-38A004

6.1.6 Jet Engine Exhaust Velocity Contours - Breakaway Thrust / 0% Slope / One Engine / MLW: Model 737-8 / -8-200 / BBJ MAX 8

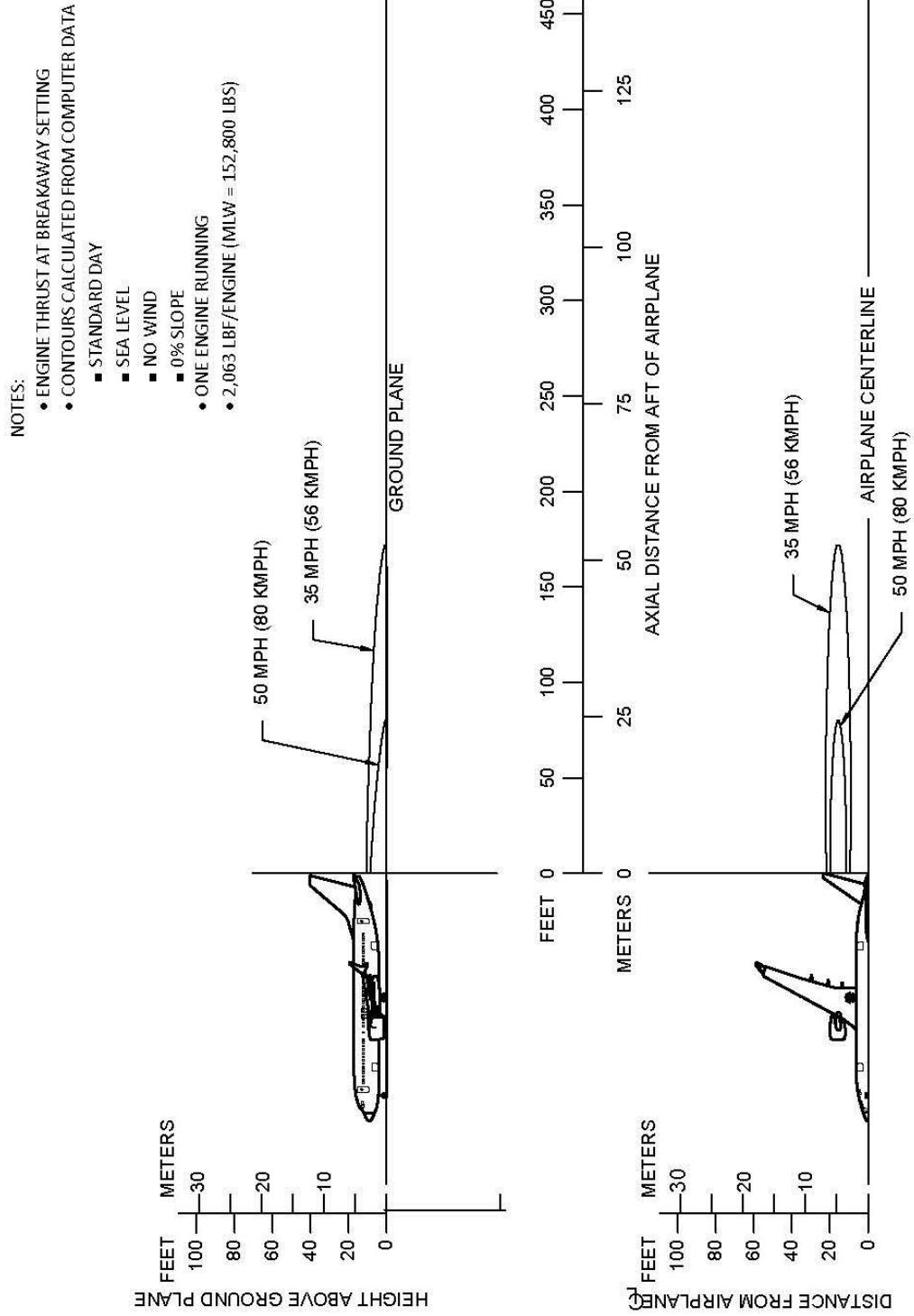

6.1.7 Jet Engine Exhaust Velocity Contours - Breakaway Thrust / 0% Slope / One Engine / MTW: Model 737-8 / -8-200 / BBJ MAX 8

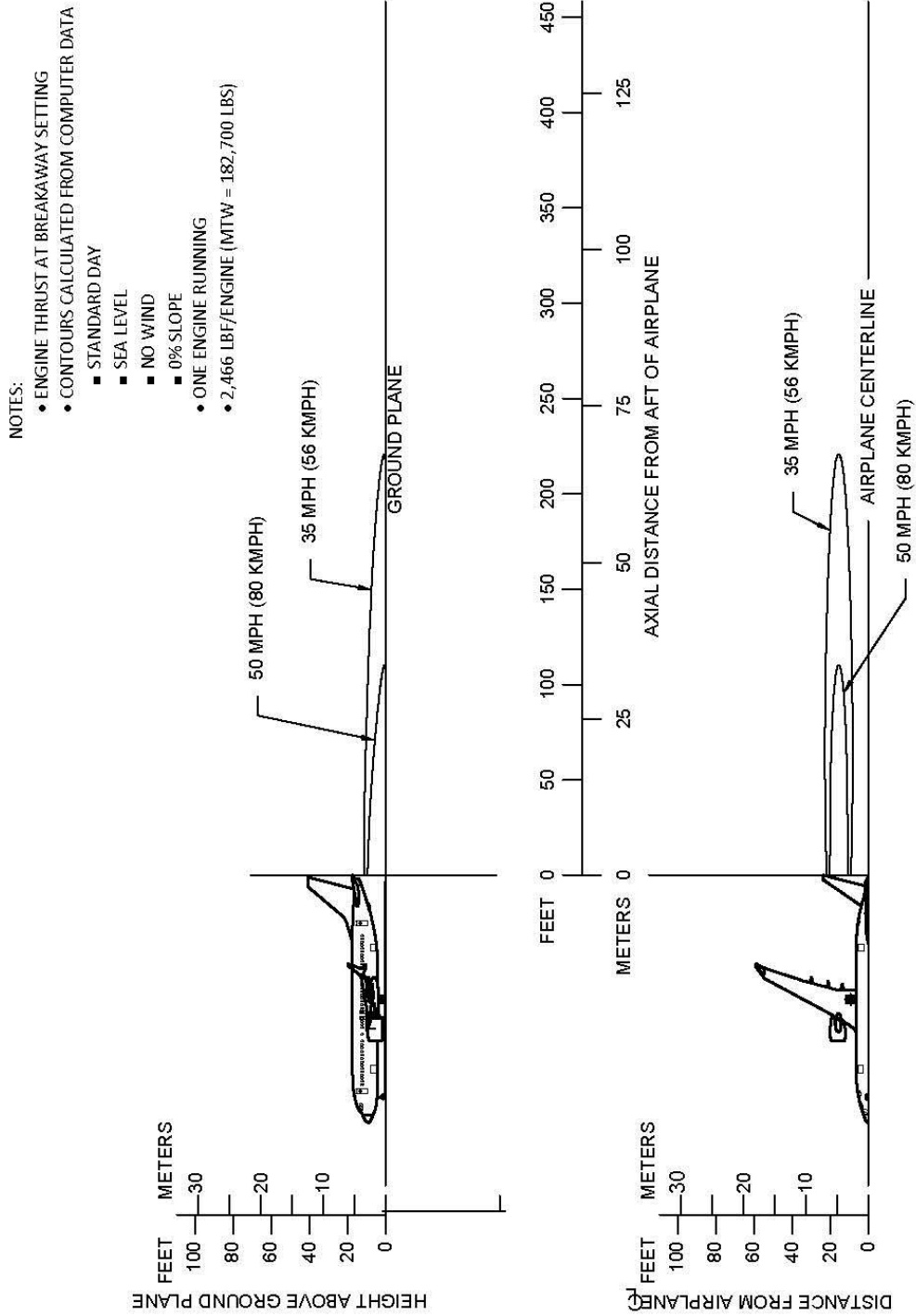

D6-38A004

6.1.8 Jet Engine Exhaust Velocity Contours - Breakaway Thrust / 0% Slope / Both Engines / MTW: Model 737-8 / -8-200 / BBJ MAX 8

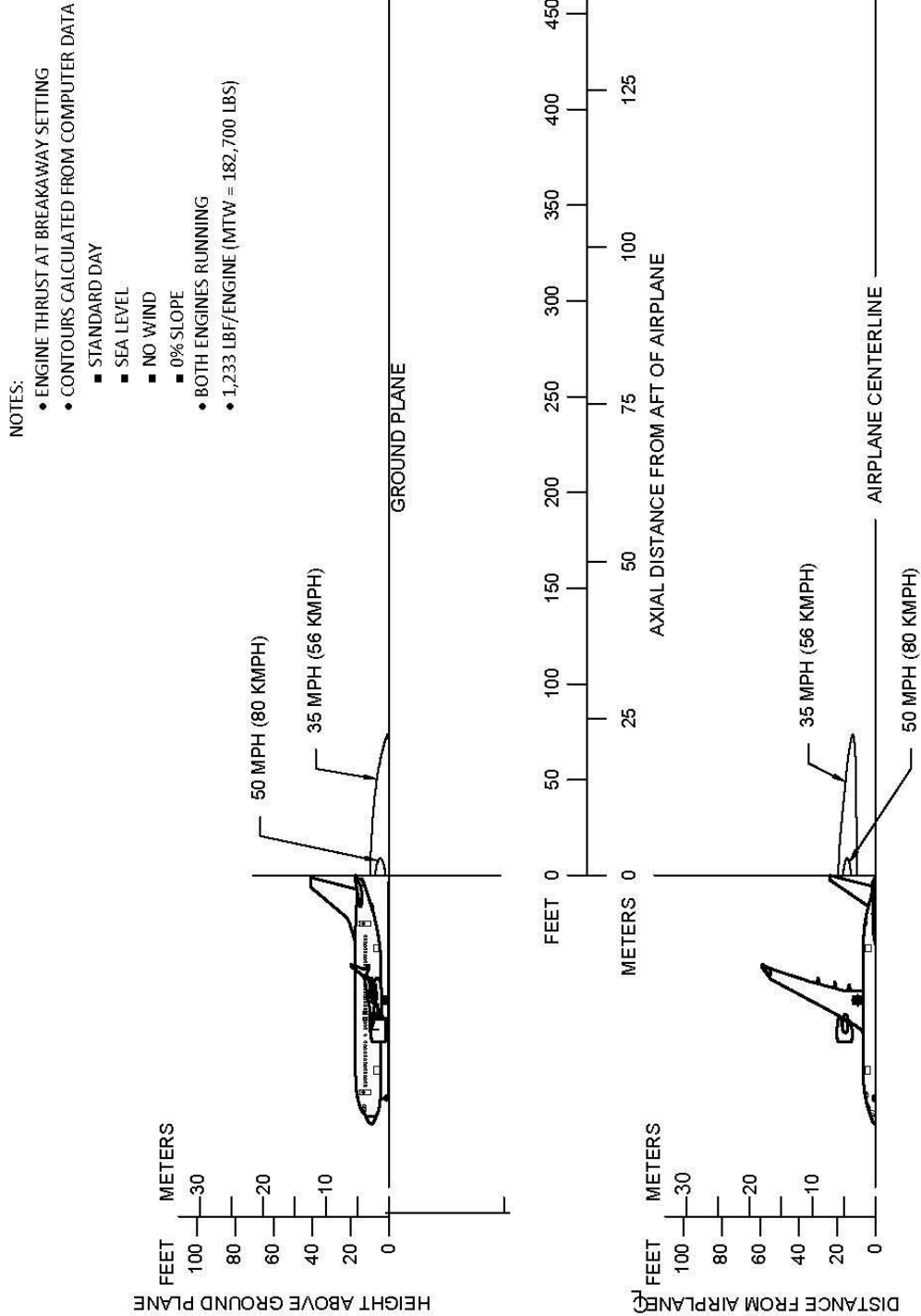

6.1.9 Jet Engine Exhaust Velocity Contours - Breakaway Thrust / 1% Slope / Both Engines / MTW: Model 737-8 / -8-200 / BBJ MAX 8

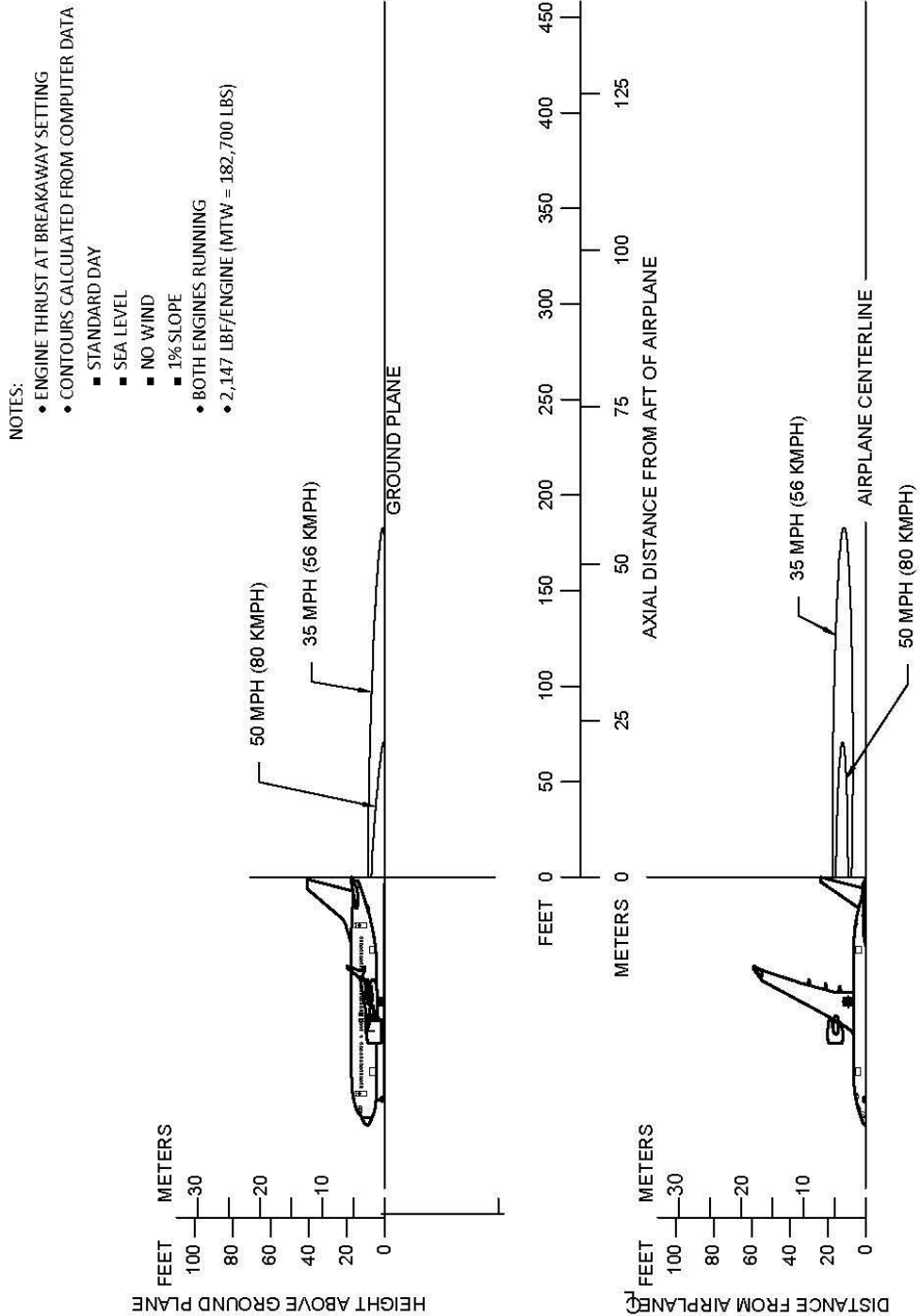

D6-38A004

6.1.10 Jet Engine Exhaust Velocity Contours - Breakaway Thrust / 0% Slope / One Engine / MTW: Model 737-9 / BBJ MAX 9

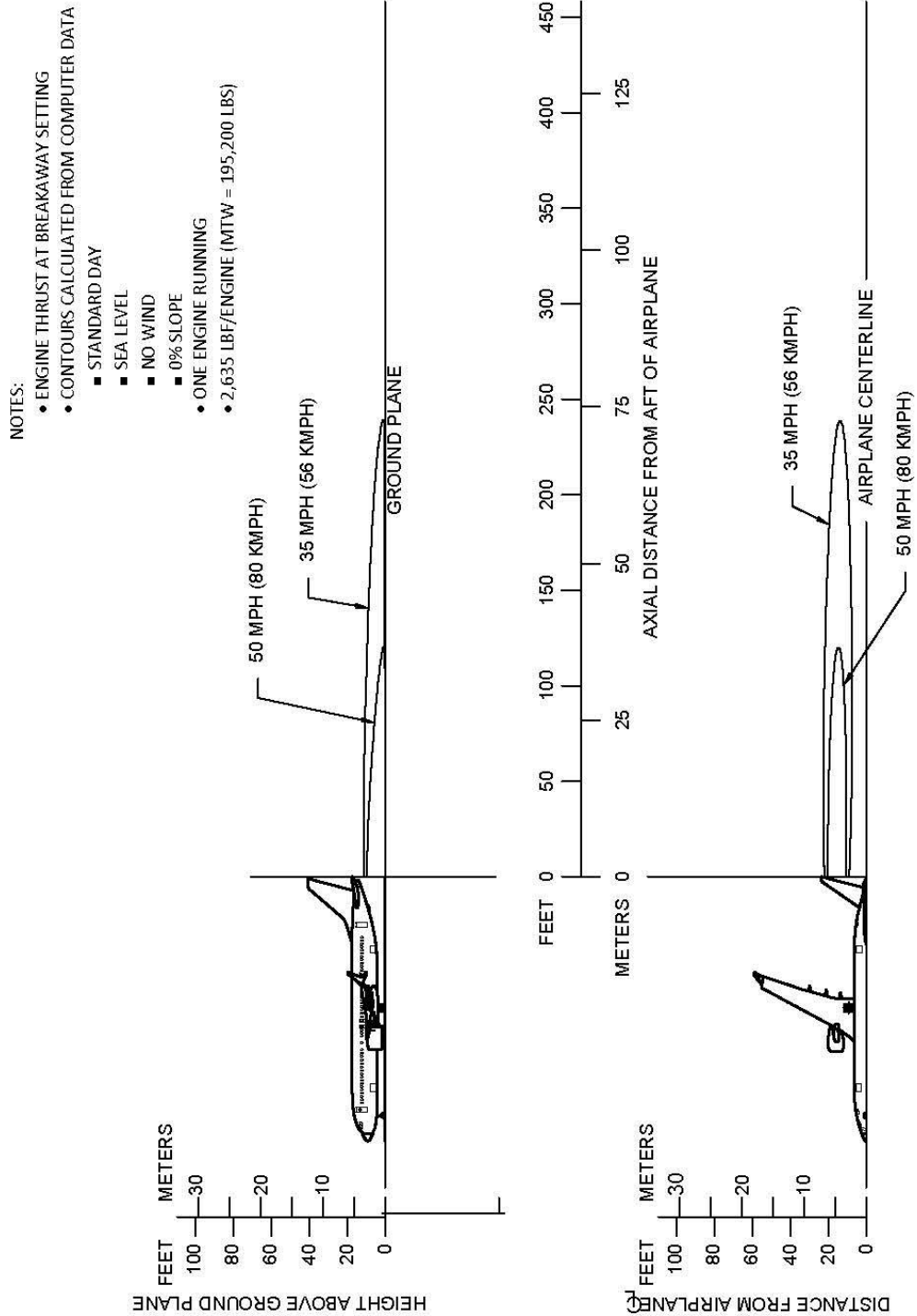

6.1.11 Jet Engine Exhaust Velocity Contours - Breakaway Thrust / 0% Slope / Both Engines / MLW: Model 737-9 / BBJ MAX 9

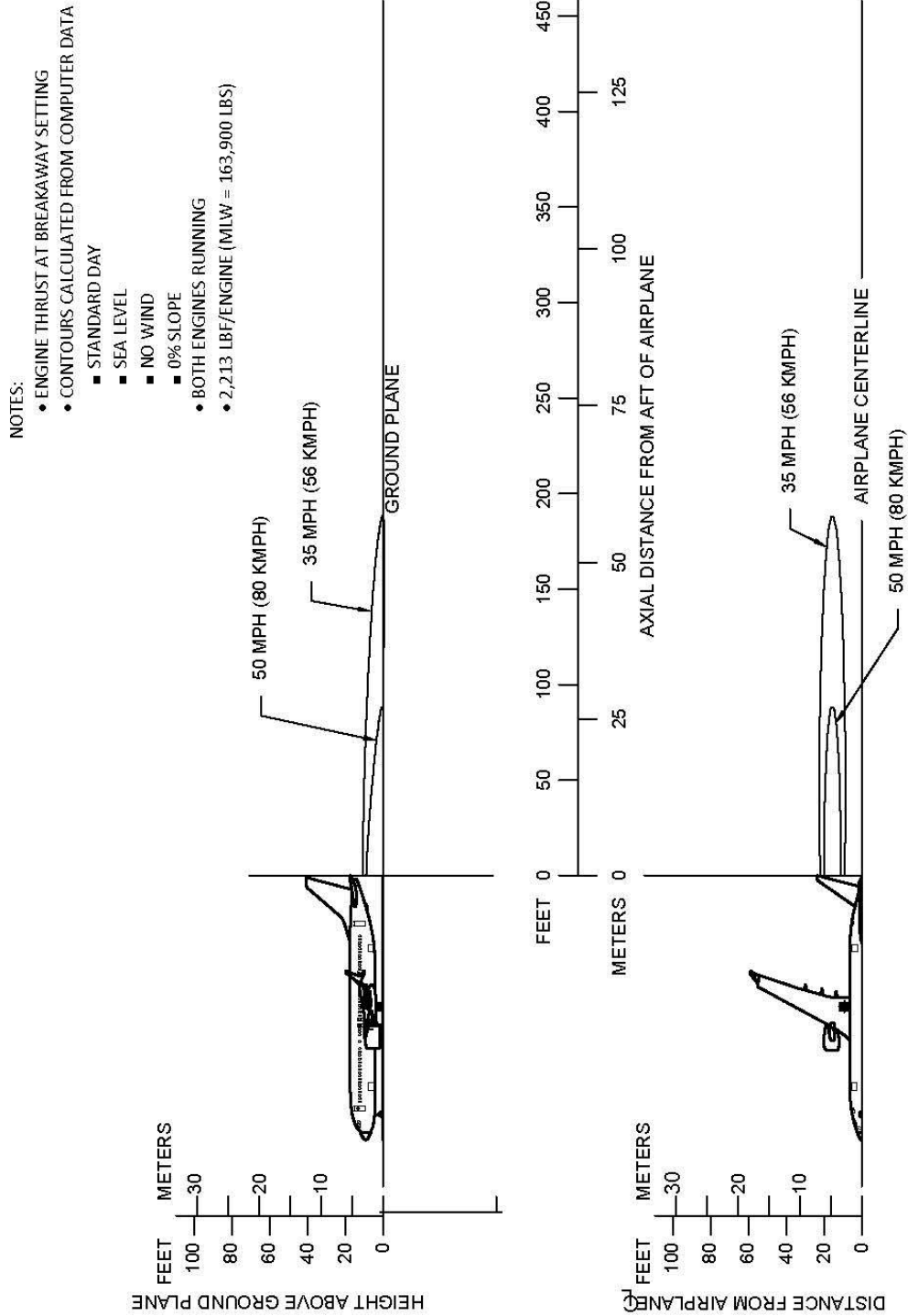

D6-38A004

6.1.12 Jet Engine Exhaust Velocity Contours - Breakaway Thrust / 0% Slope / Both Engines / MTW: Model 737-9 / BBJ MAX 9

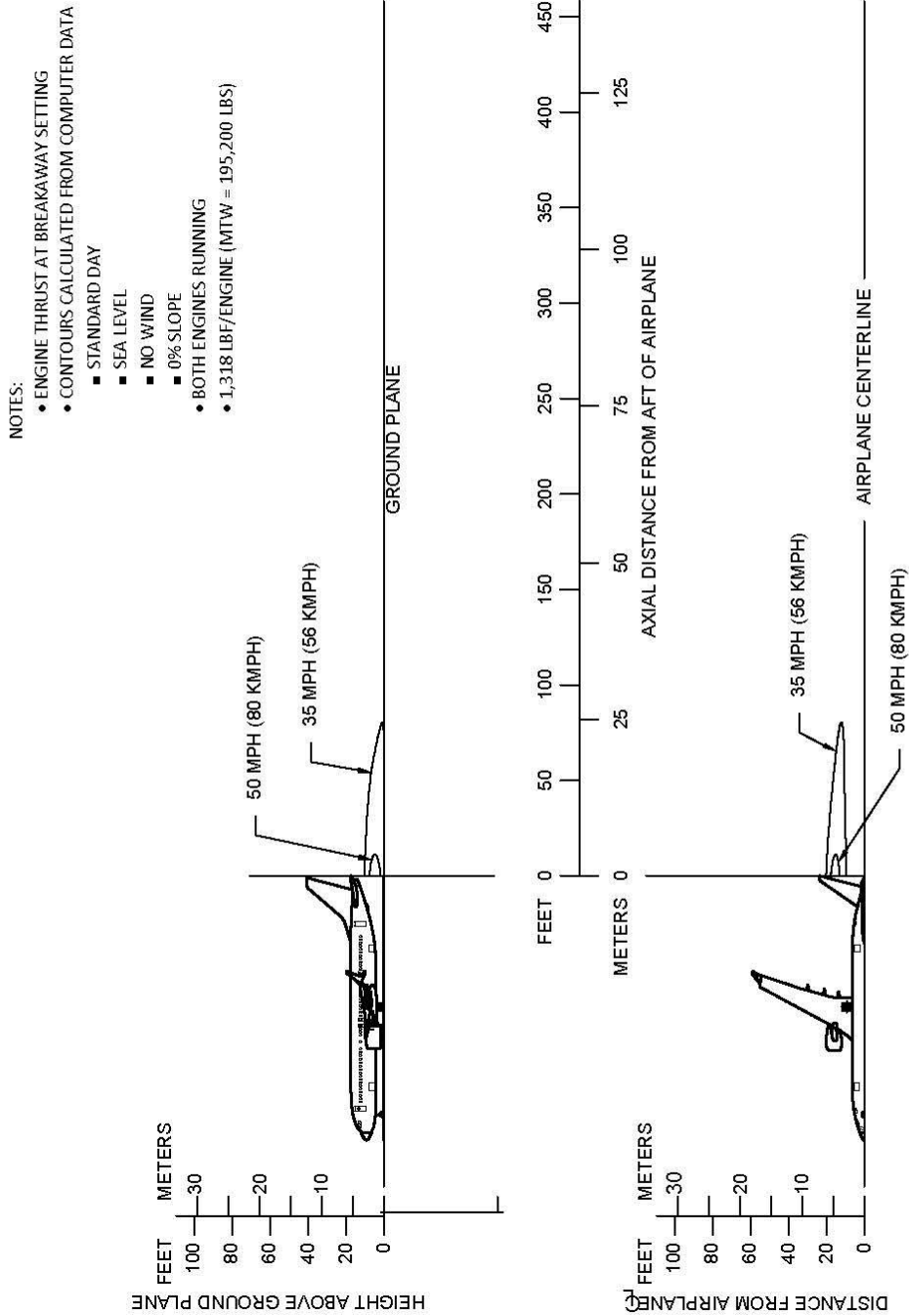

6.1.13 Jet Engine Exhaust Velocity Contours - Breakaway Thrust / 1% Slope / Both Engines / MTW: Model 737-9 / BBJ MAX 9

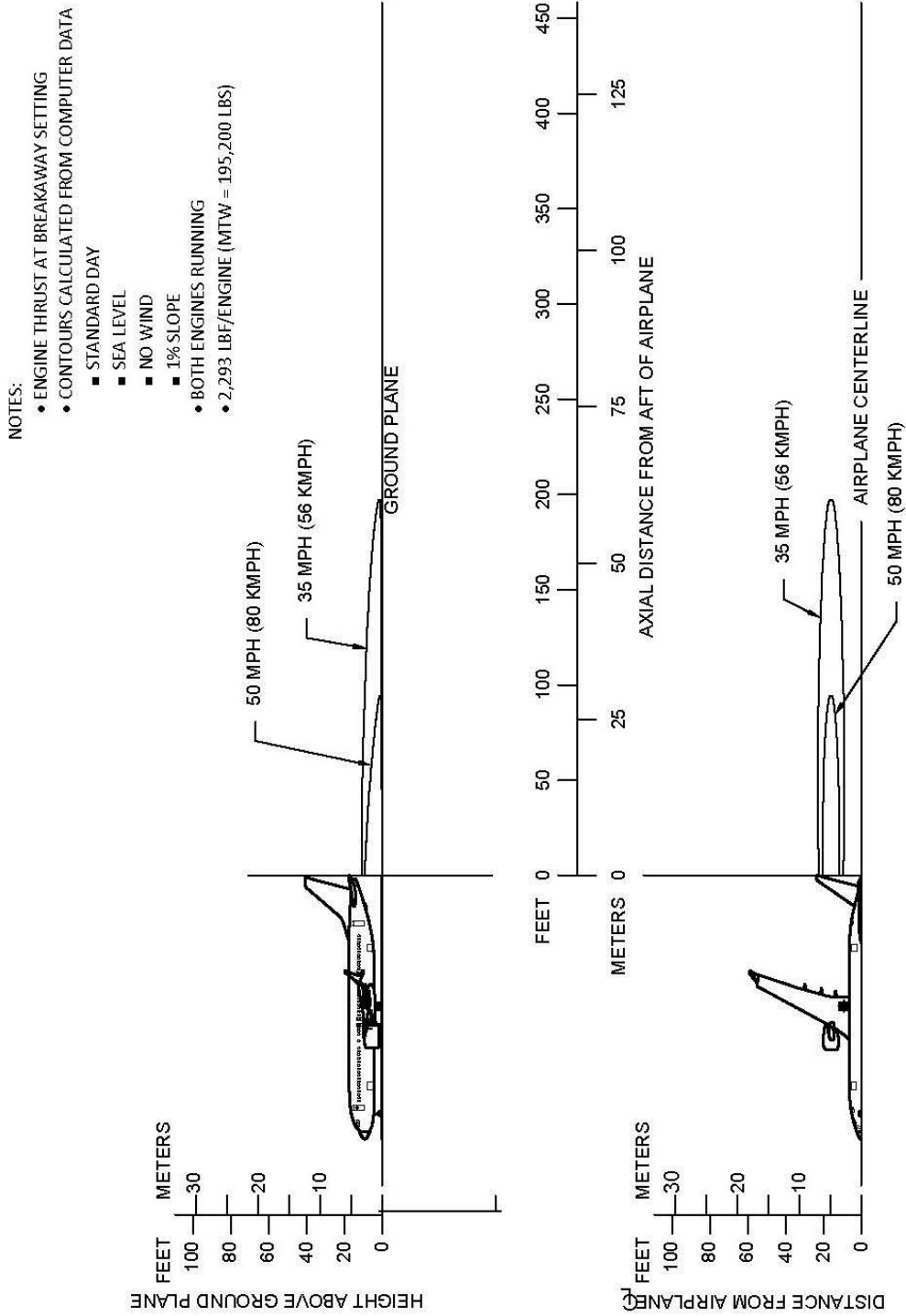

D6-38A004

6.1.14 Jet Engine Exhaust Velocity Contours – Breakaway Thrust / 0% Slope / One Engine / MLW: Model 737-10

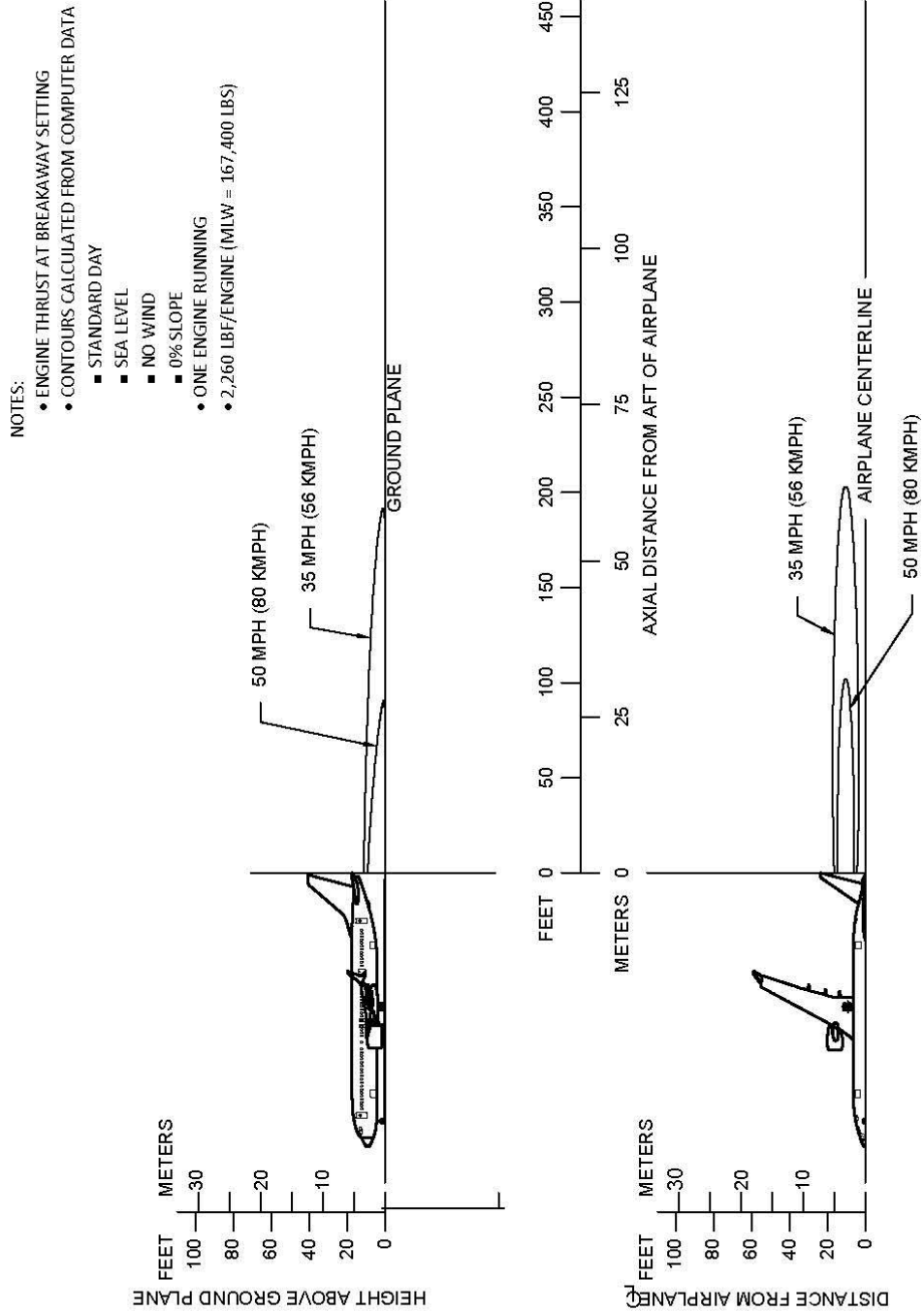

6.1.15 Jet Engine Exhaust Velocity Contours – Breakaway Thrust / 0% Slope / One Engine / MTW: Model 737-10

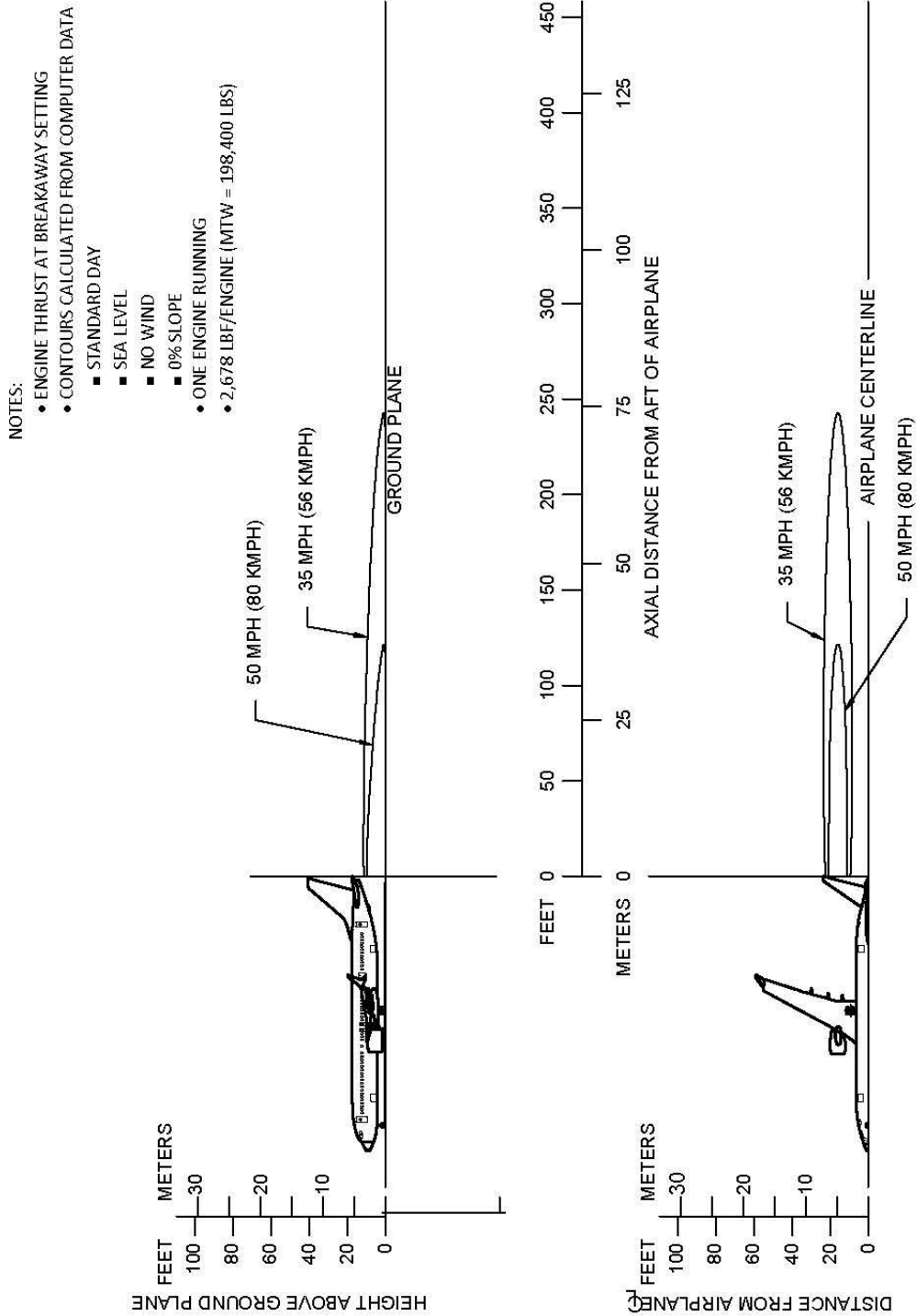

D6-38A004

6.1.16 Jet Engine Exhaust Velocity Contours – Breakaway Thrust / 0% Slope / Both Engines / MTW: Model 737-10

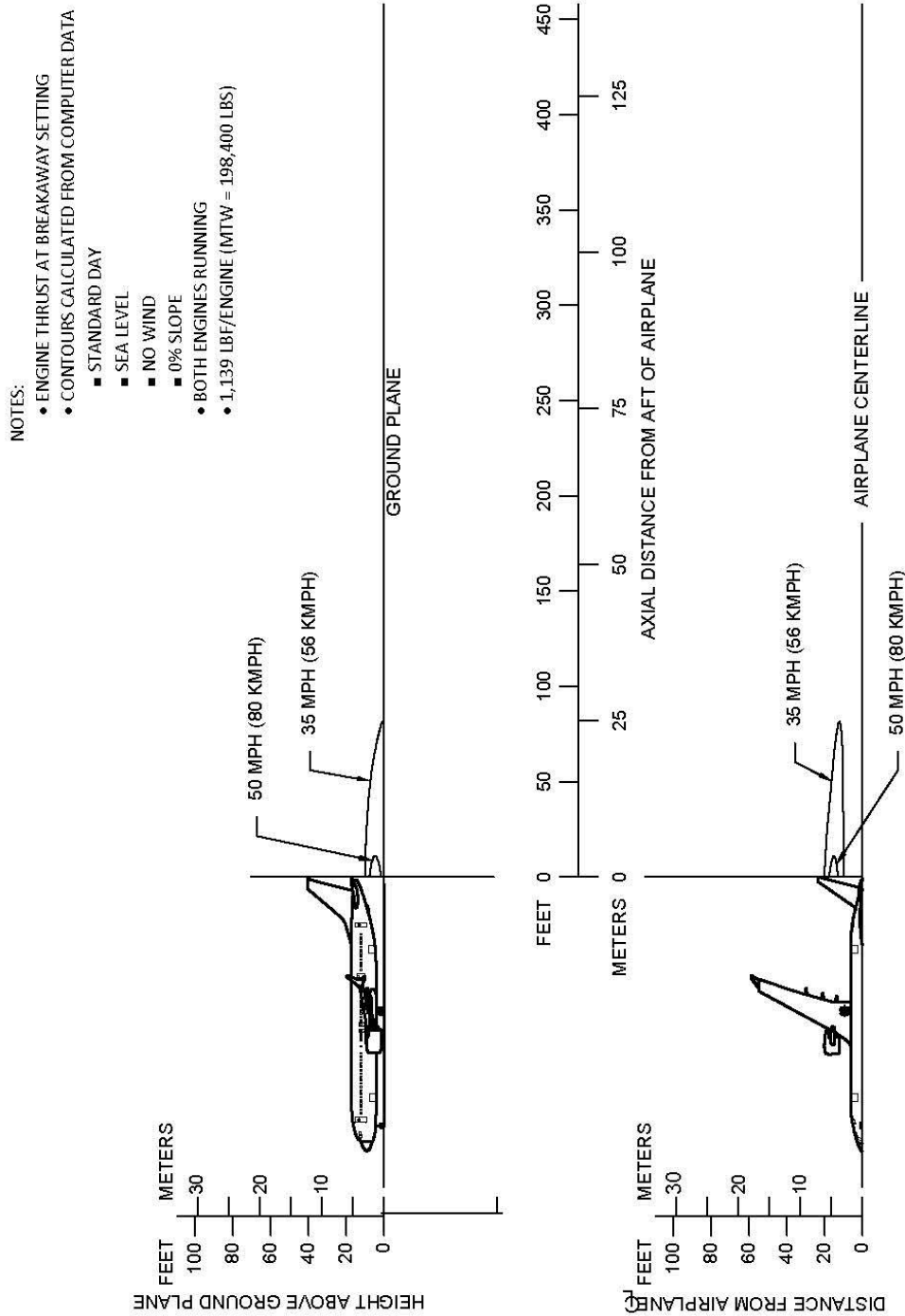

6.1.17 Jet Engine Exhaust Velocity Contours – Breakaway Thrust / 1% Slope / Both Engines / MTW: Model 737-10

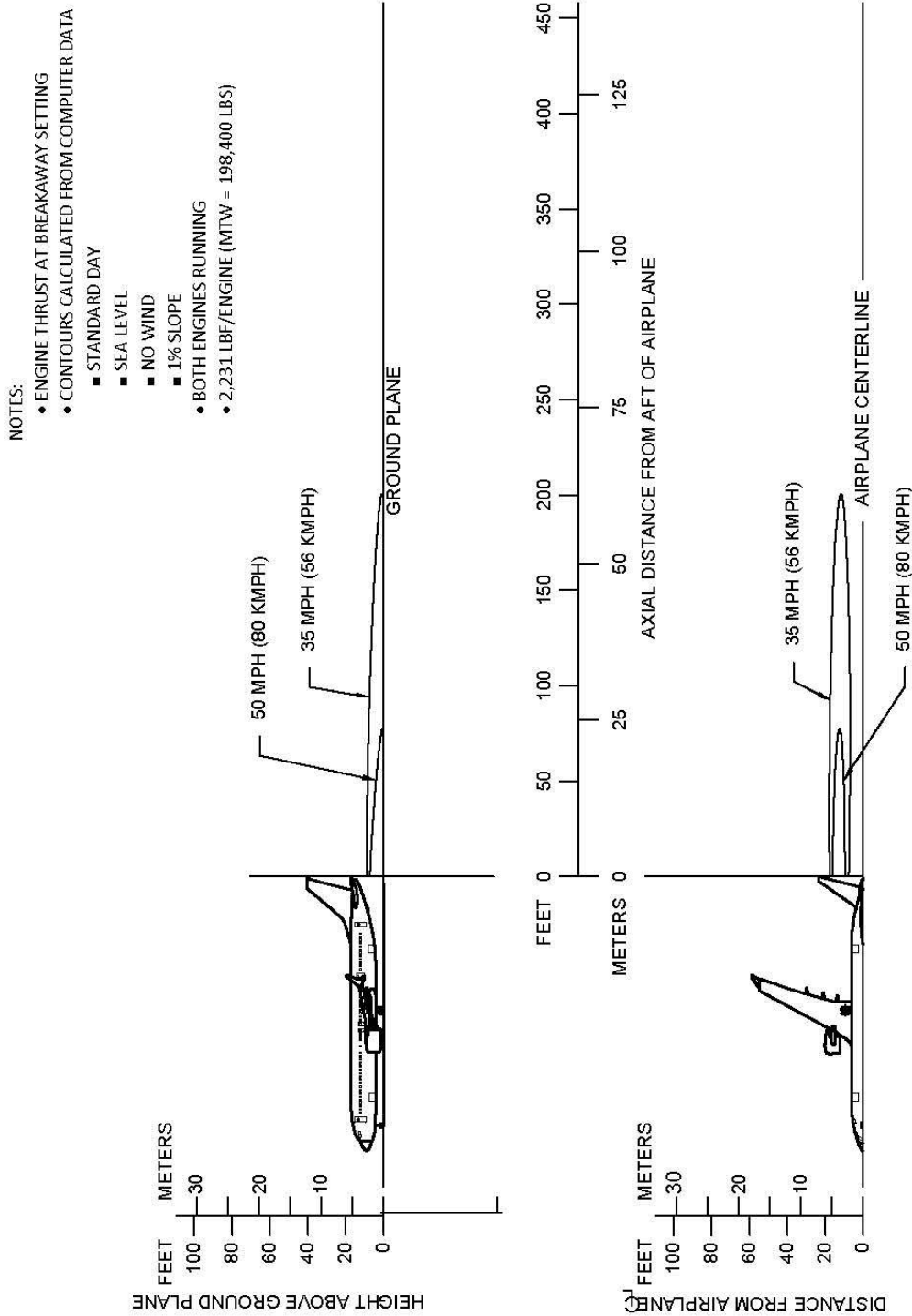

D6-38A004

6.1.18 Jet Engine Exhaust Velocity Contours – Takeoff Thrust: All Models

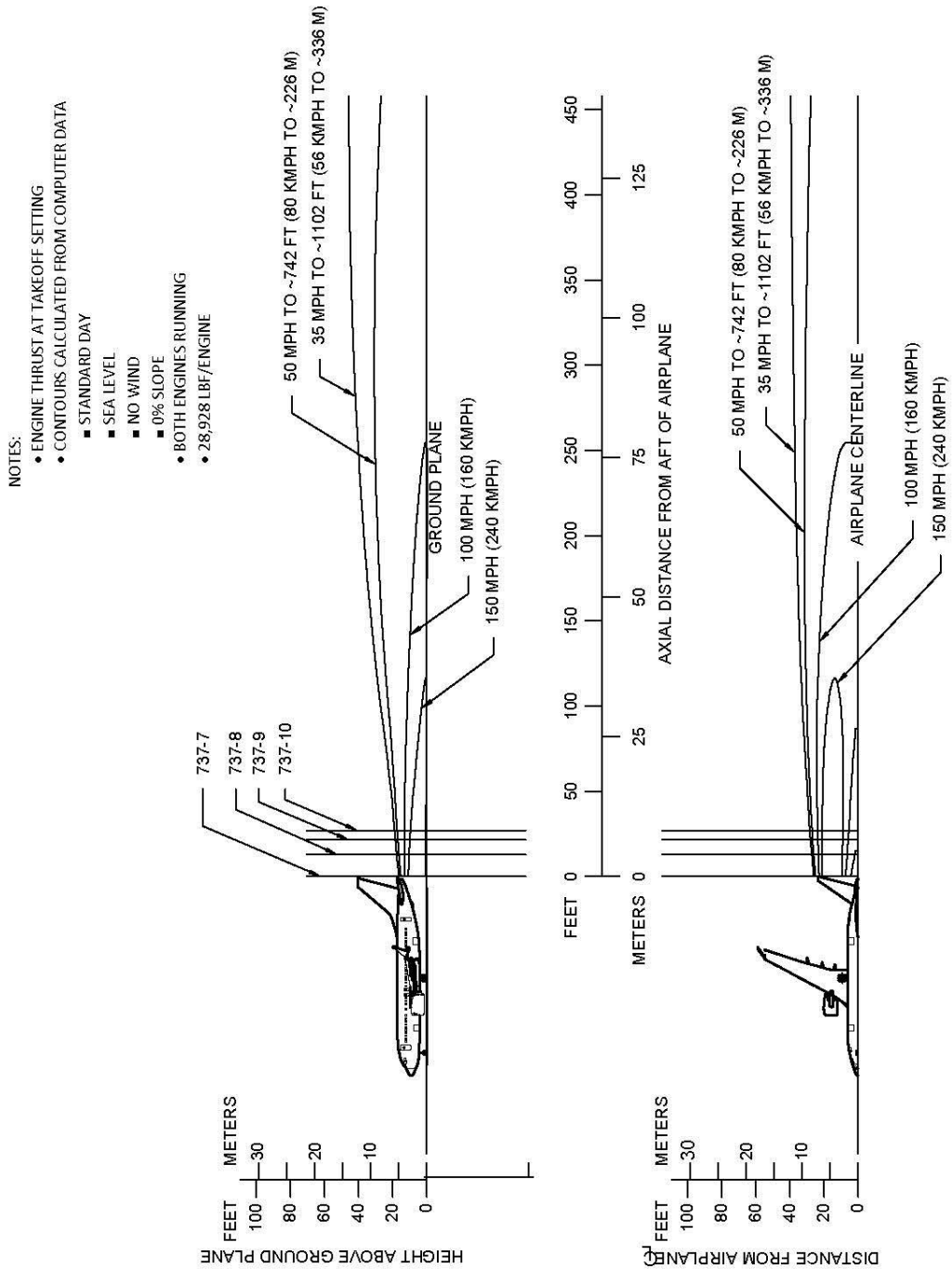

6.1.19 Jet Engine Exhaust Temperature Contours – Idle/Breakaway Thrust: All Models

Temperature contours for idle/breakaway power conditions are not shown as the maximum temperature aft of all 737 MAX models is predicated to be less than 100°F (38°C) for standard day conditions of 59°F (15°C).

6.1.20 Jet Engine Exhaust Temperature Contours – Takeoff Thrust: Model 737-7

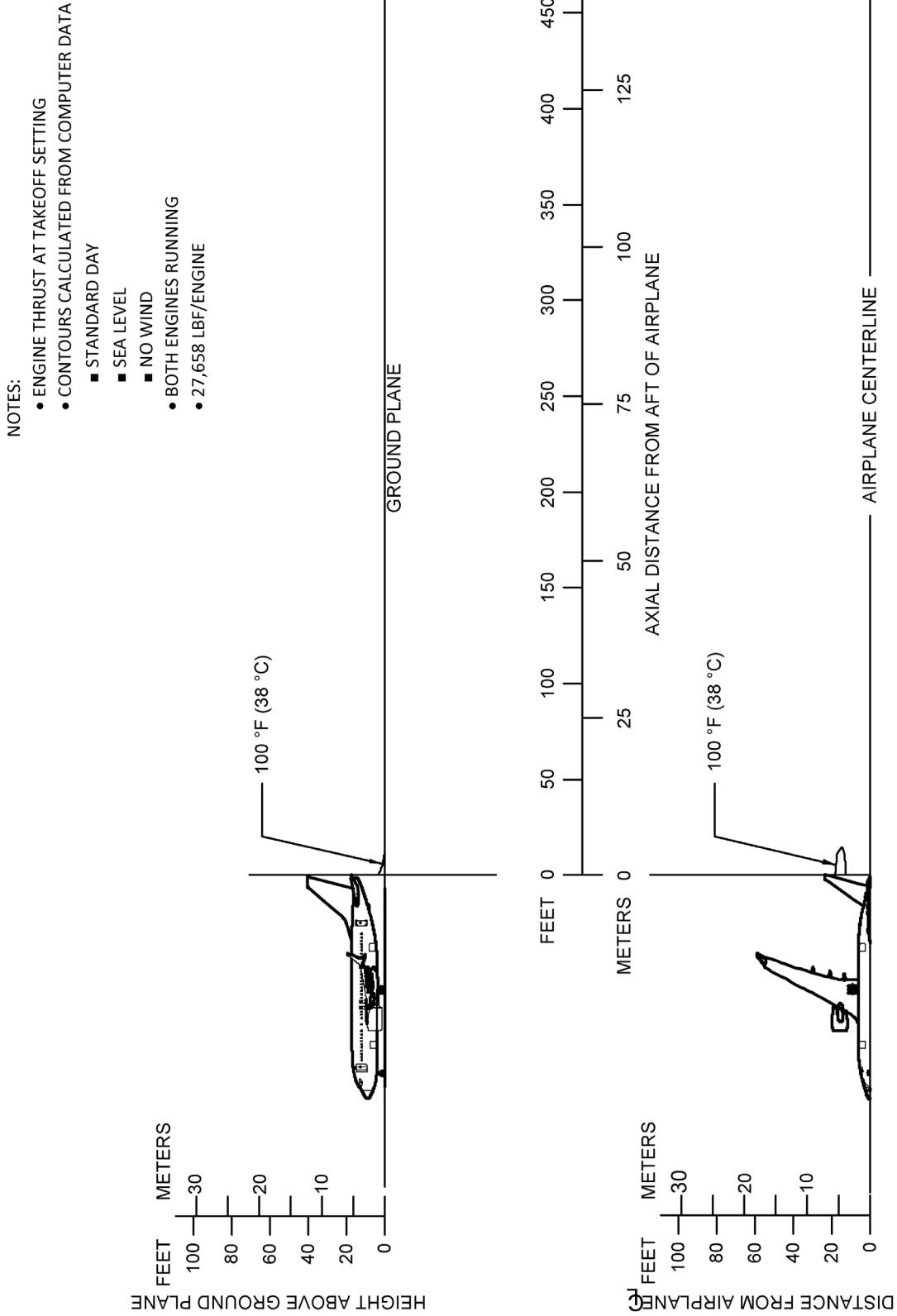

D6-38A004

6.1.21 Jet Engine Exhaust Temperature Contours – Takeoff Thrust: Model 737-8 / -8-200 / BBJ MAX 8

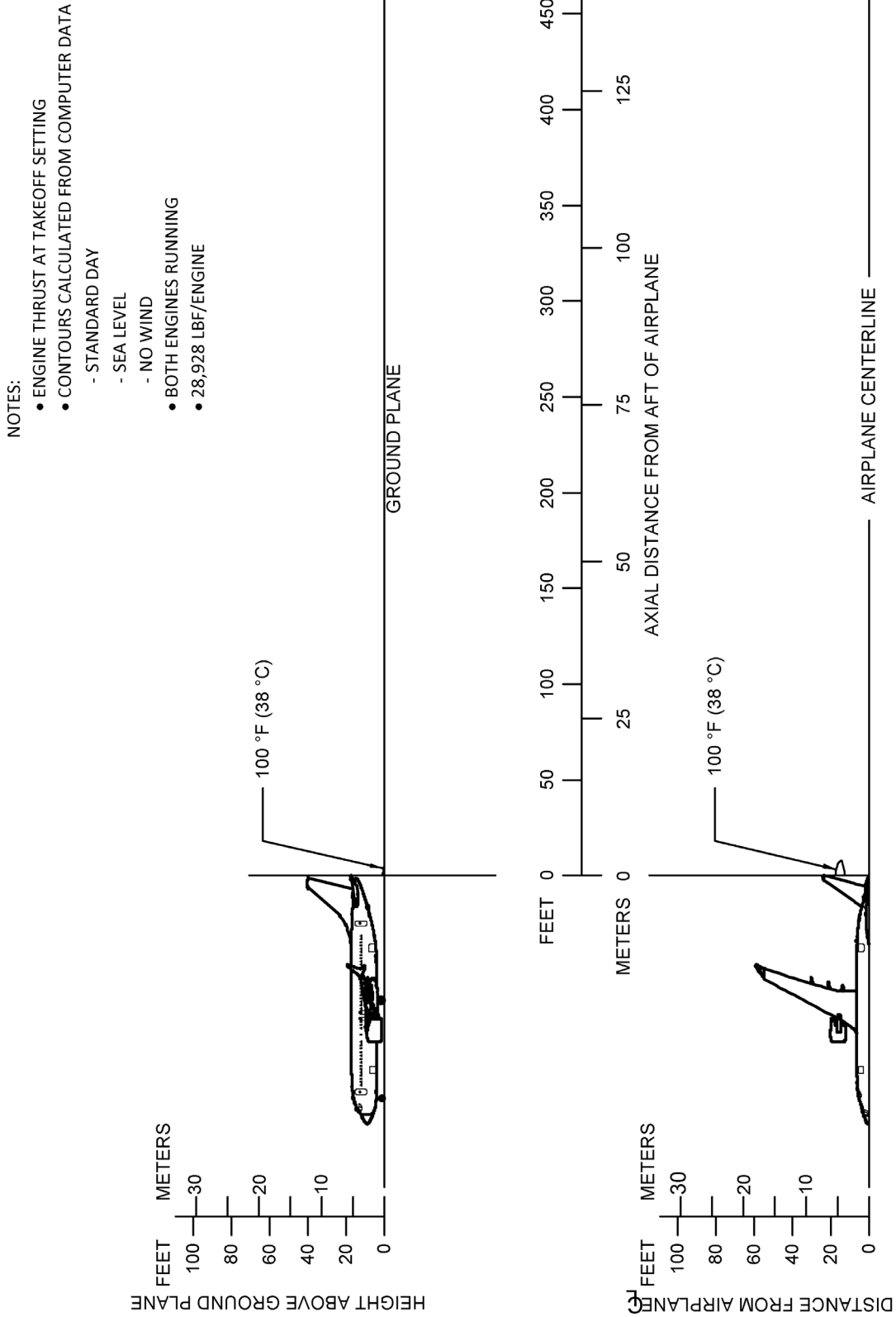

D6-38A004

6.1.22 Jet Engine Exhaust Temperature Contours – Takeoff Thrust: Model 737-9 / BBJ MAX 9

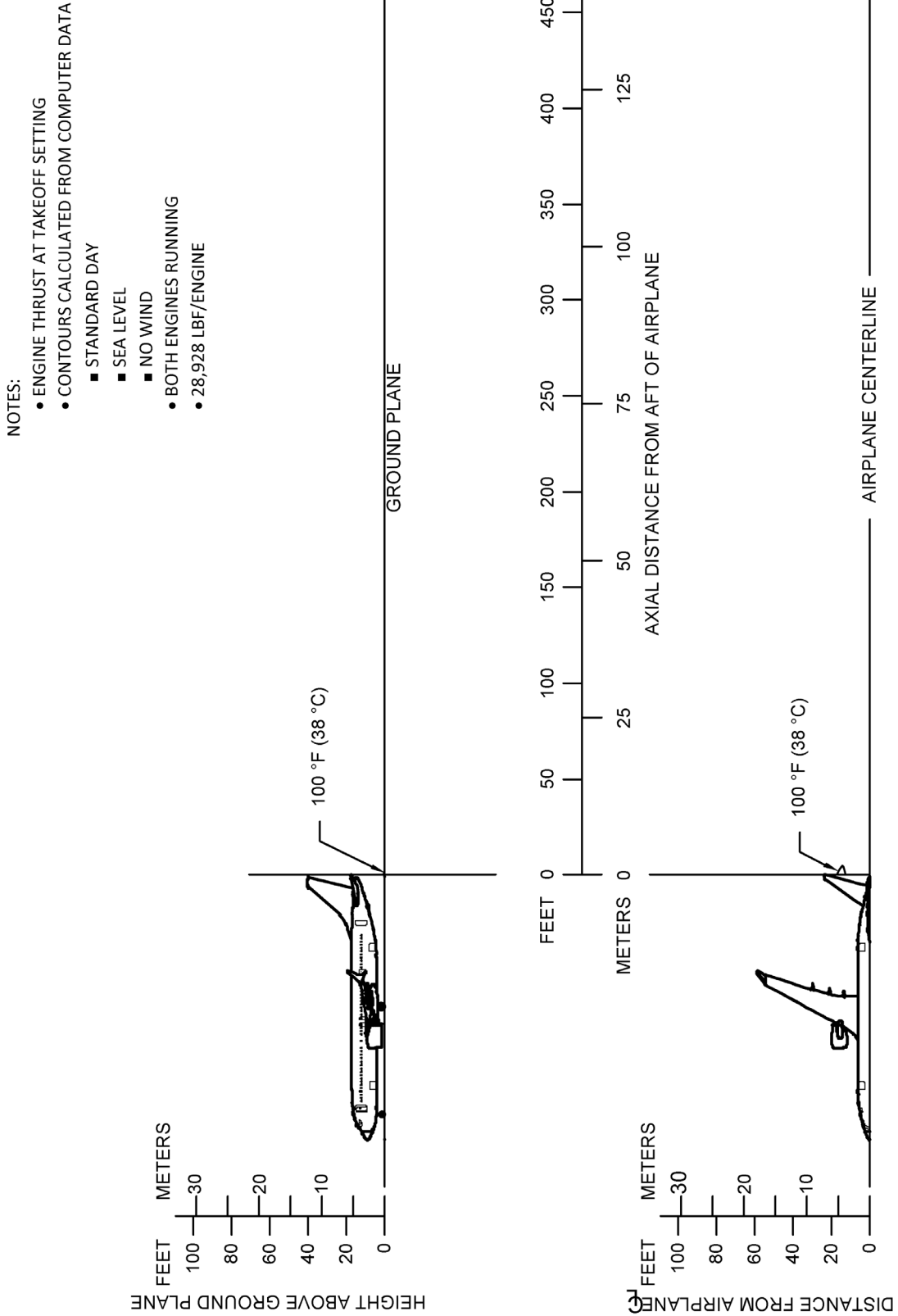

D6-38A004

6.1.23 Inlet Hazard Areas: All Models

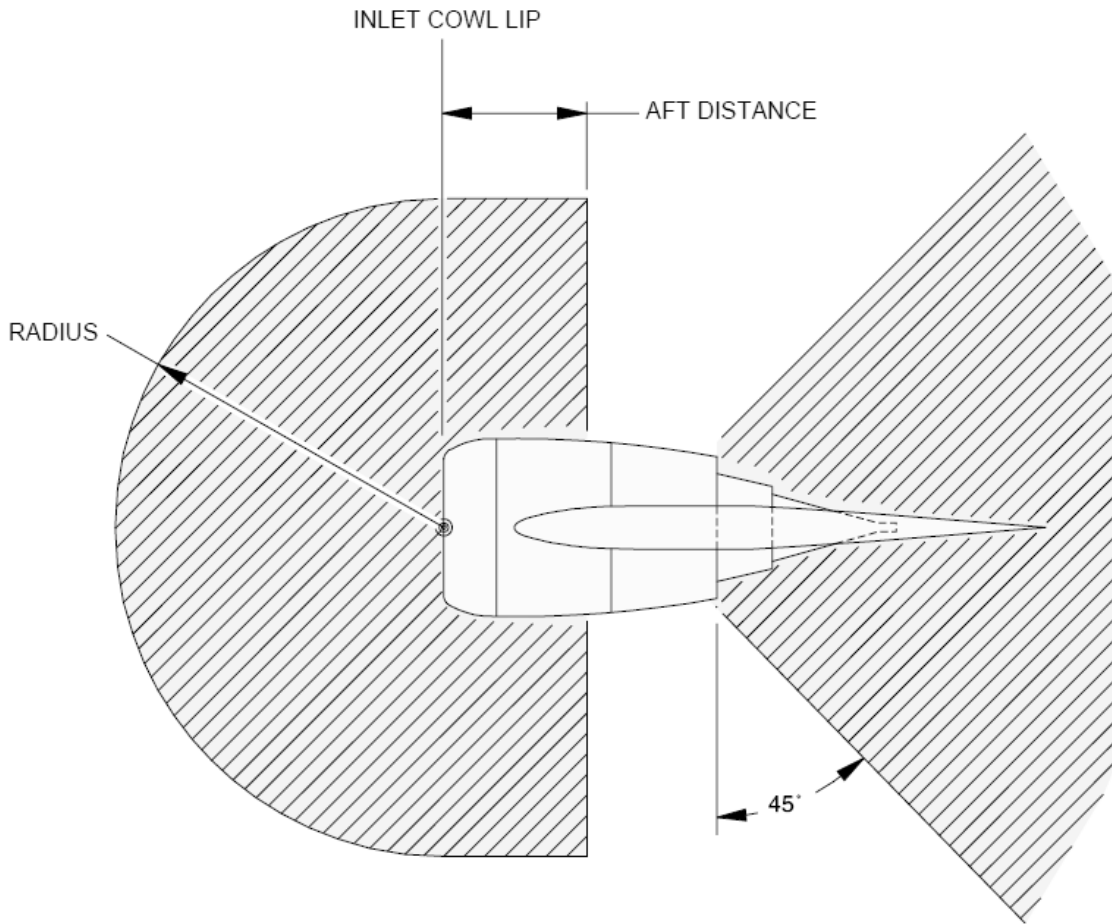

INLET HAZARD AREA

	RADIUS		AFT DISTANCE	
IDLE THRUST	10.6 FT	3.2 M	4.5 FT	1.4 M
BREAKAWAY THRUST	15.0 FT	4.6 M	9.2 FT	2.8 M
TAKEOFF THRUST	22.7 FT	6.9 M	10.6 FT	3.2 M

6.2 AIRPORT AND COMMUNITY NOISE

Airport noise is of major concern to the airport and community planner. The airport is a major element in the community's transportation system and, as such, is vital to its growth. However, the airport must also be a good neighbor, and this can be accomplished only with proper planning. Since aircraft noise extends beyond the boundaries of the airport, it is vital to consider the impact on surrounding communities. Many means have been devised to provide the planner with a tool to estimate the impact of airport operations. Too often they oversimplify noise to the point where the results become erroneous. Noise is not a simple subject; therefore, there are no simple answers.

The cumulative noise contour is an effective tool. However, care must be exercised to ensure that the contours, used correctly, estimate the noise resulting from aircraft operations conducted at an airport.

The size and shape of the single-event contours, which are inputs into the cumulative noise contours, are dependent upon numerous factors. They include the following:

1. Operational Factors
 - a. Aircraft Weight - Aircraft weight is dependent on distance to be traveled, en route winds, payload, and anticipated aircraft delay upon reaching the destination.
 - b. Engine Power Settings - The rates of ascent and descent and the noise levels emitted at the source are influenced by the power setting used.
 - c. Airport Altitude - Higher airport altitude will affect engine performance and thus can influence noise.
2. Atmospheric Conditions-Sound Propagation
 - a. Wind - With stronger headwinds, the aircraft can take off and climb more rapidly relative to the ground. Also, winds can influence the distribution of noise in surrounding communities.
 - b. Temperature and Relative Humidity - The absorption of noise in the atmosphere along the transmission path between the aircraft and the ground observer varies with both temperature and relative humidity.
3. Surface Condition-Shielding, Extra Ground Attenuation (EGA)
 - a. Terrain - If the ground slopes down after takeoff or up before landing, noise will be reduced since the aircraft will be at a higher altitude above ground. Additionally, hills, shrubs, trees, and large buildings can act as sound buffers.

All these factors can alter the shape and size of the contours appreciably. To demonstrate the effect of some of these factors, estimated noise level contours for two different

operating conditions are shown below. These contours reflect a given noise level upon a ground level plane at runway elevation.

Condition 1

Landing	Takeoff
Maximum Structural Landing Weight	Maximum Design Takeoff Weight
10-knot Headwind	Zero Wind
3° Approach	84 °F
84 °F	Humidity 15%
Humidity 15%	

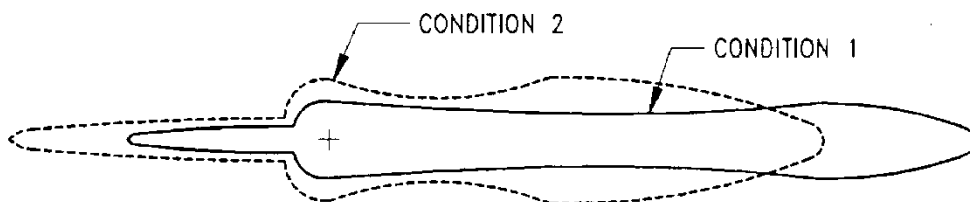

Condition 2

Landing	Takeoff
85% of Maximum Structural Landing Weight	80% of Maximum Design Takeoff Weight
10-knot Headwind	10-knot Headwind
3° Approach	59 °F
59 °F	Humidity 70%
Humidity 70%	

As indicated from these data, the contour size varies substantially with operating and atmospheric conditions. Most aircraft operations are, of course, conducted at less than maximum design weights because average flight distances are much shorter than maximum aircraft range capability and average load factors are less than 100%. Therefore, in developing cumulative contours for planning purposes, it is recommended that the airlines serving a particular city be contacted to provide operational information.

In addition, there are no universally accepted methods for developing aircraft noise contours or for relating the acceptability of specific zones to specific land uses. It is therefore expected that noise contour data for particular aircraft and the impact assessment methodology will be changing. To ensure that the best currently available information of

this type is used in any planning study, it is recommended that it be obtained directly from the Office of Environmental Quality in the Federal Aviation Administration in Washington, D.C.

It should be noted that the contours shown herein are only for illustrating the impact of operating and atmospheric conditions and do not represent the single-event contour of the family of aircraft described in this document. It is expected that the cumulative contours will be developed as required by planners using the data and methodology applicable to their specific study.

7.0 PAVEMENT DATA

7.1 GENERAL INFORMATION

A brief description of the pavement charts that follow will help in their use for airport planning. Each airplane configuration is depicted with a minimum range of five loads imposed on the main landing gear to aid in interpolation between the discrete values shown. All curves for any single chart represent data based on rated loads and tire pressures considered normal and acceptable by current aircraft tire manufacturer's standards. Tire pressures, where specifically designated on tables and charts, are at values obtained under loaded conditions as certificated for commercial use.

Section 7.2 presents basic data on the landing gear footprint configuration, maximum design taxi loads, and tire sizes and pressures.

Maximum pavement loads for certain critical conditions at the tire-to-ground interface are shown in Section 7.3, with the tires having equal loads on the struts.

Pavement requirements for commercial airplanes are customarily derived from the static analysis of loads imposed on the main landing gear struts. The charts in Section 7.4 are provided in order to determine these loads throughout the stability limits of the airplane at rest on the pavement. These main landing gear loads are used as the point of entry to the pavement design charts, interpolating load values where necessary.

The flexible pavement design curves based on the US Army Corp of Engineers Method and the rigid pavement curves based on the Portland Cement Association Design Method are no longer provided in Sections 7.5 and 7.7. Refer to the State's design standards for pavement design requirements. For US airports, refer to FAA Advisory Circular (AC) 150/5320-6, "Pavement Design" and pavement design program FAARFIELD for flexible and rigid pavement design requirements.

The Load Classification Number (LCN) curves are no longer provided in section 7.6 and 7.8 since the LCN system for reporting pavement strength is obsolete, being replaced by the ICAO recommended ACN/PCN system in 1983. For questions regarding the LCN system contact Boeing Airport Operations Engineering:

AirportCompatibility@boeing.com

The ACN/PCN system (Section 7.10) as referenced in ICAO Annex 14, "Aerodromes," 8th Edition, July 2018, provides a standardized international airplane/pavement rating system replacing the various S, T, TT, LCN, AUW, ISWL, etc., rating systems used throughout the world. ACN is the Aircraft Classification Number and PCN is the Pavement Classification Number. An aircraft having an ACN equal to or less than the PCN can operate on the pavement subject to any limitation on the tire pressure. Numerically, the ACN is two times the derived single-wheel load expressed in thousands of kilograms, where the derived single wheel load is defined as the load on a single tire inflated to 181 psi (1.25 MPa) that would have the same pavement requirements as the aircraft.

Computationally, the ACN/PCN system uses the PCA program PDILB for rigid pavements and S-77-1 for flexible pavements to calculate ACN values.

The ACR-PCR system (Section 7.11) follows the proposed amendment to ICAO Annex 14 replacing the current ACN-PCN system. ACR is the Aircraft Classification Rating and PCR is the Pavement Classification Rating. An aircraft having an ACR equal to or less than the PCR can operate on the pavement subject to any limitation on the tire pressure. Numerically, the ACR is two times the derived single-wheel load expressed in hundreds of kilograms, where the derived single wheel load is defined as the load on a single tire inflated to 218 psi (1.5 MPa) that would have the same pavement requirements as the aircraft.

The method of pavement evaluation is left up to the airport with the results of their evaluation presented as follows:

PCR	PAVEMENT TYPE	SUBGRADE CATEGORY	TIRE PRESSURE CATEGORY	EVALUATION METHOD
	R = Rigid	A = High	W = No Limit	T = Technical
	F = Flexible	B = Medium	X = To 254 psi (1.75 MPa)	U = Using Aircraft
		C = Low	Y = To 181 psi (1.25 MPa)	
		D = Ultra Low	Z = To 73 psi (0.5 MPa)	

ACN values for flexible pavements are calculated for the following four subgrade categories:

- Code A - High Strength - CBR 15
- Code B - Medium Strength - CBR 10
- Code C - Low Strength - CBR 6
- Code D - Ultra Low Strength - CBR 3

ACN values for rigid pavements are calculated for the following four subgrade categories:

- Code A - High Strength, $k = 552.6 \text{ pci (150 MN/m}^3\text{)}$
- Code B - Medium Strength, $k = 294.7 \text{ pci (80 MN/m}^3\text{)}$
- Code C - Low Strength, $k = 147.4 \text{ pci (40 MN/m}^3\text{)}$
- Code D - Ultra Low Strength, $k = 73.7 \text{ pci (20 MN/m}^3\text{)}$

ACR values at any mass on rigid and flexible pavements are calculated for the following four subgrade categories:

737-10 INFORMATION IS PRELIMINARY

Code A - High Strength - Subgrade Modulus, $E = 200 \text{ MPa}$ (29,008 psi)

Code B - Medium Strength - Subgrade Modulus, $E = 120 \text{ MPa}$ (17,405 psi)

Code C - Low Strength - Subgrade Modulus, $E = 80 \text{ MPa}$ (11,603 psi)

Code D - Ultra Low Strength - Subgrade Modulus, $E = 50 \text{ MPa}$ (7,252 psi)

7.2 LANDING GEAR FOOTPRINT

7.2.1 Landing Gear Footprint: All Models

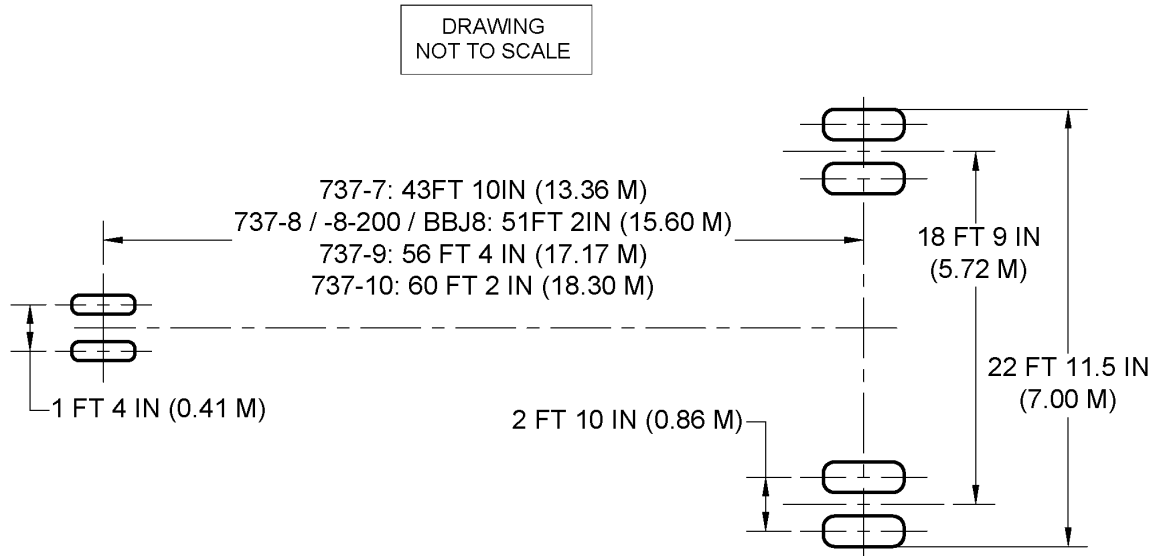

	UNITS	737-7	737-8	737 BBJ MAX 8	737-8-200	737-9 / BBJ MAX 9	737-10
MAXIMUM DESIGN TAXI WEIGHT	LB	177,500	182,700	181,700		195,200	198,400
	KG	80,512	82,871	82,417		88,541	89,992
NOSE GEAR TIRE SIZE	IN	27 x 7.75 R 15 12 PR					
NOSE GEAR TIRE PRESSURE	PSI	205	190			170	190
	MPa	1.41	1.31			1.17	1.31
MAIN GEAR TIRE SIZE	IN	H44.5 x 16.5 R 21 30 PR				H44.5 x 16.5 R 21 32 PR	
MAIN GEAR TIRE PRESSURE	PSI	205	212	210	212	230	235
	MPa	1.41	1.46	1.45	1.46	1.59	1.62

7.3 MAXIMUM PAVEMENT LOADS

7.3.1 Maximum Pavement Loads: All Models

V_{NG} = MAXIMUM VERTICAL NOSE GEAR GROUND LOAD AT MOST FORWARD CENTER OF GRAVITY

V_{MG} = MAXIMUM VERTICAL MAIN GEAR GROUND LOAD AT MOST AFT CENTER OF GRAVITY

H = MAXIMUM HORIZONTAL GROUND LOAD FROM BRAKING

NOTE: ALL LOADS CALCULATED USING AIRPLANE MAXIMUM DESIGN TAXI WEIGHT

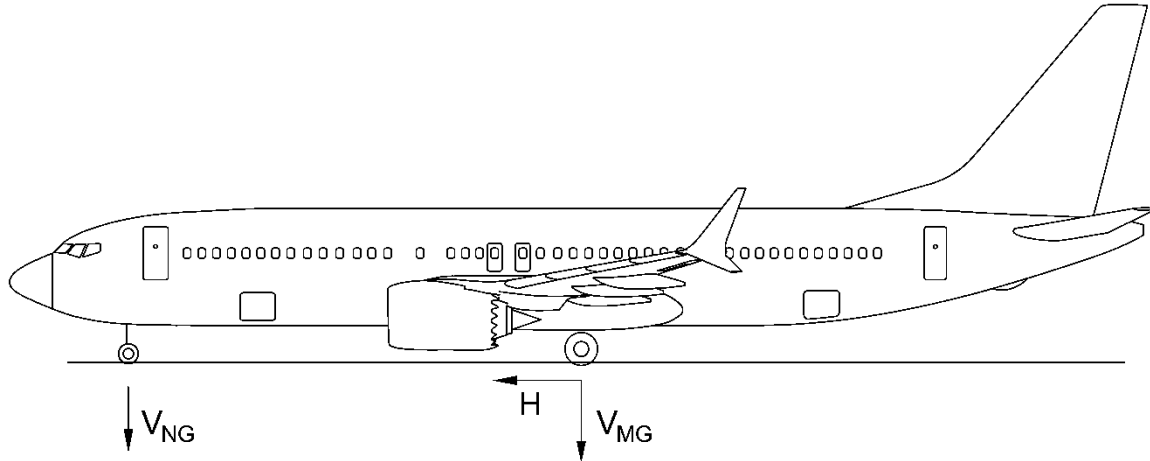

AIRPLANE MODEL	UNITS	MAX DESIGN TAXI WEIGHT	V_{NG}		V_{MG} PER STRUT AT MAX LOAD AT STATIC AFT C.G.	H PER STRUT	
			STATIC AT MOST FWD C.G.	STATIC + BRAKING 10 FT/SEC ² DECEL		STEADY BRAKING 10 FT/SEC ² DECEL	AT INSTANTANEOUS BRAKING ($\mu = 0.8$)
737-7	LB	177,500	18,918	30,637	82,866	27,566	66,293
	KG	80,512	8,581	13,897	37,587	12,504	30,070
737-8 / -8-200 / BBJ MAX 8	LB	182,700	15,894	26,282	85,258	28,373	68,206
	KG	82,871	7,209	11,921	38,672	12,870	30,938
737-9 / BBJ MAX 9	LB	195,200	15,514	25,639	91,868	30,315	73,494
	KG	88,541	7,037	11,630	41,671	13,751	33,336
737-10	LB	198,400	13,613	23,251	93,679	30,812	74,944
	KG	89,992	6,175	10,546	42,492	13,976	33,994

7.4 LANDING GEAR LOADING ON PAVEMENT

7.4.1 Landing Gear Loading on Pavement: Model 737-7

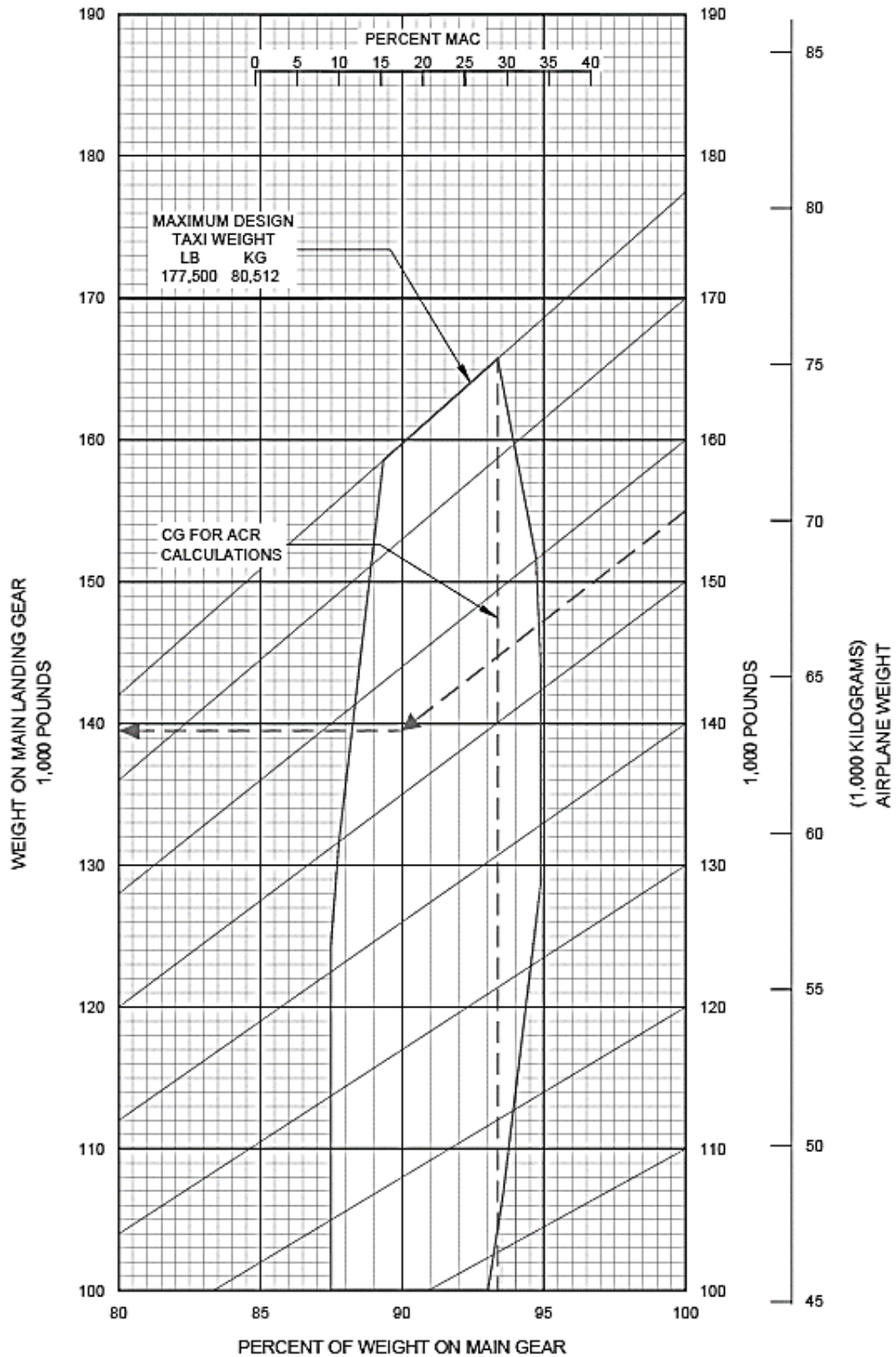

D6-38A004

7.4.2 Landing Gear Loading on Pavement: Model 737-8 / -8-200 / BBJ MAX 8

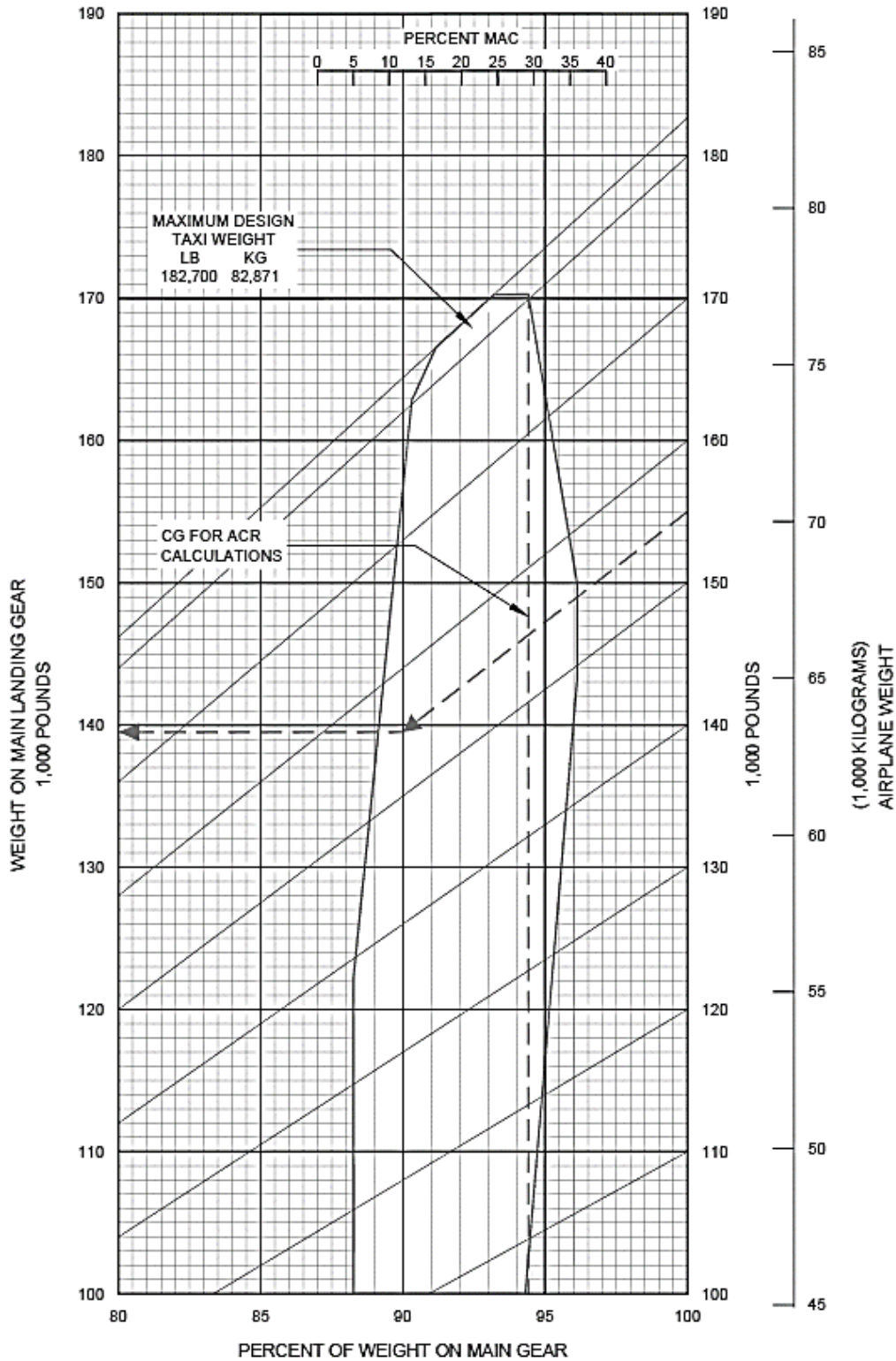

D6-38A004

7.4.3 Landing Gear Loading on Pavement: Model 737-9

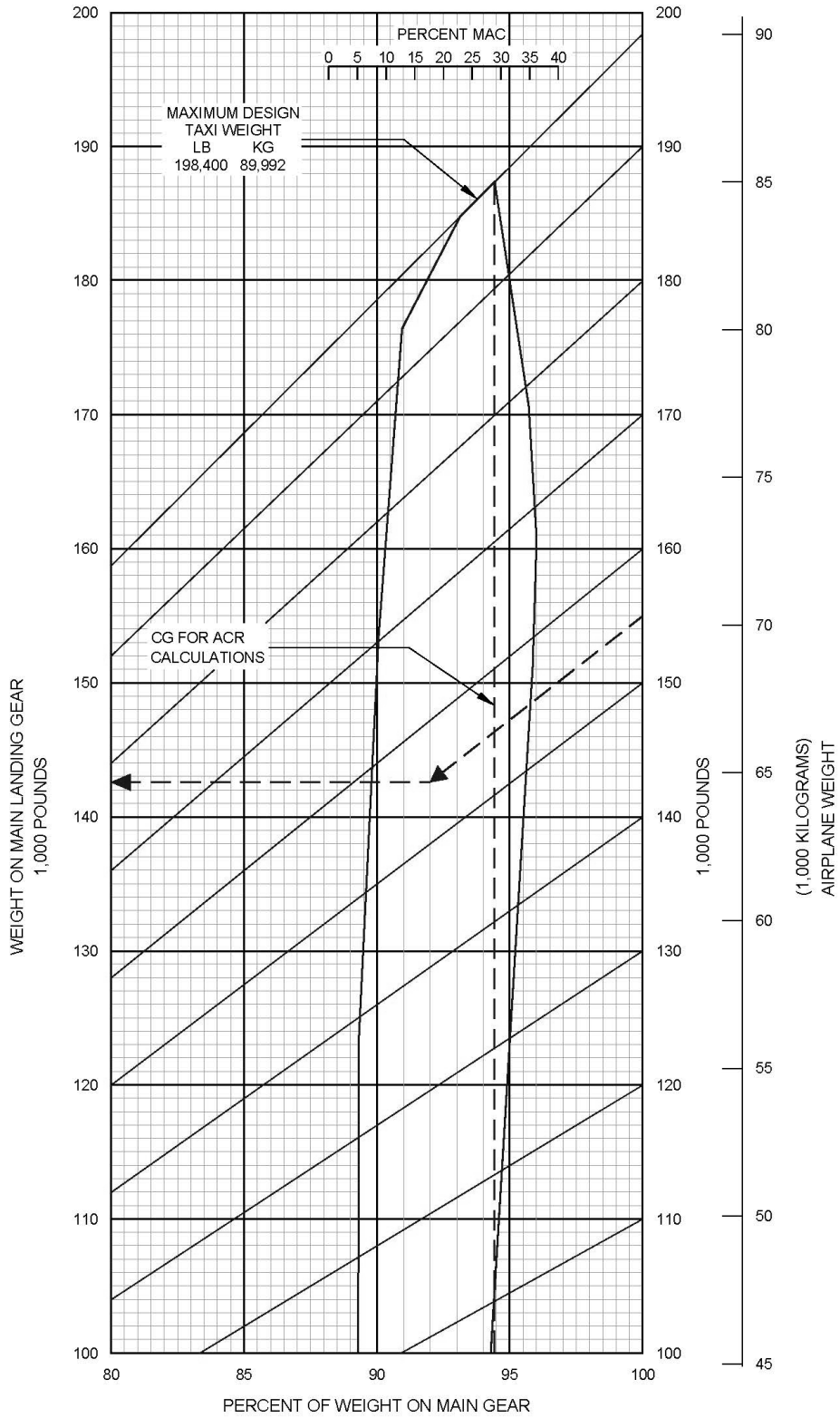

D6-38A004

7.4.4 Landing Gear Loading on Pavement: Model 737-10

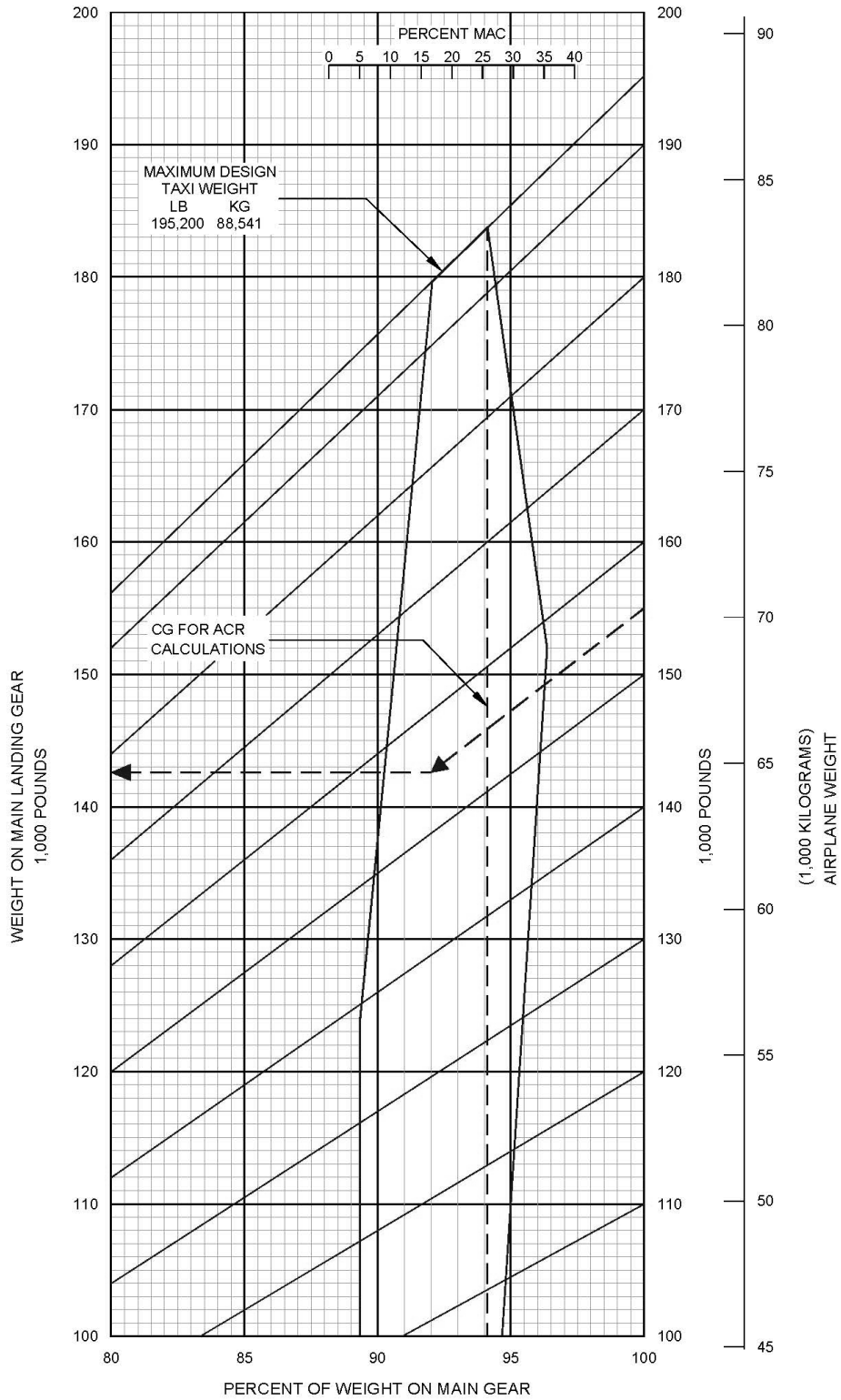

D6-38A004

7.5 FLEXIBLE PAVEMENT REQUIREMENTS - FAA DESIGN METHOD

For the flexible pavement design refer to the FAA AC 150/5320-6 "Airport Pavement Design and Evaluation" and pavement design program FAARFIELD. Both are available on the FAA website:

FAA AC 150/5320-6: https://www.faa.gov/airports/resources/advisory_circulars/
FAARFIELD: https://www.faa.gov/airports/engineering/design_software/

7.6 FLEXIBLE PAVEMENT REQUIREMENTS - LCN CONVERSION

The Load Classification Number (LCN) curves are no longer provided in section 7.6 and 7.8 since the LCN system for reporting pavement strength is obsolete, being replaced by the ICAO recommended ACN/PCN system in 1983. For questions regarding the LCN system contact Boeing Airport Operations Engineering:

AirportCompatibility@boeing.com

7.7 RIGID PAVEMENT REQUIREMENTS - PORTLAND CEMENT ASSOCIATION DESIGN METHOD

The rigid pavement requirements based on the Portland Cement Association method are no longer provided.

7.8 RIGID PAVEMENT REQUIREMENTS - LCN CONVERSION

The Load Classification Number (LCN) curves are no longer provided in section 7.6 and 7.8 since the LCN system for reporting pavement strength is obsolete, being replaced by the ICAO recommended ACN/PCN system in 1983. For questions regarding the LCN system contact Boeing Airport Operations Engineering:

AirportCompatibility@boeing.com

7.9 RIGID PAVEMENT REQUIREMENTS - FAA DESIGN METHOD

For the rigid pavement design refer to the FAA AC 150/5320-6 “Airport Pavement Design and Evaluation” and pavement design program FAARFIELD. Both are available on the FAA website:

FAA AC 150/5320-6: https://www.faa.gov/airports/resources/advisory_circulars/
FAARFIELD: https://www.faa.gov/airports/engineering/design_software/

7.10 ACN/PCN REPORTING SYSTEM - FLEXIBLE AND RIGID PAVEMENTS

To determine the ACN of an aircraft on flexible or rigid pavement, both the aircraft gross weight and the subgrade strength category must be known. In the chart in Section 7.10.1, for an aircraft with gross weight of 140,000 lb and high subgrade strength, the flexible pavement ACN is 33. In Section 7.10.5, for the same gross weight and subgrade strength, the rigid pavement ACN is 38.

The following table provides ACN data in tabular format similar to the one used by ICAO in the “Aerodrome Design Manual Part 3, Pavements”. If the ACN for an intermediate weight between maximum taxi weight and the empty weight of the aircraft is required, Figures 7.10.1 through 7.10.8 should be consulted.

AIRCRAFT TYPE	MAXIMUM TAXI WEIGHT ----- MINIMUM WEIGHT *[1] lb (kg)	LOAD ON ONE MAIN GEAR LEG (%)	TIRE PRESSURE psi (MPa)	ACN FOR RIGID PAVEMENT SUBGRADES - pci (MN/m ³)				ACN FOR FLEXIBLE PAVEMENT SUBGRADES - CBR			
				HIGH 550 (150)	MEDIUM 300 (80)	LOW 150 (40)	ULTRA LOW 75 (20)	HIGH 15	MEDIUM 10	LOW 6	ULTRA LOW 3
737-7	177,500 (81,512)	46.69	205 (1.41)	50	53	55	57	44	46	51	56
	95,000 (43,091)			24	25	27	28	21	22	23	27
737-8 / -8-200 / BBJ MAX 8	182,700 (82,871)	46.67	212 (1.46)	52	55	57	59	45	48	53	58
	95,000 (43,091)			24	25	27	28	21	22	23	27
737-9 / BBJ MAX 9	195,200 (88,541)	47.07	230 (1.59)	59	61	64	65	50	53	58	63
	95,000 (43,091)			25	26	28	29	22	22	24	27
737-10	198,400 (89,992)	47.22	235 (1.62)	60	63	65	67	51	54	60	64
	95,000 (43,091)			25	26	28	29	22	22	24	28

*[1] Minimum weight used solely as a baseline for ACN curve generation.

7.10.1 Aircraft Classification Number - Flexible Pavement: Model 737-7

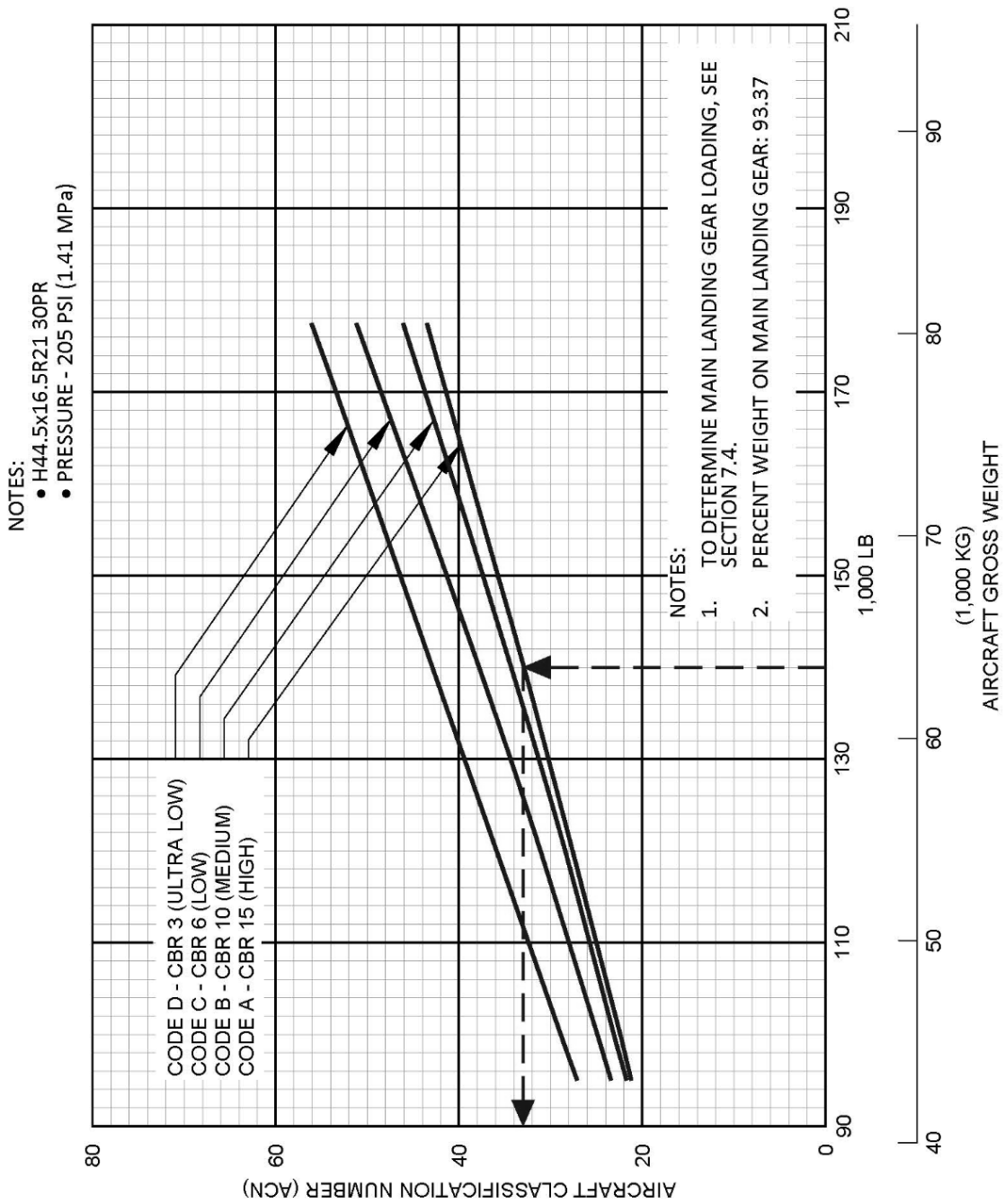

7.10.2 Aircraft Classification Number - Flexible Pavement: Model 737-8 / -8-200 / BBJ MAX 8

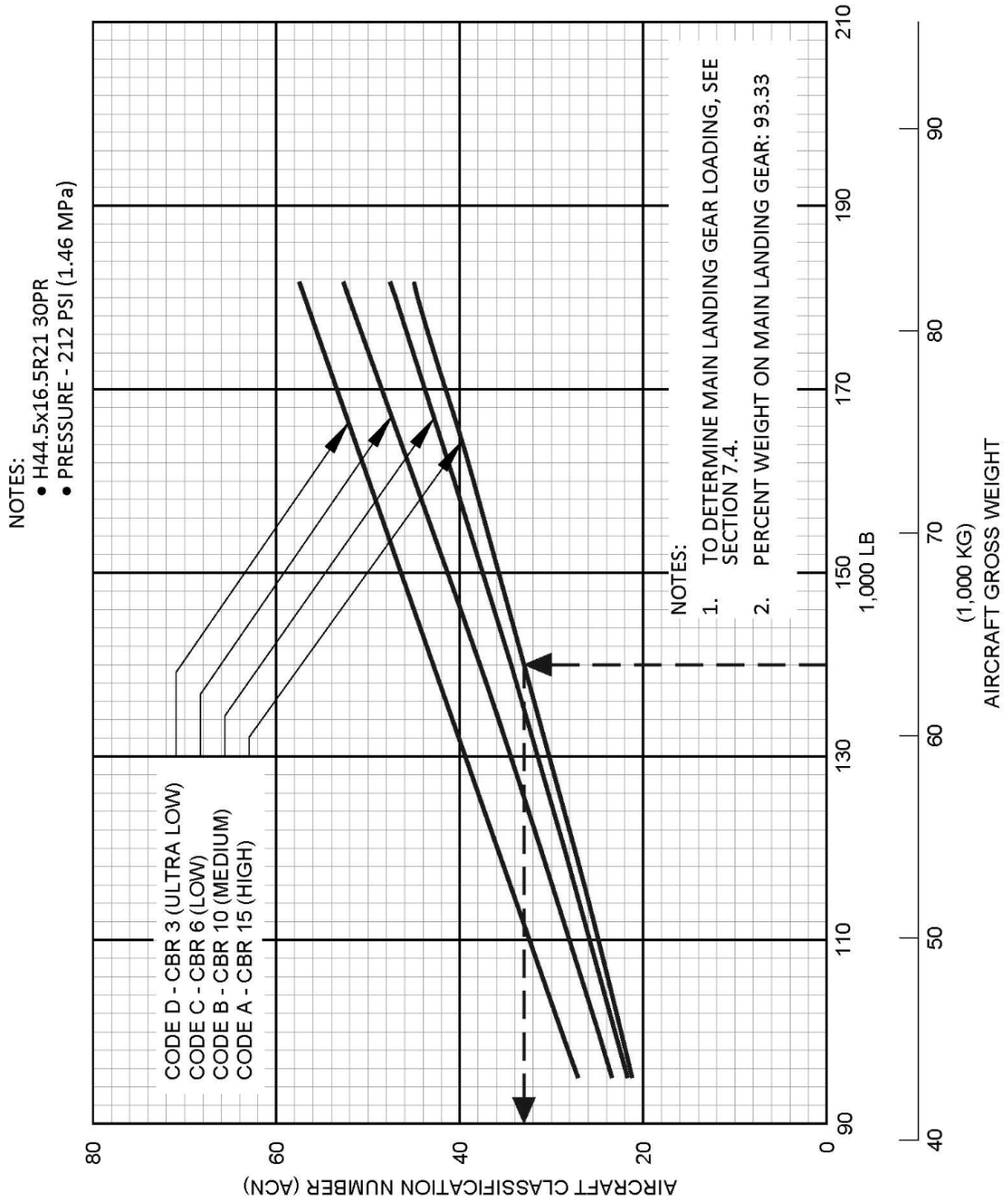

D6-38A004

7.10.3 Aircraft Classification Number - Flexible Pavement: Model 737-9 / BBJ MAX 9

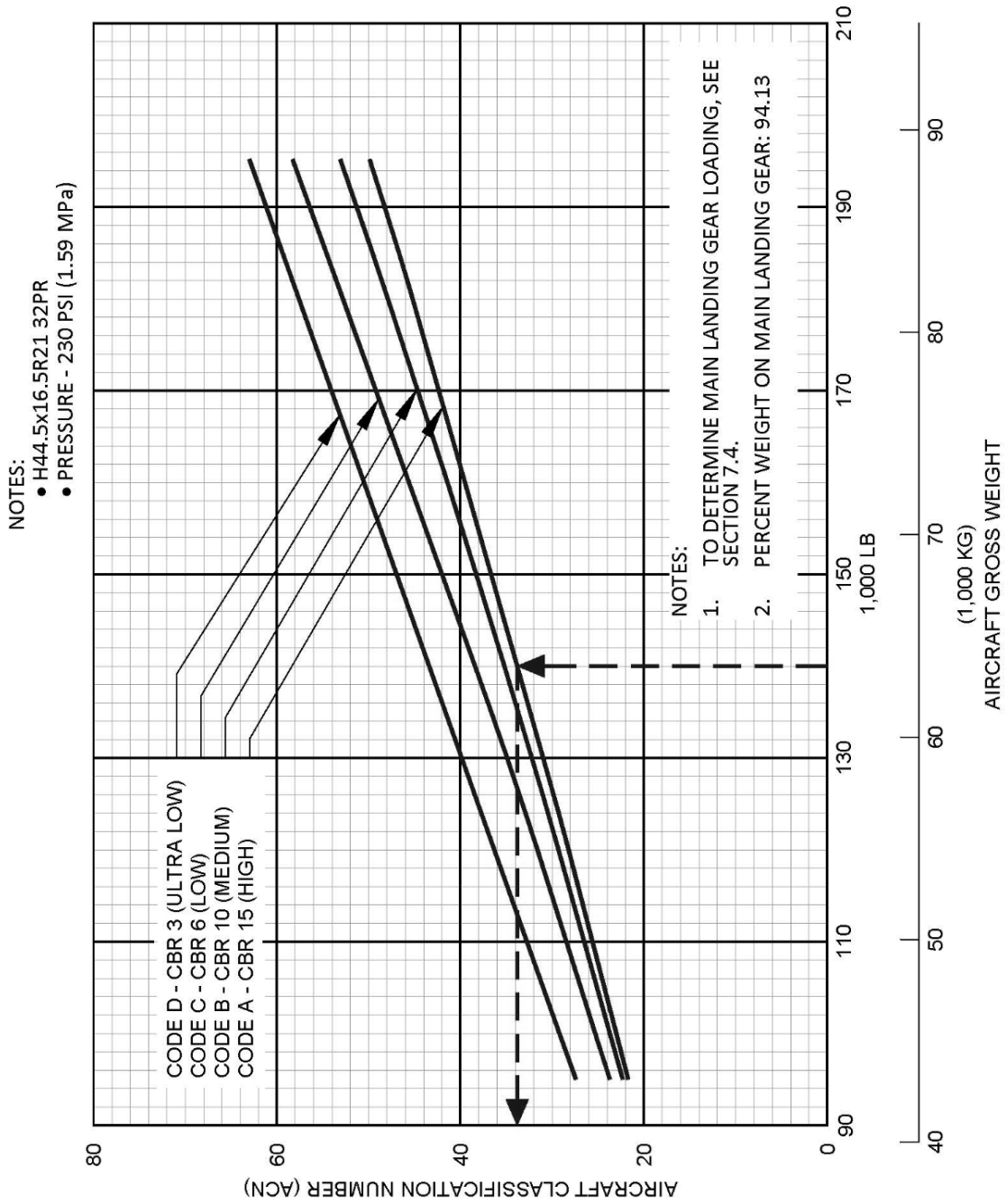

7.10.4 Aircraft Classification Number - Flexible Pavement: Model 737-10

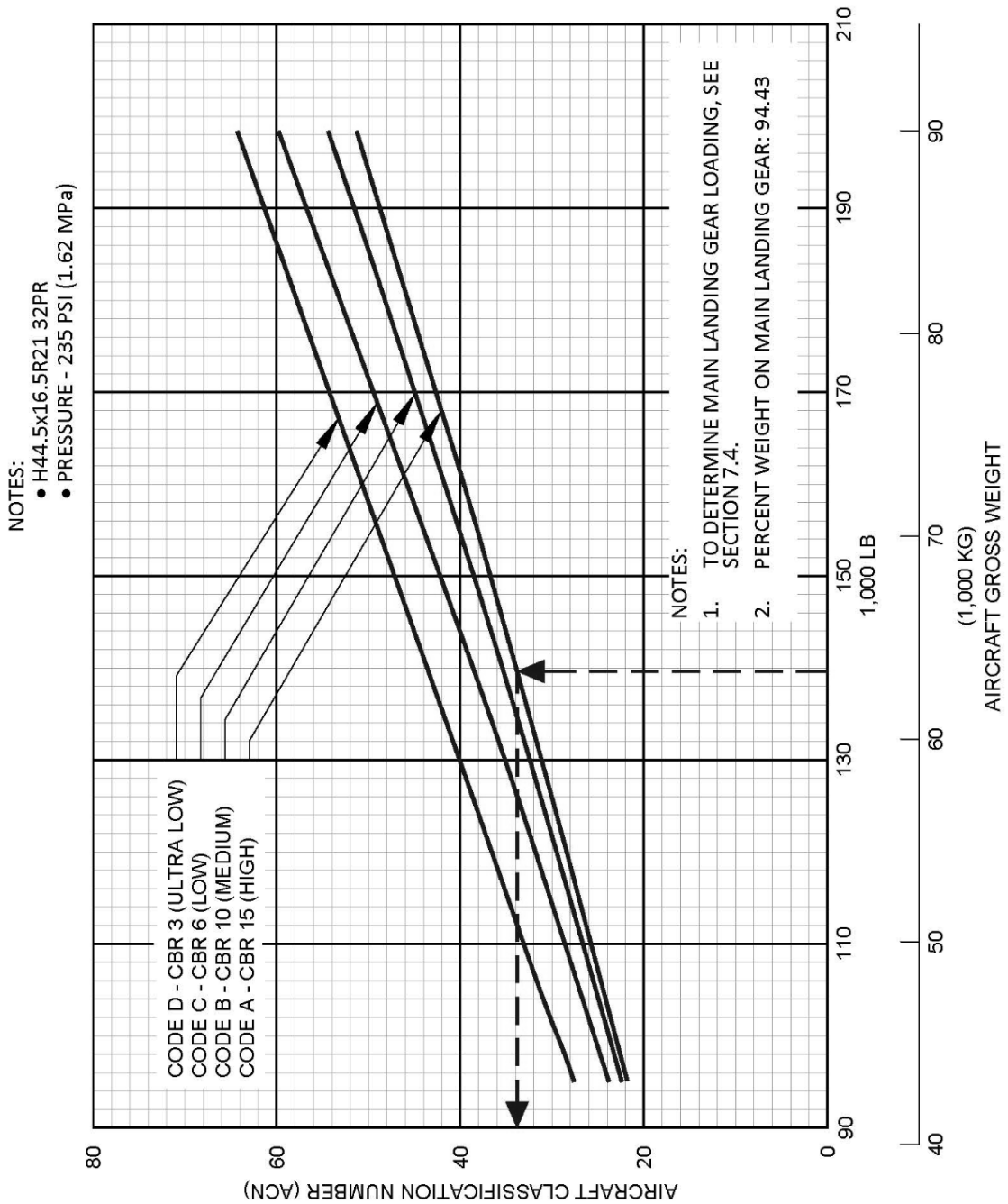

7.10.5 Aircraft Classification Number - Rigid Pavement: Model 737-7

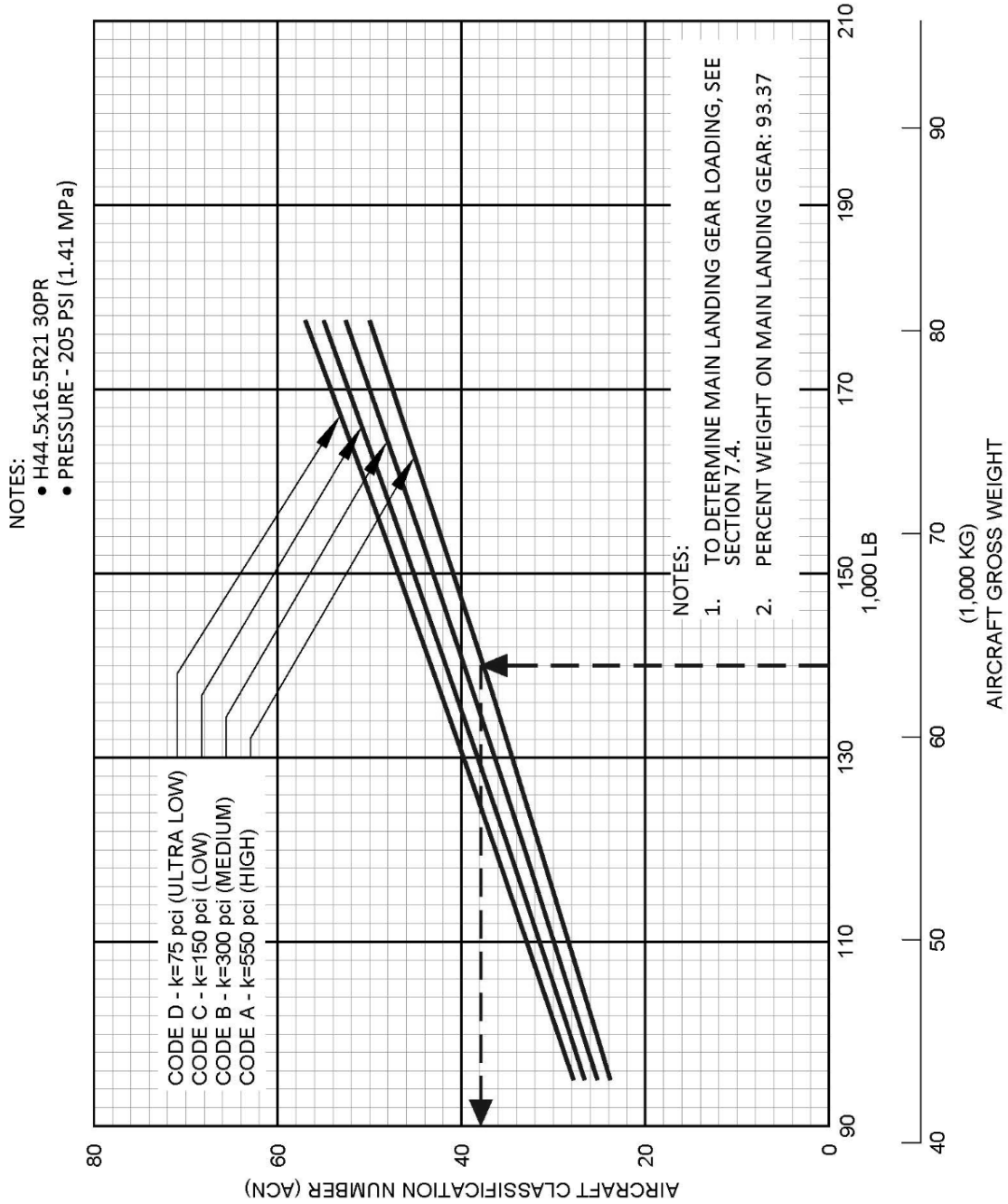

7.10.6 Aircraft Classification Number - Rigid Pavement: Model 737-8 / -8-200 / BBJ MAX 8

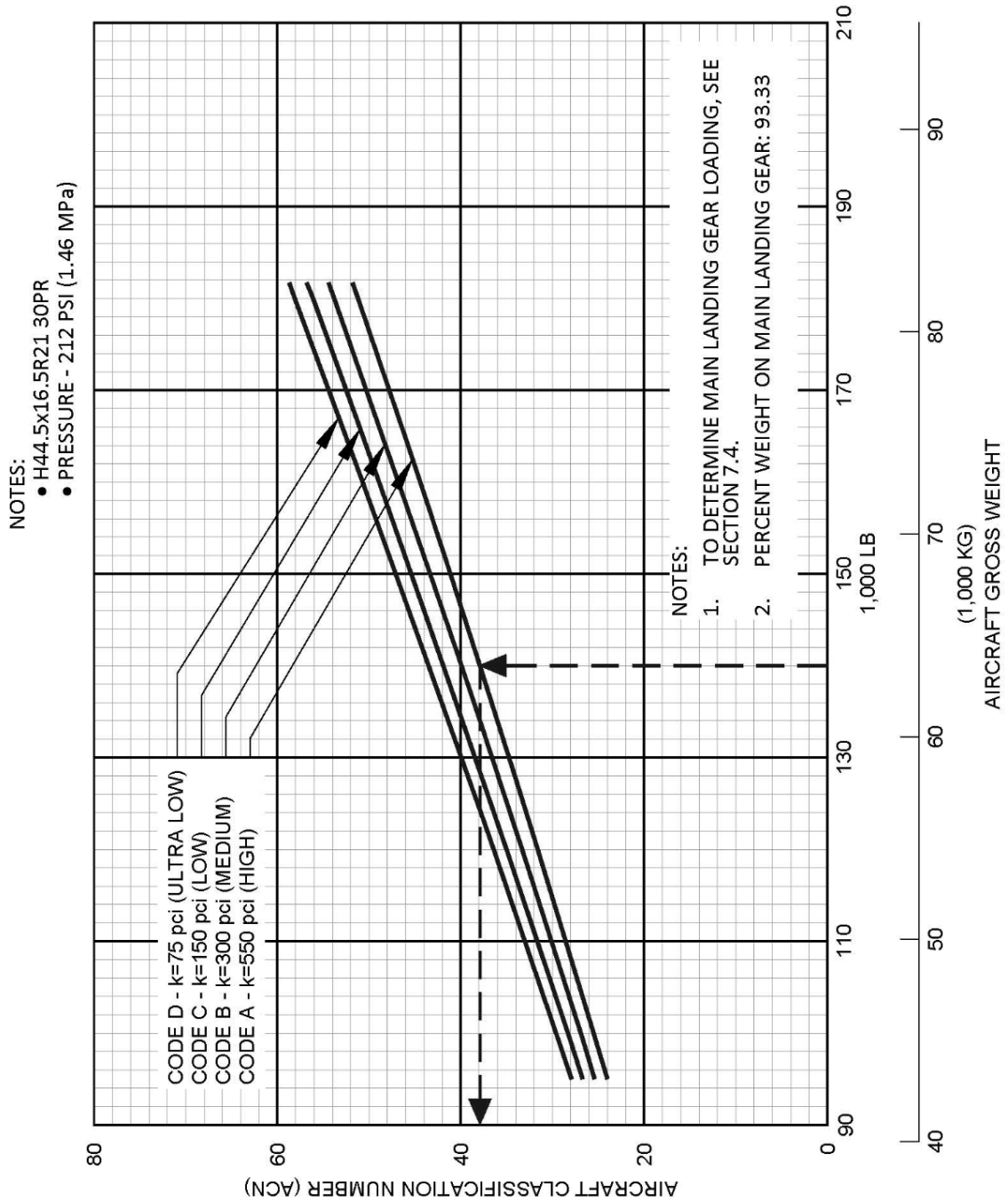

7.10.7 Aircraft Classification Number - Rigid Pavement: Model 737-9 / BBJ MAX 9

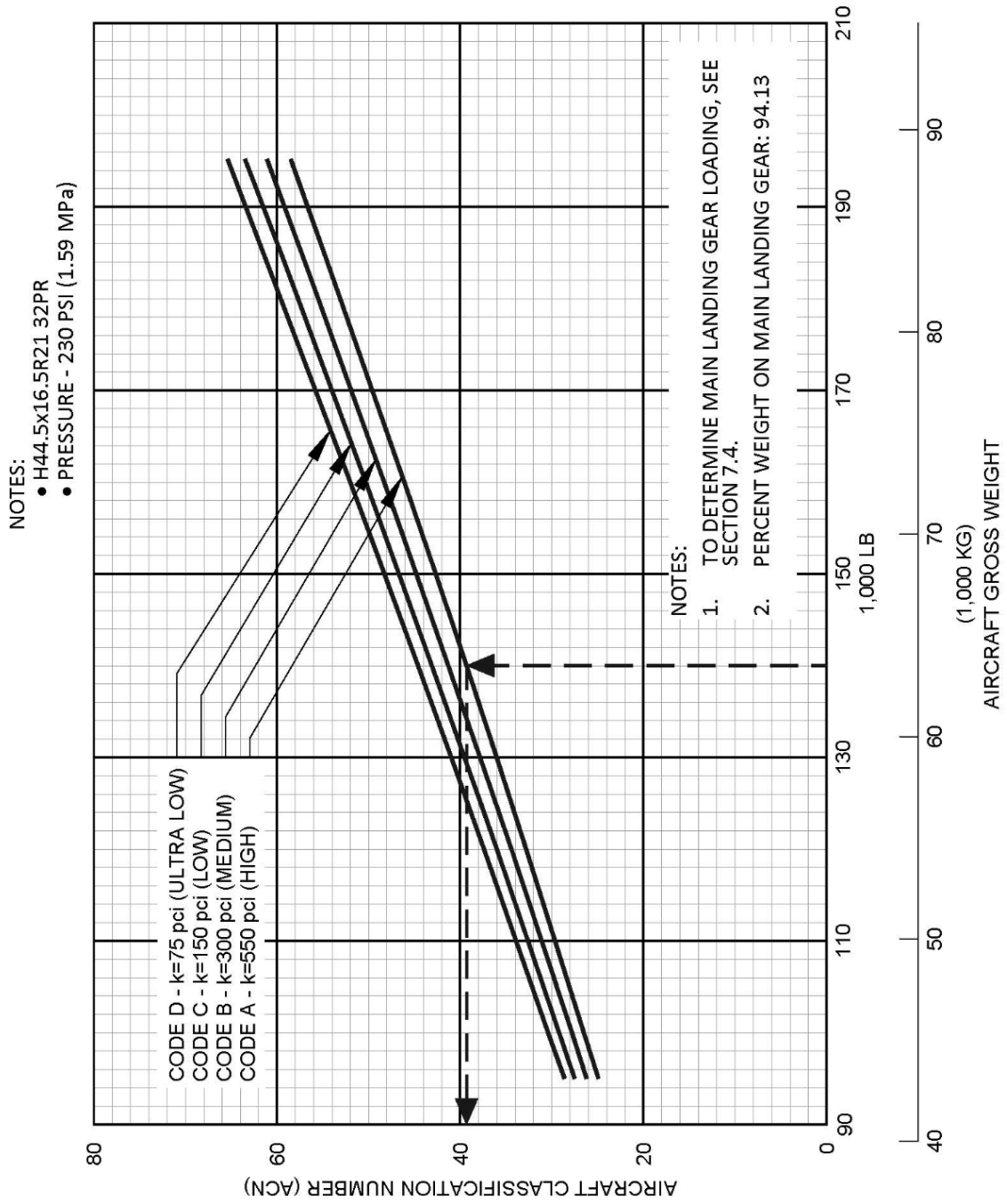

7.10.8 Aircraft Classification Number - Rigid Pavement: Model 737-10

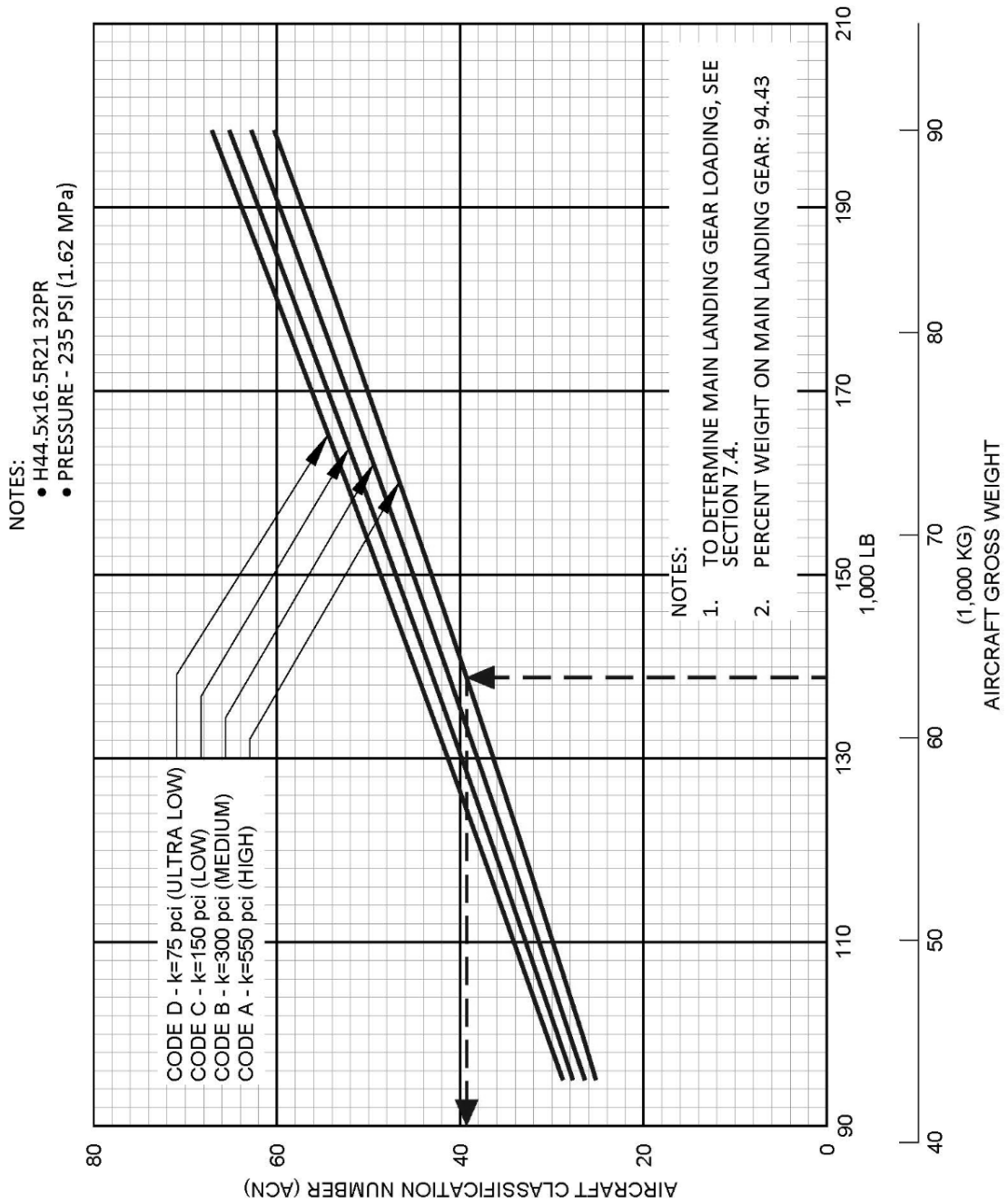

7.11 ACR/PCR REPORTING SYSTEM - FLEXIBLE AND RIGID PAVEMENTS

To determine the ACR of an aircraft on flexible or rigid pavement, both the aircraft gross weight and the subgrade strength category must be known. In the chart in Section 7.11.1, for an aircraft with gross weight of 140,000 lb and high subgrade strength, the flexible pavement ACR is 297. In Section 7.11.5, for the same gross weight and subgrade strength, the rigid pavement ACR is 384.

The following table provides ACR data in tabular format. If the ACR for an intermediate weight between maximum taxi weight and the empty weight of the aircraft is required, Figures 7.11.1 through 7.11.8 should be consulted.

AIRCRAFT TYPE	MAXIMUM TAXI WEIGHT ----- MINIMUM WEIGHT *[1] lb (kg)	LOAD ON ONE MAIN GEAR LEG (%)	TIRE PRESSURE psi (MPa)	ACR FOR RIGID PAVEMENT SUBGRADES				ACR FOR FLEXIBLE PAVEMENT SUBGRADES			
				HIGH E = 200 MPa	MEDIUM E = 120 MPa	LOW E = 80 MPa	ULTRA LOW E = 50 MPa	HIGH E = 200 MPa	MEDIUM E = 120 MPa	LOW E = 80 MPa	ULTRA LOW E = 50 MPa
737-7	177,500 (81,512)	46.69	205 (1.41)	510	530	550	570	380	420	460	520
	95,000 (43,091)			240	250	260	270	200	210	220	230
737-8 / -8-200 / BBJ MAX 8	182,700 (82,871)	46.67	212 (1.46)	530	550	570	590	400	430	470	540
	95,000 (43,091)			240	260	270	280	200	210	220	240
737-9 / BBJ MAX 9	195,200 (88,541)	47.07	230 (1.59)	590	610	630	650	440	480	530	600
	95,000 (43,091)			250	260	270	280	210	210	220	240
737-10	198,400 (89,992)	47.22	235 (1.62)	610	630	650	660	460	490	540	610
	95,000 (43,091)			250	270	270	280	210	210	220	240

*[1] Minimum weight used solely as a baseline for ACR curve generation.

7.11.1 Aircraft Classification Rating - Flexible Pavement: Model 737-7

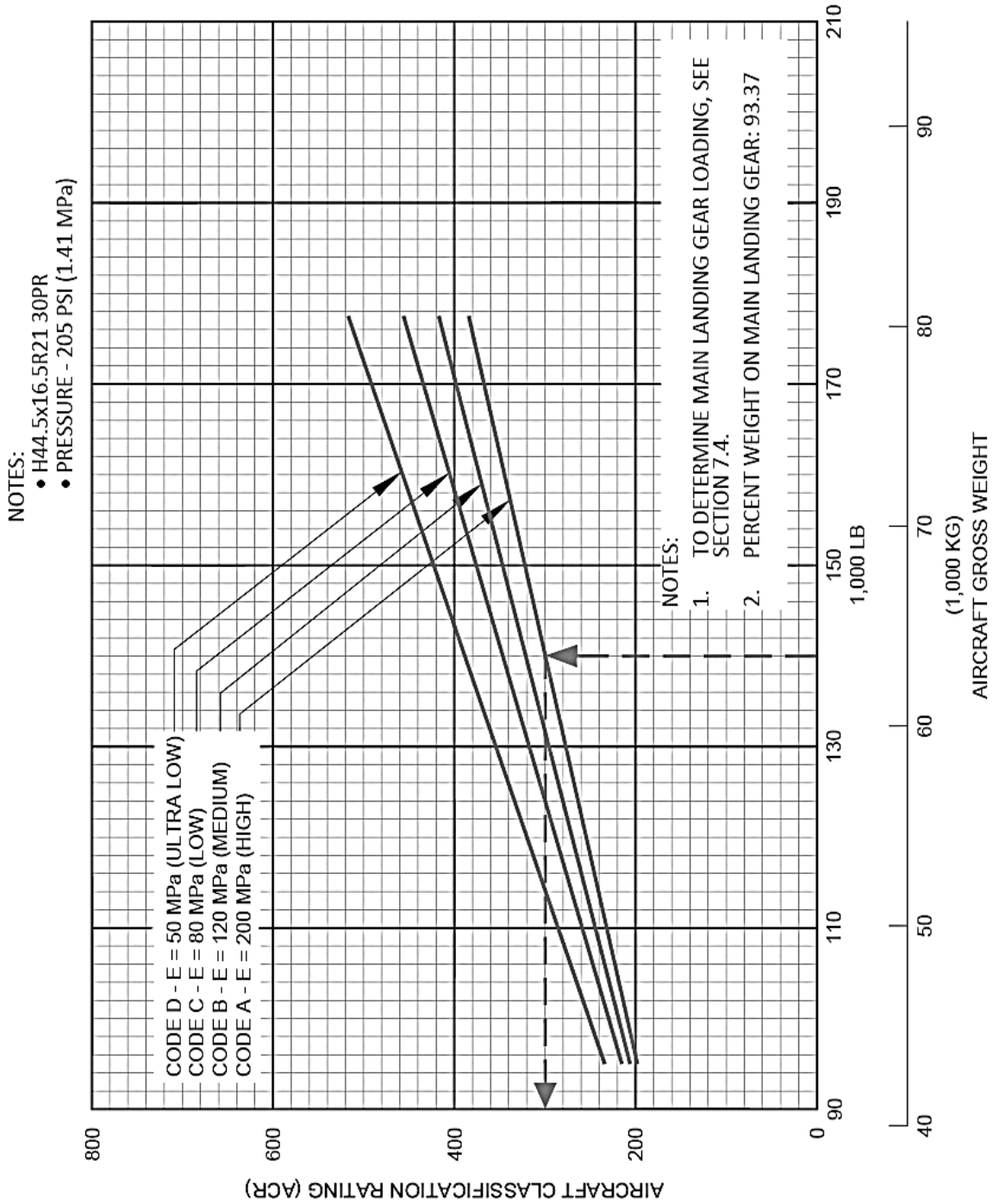

7.11.2 Aircraft Classification Rating - Flexible Pavement: Model 737-8 / -8-200 / BBJ MAX 8

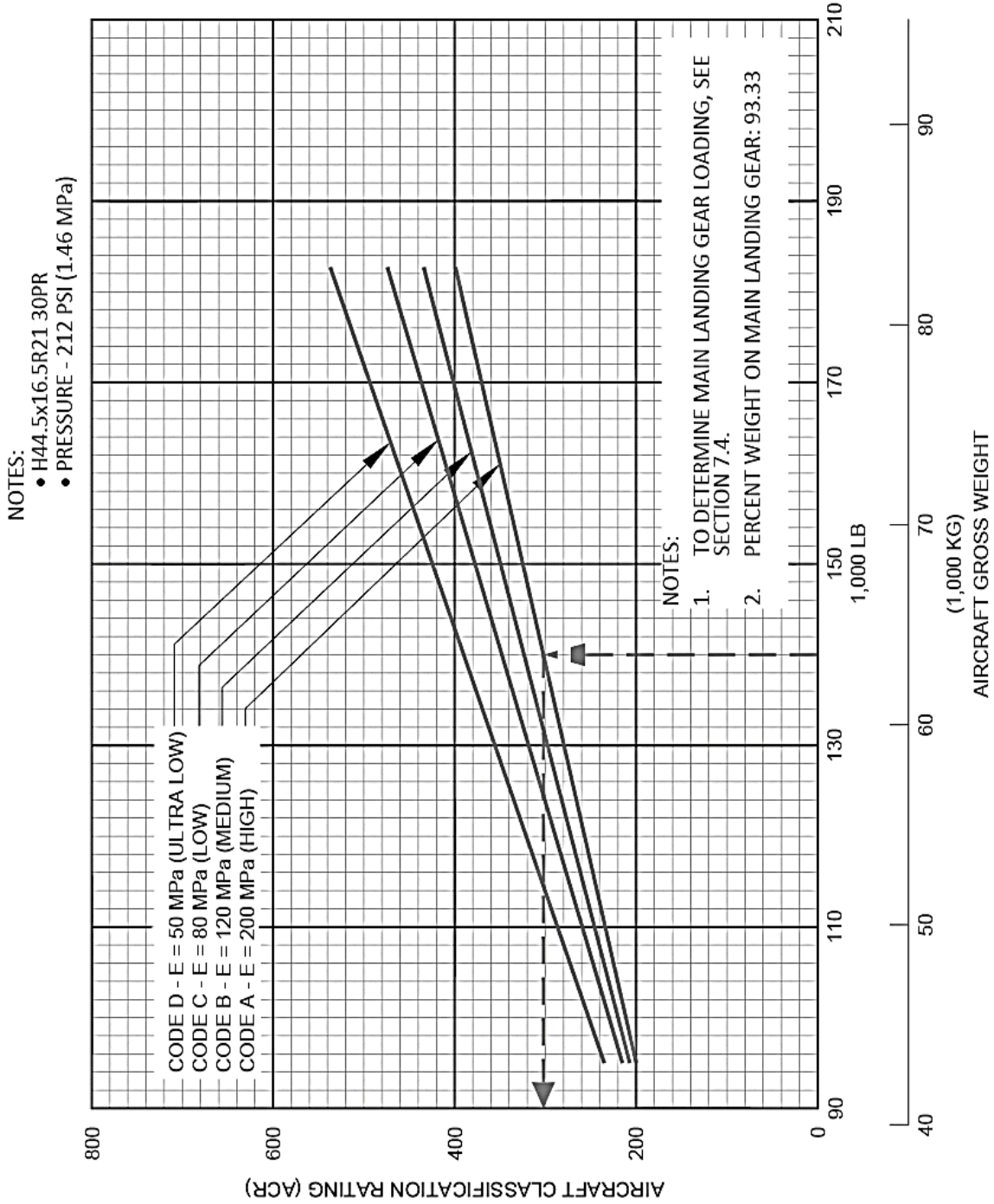

7.11.3 Aircraft Classification Rating - Flexible Pavement: Model 737-9 / BBJ MAX 9

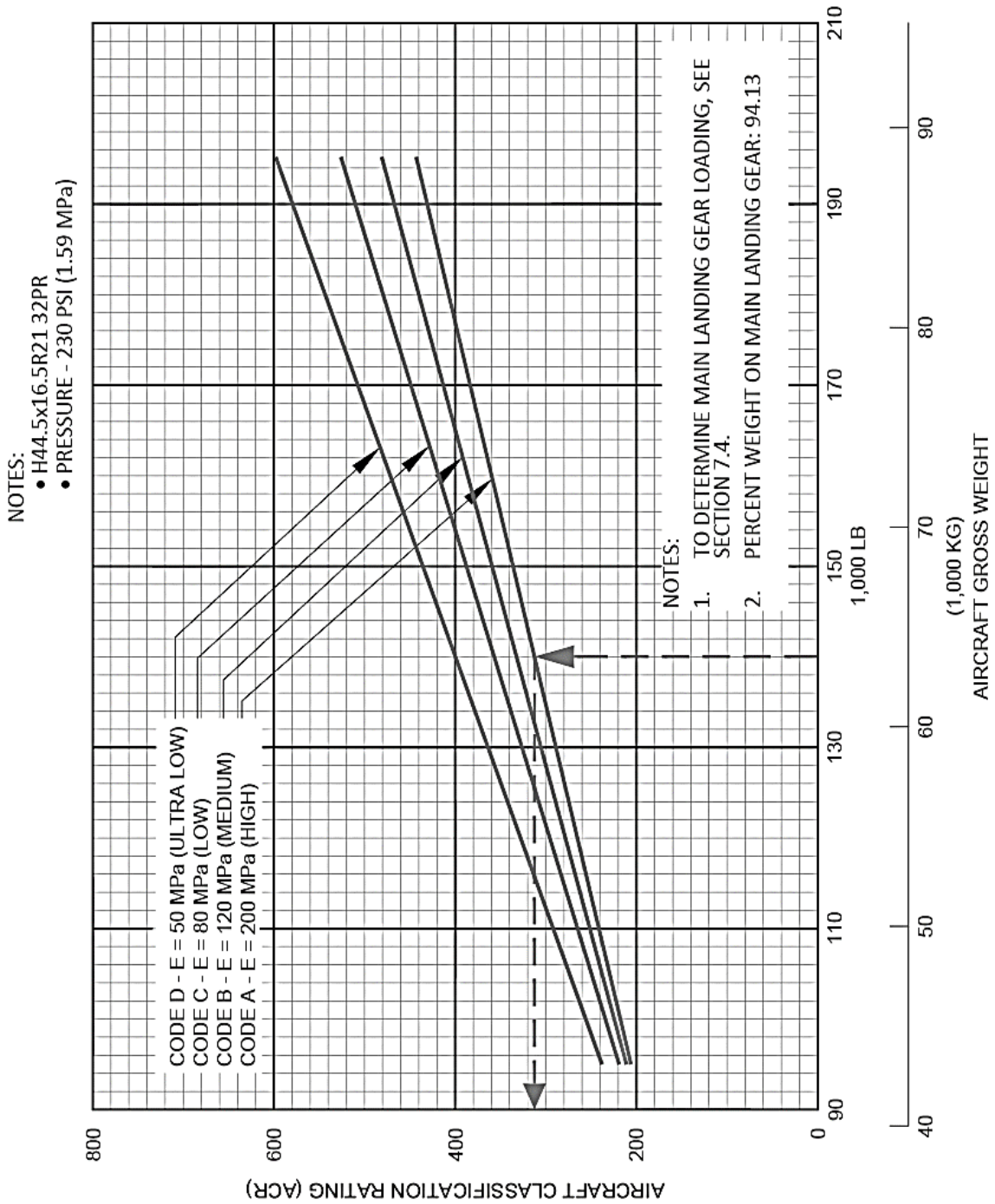

7.11.5 Aircraft Classification Rating - Rigid Pavement: Model 737-7

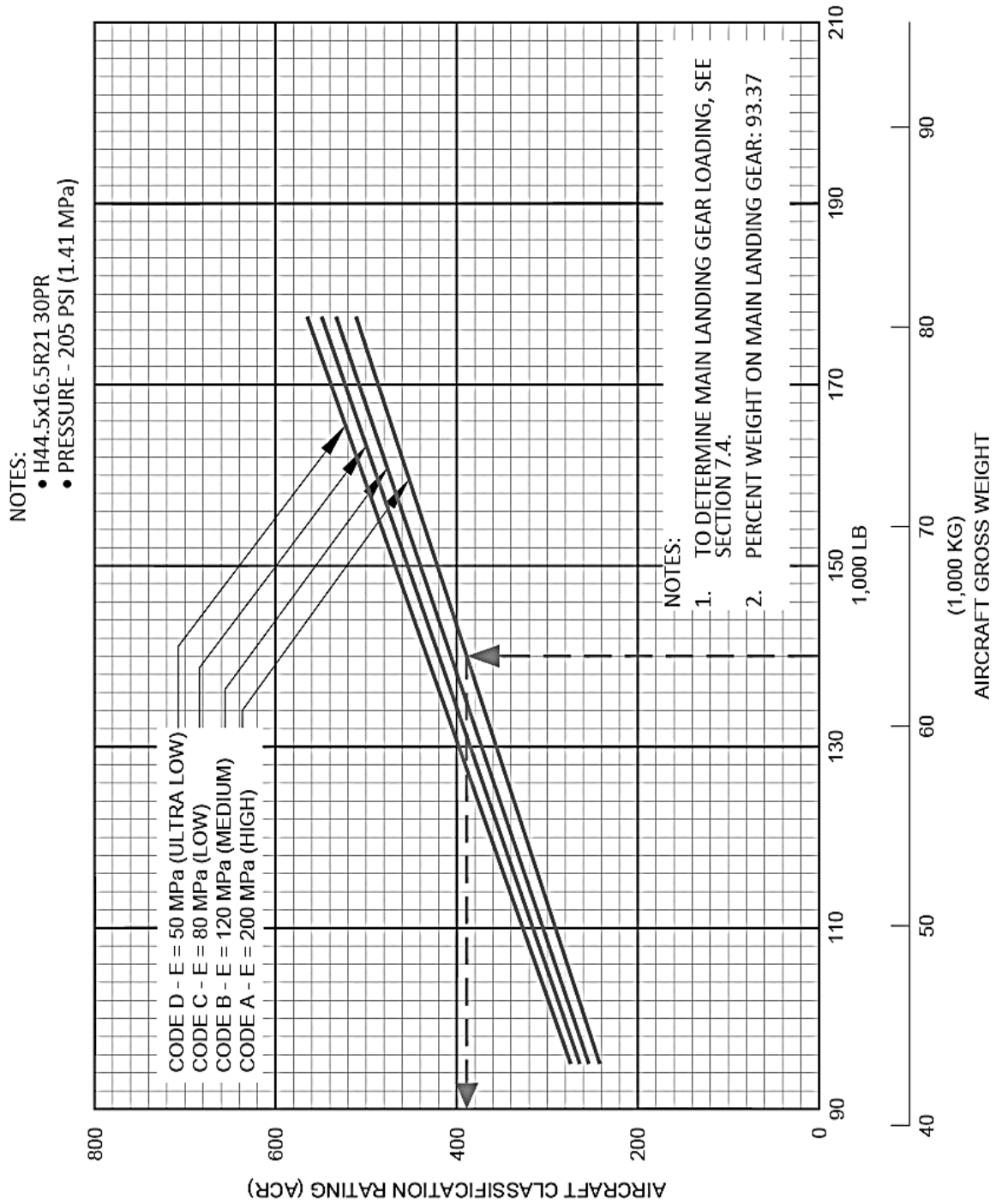

7.11.6 Aircraft Classification Rating - Rigid Pavement: Model 737-8 / -8-200 / BBJ MAX 8

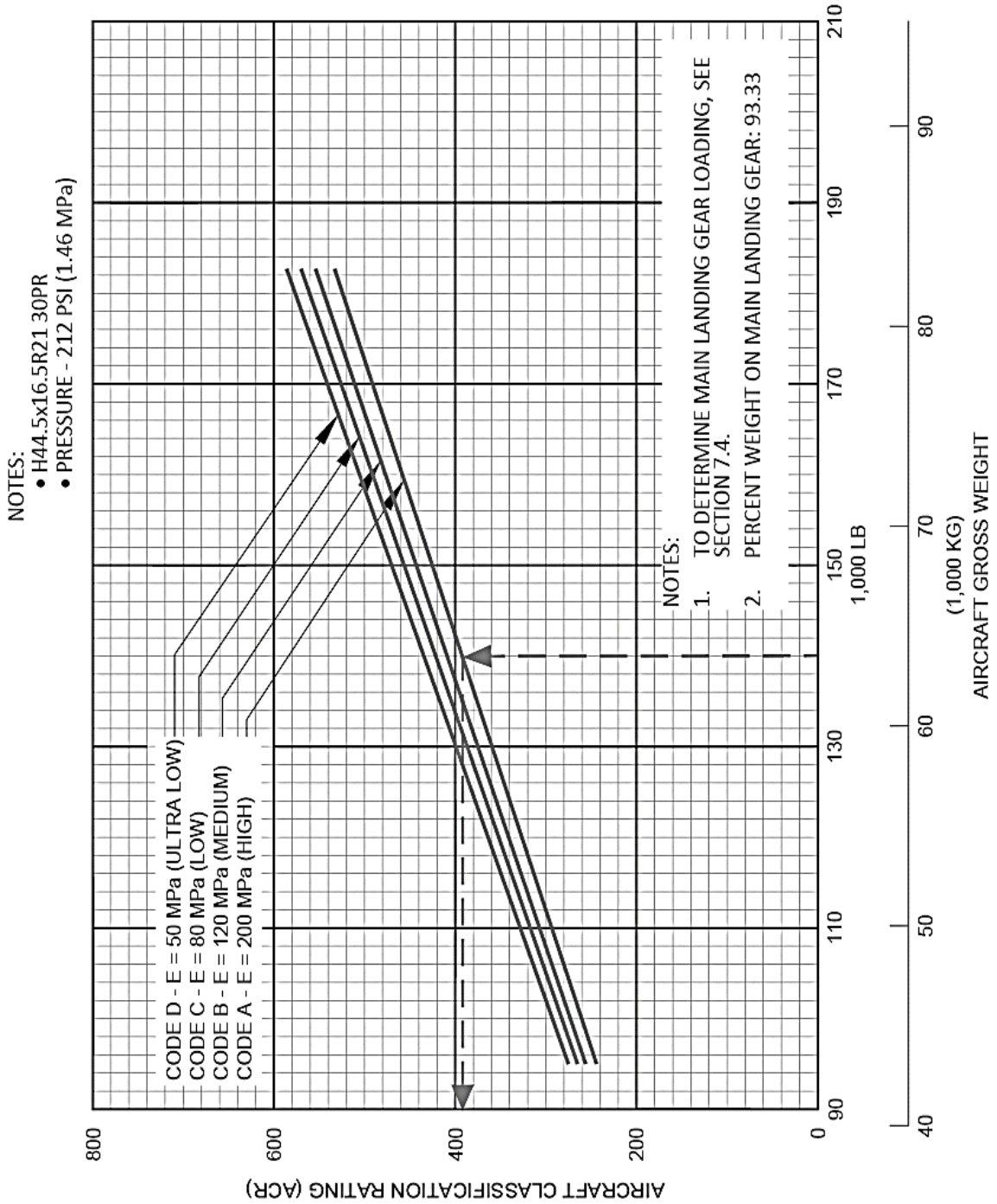

7.11.7 Aircraft Classification Rating - Rigid Pavement: Model 737-9 / BBJ MAX 9

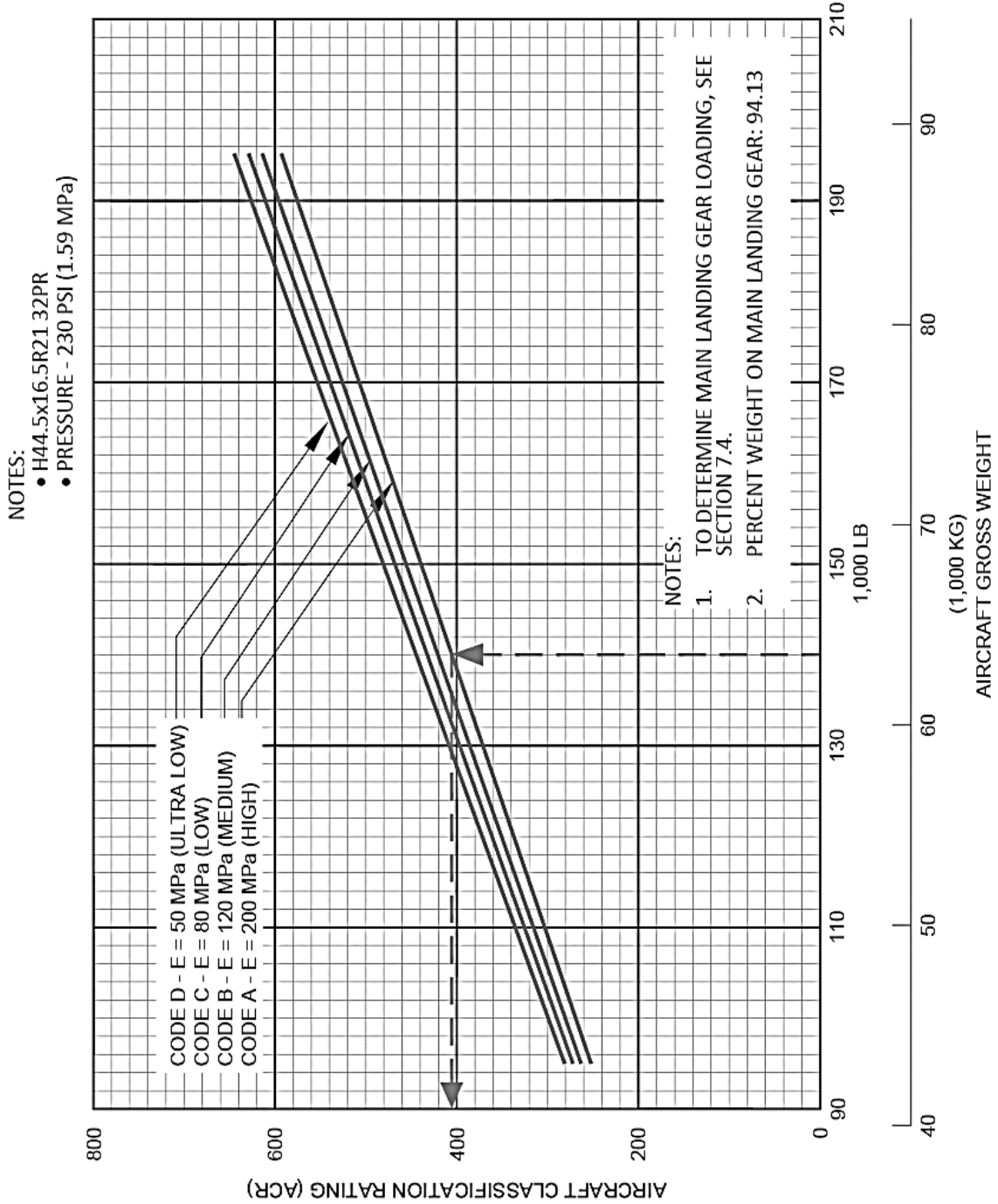

D6-38A004

7.11.8 Aircraft Classification Rating - Rigid Pavement: Model 737-10

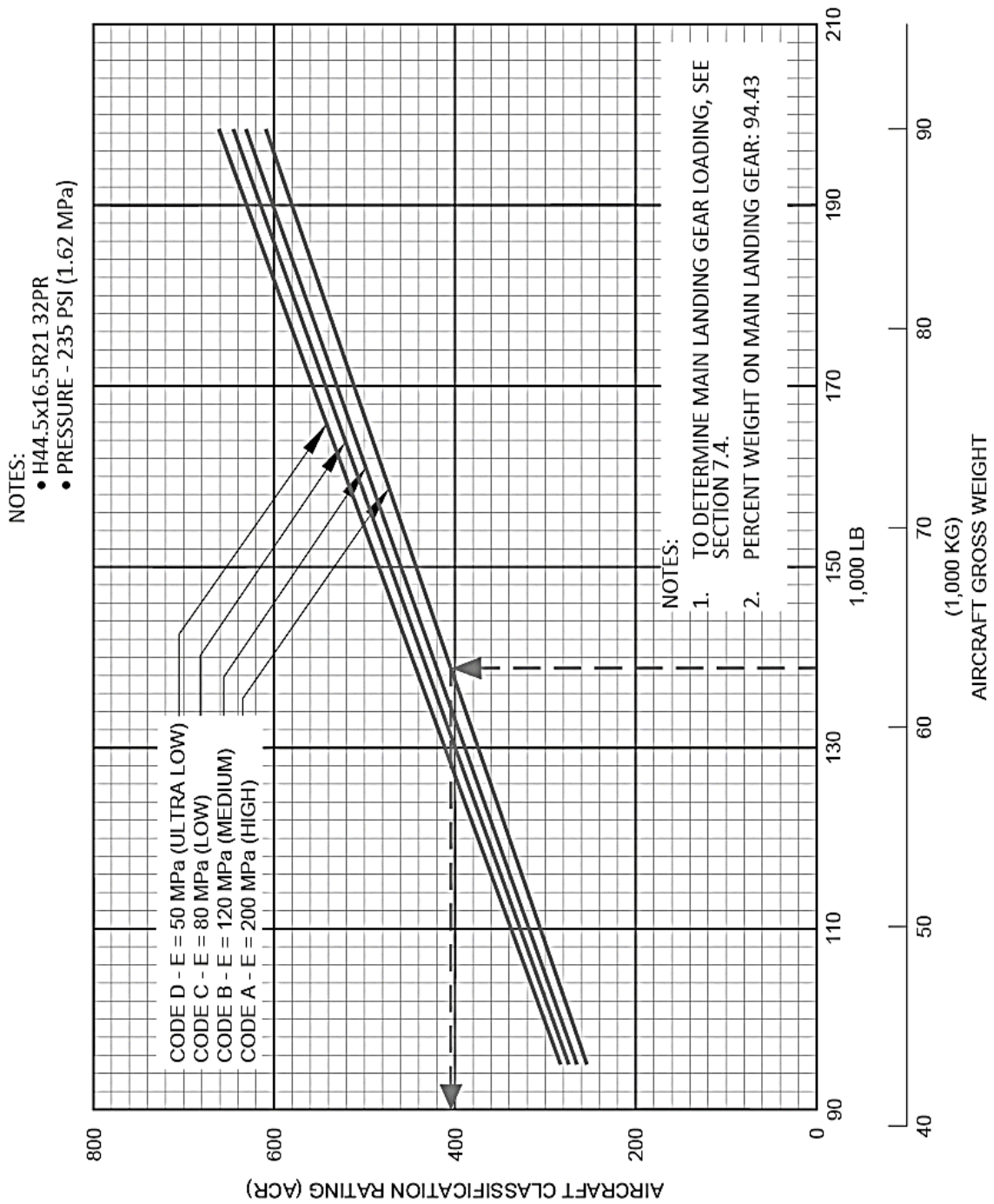

D6-38A004

REV H

March 2023

7-3

8.0 FUTURE 737 DERIVATIVE AIRPLANES

Boeing's philosophy is to evaluate the derivative potential of its airplanes to provide capabilities that maximize value to our customers.

Decisions to design and manufacture future derivatives of an airplane depend on many considerations, including customer requirements. Along with many other parameters, airport facilities are considered during the development of any future airplane.

9.0 SCALED 737 DRAWINGS

The drawings in the following pages show airplane plan view drawings, drawn to approximate scale as noted. The drawings may not come out to exact scale when printed or copied from this document. Printing scale should be adjusted when attempting to reproduce these drawings. Three-view drawing files of the 737 MAX airplane models, along with other Boeing airplane models, can be downloaded from the following website:

<http://www.boeing.com/airports>

9.1 MODEL 737-7

9.1.1 Scaled Drawings – 1:500: Model 737-7

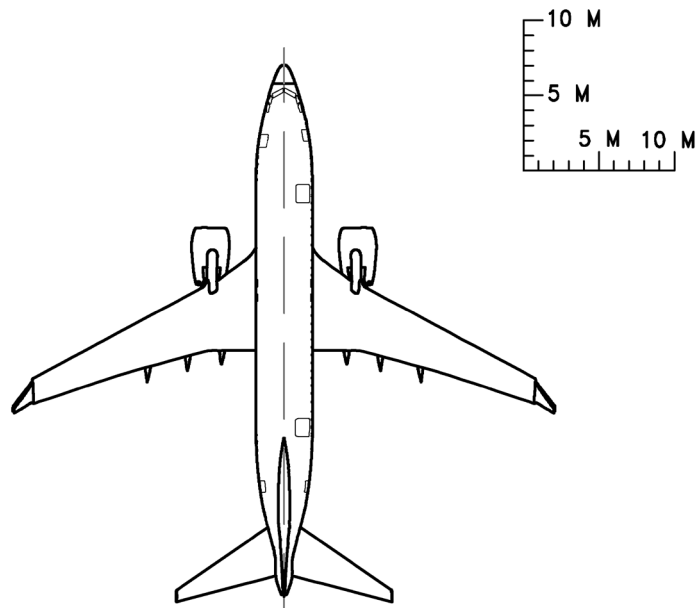

NOTE: WHEN PRINTING THIS DRAWING, MAKE SURE TO ADJUST FOR PROPER SCALING

9.2 MODEL 737-8

9.2.1 Scaled Drawings – 1:500: Model 737-8

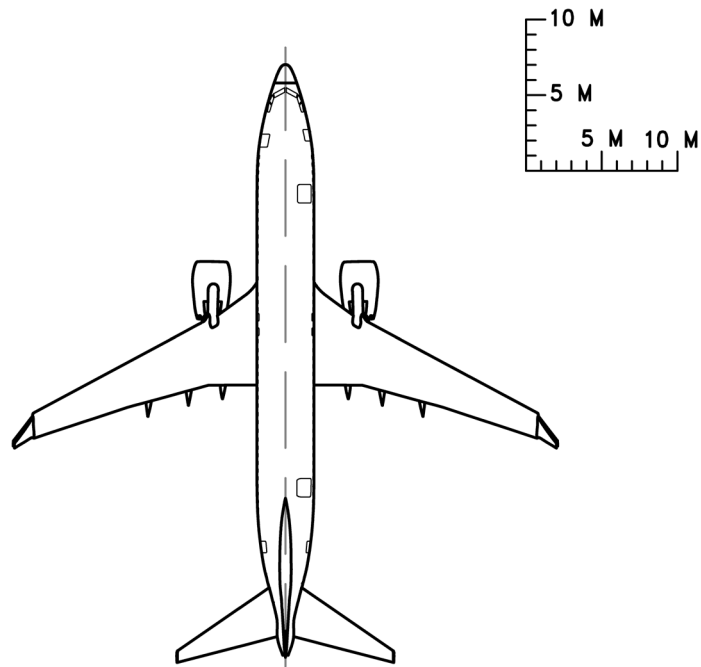

NOTE: WHEN PRINTING THIS DRAWING, MAKE SURE TO ADJUST FOR PROPER SCALING

9.3 MODEL 737-9

9.3.1 Scaled Drawings – 1:500: Model 737-9

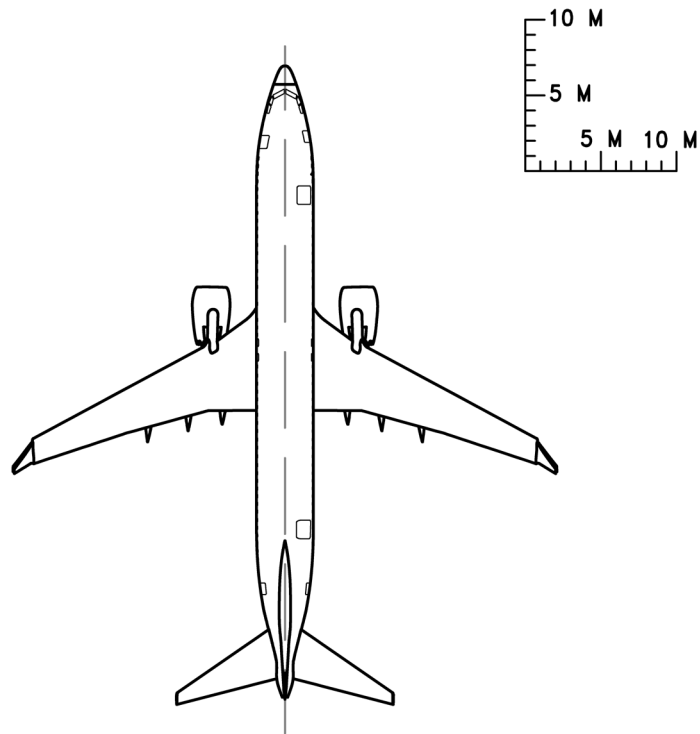

NOTE: WHEN PRINTING THIS DRAWING, MAKE SURE TO ADJUST FOR PROPER SCALING

9.4 MODEL 737-10

9.4.1 Scaled Drawings – 1:500: Model 737-10

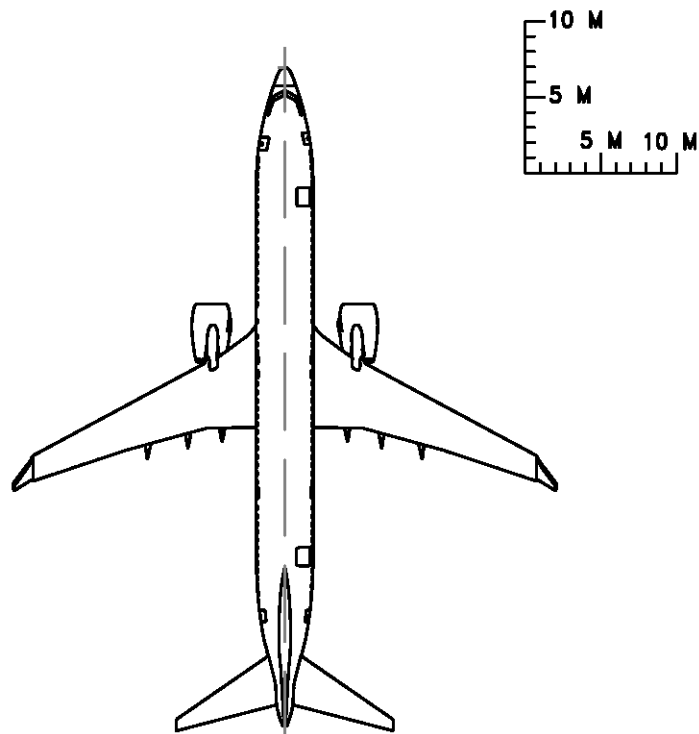

NOTE: WHEN PRINTING THIS DRAWING, MAKE SURE TO ADJUST FOR PROPER SCALING