

747

AIRPLANE CHARACTERISTICS

AIRPORT PLANNING

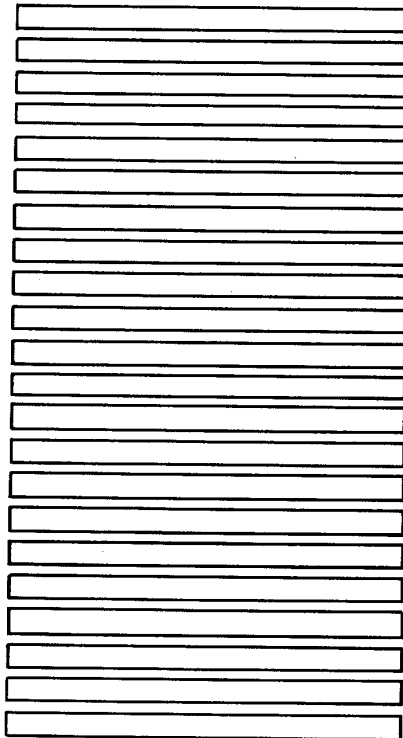

BOEING
COMMERCIAL AIRPLANE COMPANY
(A DIVISION OF THE BOEING COMPANY)

Not Subject to US Export Administration Regulations (EAR), (15 C.F.R. Parts 730-774)
or US International Traffic in Arms Regulations (ITAR), (22 C.F.R. Parts 120-130).

D6-58326

MAY 1984

i

THIS PAGE INTENTIONALLY LEFT BLANK

747 AIRPLANE CHARACTERISTICS

REVISIONS					
Page	Date	Page	Date	Page	Date
Original 1 to 94	March 1968	37	May 1984	85	April 1981
R1 1 to 122	May 1969	38	May 1984	86	May 1984
R2 1 to 133	December 1969	39	May 1984	87	May 1984
R3 1 to 238	August 1975	40	April 1981	88	May 1984
Rev. D 1 to 216	April 1981	41	May 1969	89	May 1984
Rev. E	May 1984	42	May 1984	90	May 1984
1	May 1969	43	May 1984	91	May 1984
2	May 1984	44	April 1981	92	May 1984
3	May 1984	45	May 1984	93	May 1984
4	May 1984	46	May 1984	94	May 1984
5	May 1984	47	May 1984	95	May 1984
6	May 1984	48	April 1981	96	May 1984
7	May 1984	49	May 1984	97	May 1984
8	May 1984	50	May 1984	98	May 1984
9	May 1984	51	May 1984	99	May 1984
10	Blank	52	May 1984	100	May 1984
11	December 1969	53	May 1984	101	May 1984
12	May 1984	54	May 1984	102	April 1981
13	May 1984	55	April 1981	103	April 1981
14	May 1984	56	April 1981	104	May 1984
15	May 1984	57	April 1981	105	May 1984
16	May 1984	58	May 1984	106	December 1969
17	May 1984	59	May 1984	107	May 1984
18	May 1984	60	May 1984	108	May 1984
19	May 1984	61	April 1981	109	May 1984
20	May 1984	62	April 1981	110	May 1984
21	May 1984	63	May 1984	111	May 1984
22	May 1984	64	April 1981	112	May 1984
23	August 1975	65	May 1984	113	May 1984
24	May 1984	66	May 1984	114	May 1984
25	May 1984	67	May 1984	115	May 1984
26	May 1984	68	May 1984	116	May 1984
27	May 1984	69	April 1981	117	August 1975
28	May 1984	70	April 1981	118	August 1975
29	May 1984	71	Blank	119	May 1984
30	May 1984	72	April 1981	120	May 1984
31	May 1984	73	April 1981	121	May 1984
32	May 1984	74	April 1981	122	May 1984
33	May 1984	75	April 1981	123	May 1984
34	May 1984	76	April 1981	124	May 1984
35	May 1984	77	April 1981	125	April 1981
36	May 1984	78	April 1981	126	April 1981
		79	April 1981	127	May 1984
		80	April 1981	128	May 1984
		81	April 1981	129	May 1984
		82	April 1981	130	April 1981
		83	April 1981	131	April 1981
		84	April 1981	132	Blank

**747 AIRPLANE CHARACTERISTICS
REVISIONS (CONTINUED)**

Page	Date	Page	Date	Page	Date
133	April 1981	181	August 1975	229	May 1984
134	May 1984	182	August 1975	230	May 1984
135	May 1984	183	May 1984	231	May 1984
136	May 1984	184	June 2010	232	Blank
137	May 1984	185	May 1984	233	May 1969
138	August 1975	186	May 1984	234	May 1984
139	May 1984	187	May 1984	235	May 1984
140	May 1984	188	May 1984	236	Blank
141	May 1984	189	May 1984	237	May 1984
142	May 1969	190	May 1984	238	Blank
143	May 1984	191	May 1984	239	May 1984
144	May 1984	192	May 1984	240	Blank
145	May 1984	193	May 1984	241	May 1984
146	May 1984	194	May 1984	242	Blank
147	August 1975	195	May 1984	243	May 1984
148	May 1984	196	May 1984	244	Blank
149	May 1984	197	May 1984	245	May 1984
150	May 1984	198	May 1984	246	Blank
151	May 1984	199	May 1984	247	April 1981
152	May 1984	200	May 1984	248	Blank
153	May 1984	201	May 1984	249	April 1981
154	May 1984	202	May 1984	250	Blank
155	August 1975	203	May 1984	251	April 1981
156	August 1975	204	May 1984	252	Blank
157	May 1984	205	May 1984	253	April 1981
158	May 1984	206	May 1984	254	Blank
159	May 1984	207	May 1984	255	April 1981
160	May 1984	208	May 1984	256	Blank
161	May 1984	209	May 1984	3	May 2011
162	August 1975	210	May 1984		
163	May 1984	211	May 1984		
164	May 1984	212	May 1981		
165	August 1975	213	August 1975		
166	August 1975	214	May 1984		
167	August 1975	215	May 1984		
168	August 1975	216	May 1984		
169	May 1969	217	May 1984		
170	May 1984	218	May 1984		
171	May 1984	219	May 1984		
172	May 1984	220	May 1984		
173	May 1984	221	May 1984		
174	May 1984	222	May 1984		
175	May 1984	223	June 2010		
176	May 1984	224	June 2010		
177	May 1984	224A	June 2010		
178	May 1984	225	June 2010		
179	May 1984	226	May 1984		
180	August 1975	227	May 1984		
		228	May 1984		

TABLE OF CONTENTS

<u>SECTION</u>	<u>TITLE</u>	<u>PAGE</u>
1.0	SCOPE AND INTRODUCTION	1
1.1	Scope	2
1.2	Introduction	3
1.3	747 Family Comparison, A Brief Description	4
2.0	AIRPLANE DESCRIPTION	11
2.1	General Characteristics	12
2.2	General Dimensions	22
2.3	Ground Clearances	24
2.4	Interior Arrangements	27
2.5	Cabin Cross Sections	37
2.6	Lower Cargo Compartments	39
2.7	Door Clearances	43
3.0	AIRPLANE PERFORMANCE	55
3.1	General Information	56
3.2	Payload/Range for Long-Range Cruise	57
3.3	F.A.R. Takeoff Runway Length Requirements	72
3.4	F.A.R. Landing Runway Length Requirements	100
4.0	GROUND MANEUVERING	103
4.1	General Information	104
4.2	Turning Radii	107
4.3	Clearance Radii	115
4.4	Visibility From Cockpit in Static Position	119
4.5	Runway and Taxiway Turn Paths	120
4.6	Runway Holding Bay	131
5.0	TERMINAL SERVICING	133
5.1	Airplane Servicing Arrangement (Typical Turnaround)	135
5.2	Terminal Operations (Turnaround Station)	139
5.3	Terminal Operations (En Route Station)	144
5.4	Ground Service Connections	146
5.5	Engine Starting Pneumatic Requirements	154
5.6	Ground Pneumatic Power Requirements	160
5.7	Conditioned Airflow Requirements	163
5.8	Ground Towing Requirements	166

TABLE OF CONTENTS (CONTINUED)

<u>SECTION</u>	<u>TITLE</u>	<u>PAGE</u>
6.0	JET ENGINE WAKE AND NOISE DATA	169
6.1	Jet Engine Exhaust Velocities and Temperatures	170
6.2	Airport and Community Noise	180
7.0	PAVEMENT DATA	183
7.1	General Information	184
7.2	Landing Gear Footprint	188
7.3	Maximum Pavement Loads	191
7.4	Landing Gear Loading on Pavement	193
7.5	Flexible Pavement Requirements - U.S. Army Corps of Engineers Method S-77-1	198
7.6	Flexible Pavement Requirements, LCN Conversion	201
7.7	Rigid Pavement Requirements, Portland Cement Association	207
7.8	Rigid Pavement Requirements, LCN Conversion	212
7.9	Rigid Pavement Requirements, FAA Design Method	220
7.10	ACN/PCN Reporting System	223
8.0	FUTURE 747 DERIVATIVE AIRPLANES	233
9.0	SCALED 747 DRAWINGS	235

1.0 SCOPE AND INTRODUCTION

1.1 Scope

1.2 Introduction

1.3 747 Family Comparison, A Brief Description

1.0 SCOPE AND INTRODUCTION

1.1 Scope

This document provides, in a standardized format, airplane characteristics data for general airport planning. Since operational practices vary among airlines, specific data should be coordinated with the using airlines prior to facility design. The Boeing Commercial Airplane Company should be contacted for any additional information required.

Content of the document reflects the results of a coordinated effort by representatives from the following organizations:

- Aerospace Industries Association
- Airport Operators Council International
- Air Transport Association of America
- International Air Transport Association

The airport planner may also want to consider the information presented in the “CTOL Transport Aircraft, Characteristics, Trends, and Growth Projections,” available from the U.S. AIA, 1725 De Sales Street N.W., Washington, DC 20036, for his long-range planning needs. This document is updated periodically and represents the coordinated efforts of the following organizations regarding future aircraft growth trends:

- International Coordinating Council of Aerospace Industries Associations
- Airport Operators Council International, Inc.
- Air Transport Association of America
- International Air Transport Association

1.2 Introduction

This document conforms to NAS 3601. It provides characteristics of the Boeing Model 747 family of airplanes for airport planners and operators, airlines, architectural and engineering consultant organizations, and other interested industry agencies. Airplane changes and available options may alter model characteristics. The data presented herein reflect typical airplanes in each model category.

For additional information contact:

Boeing Commercial Airplanes
P.O. Box 3707
Seattle, Washington 98124-2207
U.S.A.

Attention: Manager, Airport Technology
Mail Code 20-93
Email: AirportTechnology@boeing.com
Fax: 425-237-2665

1.3 747 Family Comparison, A Brief Description

The Boeing Commercial Airplane Company offers the 747 in various commercial versions as follows:

<u>Model Number</u>	<u>Airplane Configuration</u>
747-100, -100B	Passenger Airplane; 710,000-lb (322,000-kg) to 750,000-lb (340,100-kg) takeoff weight. The -100 is no longer in production.
747-100SR	High-capacity, short-range Passenger Airplane; 520,000-lb (235,800-kg) or 600,000-lb (272,100-kg) takeoff weight.
747-100SF	Special Freighters; Model 747-100's retrofitted to carry an all-cargo load.
747-200	Growth versions of the 747-100; details below.
747-200B	Passenger Airplane; 775,000-lb (351,500-kg) to 833,000-lb (377,800-kg) takeoff weight.
747-200B Combi	Similar to the 747-200B except for a left-side main-deck cargo door, aft of the wing, for loading of palletized or containerized cargo.
747-200C	Similar to the 747-200B except for a nose cargo door and an optional main-deck side cargo door. It is convertible to partial or total cargo configuration.
747-200F	Freighter Airplane; 775,000-lb (351,500-kg) to 833,000-lb (377,800-kg) takeoff weight. It has a nose cargo door and an optional main deck side cargo door.
747-300	The -300 option features an extended upper deck for increased passenger capacity.
747SP	Reduced passenger capacity, special performance version of the 747-100 Passenger Airplane with 630,000-lb (285,700-kg) to 696,000-lb (315,600-kg) takeoff weight.

747-100, -100B

The earlier 747-100s used Pratt & Whitney JT9D-3A engines with 43,500-lb (19,730-kg) thrust each while later versions used the JT9D-3AW engines with increased thrust. The 747-100s were developed to take advantage of the airplane's structural capability as determined in static structural tests. New engines with higher thrusts also became available, and the maximum ramp weight was increased. These changes make possible operation with longer range, greater payload, or combination of the two.

747-100B SR

The SR (short range) option to the 747-100B is designed specifically to fill the need for a high-capacity transport on short routes. This airplane is structurally strengthened to permit twice as many landings in 20 years of short-range flights, yet retain its long-range capability. Interior arrangement allows for more seats and fewer galleys.

747-100SF

The SF (special freighter) airplane is an earlier 747-100 passenger airplane retrofitted to carry an all-cargo payload. Retrofit includes installation of a main-deck side cargo door and associated cargo handling mechanism. Also floor deck structure is strengthened to carry the additional load. The -100SF has virtually the same cargo space as the -200F.

747-200B

The 833,000-lb (377,800-kg) maximum-takeoff-weight airplane can carry 452 passengers in a mixed-class configuration more than 5,500 nmi nonstop. It is powered by advanced JT9D-7 engine derivatives, General Electric CF6-50, or Rolls-Royce RB211-524 engines with rated thrusts to 54,000 lb (24,490 kg).

747-200B Combi

The Combi airplane has the same characteristics as the 747-200B, except the Combi has a main-deck side cargo door installed on the left side, aft of the wing, for loading palletized or containerized cargo. The Combi can be converted to either an all-passenger or a passenger/cargo configuration. In the latter configuration, cargo is in the aft fuselage and is either 6 or 12 cargo modules. An optional 7th or 13th cargo module location is also available. Other cargo module combinations can be loaded compatible with size limits and operational procedures. The Combi is not convertible to an all-cargo configuration.

747-200C

The 747-200C is convertible to all-passenger, all-cargo, or one of several passenger/cargo configurations. In the passenger configuration, the 747-200C is capable of carrying passengers in the same spacious interior as that in the 747-200B. In the cargo configuration, the 747-200C functions as a main-deck cargo carrier virtually equivalent in capability to the 747-200F. Like the 747-200F, the 747-200C has a main-deck nose door for straight-in cargo loading. An optional main-deck side-cargo door allows for loading dimensionally taller cargo modules. In the passenger/cargo configuration, the passengers are in the aft fuselage.

747-200F

The 747-200F freighter has a main-deck nose door and a mechanized cargo-handling system on the main deck. The nose swings up so that pallets or containers, in lengths to 40 ft (12.19m), can be loaded straight in on motor-driven rollers. Two men, one at the nose door control and one inside the airplane, can complete the unload-and-load cycle in about 30 minutes. An optional main-deck side-cargo door allows for loading dimensionally taller cargo modules.

747-300, -300 SR, -300 Combi

The 747-300 features an extended upper deck to provide additional passenger capacity. The -300 also features aft-facing stairs aft of the No. 2 door for access to the upper deck. Two full-size doors on the upper deck provide emergency exit for the upper deck passengers. The -300 option is available on new airplanes as well as for retrofit on existing -100B, -200B, and Combi airplanes.

747SP

The 747SP (special performance) airplane is 48 ft 5 in. (14.78m) shorter than the standard 747 airplane. It can fly higher, faster, and farther than any wide-body aircraft, and as a result serves well on long-distance air routes that do not require airplanes the size of the standard 747. A high degree of parts commonality exists between the 747SP and the 747.

Main-Deck Side Cargo Door

An optional main-deck cargo door is available on the 747 (except SP). Designed for new airplanes as well as for retrofit on 747s now in service, the cargo door is located aft of the wing on the main deck between the fourth and fifth passenger doors on the left side. If installed on passenger aircraft, containerized or palletized cargo can be loaded in the aft fuselage during periods of light passenger traffic. A ball-transfer floor panel, cargo roller tracks and tiedowns, and cabin divider for passenger/cargo combination loads complete the installation.

If installed on the freighter, dimensionally taller loads (e.g., IATA type 2H containers) can be loaded. These containers cannot be loaded through the nose cargo door.

Several 747-100 airplanes have been retrofitted to incorporate the side cargo door for freighter applications. These airplanes have been redesignated as 747-100SF (special freighter).

Upper Deck Seating

The basic seating arrangement in the upper deck can accommodate 32 economy-class seats. The seating arrangement can be increased to 45 economy-class seats with a forward-facing straight-stair option. The -300 airplane with the stretched upper deck and aft-facing straight stairs can accommodate up to 85 seats in an all economy arrangement.

Number 3 Door Deactivation

Another option on the 747 (except SP) is the deactivation of the number 3 doors. This allows space for an additional 12 passenger seats without altering the galley configuration. Full-height storage closets could be installed instead of the additional 12 seats.

Engine and Ramp Weight Combinations

Power for the 747 aircraft can be selected from a wide variety of engines. The following table shows engine choices for corresponding models and ramp weights.

Document Page Applicability

Pages in this document titled “Model 747” are applicable to all Model 747 airplanes.

Pages titled “Model 747-100B” are also applicable to airplanes with the SR option.

Pages titled “Model 747-100” are applicable to the earlier Model 747-100 airplanes.

Pages titled “Model 747-200” are applicable to 747-200B, 747-200C, and 747-200F airplanes.

Pages titled “Model 747-200B” are also applicable to airplanes with the Combi option.

Pages titled “Model 747-300” are also applicable to -100B and -200B airplanes retrofitted to the -300 configuration.

Pages uniquely applicable to a specific model or group of models are so marked.

		MAXIMUM RAMP WEIGHT — 1,000 LB (1,000 KG)				
ENGINE (4 EACH)	THRUST PER ENGINE	747-100, -100B -100SF	747-100B SR	747SP	747-200	747-300
JT9D-3A	43,500 LB (19,730 KG)	713 (323.4) 738 (334.7)				
JT9D-3AW	45,000 LB (20,400 KG)					
JT9D-7A JT9D-7AH	46,950 LB (21,290 KG)	713 (323.4) 738 (334.7) 753 (341.5)	523 (237.2) 573 (259.9) 603 (273.5) 613 (278.0)	636 (268.4) 666 (302.0) 676 (306.6) 696 (315.6) 703 (318.8)	778 (352.8) 788 (357.4)	
JT9D-7AW	48,570 LB (22,030 KG)			FOR-7AW & 7FW: 641 (290.7) 671 (304.3) 681 (308.8) 701 (317.9) 708 (321.1)		
JT9D-7F	48,000 LB (21,770 KG)			778 (352.8) 788 (357.4) 808 (366.4)		
JT9D-7FW	50,000 LB (22,680 KG)			778 (352.8) 788 (357.4) 803 (364.2)		
JT9D-7J	50,000 LB (22,680 KG)			778 (352.8) 788 (357.4) 803 (364.2)		
JT9D-7Q JT9D-70A	53,000 LB (24,040 KG)					
JT9D-7R4G2	54,000 LB (24,490 KG)				778 (352.8) 788 (357.4) 803 (364.2) 823 (373.2) 836 (379.1)	
RB211-524D4	53,100 LB (24,090 KG)					
RB211-524B2	50,100 LB (22,720 KG)	713 (323.4) 738 (334.7) 753 (341.5)	523 (237.2) 574 (260.3) 603 (273.5)	636 (288.4) 666 (302.0) 676 (306.6) 696 (325.6) 703 (318.8)		
RB211-524C2	51,500 LB (23,360 KG)					
CF6-45A CF6-45A2/B2 CF6-50E2-F	46,500 LB (21,090 KG)					
CF6-50E/E1 CF6-50E2 ①	52,500 LB (23,810 KG)				778 (352.8) 788 (357.4) 803 (364.2) 823 (373.2) 836 (379.1)	778 (352.8) 788 (357.4) 803 (364.2) 823 (373.2) 836 (379.1)

NOTES:

- RAMP WEIGHTS SHOWN ARE STANDARD AIRPLANE WEIGHTS AS OFFERED. DELIVERED AIRPLANES MAY HAVE DIFFERENT RAMP WEIGHTS. CONSULT WITH AIRLINE FOR ACTUAL ENGINE/WEIGHT COMBINATION.
- 747-300 WEIGHTS REFLECT NEW AIRPLANE CONFIGURATIONS. RETROFIT AIRPLANES MAY RETAIN EXISTING ENGINE/WEIGHT COMBINATION.
- SEE SECTION 2.1 GENERAL CHARACTERISTICS FOR DETAILS ON SELECTED COMBINATIONS.

① CF6-50E/E1 NOT APPLICABLE ON 747-300

1.3.1 BRIEF DESCRIPTION AND COMPARISON—ENGINE/WEIGHT COMBINATIONS MODEL 747

THIS PAGE INTENTIONALLY LEFT BLANK

- 2.0 AIRPLANE DESCRIPTION**
 - 2.1 General Characteristics**
 - 2.2 General Dimensions**
 - 2.3 Ground Clearances**
 - 2.4 Interior Arrangements**
 - 2.5 Cabin Cross Sections**
 - 2.6 Lower Cargo Compartments**
 - 2.7 Door Clearances**

2.0 AIRPLANE DESCRIPTION

2.1 General Characteristics

Maximum Design Taxi Weight (MTW). Maximum weight for ground maneuver as limited by aircraft strength and airworthiness requirements. (It includes weight of taxi and runup fuel.)

Maximum Design Landing Weight (MLW). Maximum weight for landing as limited by aircraft strength and airworthiness requirements.

Maximum Design Takeoff Weight (MTOW). Maximum weight for takeoff as limited by aircraft strength and airworthiness requirements. (This is the maximum weight at start of the takeoff run.)

Operating Empty Weight (OEW). Weight of structure, powerplant, furnishing systems, unusable fuel and other unusable propulsion agents, and other items of equipment that are considered an integral part of a particular airplane configuration. Also included are certain standard items, personnel, equipment, and supplies necessary for full operations, excluding usable fuel and payload.

Maximum Design Zero Fuel Weight (MZFW). Maximum weight allowed before usable fuel and other specified usable agents must be loaded in defined sections of the aircraft as limited by strength and airworthiness requirements.

Maximum Payload. Maximum design zero fuel weight minus operational empty weight.

Maximum Seating Capacity. The maximum number of passengers specifically certified or anticipated for certification.

Maximum Cargo Volume. The maximum space available for cargo.

Usable Fuel. Fuel available for aircraft propulsion.

CHARACTERISTIC		ENGINE UNITS ①	747-100				
			747-100/100B	747-100SF	747-100B SR		
MAXIMUM RAMP WEIGHT			JT9D-3A -3AW	RB211- 524C2	JT9D-7A -7AW -7AH	CF6-45A2	JT9D-7A
		POUNDS	713,000	753,000	738,000	574,000	603,000
		KILOGRAMS	323,400	341,500	334,700	260,320	273,500
MAXIMUM LANDING WEIGHT			564,000	585,000	564,000 ②	564,000	564,000
		POUNDS	255,800	265,300	255,800 ②	255,800	255,800
		KILOGRAMS	710,000	750,000	735,000	571,000	600,000
MAXIMUM TAKEOFF OR BRAKE RELEASE WEIGHT			322,100	340,100	333,300	258,960	272,100
		POUNDS	358,000	378,910	381,480	362,750	359,180
		KILOGRAMS	162,500	171,840	173,010	164,510	162,890
ZERO FUEL WEIGHT			526,500	545,000	526,500	475,000	485,000
		KILOGRAMS	238,780	247,170	238,780	215,420	219,950
MAXIMUM STRUCTURAL PAYLOAD			168,500	166,090	145,020	112,240	125,820
		POUNDS	76,280	75,330	65,770	50,910	57,060
		KILOGRAMS					
MAXIMUM SEATING CAPACITY (INCLUDES 32 SEATS ON OPTION- AL UPPER DECK)			452	452	—	—	—
		BASIC MIXED ARRANGEMENT (INCLUDES 32 FIRST-CLASS SEATS)					
		ALTERNATE ARRANGEMENT ALL-ECONOMY (10 ABREAST)	480	480	—	550 ③	550 ③
MAXIMUM LOWER-LOBE & MAIN DECK CONTAINERIZED CARGO VOLUME			5,250	5,250	23,520 ④	5,250	5,250
		CUBIC FEET	150	150	666 ④	150	150
		CUBIC METERS	1,000	1,000	1,000	1,000	1,000
MAXIMUM LOWER-LOBE BULK CARGO VOLUME			28	28	28	28	28
		CUBIC METERS	47,210	48,070	48,445	48,445	48,445
		U.S. GALLONS	178,700	181,950	183,360	183,360	183,360
USABLE FUEL CAPACITY			316,300	322,070	324,580	324,580	324,580
		LITERS	143,475	146,085	147,215	147,215	147,215
		POUNDS					
		KILOGRAMS					
ENGINE INJECTION WATER CAPACITY			400 ⑤	—	700 ⑥	—	—
		U.S. GALLONS	1,510 ⑤	—	2,650 ⑥	—	—
		LITERS					

- ① TYPICAL ENGINE/WEIGHT COMBINATIONS SHOWN. SEE SEC. 1.3 FOR OTHER COMBINATIONS.
- ② OPTIONAL LANDING WEIGHT OF 585,000 LB (265,300 KG) IS AVAILABLE.
- ③ 37 SEATS ON UPPER DECK.
- ④ INCLUDES 29 MAIN DECK CONTAINERS 96 BY 125 BY 96 IN. (2.44 BY 3.18 BY 2.44M).
- ⑤ JT9D-3AW ENGINES.
- ⑥ JT9D-7AW ENGINES.

2.1.1 GENERAL CHARACTERISTICS MODEL 747-100

BASIC ALL-PASSENGER CONFIGURATION

CHARACTERISTIC	ENGINE ①		JT9D-7AW	JT9D-7J	CF6-50E2	RB211-524D4	JT9D-7R4G2
	UNITS						
MAXIMUM RAMP WEIGHT	POUNDS		778,000	788,000	803,000	823,000	836,000
	KILOGRAMS		352,800	357,400	364,200	373,200	379,100
MAXIMUM LANDING WEIGHT ②	POUNDS		564,000	564,000	585,000	630,000	630,000
	KILOGRAMS		255,800	255,800	265,300	285,700	285,700
MAXIMUM TAKEOFF OR BRAKE RELEASE WEIGHT	POUNDS		775,000	785,000	800,000	823,000	833,000
	KILOGRAMS		351,500	356,000	362,800	371,900	377,800
OPERATING EMPTY WEIGHT (TYPICAL—VARIES WITH ENGINE/WEIGHT OPTION)	POUNDS		381,150	380,510	381,810	388,010	376,170
	KILOGRAMS		172,860	172,570	173,160	175,970	170,600
ZERO FUEL WEIGHT	POUNDS		526,500	526,500	526,500	526,500	526,500
	KILOGRAMS		238,780	238,780	238,780	238,780	238,780
MAXIMUM STRUCTURAL PAYLOAD	POUNDS		145,350	145,990	144,690	138,490	150,330
	KILOGRAMS		65,920	66,210	65,620	62,810	68,180
MAXIMUM SEATING CAPACITY (INCLUDES 32 SEATS ON OPTIONAL UPPER DECK)	BASIC MIXED ARRANGEMENT (INCLUDES 32 FIRST-CLASS SEATS)		452	452	452	452	452
	ALTERNATE ARRANGEMENT ALL-ECONOMY (10 ABREAST)		480	480	480	480	480
MAXIMUM LOWER-LOBE & MAIN DECK CONTAINERIZED CARGO VOLUME	CUBIC FEET		5,250	5,250	5,250	5,250	5,250
	CUBIC METERS		150	150	150	150	150
MAXIMUM LOWER-LOBE BULK CARGO VOLUME	CUBIC FEET		1,000	1,000	1,000	1,000	1,000
	CUBIC METERS		28	28	28	28	28
USABLE FUEL CAPACITY ③	U.S. GALLONS		52,410	52,410	52,035	52,410	52,410
	LITERS		198,370	198,370	196,950	198,370	198,370
	POUNDS		351,150	351,150	348,635	351,150	351,150
	KILOGRAMS		159,250	159,250	158,110	159,250	159,250

① TYPICAL ENGINE/WEIGHT COMBINATIONS SHOWN.

② SEE SEC. 1.3 FOR OTHER COMBINATIONS AVAILABLE.

③ 585,000 LB (265,300 KG) AND 630,000 LB (285,700 KG) ARE OPTIONAL LANDING WEIGHTS.

④ EXTENDED RANGE FUEL (1,576 GAL/5,965 L) IS AVAILABLE WITH OEW INCREASE OF 160 LB (73 KG).

2.1.2 GENERAL CHARACTERISTICS

MODEL 747-200B

747-200B COMBI						
CHARACTERISTIC	ENGINE ①	ALL-PASSENGER		6-PALLET	7-PALLET	12-PALLET
		UNITS	JT9D-7F			
MAXIMUM RAMP WEIGHT	POUNDS	778,000	788,000	803,000	823,000	836,000
	KILOGRAMS	352,800	357,400	364,200	373,200	379,100
MAXIMUM LANDING WEIGHT	POUNDS	585,000 ②	630,000	630,000	630,000	630,000
	KILOGRAMS	265,300 ②	285,700	285,700	285,700	285,700
MAXIMUM TAKEOFF OR BRAKE RELEASE WEIGHT	POUNDS	775,000	785,000	800,000	820,000	833,000
	KILOGRAMS	351,500	356,000	362,800	371,900	377,800
OPERATING EMPTY WEIGHT (TYPICAL— VARIES WITH ENGINE/WEIGHT OPTION)	POUNDS	387,080	387,580	385,910	391,600	376,120
	KILOGRAMS	175,550	175,770	175,020	177,600	170,580
ZERO FUEL WEIGHT	POUNDS	545,000	545,000	545,000	545,000	545,000
	KILOGRAMS	247,170	247,170	247,170	247,170	247,170
MAXIMUM STRUCTURAL PAYLOAD	POUNDS	157,920	157,420	159,090	153,400	158,880
	KILOGRAMS	71,620	71,400	72,150	69,570	72,050
MAXIMUM SEATING CAPACITY (INCLUDES 32 SEATS ON OPTION- AL UPPER DECK)	BASIC MIXED ARRANGEMENT (INCLUDES 32 FIRST-CLASS SEATS)	452	452	316	316	238
	ALTERNATE ARRANGEMENT ALL-ECONOMY (10 ABREAST)	480	480	344	344	266
MAXIMUM LOWER-LOBE & MAIN DECK CONTAINERIZED CARGO VOLUME	CUBIC FEET	5,250	5,250	9,030 ③	9,660 ④	12,810 ⑤
	CUBIC METERS	150	150	260 ③	270 ④	360 ⑤
MAXIMUM LOWER-LOBE BULK CARGO VOLUME	CUBIC FEET	1,000	1,000	1,000	1,000	1,000
	CUBIC METERS	28	28	28	28	28
USABLE FUEL CAPACITY ⑥	U.S. GALLONS	52,410	52,410	52,035	52,410	52,410
	LITERS	198,370	198,370	196,950	198,370	198,370
	POUNDS	351,150	351,150	348,635	351,150	351,150
	KILOGRAMS	159,250	159,250	158,110	159,250	159,250

- ① TYPICAL ENGINE/WEIGHT COMBINATIONS SHOWN. SEE SEC. 1.3 FOR OTHER COMBINATIONS AVAILABLE.
- ② OPTIONAL LANDING WEIGHT OF 630,000 LB (285,700 KG) IS AVAILABLE.
- ③ INCLUDES SIX 96 BY 125 BY 96 IN. (2.44 BY 3.18 BY 2.44 M) PALLETIZED CARGO MODULES.
- ④ INCLUDES SEVEN 96 BY 125 BY 96 IN. PALLETIZED CARGO MODULES.
- ⑤ INCLUDES TWELVE 96 BY 125 BY 96 IN. PALLETIZED CARGO MODULES.
- ⑥ EXTENDED RANGE FUEL (1,576 GAL/5,965 L) IS AVAILABLE WITH OEW INCREASE OF 160 LB (73 KG).

2.1.3 GENERAL CHARACTERISTICS
MODEL 747-200B COMBI

CHARACTERISTIC		ENGINE ^①		ALL PASSENGER		ALL CARGO	
		UNITS		JT9D-7AW	JT9D-7FW	CF6-50E2	JT9D-7Q
MAXIMUM RAMP WEIGHT	POUNDS	778,000	803,000	788,000	823,000	836,000	
	KILOGRAMS	352,800	364,200	357,400	373,200	379,100	
MAXIMUM LANDING WEIGHT	POUNDS	630,000	630,000	630,000	630,000	630,000	
	KILOGRAMS	285,700	285,700	285,700	285,700	285,700	
MAXIMUM TAKEOFF OR BRAKE RELEASE WEIGHT	POUNDS	775,000	800,000	785,000	820,000	833,000	
	KILOGRAMS	351,500	362,800	356,000	371,900	377,800	
OPERATING EMPTY WEIGHT (TYPICAL ^② VARIES WITH ENGINE/WEIGHT OPTION)	POUNDS	390,730	390,740	361,680	367,620	393,890	
	KILOGRAMS	177,200	177,210	164,030	166,720	178,640	
ZERO FUEL WEIGHT	POUNDS	590,000	590,000	590,000	590,000	590,000	
	KILOGRAMS	267,570	267,570	267,570	267,570	267,570	
MAXIMUM STRUCTURAL PAYLOAD ^③	POUNDS	199,270	199,260	228,320	222,380	196,110	
	KILOGRAMS	90,370	90,360	130,340	100,850	88,930	
MAXIMUM SEATING CAPACITY (INCLUDES 32 SEATS ON OPTIONAL UPPER DECK)	BASIC MIXED ARRANGEMENT (INCLUDES 32 FIRST-CLASS SEATS)	452	452	—	—	—	
	ALL-ECONOMY (9 ABREAST)	432	432	—	—	—	
	ALL-ECONOMY (10 ABREAST)	480	480	—	—	—	
MAXIMUM LOWER-LOBE & MAIN DECK CONTAINERIZED CARGO VOLUME	CUBIC FEET	5,250	5,250	23,520 ^④	23,520 ^④	23,520 ^④	
	CUBIC METERS	150	150	666 ^④	666 ^④	666 ^④	
MAXIMUM LOWER-LOBE BULK CARGO VOLUME	CUBIC FEET	800	800	800	800	800	
	CUBIC METERS	23	23	23	23	23	
	U.S. GALLONS	52,410	52,410	52,410	52,035	52,410	
USABLE FUEL CAPACITY ^⑤	LITERS	198,370	198,370	198,370	196,950	198,370	
	POUNDS	351,150	351,150	351,150	348,635	351,150	
	KILOGRAMS	159,250	159,250	159,250	158,110	159,250	
ENGINE INJECTION WATER CAPACITY	U.S. GALLONS	700	—	700	—	—	
	LITERS	2,650	—	2,650	—	—	

- ① TYPICAL ENGINE/WEIGHT COMBINATIONS SHOWN. SEE SEC. 1.3 FOR OTHER COMBINATIONS AVAILABLE.
- ② IF SIDE CARGO DOOR IS INSTALLED, ADD 5,800 LB (2,630 KG) TO ALL-PASSENGER CONFIGURATION OR 7,830 LB (3,550 KG) TO ALL-CARGO CONFIGURATION.
- ③ IF SIDE CARGO DOOR IS INSTALLED, DEDUCT 5,800 LB (2,630 KG) FROM ALL-PASSENGER CONFIGURATION OR 7,830 LB (3,550 KG) FROM ALL-CARGO CONFIGURATION.
- ④ INCLUDES 29 MAIN-DECK CONTAINERS 96 BY 125 BY 96 IN. (2.44 BY 3.18 BY 2.44 M). ADDITIONAL VOLUME WITH SIDE CARGO DOOR.
- ⑤ EXTENDED RANGE FUEL (1,576 GAL/5,965 L) IS AVAILABLE WITH OEI INCREASE OF 160 LB (73 KG).

2.1.4 GENERAL CHARACTERISTICS
MODEL 747-200C

747-200F						
ALL-CARGO						
CHARACTERISTIC	ENGINE UNITS	JT9D-7AW	JT9D-7FW	RB211- 524D4	CF6- 50E2	JT9D-7Q
MAXIMUM RAMP WEIGHT	POUNDS	778,000	788,000	803,000	823,000	836,000
	KILOGRAMS	352,800	357,400	364,200	373,200	379,100
MAXIMUM LANDING WEIGHT	POUNDS	630,000	630,000	630,000	630,000	630,000
	KILOGRAMS	285,700	285,700	285,700	285,700	285,700
MAXIMUM TAKEOFF OR BRAKE RELEASE WEIGHT	POUNDS	775,000	785,000	800,000	823,000	833,000
	KILOGRAMS	351,500	356,000	362,800	371,900	377,800
OPERATING EMPTY WEIGHT (TYPICAL— VARIES WITH ENGINE/WEIGHT OPTION)	POUNDS	342,180	342,180	351,930	348,120	345,330
	KILOGRAMS	155,180	155,180	159,600	157,880	156,610
ZERO FUEL WEIGHT	POUNDS	590,000	590,000	590,000	590,000	590,000
	KILOGRAMS	267,570	267,570	267,570	267,570	267,570
MAXIMUM STRUCTURAL PAYLOAD	POUNDS	247,820	247,820	238,070	241,880	244,670
	KILOGRAMS	112,390	112,390	107,970	109,690	110,960
MAXIMUM MAIN-DECK CARGO VOLUME-PALLETIZED CARGO	CUBIC FEET	18,270	18,270	18,270	18,270	18,270
	CUBIC METERS	522	522	522	522	522
MAXIMUM LOWER-LOBE CONTAINERIZED CARGO VOLUME	CUBIC FEET	5,250	5,250	5,250	5,250	5,250
	CUBIC METERS	150	150	150	150	150
MAXIMUM LOWER-LOBE BULK CARGO VOLUME	CUBIC FEET	800	800	800	800	800
	CUBIC METERS	23	23	23	23	23
USABLE FUEL CAPACITY	U.S. GALLONS	52,410	52,410	52,410	52,035	52,410
	LITERS	198,370	198,370	198,370	196,950	198,370
	POUNDS	351,150	351,150	351,150	348,635	351,150
	KILOGRAMS	159,250	159,250	159,250	158,110	159,250
ENGINE INJECTION WATER CAPACITY	U.S. GALLONS	700	700	—	—	—
	LITERS	2,650	2,650	—	—	—

④ ADDITIONAL VOLUME WITH SIDE CARGO DOOR.
 ⑤ EXTENDED RANGE FUEL (1,576 GAL/5,965 L) IS
 AVAILABLE WITH OEI INCREASE OF 160 LB (73 KG).

① TYPICAL ENGINE/WEIGHT COMBINATIONS SHOWN.
 SEE SEC. 1.3 FOR OTHER COMBINATIONS AVAILABLE.
 ② FOR SIDE CARGO DOOR, ADD 7,960 LB (3,610 KG).
 ③ FOR SIDE CARGO DOOR, DEDUCT 7,960 LB (3,610 KG).

2.1.5 GENERAL CHARACTERISTICS
MODEL 747-200F

CHARACTERISTIC		ENGINE ①		747-300			747-300SR	
		UNITS	RB211-524B2	CF6-50E2	JT9D-7A	CF6-50E2	JT9D-7A	
MAXIMUM RAMP WEIGHT		POUNDS	713,000	738,000	753,000	523,000	603,000	
		KILOGRAMS	323,400	334,700	341,500	237,200	273,500	
MAXIMUM LANDING WEIGHT		POUNDS	564,000 ②	564,000 ②	564,000 ②	515,000	535,000	
		KILOGRAMS	255,800 ②	255,800 ②	255,800 ②	233,560	242,630	
MAXIMUM TAKEOFF OR BRAKE RELEASE WEIGHT		POUNDS	710,000	735,000	750,000	520,000	600,000	
		KILOGRAMS	322,100	333,300	340,100	235,800	272,100	
OPERATING EMPTY WEIGHT (TYPICAL—VARIES WITH ENGINE/WEIGHT OPTION)		POUNDS	390,300	384,240	381,530	366,700	363,030	
		KILOGRAMS	177,010	174,260	173,030	166,300	164,640	
ZERO FUEL WEIGHT		POUNDS	536,500	526,500	526,500	485,000	495,000	
		KILOGRAMS	243,310	238,780	238,780	219,950	244,490	
MAXIMUM STRUCTURAL PAYLOAD		POUNDS	146,200	142,260	144,970	118,300	131,970	
		KILOGRAMS	66,300	64,520	65,750	53,650	59,850	
MAXIMUM SEATING CAPACITY (INCLUDES 69 SEATS ON OPTIONAL UPPER DECK)	BASIC MIXED ARRANGEMENT (INCLUDES 30 FIRST-CLASS SEATS) ③		565	565	565	—	—	
	ALTERNATE ARRANGEMENT ALL-ECONOMY (10 ABREAST) ③		608	608	608	624 ④	624 ④	
MAXIMUM LOWER-LOBE CONTAINERIZED CARGO VOLUME		CUBIC FEET	5,250	5,250	5,250	5,250	5,250	
		CUBIC METERS	150	150	150	150	150	
MAXIMUM LOWER-LOBE BULK CARGO VOLUME		CUBIC FEET	1,000	1,000	1,000	1,000	1,000	
		CUBIC METERS	28	28	28	28	28	
USABLE FUEL CAPACITY		U.S. GALLONS	48,440	48,070	48,440	48,070	48,440	
		LITERS	183,350	181,950	183,350	181,950	183,350	
		POUNDS	327,000	324,480	327,000	324,480	327,000	
		KILOGRAMS	148,300	147,160	148,300	147,160	148,300	

① TYPICAL ENGINE/WEIGHT COMBINATIONS SHOWN.

② SEE SEC. 1.3 FOR OTHER COMBINATIONS.

③ OPTIONAL LANDING WEIGHT OF 585,000 LB (265,300 KG) IS AVAILABLE.

④ ADDITIONAL 12 ECONOMY CLASS SEATS WITH NO. 3 DOORS DEACTIVATED.

⑤ 85 SEATS ON UPPER DECK.

2.1.6 GENERAL CHARACTERISTICS

MODEL 747-300 (747-100B, NEW AND RETROFIT)

		747-300			
		747-300 OPTION ON 747-200B			
CHARACTERISTIC	ENGINE	CF6-50E2		RB211-524D4	JT9D-7R4G2
	UNITS				
MAXIMUM RAMP WEIGHT	POUNDS	778,000	788,000	803,000	823,000
	KILOGRAMS	352,800	357,400	364,200	373,200
MAXIMUM LANDING WEIGHT ^②	POUNDS	574,000	574,000	574,000	574,000
	KILOGRAMS	260,320	260,320	260,320	260,320
MAXIMUM TAKEOFF OR BRAKE RELEASE WEIGHT	POUNDS	775,000	785,000	800,000	820,000
	KILOGRAMS	351,500	356,000	362,800	371,900
OPERATING EMPTY WEIGHT (TYPICAL—VARIES WITH ENGINE/WEIGHT OPTION)	POUNDS	387,740	387,750	393,180	385,480
	KILOGRAMS	175,850	175,850	178,310	174,790
ZERO FUEL WEIGHT	POUNDS	535,000	535,000	545,000	535,000
	KILOGRAMS	242,630	242,630	247,170	242,630
MAXIMUM STRUCTURAL PAYLOAD	POUNDS	147,260	147,250	151,820	149,520
	KILOGRAMS	66,780	66,780	68,860	67,840
MAXIMUM SEATING CAPACITY (INCLUDES 69 SEATS ON OPTIONAL UPPER DECK)	BASIC MIXED ARRANGEMENT (INCLUDES 30 FIRST-CLASS SEATS) ^③	565	565	565	565
	ALTERNATE ARRANGEMENT ALL-ECONOMY (10 ABBREAST) ^③	608	608	608	608
MAXIMUM LOWER-LOBE CONTAINERIZED CARGO VOLUME	CUBIC FEET	5,250	5,250	5,250	5,250
	CUBIC METERS	150	150	150	150
MAXIMUM LOWER-LOBE BULK CARGO VOLUME	CUBIC FEET	1,000	1,000	1,000	1,000
	CUBIC METERS	28	28	28	28
USABLE FUEL CAPACITY ^④	U.S. GALLONS	52,035	52,035	52,410	52,410
	LITERS	196,950	196,950	198,370	198,370
	POUNDS	348,635	348,635	351,150	351,150
	KILOGRAMS	158,110	158,110	159,250	159,250

① TYPICAL ENGINE/WEIGHT COMBINATIONS SHOWN. SEE SEC. 1.3 FOR OTHER COMBINATIONS AVAILABLE.

② OPTIONAL LANDING WEIGHTS OF 585,000 LB (265,300 KG) AND 630,000 LB (285,700 KG) AVAILABLE.

③ ADDITIONAL 12 ECONOMY CLASS SEATS WITH NO. 3 DOORS DEACTIVATED.

④ EXTENDED RANGE FUEL (1,576 GAL/5,965 L) IS AVAILABLE WITH OEW INCREASE OF 160 LB (73 KG).

2.1.7 GENERAL CHARACTERISTICS
MODEL 747-300 (747-200B, NEW AND RETROFIT)

747-300 COMBI									
747-300 COMBI OPTION ON 747-200B COMBI									
CHARACTERISTIC	ENGINE ①		ALL PASSENGER			6-PALLET		12-PALLET	
	UNITS		CF6-50E2	RB211-524D4	JT9D-7R4G2	CF6-50E2	JT9D-7R4G2	CF6-50E2	JT9D-7R4G2
MAXIMUM RAMP WEIGHT	POUNDS		778,000	788,000	803,000	823,000	836,000		
	KILOGRAMS		352,800	357,400	364,200	373,200	379,100		
MAXIMUM LANDING WEIGHT ②	POUNDS		605,000	605,000	605,000	605,000	605,000		
	KILOGRAMS		274,380	274,380	274,380	274,380	274,380		
MAXIMUM TAKEOFF OR BRAKE RELEASE WEIGHT	POUNDS		775,000	785,000	800,000	820,000	833,000		
	KILOGRAMS		351,500	356,000	362,800	371,900	377,800		
OPERATING EMPTY WEIGHT (TYPICAL—VARIES WITH ENGINE/WEIGHT OPTION)	POUNDS		397,260	402,700	393,810	392,780	385,430	③	
	KILOGRAMS		180,160	182,630	178,600	178,130	174,800	③	
ZERO FUEL WEIGHT	POUNDS		545,000	555,000	545,000	565,000	565,000		
	KILOGRAMS		247,160	251,700	247,160	256,240	256,240		
MAXIMUM STRUCTURAL PAYLOAD	POUNDS		147,740	152,300	151,190	172,220	179,570	③	
	KILOGRAMS		67,000	69,070	68,560	78,110	81,440	③	
MAXIMUM SEATING CAPACITY (INCLUDES 69 SEATS ON OPTIONAL AL UPPER DECK)	BASIC MIXED ARRANGEMENT (INCLUDES 30 FIRST-CLASS SEATS)		565	④	565	④	360	④	278
	ALTERNATE ARRANGEMENT ALL-ECONOMY (10 ABREAST)		608	④	608	④	446	④	336
MAXIMUM LOWER-LOBE & MAIN DECK CONTAINERIZED CARGO VOLUME	CUBIC FEET		5,250	5,250	5,250	9,030	⑤	12,810	⑥
	CUBIC METERS		150	150	150	260	⑤	360	⑥
	CUBIC FEET		1,000	1,000	1,000	1,000	1,000	1,000	
	CUBIC METERS		28	28	28	28	28	28	
USABLE FUEL CAPACITY ⑦	U.S. GALLONS		52,035	52,410	52,410	52,035	52,410		
	LITERS		196,950	198,370	198,370	196,950	198,370		
	POUNDS		348,635	351,150	351,150	348,635	351,150		
	KILOGRAMS		158,110	159,250	159,250	158,110	159,250		

- ① TYPICAL ENGINE/WEIGHT COMBINATIONS SHOWN. SEE SEC. 1.3 FOR OTHER COMBINATIONS AVAILABLE.
- ② OPTIONAL LANDING WEIGHT OF 630,000 LB (285,700 KG) IS AVAILABLE.
- ③ FOR SEVEN- AND THIRTEEN-PALLET CONFIGURATIONS, DEDUCT 510 LB (230 KG) FROM OEW AND ADD TO MAXIMUM STRUCTURAL PAYLOAD.
- ④ ADDITIONAL 12 ECONOMY CLASS SEATS WITH NO. 3 DOORS DEACTIVATED.
- ⑤ INCLUDES SIX 96 BY 125 BY 96 IN. (2.44 BY 3.18 BY 2.44 M) PALLETIZED CARGO MODULES.
- ⑥ INCLUDES TWELVE 96 BY 125 BY 96 IN. PALLETIZED CARGO MODULES.
- ⑦ EXTENDED RANGE FUEL (1,576 GAL/5,965 L) IS AVAILABLE WITH OEW INCREASE OF 160 LB (73 KG).

2.1.8 GENERAL CHARACTERISTICS

MODEL 747-300 COMBI (747-200B COMBI, NEW AND RETROFIT)

		747SP				
		ALL PASSENGER				
CHARACTERISTIC	ENGINE ①	JT9D-7A, -7F, -7J -7AW, -7FW		FB211- 524C2	CF6- 45A2/B2	JT9D-7A
	UNITS					
MAXIMUM RAMP WEIGHT	POUNDS	636,000 ②	666,000 ②	676,000	696,000	703,000
	KILOGRAMS	288,440 ②	302,000 ②	306,660	315,600	318,800
MAXIMUM LANDING WEIGHT ③	POUNDS	450,000	450,000	450,000	450,000	450,000
	KILOGRAMS	204,100	204,100	204,100	204,100	204,100
MAXIMUM TAKEOFF OR BRAKE RELEASE WEIGHT	POUNDS	630,000	660,000	670,000	690,000	696,000
	KILOGRAMS	285,700	299,320	303,900	312,900	315,600
OPERATING EMPTY WEIGHT (TYPICAL— VARIES WITH ENGINE/WEIGHT OPTION)	POUNDS	325,660 ④	325,660 ④	336,870	331,330	326,270
	KILOGRAMS	147,690 ④	147,690 ④	152,780	150,260	147,970
ZERO FUEL WEIGHT ⑤	POUNDS	410,000	410,000	410,000	410,000	410,000
	KILOGRAMS	185,940	185,940	185,940	185,940	185,940
MAXIMUM STRUCTURAL PAYLOAD	POUNDS	84,340 ⑥	84,340 ⑥	73,130	78,670	83,730
	KILOGRAMS	38,250 ⑥	38,250 ⑥	33,160	35,680	37,970
MAXIMUM SEATING CAPACITY (INCLUDES 32 SEATS ON OPTION- AL UPPER DECK)	BASIC MIXED ARRANGEMENT 28 FIRST CLASS, 303 ECONOMY	331	331	331	331	331
	ALTERNATE ARRANGEMENT 28 FC & 9-ABREAST ECONOMY	297	297	297	297	297
MAXIMUM LOWER-LOBE CONTAINERIZED CARGO VOLUME	CUBIC FEET	3,500	3,500	3,500	3,500	3,500
	CUBIC METERS	99	99	99	99	99
MAXIMUM LOWER-LOBE BULK CARGO VOLUME	CUBIC FEET	400	400	400	400	400
	CUBIC METERS	11	11	11	11	11
USABLE FUEL CAPACITY	U.S. GALLONS	48,780 ⑦	48,780 ⑦	50,360	49,980	48,780 ⑦
	LITERS	184,630 ⑦	184,630 ⑦	190,610	189,170	184,630 ⑦
	POUNDS	326,625 ⑦	326,625 ⑦	337,410	334,870	326,625 ⑦
ENGINE INJECTION WATER CAPACITY	KILOGRAMS	148,130 ⑦	148,130 ⑦	153,020	151,870	148,130 ⑦
	U.S. GALLONS	600 ⑧	600 ⑧	—	—	—
	LITERS	2,270 ⑧	2,270 ⑧	—	—	—

- ① TYPICAL ENGINE/WEIGHT COMBINATIONS SHOWN. SEE SEC. 1.3 FOR OTHER COMBINATIONS AVAILABLE.
 ② ADD 5,000 LB (2,270 KG) to JT9D-7AW and JT9D-7FW.
 ③ OPTIONAL LANDING WEIGHT OF 465,000 LB (210,880 KG) IS AVAILABLE.
 ④ ADD 650 LB (295 KG) FOR -7AW and -7FW.
 ⑤ OPTIONAL ZERO FUEL WEIGHT OF 425,000 LB (192,740 KG) IS AVAILABLE.
 ⑥ DEDUCT 650 LB (295 KG) FOR -7AW and -7FW.
 ⑦ EXTENDED RANGE FUEL (1,576 GAL/5,965 L) IS AVAILABLE WITH OEI INCREASE OF 90 LB (40 KG).
 ⑧ JT9D-7AW and JT9D-7FW.

**2.1.9 GENERAL CHARACTERISTICS
MODEL 747SP**

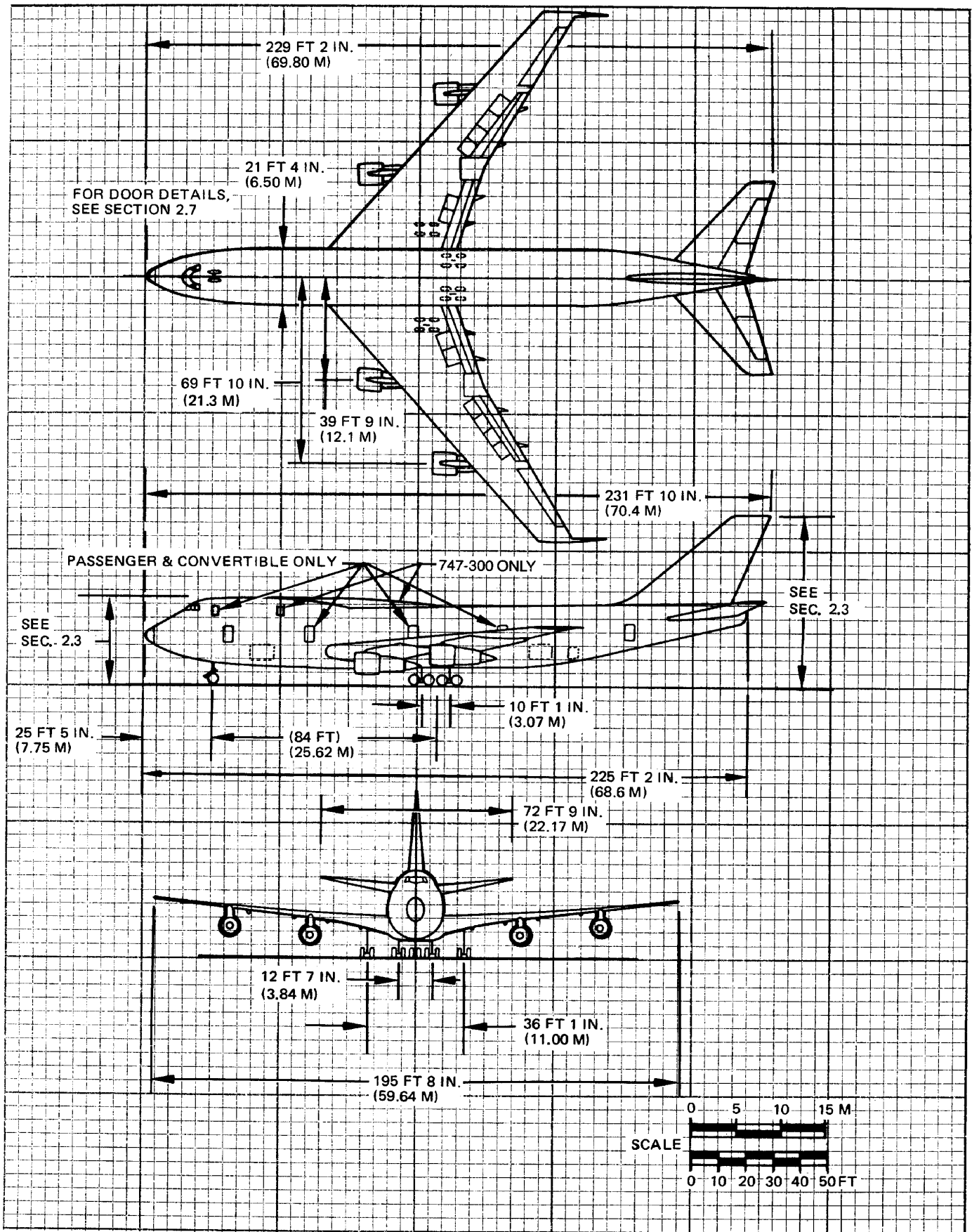

2.2.1 GENERAL DIMENSIONS
MODELS 747-100B, -200, -300

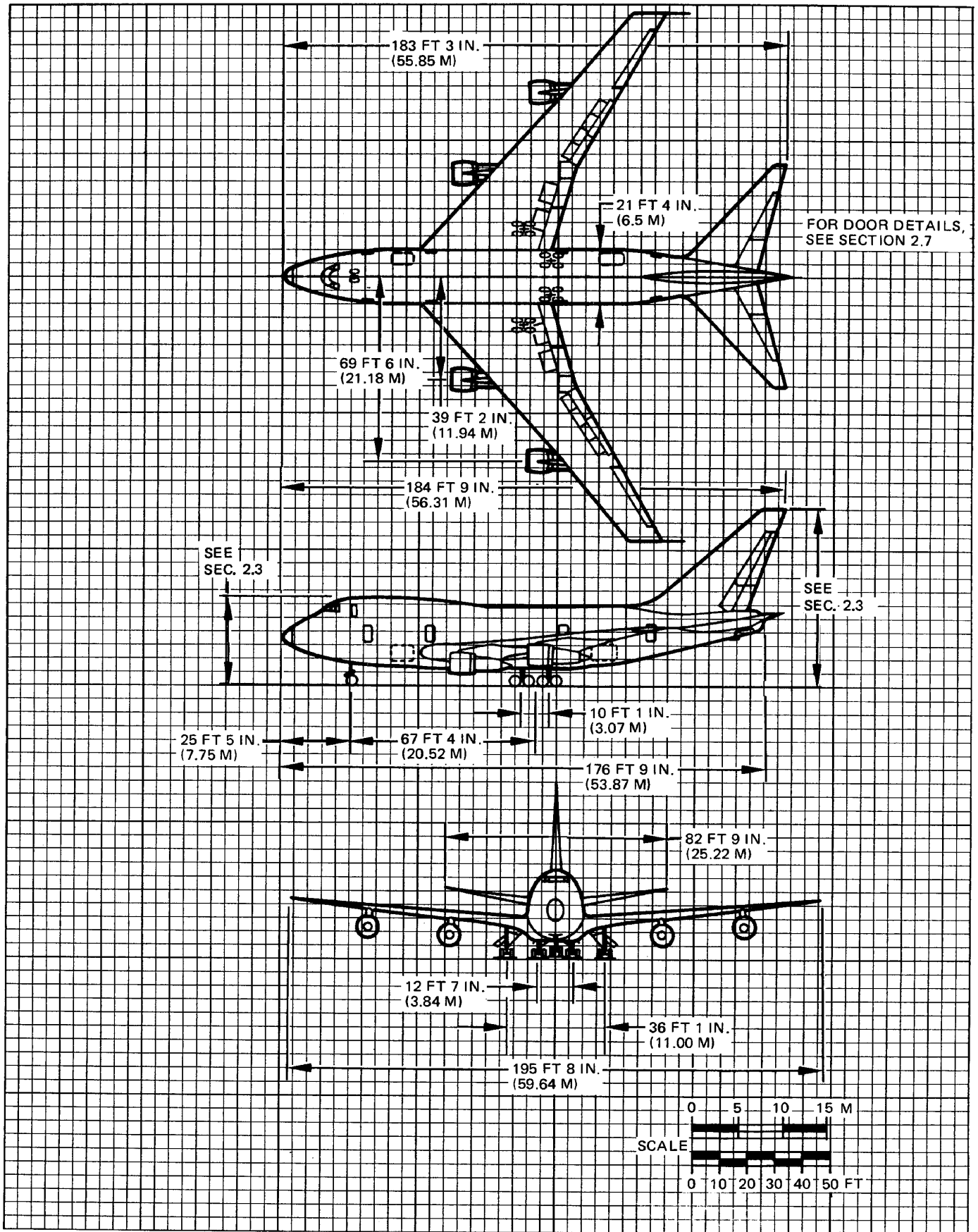

2.2.2 GENERAL DIMENSIONS
MODEL 747SP

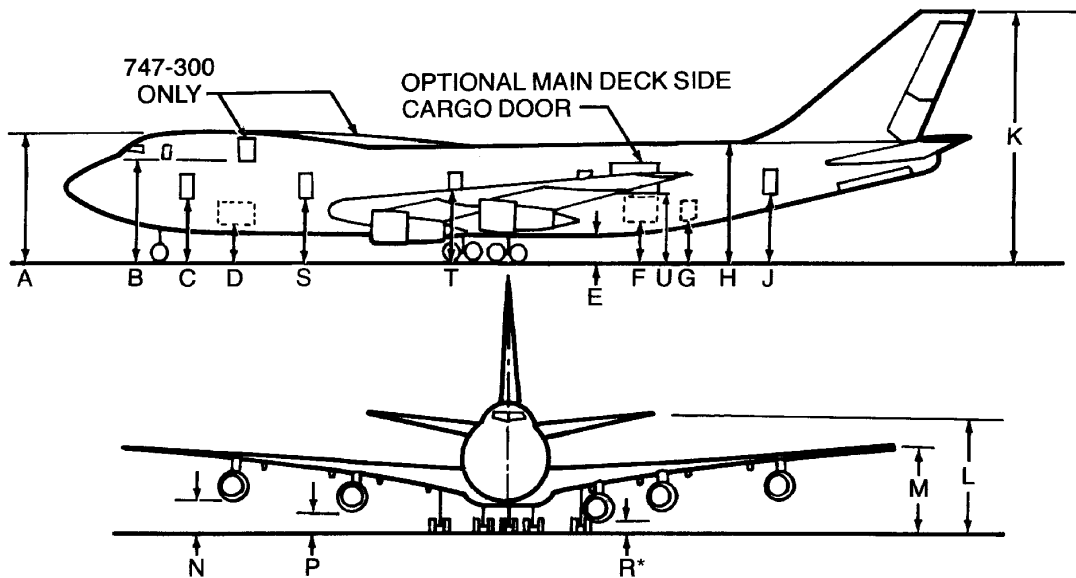

VERTICAL CLEARANCES**				
	MINIMUM		MAXIMUM	
	FT-IN.	M	FT-IN.	M
A	31-10	9.70	34-1	10.39
B	24-10	7.57	27-5	8.36
C	15-3	4.65	17-7	5.36
D	8-8	2.64	10-8	3.25
E	6-3	1.88	6-9	2.08
F	8-10	2.69	10-4	3.15
G	9-6	2.90	11-4	3.46
H	28-6	8.70	31-0	9.43
J	15-0	4.57	17-6	5.33
K	60-2	18.34	64-3	19.58
L	27-0	8.23	30-8	9.35
M	17-7	5.36	19-2	5.84
N	6-0	1.82	7-0	2.13
P	3-9	1.14	4-6	1.37
N	4-11	1.50	6-4	1.93
P	2-7	0.79	3-10	1.17
R*	2-4	0.71	3-0	0.91
S	15-8	4.78	17-2	5.23
T	15-8	4.78	16-7	5.06
U	15-4	4.67	17-6	5.33

} 747-200B WITH
JT9D-70A ENGINES

*DENOTES GROUND CLEARANCE OF BUILT-UP POWER PACKAGE WHEN CARRIED AS SPARE.

**VERTICAL CLEARANCES SHOWN OCCUR DURING MAXIMUM VARIATIONS OF AIRPLANE ATTITUDE. COMBINATIONS OF AIRPLANE LOADING/UNLOADING ACTIVITIES THAT PRODUCE THE GREATEST POSSIBLE VARIATIONS IN ATTITUDE WERE USED TO ESTABLISH THE VARIATIONS SHOWN.

DURING ROUTINE SERVICING, THE AIRPLANE REMAINS RELATIVELY STABLE, PITCH AND ELEVATION CHANGES OCCURRING SLOWLY.

2.3.1 GROUND CLEARANCES—PASSENGER CONFIGURATIONS MODELS 747-100B, -200B, -200C, -300

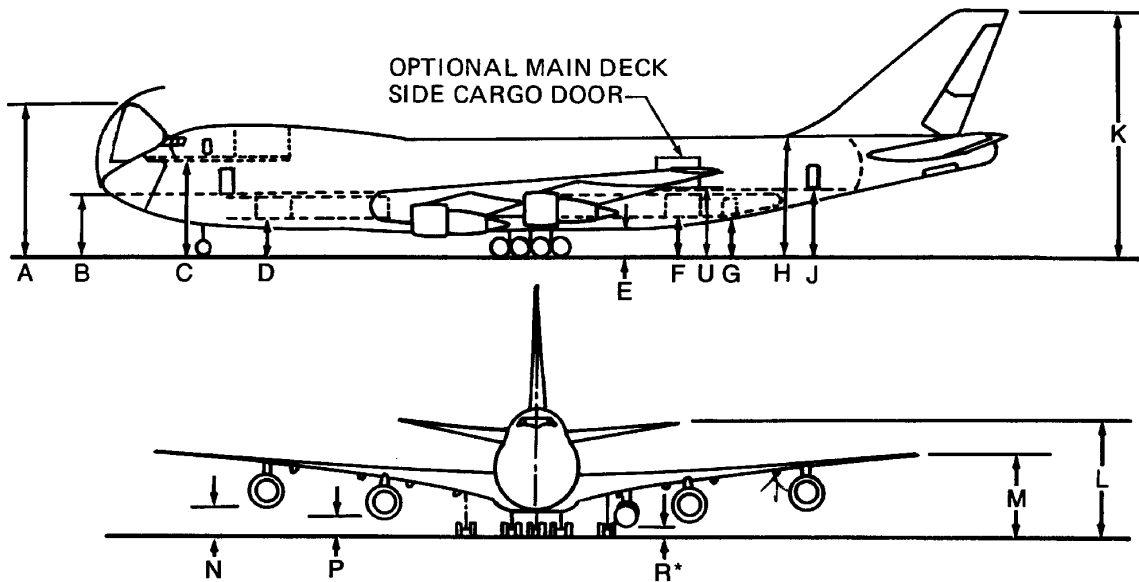

	VERTICAL CLEARANCES**							
	MINIMUM		MAXIMUM		NOSE GEAR TETHERING CONCEPT***			
	FT-IN.	M	FT-IN.	M	MINIMUM		MAXIMUM	
	FT-IN.	M	FT-IN.	M	FT-IN.	M	FT-IN.	M
A	37-8	11.48	40-5	12.32				
B	14-10	4.52	17-11	5.46	16-1	4.95	16-1	4.95
C	24-10	7.57	27-5	8.36				
D	8-6	2.59	10-8	3.25	9-5	2.87	9-7	2.92
E	6-3	1.88	6-9	2.08				
F	8-10	2.69	10-5	3.18	9-3	2.82	10-0	3.05
G	9-6	2.90	11-7	3.53	10-1	3.07	10-10	3.30
H	28-6	8.70	32-6	9.92				
J	15-0	4.57	17-10	5.44				
K	60-1	18.31	64-8	19.71				
L	26-11	8.20	31-2	9.50				
M	17-7	5.36	19-2	5.84				
N	6-0	1.82	7-0	2.13				
P	3-9	1.14	4-6	1.37				
R*	2-4	0.71	3-0	0.91				
U	15-4	4.67	17-6	5.33				

*DENOTES GROUND CLEARANCE OF BUILT-UP POWER PACKAGE WHEN CARRIED AS SPARE.

**VERTICAL CLEARANCES SHOWN OCCUR DURING MAXIMUM VARIATIONS OF AIRPLANE ATTITUDE. COMBINATIONS OF AIRPLANE LOADING/UNLOADING ACTIVITIES THAT PRODUCE THE GREATEST POSSIBLE VARIATIONS IN ATTITUDE WERE USED TO ESTABLISH THE VARIATIONS SHOWN. DURING ROUTINE SERVICING, THE AIRPLANE REMAINS RELATIVELY STABLE, PITCH AND ELEVATION CHANGES OCCURRING SLOWLY.

***AT MAJOR TERMINALS, A GSE TETHERING DEVICE MAY BE USED TO MAINTAIN STABILITY BETWEEN THE MAIN DECK DOOR SILL AND THE LOADING DOCK, OR CARGO BRIDGE ATTACHMENT FITTINGS LOCATED ON THE NOSE DOOR SILL AT THE FORWARD EDGE OF THE MAIN CARGO DECK MAY BE USED FOR CARGO SILL STABILIZATION.

2.3.2 GROUND CLEARANCES — CARGO CONFIGURATIONS MODELS 747-200C, -200F

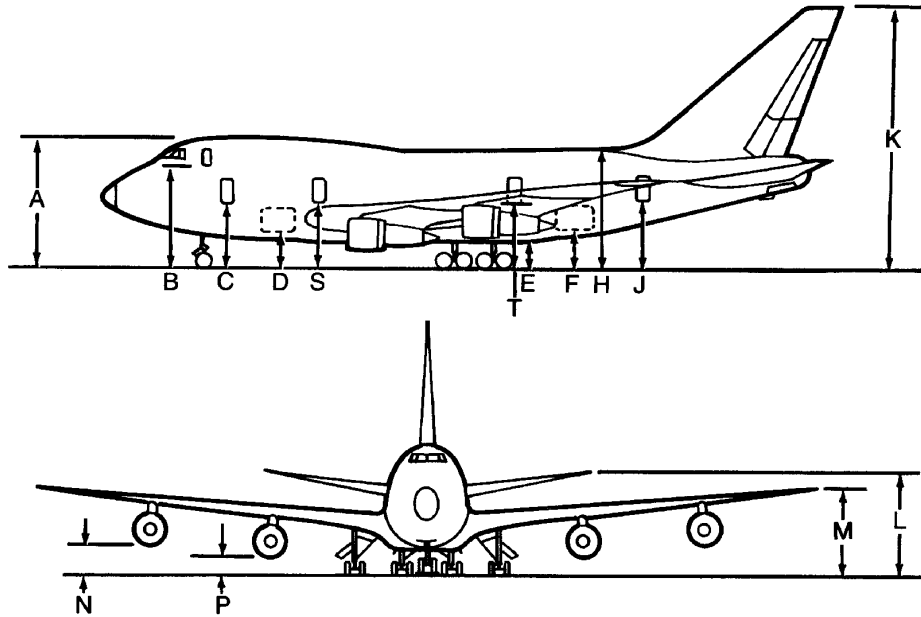

	VERTICAL CLEARANCES			
	MINIMUM*		MAXIMUM**	
	FT-IN.	M	FT-IN.	M
A	32-3	9.83	33-0	10.05
B	25-4	7.73	26-1	7.95
C	15-8	4.77	16-4	4.98
D	9-0	2.74	9-8	2.96
E	7-5	2.26	8-1	2.46
F	9-6	2.89	10-2	3.10
H	29-10	9.09	30-6	9.30
J	16-4	4.98	17-0	5.19
K	65-1	19.84	65-10	20.06
L	26-6	8.07	27-3	8.31
M	17-2	5.23	19-4	5.89
N	5-7	1.71	7-0	2.14
P	3-7	1.10	4-5	1.35
S	15-10	4.82	16-6	5.03
T	16-2	4.92	16-10	5.14

*MAXIMUM GROSS WEIGHT 666,000 LB (302,000 KG); (11% WT. ON NOSE GEAR)

**OPERATING EMPTY WEIGHT 315,000 LB (143,000KG); (8% WT. ON NOSE GEAR)

2.3.3 GROUND CLEARANCES—PASSENGER CONFIGURATION MODEL 747SP

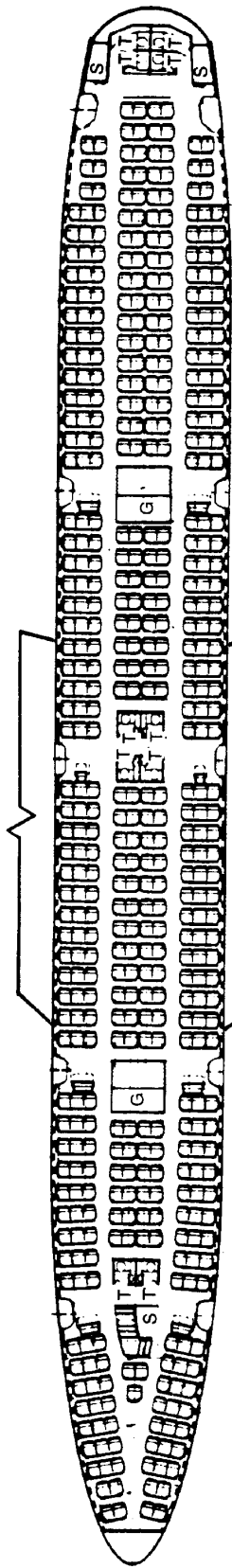

- 513 SEATS AT 31- TO 34- IN. (0.79- TO 0.86-M) PITCH
 - STRAIGHT STAIRS TO UPPER DECK
- HIGH DENSITY SEATING (747-100B SR)**

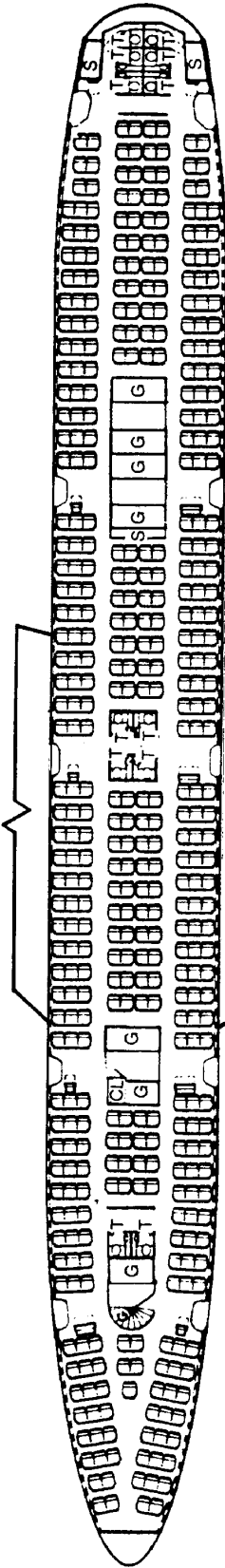

- 448 SEATS AT 34-IN. (0.86-M) PITCH
 - CIRCULAR STAIRS TO UPPER DECK
- INTERNATIONAL ALL-ECONOMY ARRANGEMENT**

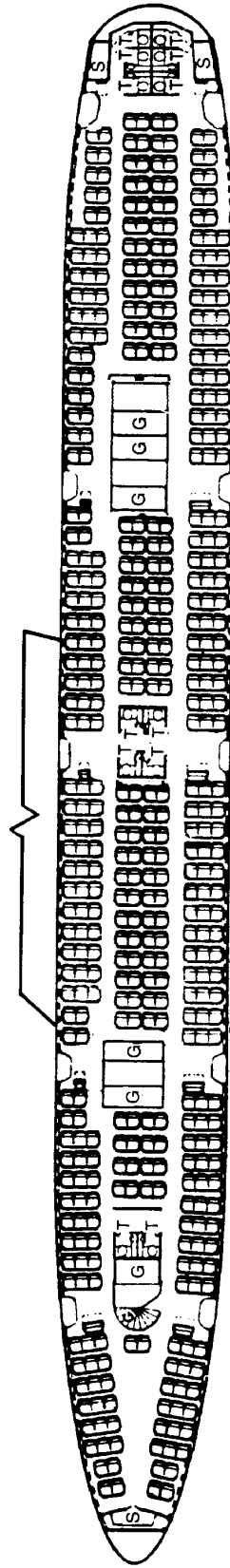

- 478 SEATS AT 31-IN. (0.79-M) PITCH
 - CIRCULAR STAIRS TO UPPER DECK
- STANDARD ALL-ECONOMY ARRANGEMENT**



**2.4.1. INTERIOR ARRANGEMENTS—MAIN DECK, ALL ECONOMY SEATS
MODELS 747-100B, -200 (PASSENGER CONFIGURATIONS)**

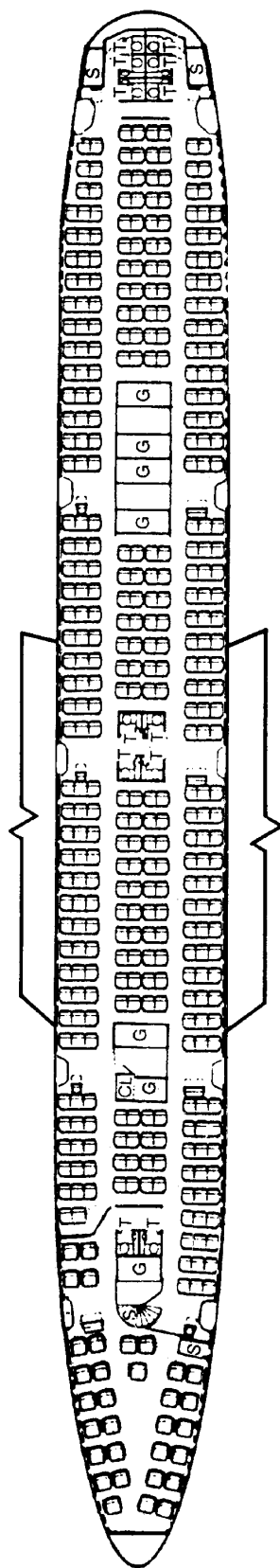

● 420 SEATS

- 32 FIRST CLASS AT 41-IN. (1.04-M) PITCH
- 388 ECONOMY CLASS AT 34-IN. (0.86-M) PITCH

BASIC MIXED-CLASS CONFIGURATION

NO. 3 DOOR LOCATION
(LH & RH)

CONTAINERS ARE LOADED
THROUGH NO. 5 LH DOOR

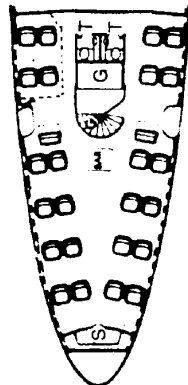

● 24 FIRST CLASS SLEEPER SEATS AT 56- TO 62-IN. (1.42- TO 1.57-M) PITCH

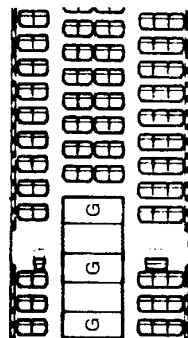

● 9-ABREAST SEATS

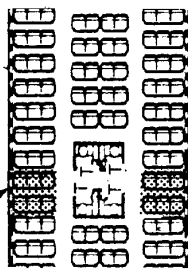

● 12 ADDITIONAL SEATS WITH NO. 3 DOOR DEACTIVATED

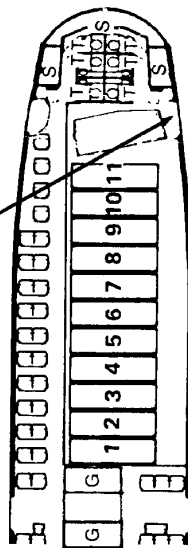

● MAIN DECK BAGGAGE CONTAINERS
EACH CONTAINER 38 IN. (0.97M) WIDE,
125 IN. (3.17M) LONG, 64 IN. (1.63M) HIGH
MAX GROSS WEIGHT 1,750 LB (790 KG)

OPTIONAL CONFIGURATIONS

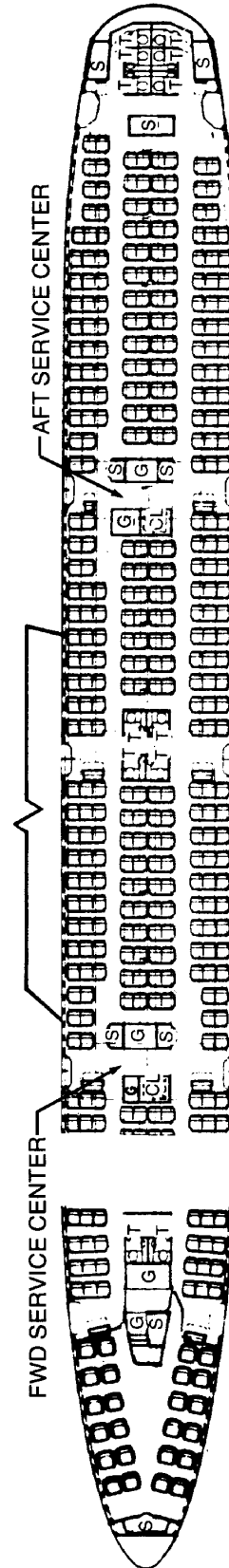

● STRAIGHT STAIRS TO UPPER DECK

● LOWER LOBE GALLEYS

[G] GALLEY

[T] TOILET

[S] STORAGE

[CL] CART LIFT

2.4.2. INTERIOR ARRANGEMENTS—MAIN DECK, MIXED CLASS CONFIGURATION
MODELS 747-100B, -200B, -200C

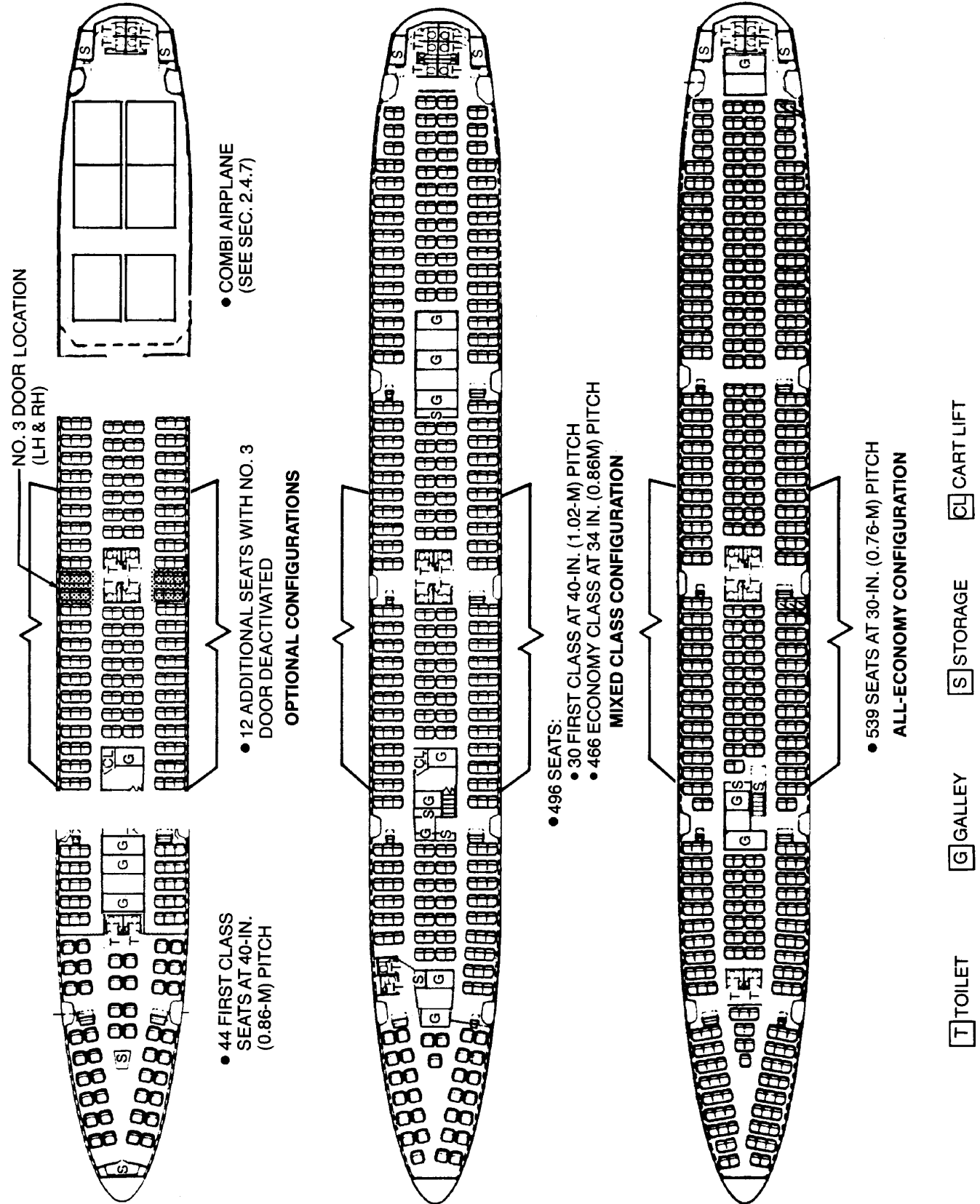

2.4.3 INTERIOR ARRANGEMENTS—MAIN DECK
MODEL 747-300

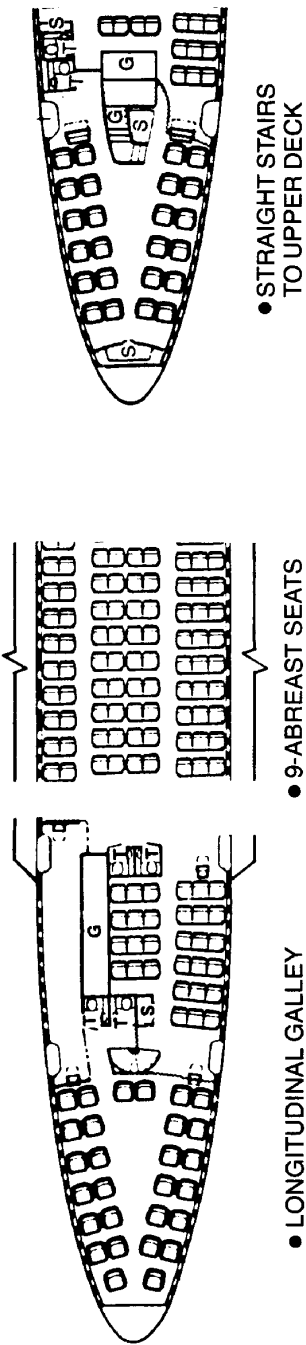

OPTIONAL CONFIGURATIONS

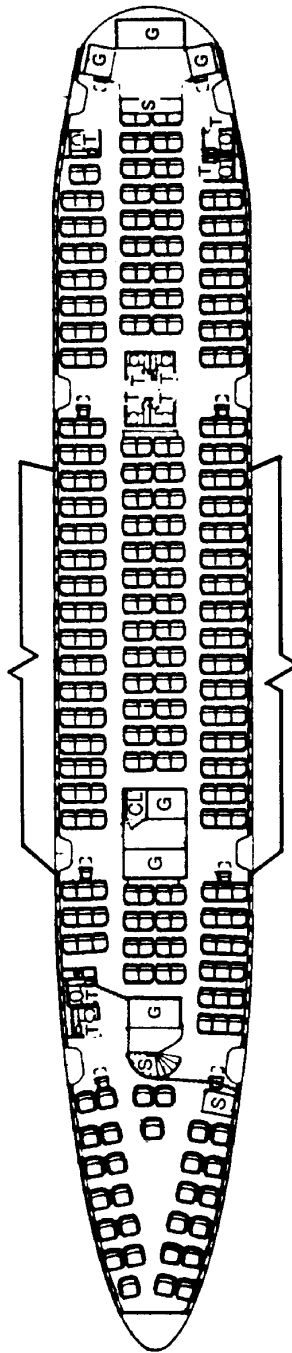

STANDARD ARRANGEMENT

- T TOILET
- G GALLEY
- S STORAGE
- CL CART LIFT

2.4.4 INTERIOR ARRANGEMENTS—MAIN DECK, MIXED CLASS CONFIGURATIONS
MODEL 747SP

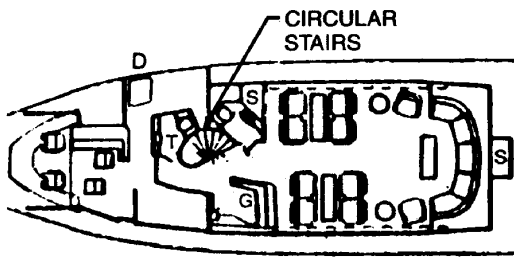

15-PLACE LOUNGE

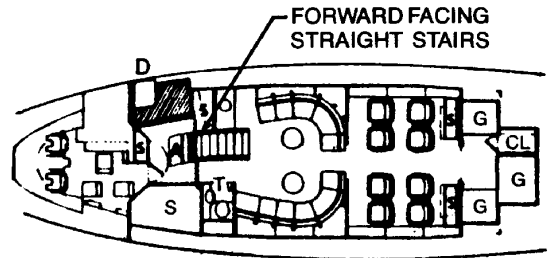

8 FIRST CLASS SEATS
PLUS 11-PLACE LOUNGE

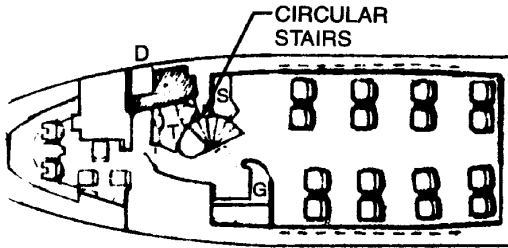

16 FIRST CLASS
SLEEPER SEATS

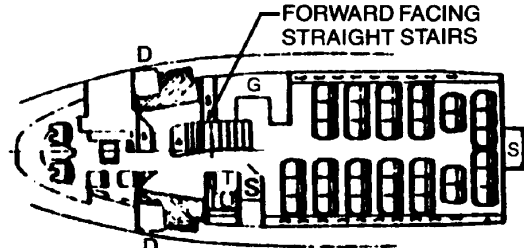

37 ECONOMY CLASS SEATS

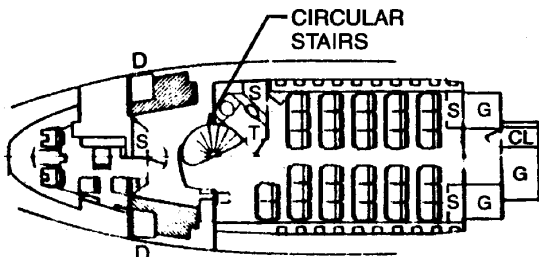

32 ECONOMY CLASS SEATS

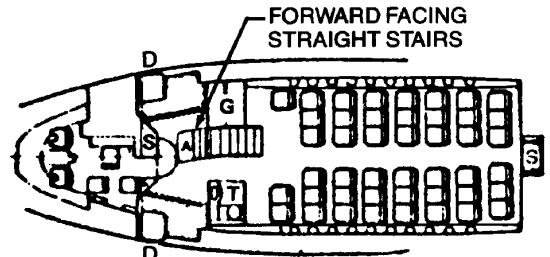

45 ECONOMY CLASS SEATS

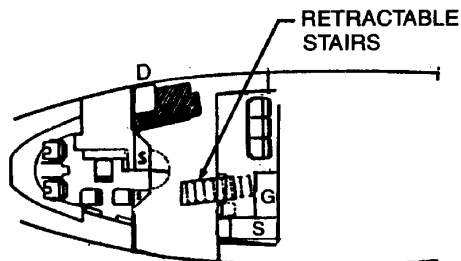

3-PLACE CREW LOUNGE
(747-100SF, 747-200F)

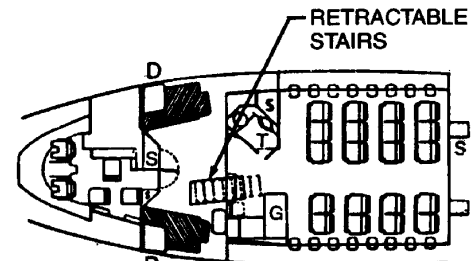

20 ECONOMY CLASS SEATS
(747-200F)

T TOILET

G GALLEY

S STORAGE

CL CART LIFT

D EXIT DOOR

2.4.5 INTERIOR ARRANGEMENTS — UPPER DECK SEATING OPTIONS MODELS 747-100, -200, SP

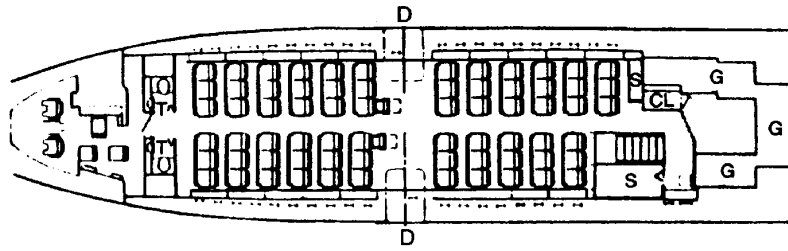

69 ECONOMY CLASS SEATS
AT 34-IN. (0.86-M) PITCH

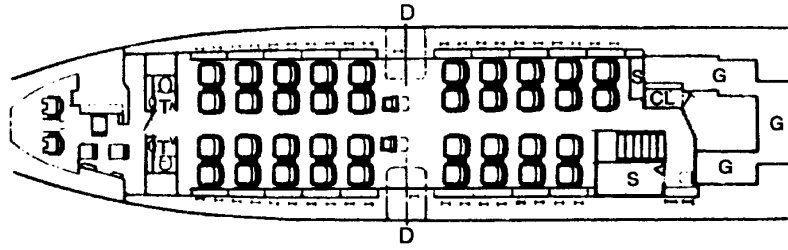

38 FIRST CLASS SEATS
AT 40-IN./42-IN. (1.02-M/1.07-M) PITCH

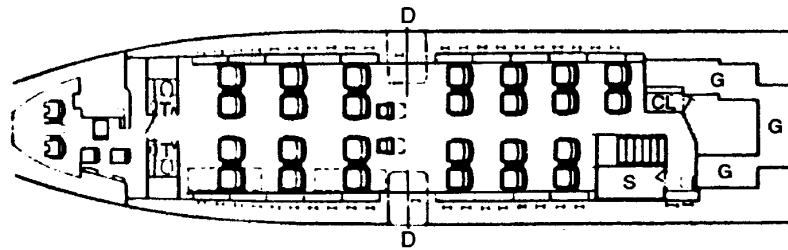

26 FIRST CLASS SLEEPERS
AT 62-IN. (1.57-M) PITCH

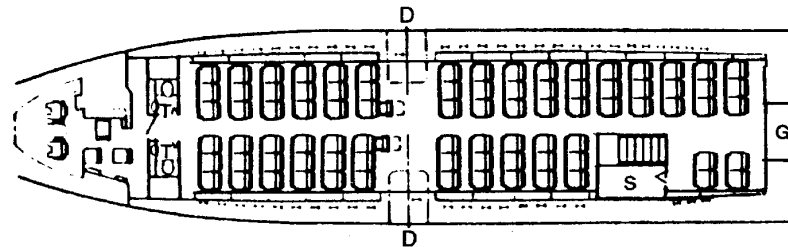

85 ECONOMY CLASS SEATS
AT 33-IN. (0.84-M) PITCH

T TOILET **G** GALLEY **S** STORAGE **CL** CART LIFT **D** EXIT DOOR

2.4.6 INTERIOR ARRANGEMENT—UPPER DECK SEATING OPTIONS
MODEL 747-300

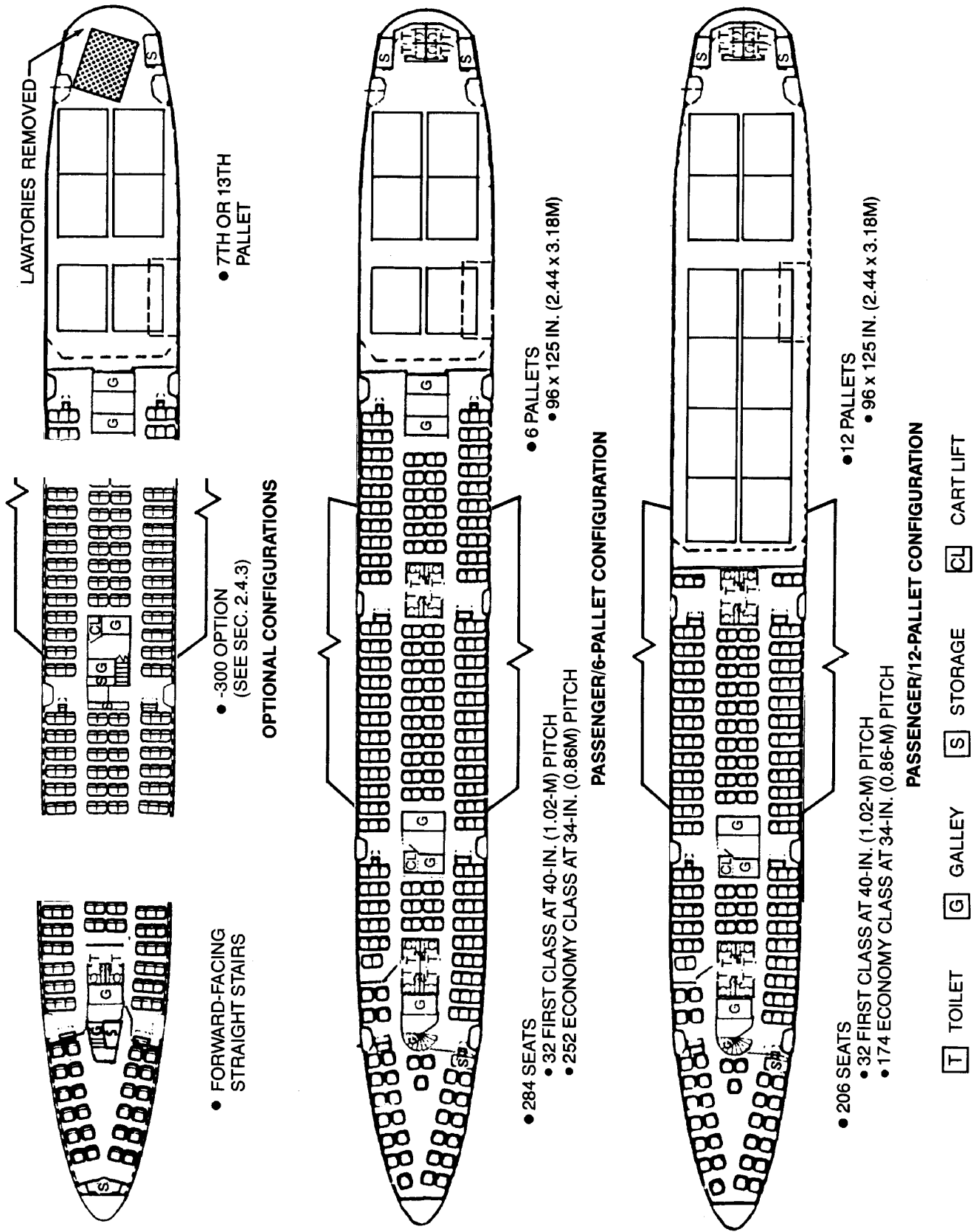

2.4.7 INTERIOR ARRANGEMENTS — MAIN DECK, PASSENGER/CARGO COMBINATIONS
MODELS 747-200B COMBI, -300 COMBI

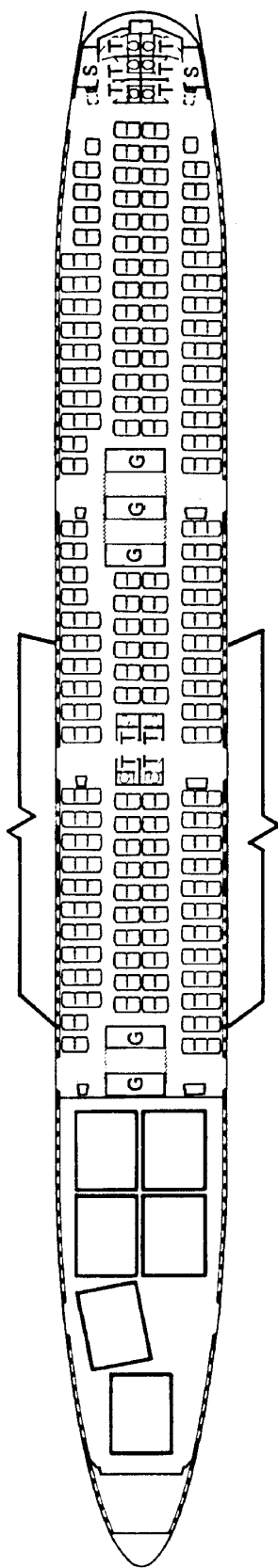

- 6 PALLETS, EACH 96 x 125 IN. (2.44 x 3.18M)
UP TO 96 IN. (2.44M) HIGH
- 322 ECONOMY CLASS SEATS AT 34-IN. (0.86-M) PITCH

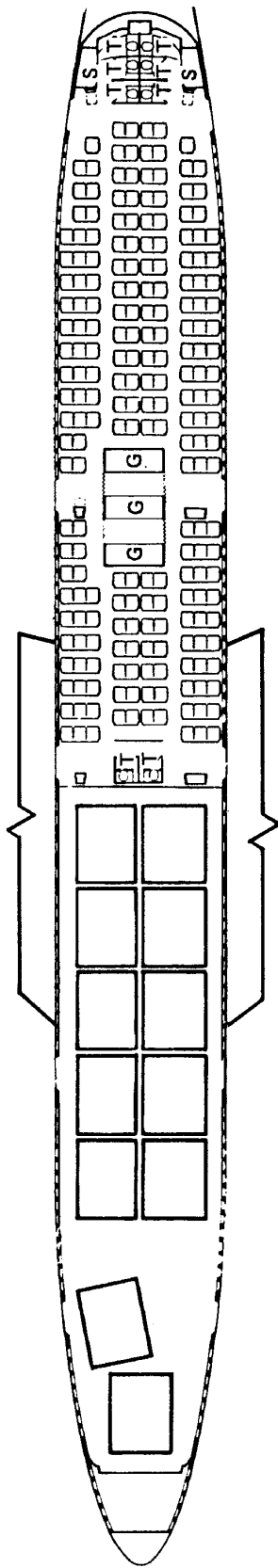

- 12 PALLETS, EACH 96 x 125 IN. (2.44 x 3.18M)
UP TO 96 IN. (2.44M) HIGH
- 219 ECONOMY CLASS SEATS AT 34-IN. (0.86-M) PITCH

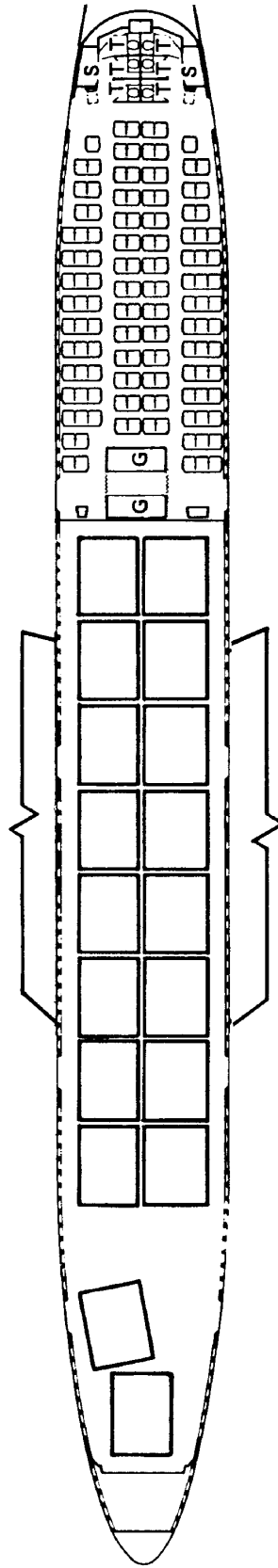

- 18 PALLETS, EACH 96 x 125 IN. (2.44 x 3.18M)
UP TO 96 IN. (2.44M) HIGH
- 134 ECONOMY CLASS SEATS AT 34-IN. (0.86-M) PITCH

[T] TOILET [G] GALLEY [S] STORAGE

2.4.8 INTERIOR ARRANGEMENTS—MAIN DECK, PASSENGER/CARGO COMBINATIONS MODEL 747-200C

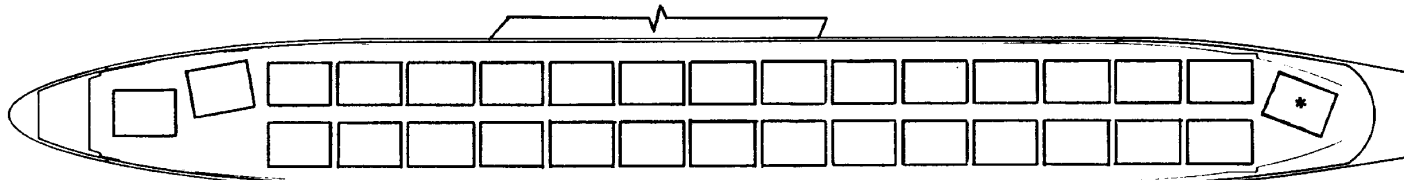

● 31 10-FOOT CONTAINERS

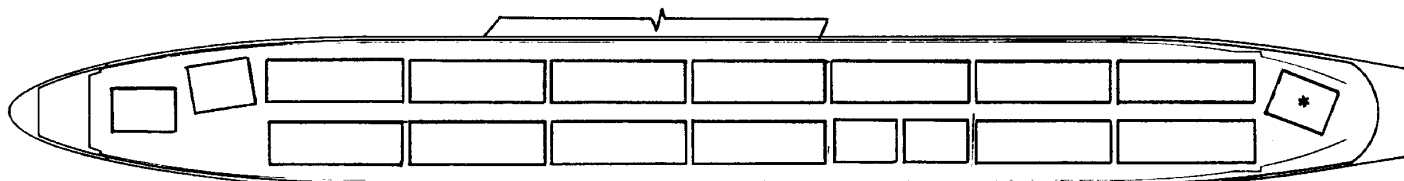

① ● 13 20-FOOT CONTAINERS
● 5 10-FOOT CONTAINERS

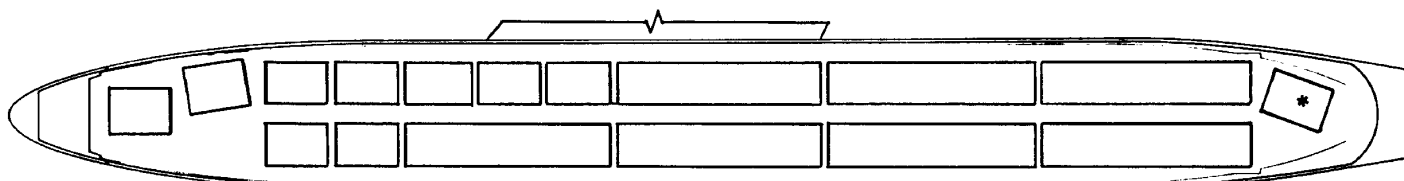

② ● 7 30-FOOT CONTAINERS
● 10 10-FOOT CONTAINERS

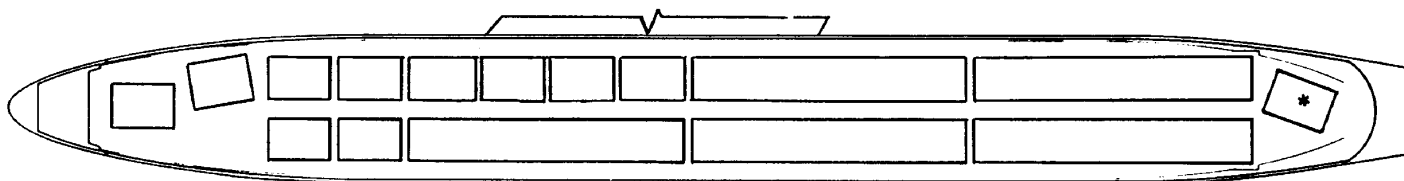

② ● 5 40-FOOT CONTAINERS
● 11 10-FOOT CONTAINERS

- ① SPECIAL PROCEDURES ARE REQUIRED FOR SIDE-LOADING 20-FOOT CONTAINERS.
② 30-FOOT AND 40-FOOT CONTAINERS ARE LOADED THROUGH THE NOSE DOOR ONLY AND CANNOT BE LOADED INTO THE 747-100SF. THE SF DOES NOT HAVE NOSE-LOADING CAPABILITY.

CONTAINER DATA

DIMENSIONS							VOLUME		MAX. GROSS WEIGHT**	
LENGTH	INCHES			METERS						
FEET	W	L	H	W	L	H	CU FT	CU M	LB	KG
10	96	117.75	96	2.44	2.99	2.44	550	15.58	12,500	5,675
20	96	238.50	96	2.44	6.06	2.44	1,160	32.85	25,000	11,350
30	96	359.25	96	2.44	9.12	2.44	1,775	50.27	35,000	15,890
40	96	480.00	96	2.44	12.19	2.44	2,350	66.55	45,000	20,430

*OPTIONAL CAPABILITY

**MAXIMUM GROSS WEIGHTS ARE BASED ON MAXIMUM MAIN-DECK RUNNING LOAD CAPABILITY OR CURRENT CARGO MODULE SPECIFICATION LIMIT

2.4.9 INTERIOR ARRANGEMENTS—MAIN DECK, CONTAINERIZED CARGO
MODELS 747-100SF, -200C, -200F

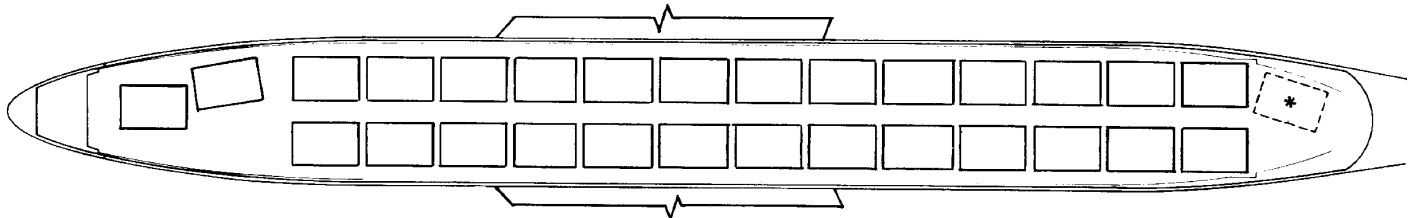

28 PALLETS

96 BY 125 BY 96 IN. (2.44 BY 3.18 BY 2.44 M)

630 CU FT (18.0 CU M) EACH
 MGW** 15,000 LB (6,810 KG) EACH
 TOTAL 17,640 CU FT (498 CU M)

28 PALLETS

88 BY 125 BY 96 IN. (2.23 BY 3.18 BY 2.44 M)

580 CU FT (16.4 CU M) EACH
 MGW** 15,000 LB (6,810 KG) EACH
 TOTAL 16,240 CU FT (460 CU M)

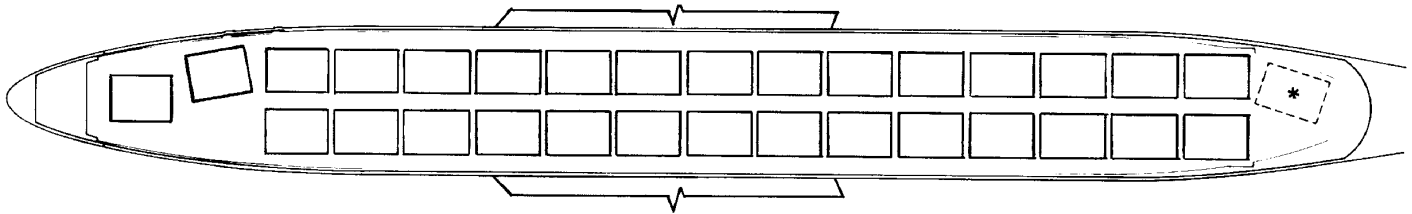

30 PALLETS

96 BY 117.75 BY 96 IN. (2.44 BY 2.99 BY 2.44 M)

585 CU FT (16.6 CU M) EACH
 MGW** 12,500 LB (5,675 KG) EACH
 TOTAL 17,550 CU FT (497 CU M)

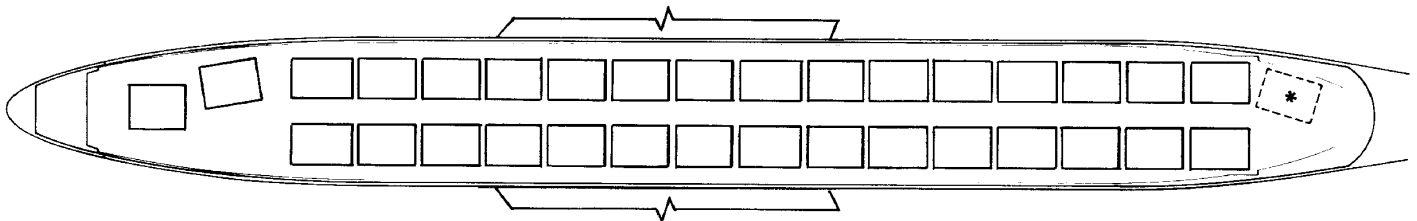

32 PALLETS

88 BY 108 BY 96 IN. (2.23 BY 2.74 BY 2.44 M)

(COMMERCIAL)

498 CU FT (14.1 CU M) EACH
 MGW** 13,000 LB (5,902 KG)
 TOTAL 15,936 CU FT (450 CU M)

(MILITARY)

490 CU FT (13.9 CU M) EACH
 MGW** 13,000 LB (5,902 KG)
 TOTAL 15,680 CU FT (443 CU M)

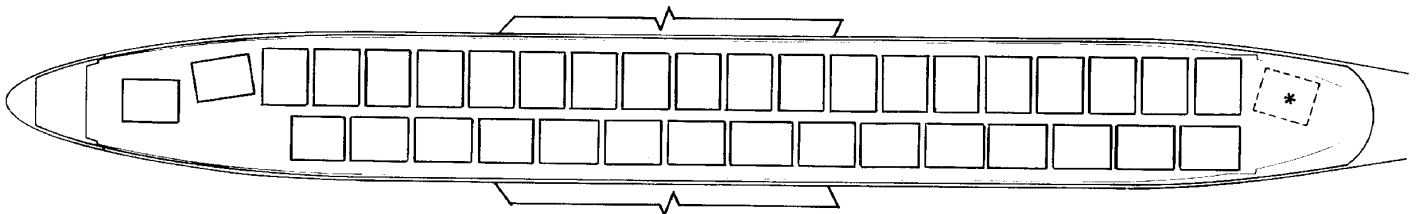

36 PALLETS

88 BY 108 BY 96 IN. (2.23 BY 2.74 BY 2.44 M)

(MILITARY)

490 CU FT (13.9 CU M) EACH
 MGW** 13,000 LB (5,902 KG)
 TOTAL 17,640 CU FT (498 CU M)

* OPTIONAL CAPABILITY. STANDARD ON 747-200F.

** MAXIMUM GROSS WEIGHTS (MGW) ARE BASED ON MAXIMUM MAIN-DECK RUNNING LOAD CAPABILITY OR CURRENT CARGO MODULE SPECIFICATION UNIT.

2.4.10 INTERIOR ARRANGEMENTS—MAIN DECK, PALLETIZED CARGO
 MODELS 747-100SF, -200C, -200F

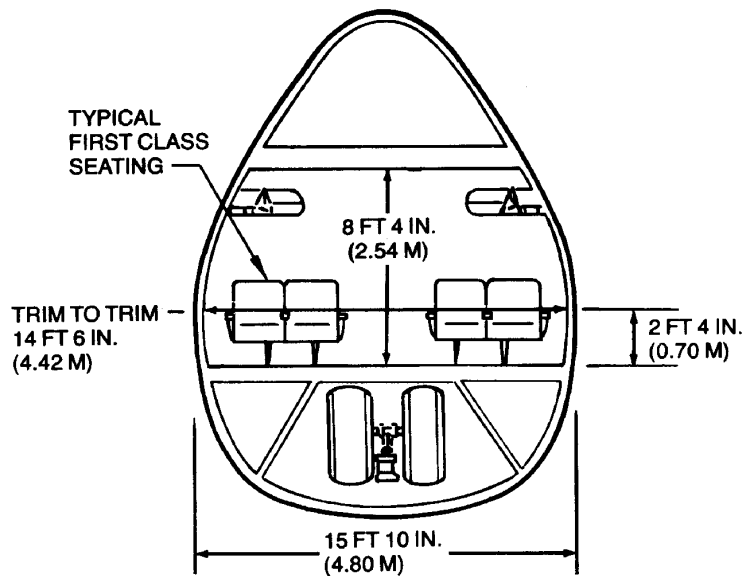

VIEW LOOKING AFT

FORWARD CABIN
18 FT (5.60 M) AFT OF NOSE

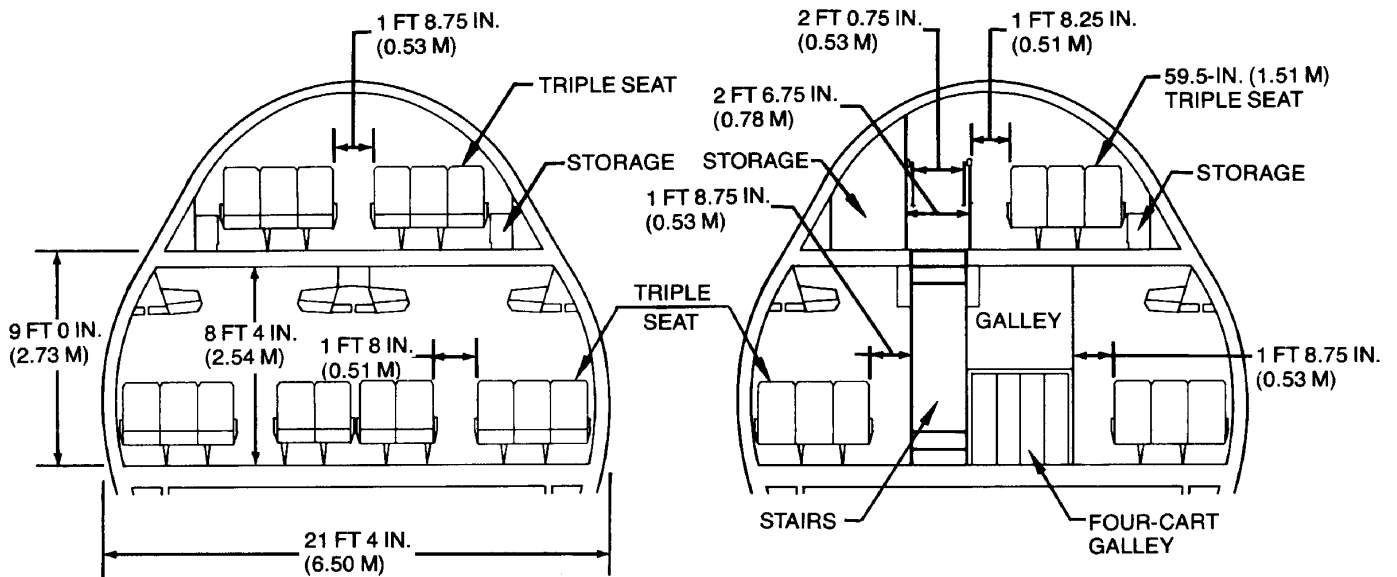

VIEW LOOKING AFT

CONSTANT UPPER DECK SECTION

VIEW LOOKING FORWARD

AFT-FACING STAIRS TO UPPER DECK (747-300)

SEE SEC. 2.6 FOR
LOWER CARGO COMPARTMENT
DETAILS

2.5.1 CABIN CROSS SECTIONS — FORWARD CABIN
MODEL 747

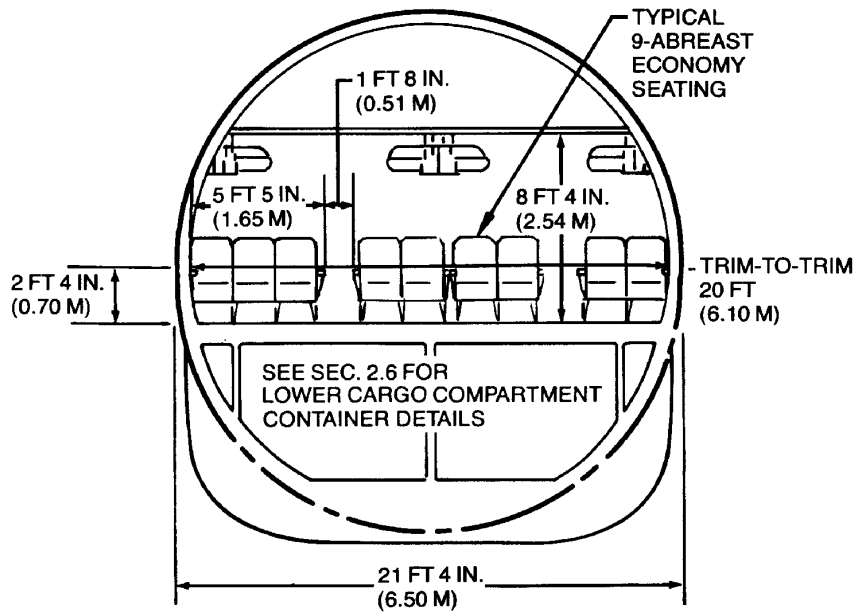

PASSENGER CONFIGURATION

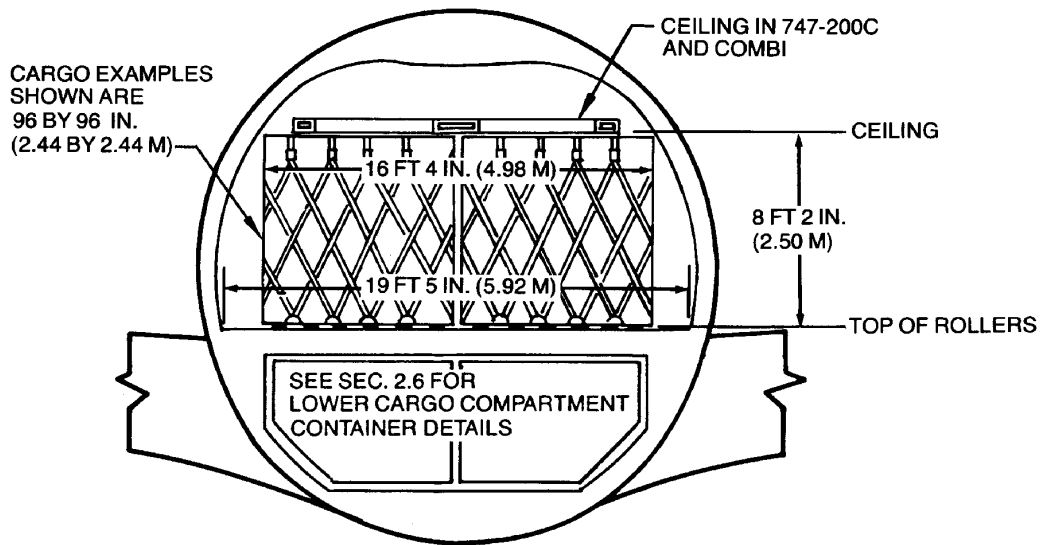

CONVERTIBLE AND FREIGHTER CONFIGURATION

**2.5.2 CABIN CROSS SECTIONS — CONSTANT BODY SECTION
MODEL 747**

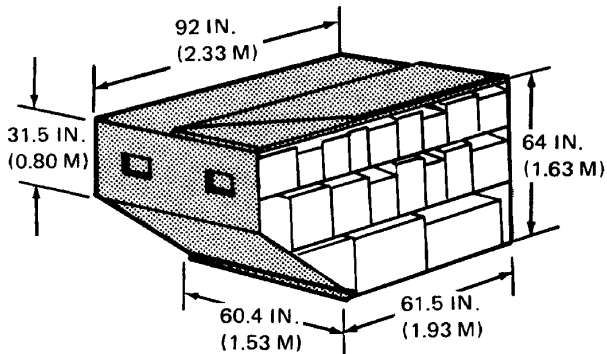
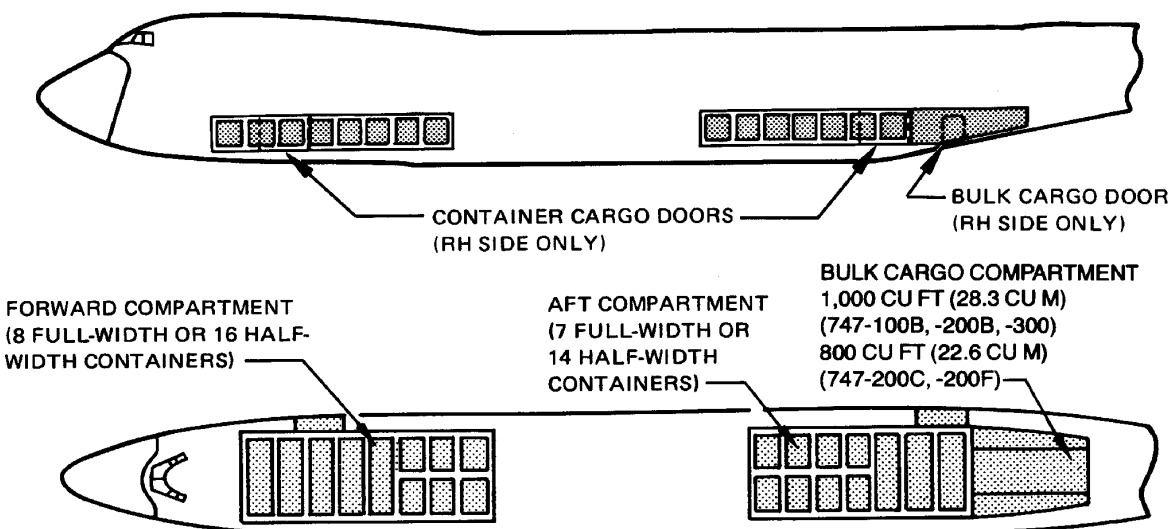

HALF-WIDTH CONTAINER

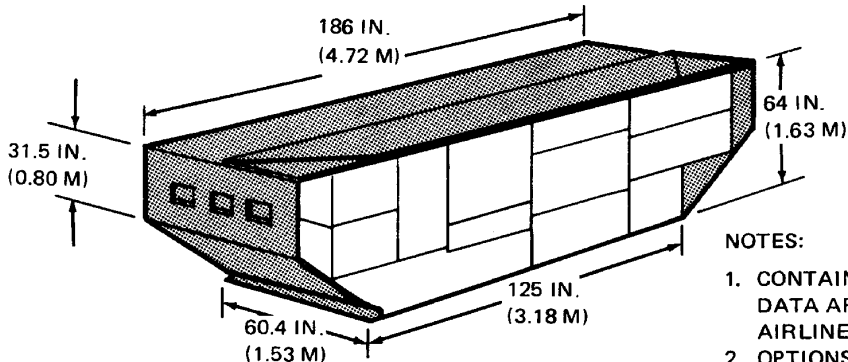

FULL-WIDTH CONTAINER

CONTAINER DATA		
	HALF-WIDTH	FULL-WIDTH
INTERNAL VOLUME PER CONTAINER	173 CU FT 4.9 CU M	350 CU FT 9.9 CU M
TARE WEIGHT PER CONTAINER	270 LB 123 KG	470 LB 213 KG
MAXIMUM CARGO WEIGHT PER CONTAINER	3,230 LB 1,467 KG	6,530 LB 2,965 KG
MAXIMUM GROSS WEIGHT PER CONTAINER	3,500 LB 1,590 KG	7,000 LB 3,180 KG
TOTAL VOLUME OF 15 FULL-WIDTH CONTAINERS -5,250 CU FT (148.5 CU M)		
TOTAL VOLUME OF 30 HALF-WIDTH CONTAINERS -5,190 CU FT (147.0 CU M)		
GROSS WEIGHT FOR 15 FULL-WIDTH OR 30 HALF-WIDTH CONTAINERS-105,000 LB (47,670 KG)		

NOTES:

1. CONTAINER WEIGHT AND VOLUME DATA ARE TYPICAL. CONSULT USING AIRLINE FOR SPECIFIC DATA.
2. OPTIONS ARE OFFERED FOR CARRIAGE OF CERTAIN STANDARD MILITARY AND COMMERCIAL PALLETS IN CONTAINER COMPARTMENTS.

2.6.1 LOWER CARGO COMPARTMENTS — CONTAINERS AND BULK CARGO
MODELS 747-100B, -200, -300

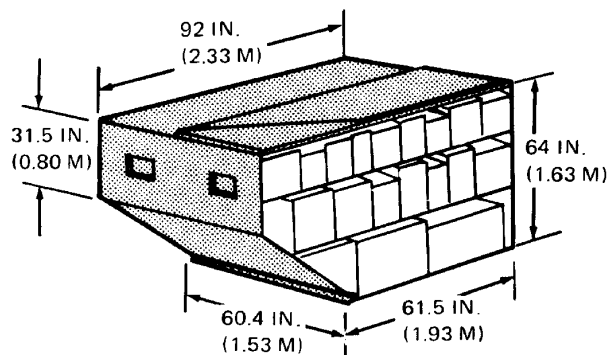
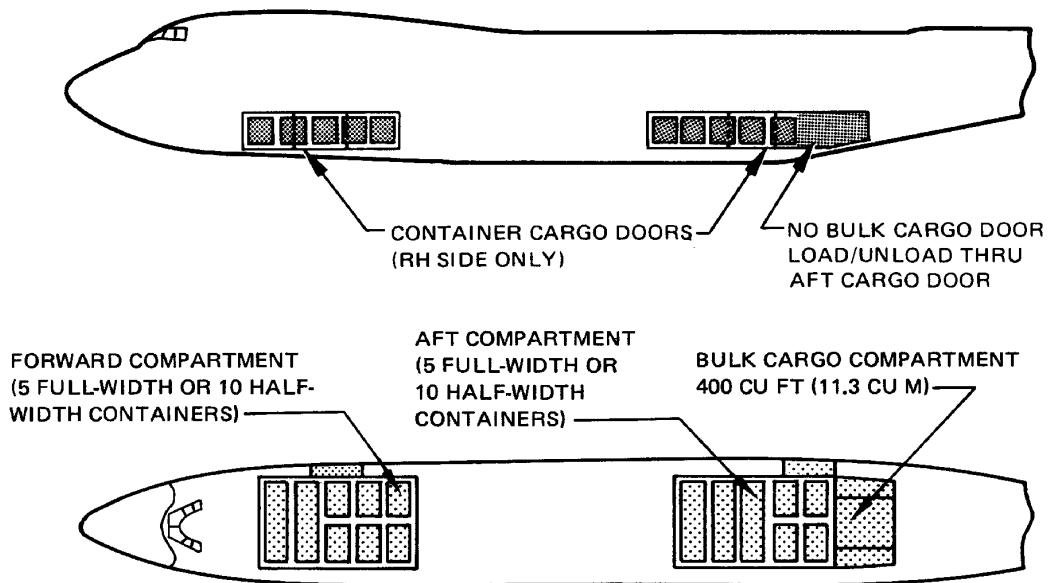

HALF-WIDTH CONTAINER

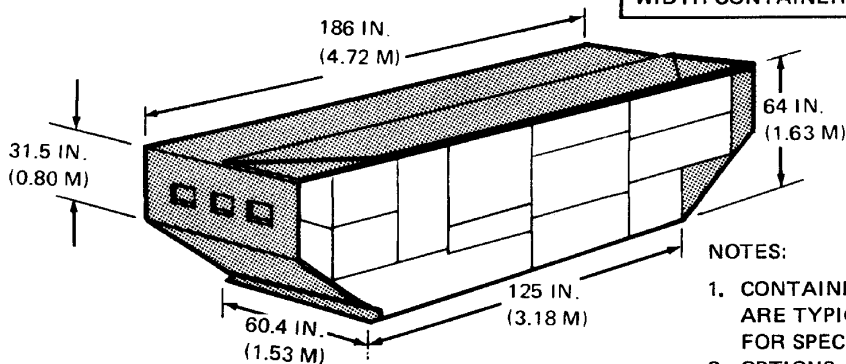

FULL-WIDTH CONTAINER

CONTAINER DATA		
	HALF-WIDTH	FULL-WIDTH
INTERNAL VOLUME PER CONTAINER	173 CU FT 4.9 CU M	350 CU FT 9.9 CU M
TARE WEIGHT PER CONTAINER	270 LB 123 KG	470 LB 213 KG
MAXIMUM CARGO WEIGHT PER CONTAINER	3,230 LB 1,467 KG	6,530 LB 2,965 KG
MAXIMUM GROSS WEIGHT PER CONTAINER	3,500 LB 1,590 KG	7,000 LB 3,180 KG
TOTAL VOLUME OF 10 FULL-WIDTH CONTAINERS -3,500 CU FT (99.0 CU M)		
TOTAL VOLUME OF 20 HALF-WIDTH CONTAINERS -3,460 CU FT (97.9 CU M)		
GROSS WEIGHT FOR 10 FULL-WIDTH OR 20 HALF-WIDTH CONTAINERS-70,000 LB (31,780 KG)		

NOTES:

1. CONTAINER WEIGHT AND VOLUME DATA ARE TYPICAL. CONSULT USING AIRLINE FOR SPECIFIC DATA
2. OPTIONS ARE OFFERED FOR CARRIAGE OF CERTAIN STANDARD MILITARY AND COMMERCIAL PALLETS IN CONTAINER COMPARTMENTS.

2.6.2 LOWER CARGO COMPARTMENTS — CONTAINERS AND BULK CARGO
MODEL 747SP

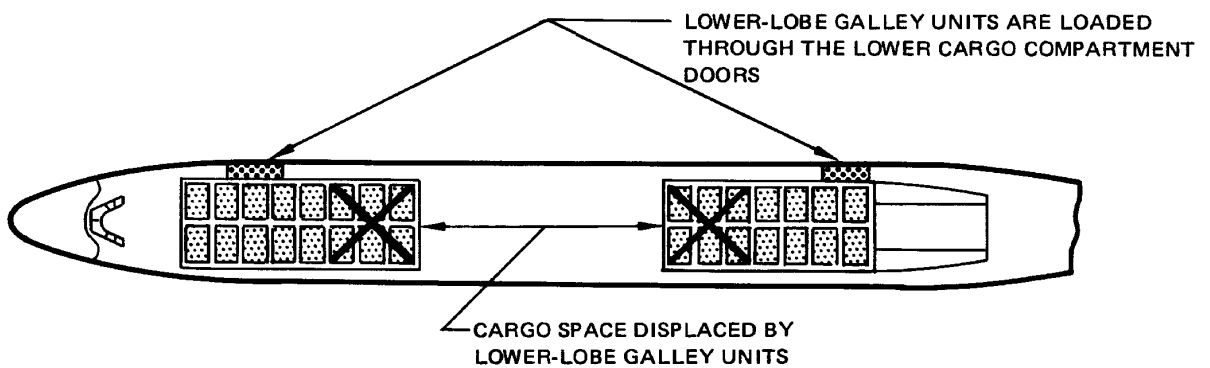
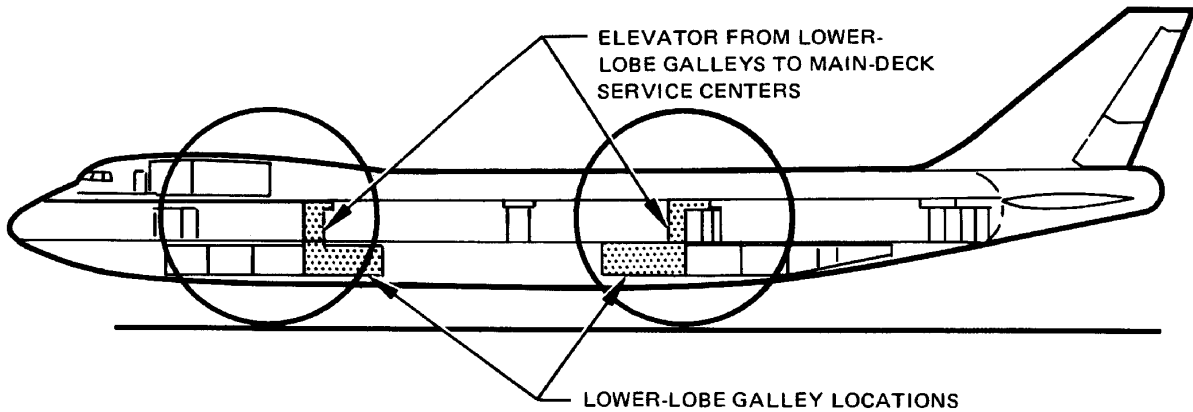

COMPARISON OF CARGO VOLUME WITH/WITHOUT LOWER-LOBE GALLEYS		
	WITH MAIN-DECK GALLEYS	WITH LOWER-LOBE GALLEYS
NUMBER OF CONTAINERS	30	18
CONTAINER VOL—CU FT (CU M)	5,190 (147)*	3,114 (88.2)*
BULK CARGO VOL—CU FT (CU M)	1,000 (28.3)**	1,000 (28.3)**
TOTAL VOL: CU FT (CU M)	6,190 (175.3)	4,114 (116)

* CONTAINER DATA FROM SEC 2.6.1.
 ** 800 CU FT (22.6 CU M) ON 747-200C AND COMBI

2.6.3 LOWER CARGO COMPARTMENTS — LOWER-LOBE GALLEY OPTION
 MODELS 747-100B, -200B, -200C

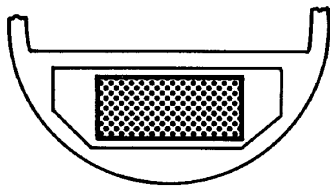
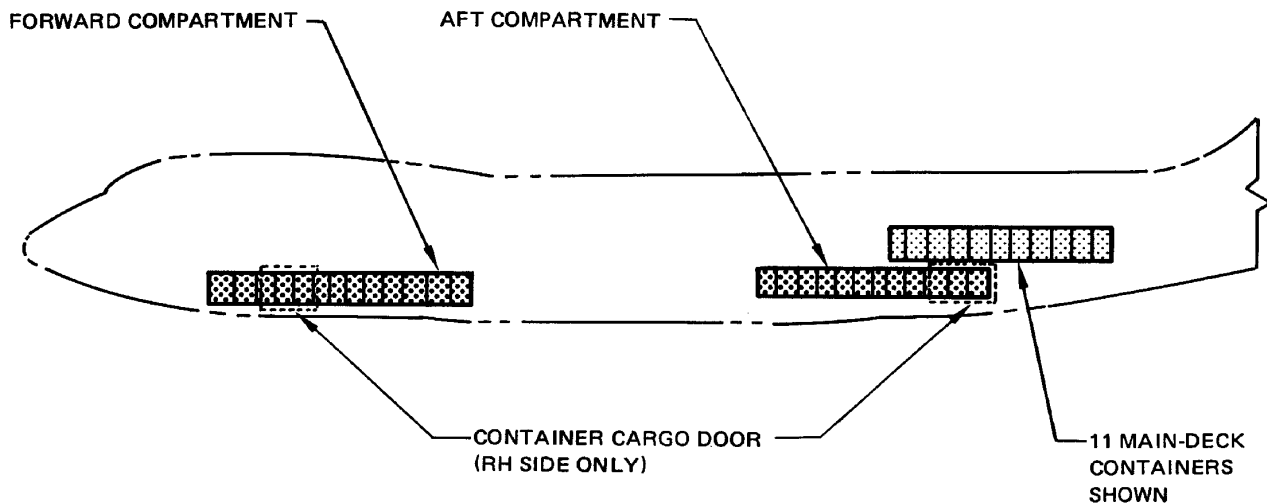

CONTAINER DATA:

SIZE: 38 IN. (0.97M) WIDE, 125 IN. (3.2M)
 LONG, 64 IN. (1.6M) HIGH
 INTERNAL VOLUME: 162 CU FT (4.6 CU M)
 CONTAINER WEIGHT: 380 LB (172 KG)
 WEIGHT LIMITATION: 1,753 LB (795 KG)
 PAYLOAD: 1,373 LB (622 KG)

MAIN DECK CONTAINERS IN LOWER CARGO COMPARTMENTS

AIRPLANE MODEL	CARGO COMPARTMENT	NUMBER OF CONTAINERS	MAX VOLUME CU FT (CU M)	MAX PAYLOAD LB (KG)
747-100B, -200, -300	FWD	12	1,944 (55)	16,476 (7,472)
	AFT	11	1,782 (51)	15,103 (6,849)
747SP	FWD	7	1,134 (32)	9,611 (4,359)
	AFT	7	1,134 (32)	9,611 (4,359)

2.6.4 LOWER CARGO COMPARTMENTS — OPTIONAL MAIN DECK CONTAINERS
MODEL 747

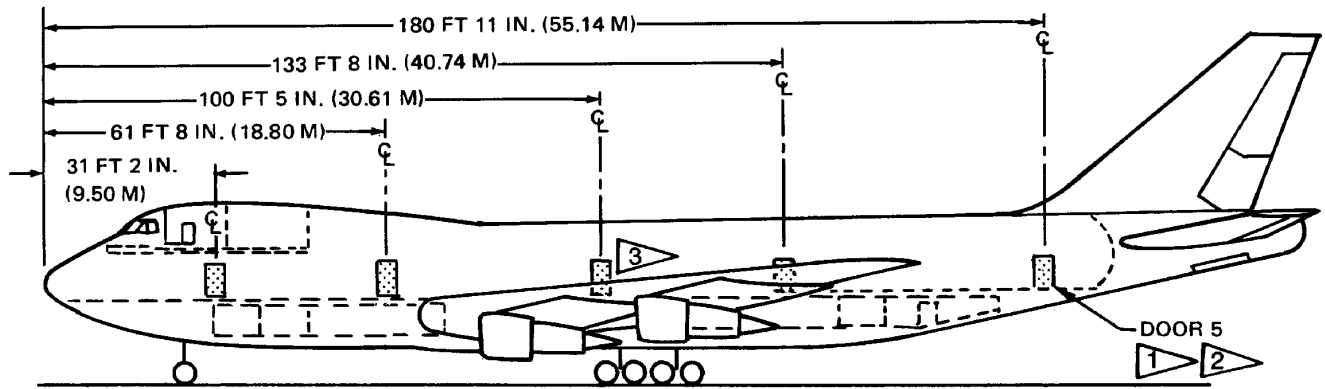

- NOTES:
- 1 10 PASSENGER DOORS — 5 EACH SIDE
DOOR OPENING SIZE = 42 BY 76 IN. (1.07 BY 1.93 M)
OVERALL DOOR SIZE = 47 BY 76 IN. (1.19 BY 1.93 M).
 - 2 SEE SEC. 2.3 FOR DOOR SILL HEIGHTS.
 - 3 CERTAIN MODELS HAVE NO. 3 DOORS DEACTIVATED.

MODELS 747-100B, -200B, -200C, -300

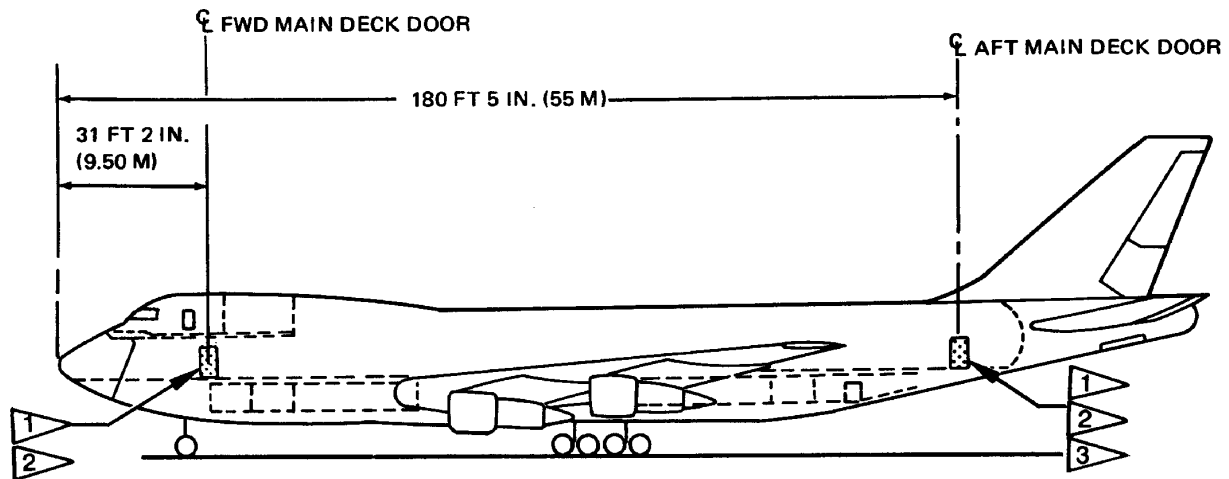

- NOTES:
- 1 LH SIDE ONLY
 - 2 DOOR OPENING SIZE—42 BY 76 IN. (1.07 BY 1.93 M)
OVERALL DOOR SIZE—47 BY 76 IN. (1.19 BY 1.93 M)
 - 3 SEE SEC 2.3 FOR DOOR SILL HEIGHTS.

MODEL 747-200F

2.7.1 DOOR CLEARANCES — MAIN ENTRY DOOR LOCATIONS
MODELS 747-100B, -200, -300

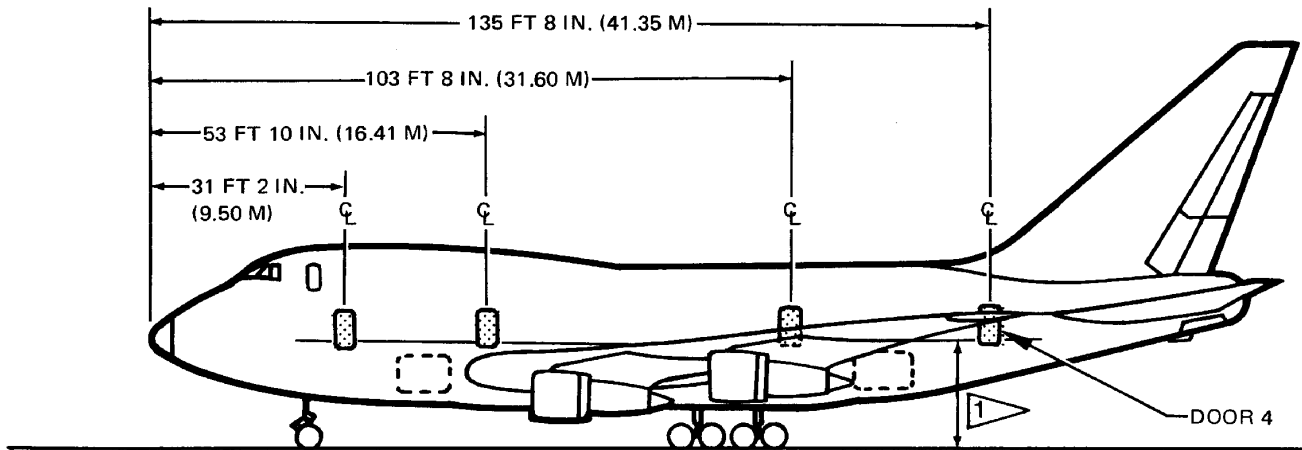

8 PASSENGER DOORS—4 EACH SIDE

DOOR OPENING SIZE = 42 BY 76 IN. (1.07 BY 1.93 M)
 OVERALL DOOR SIZE = 47 BY 76 IN. (1.19 BY 1.93 M)

 SEE SEC 2.3 FOR DOOR SILL HEIGHTS

2.7.2 DOOR CLEARANCES — MAIN ENTRY DOOR LOCATIONS
MODEL 747SP

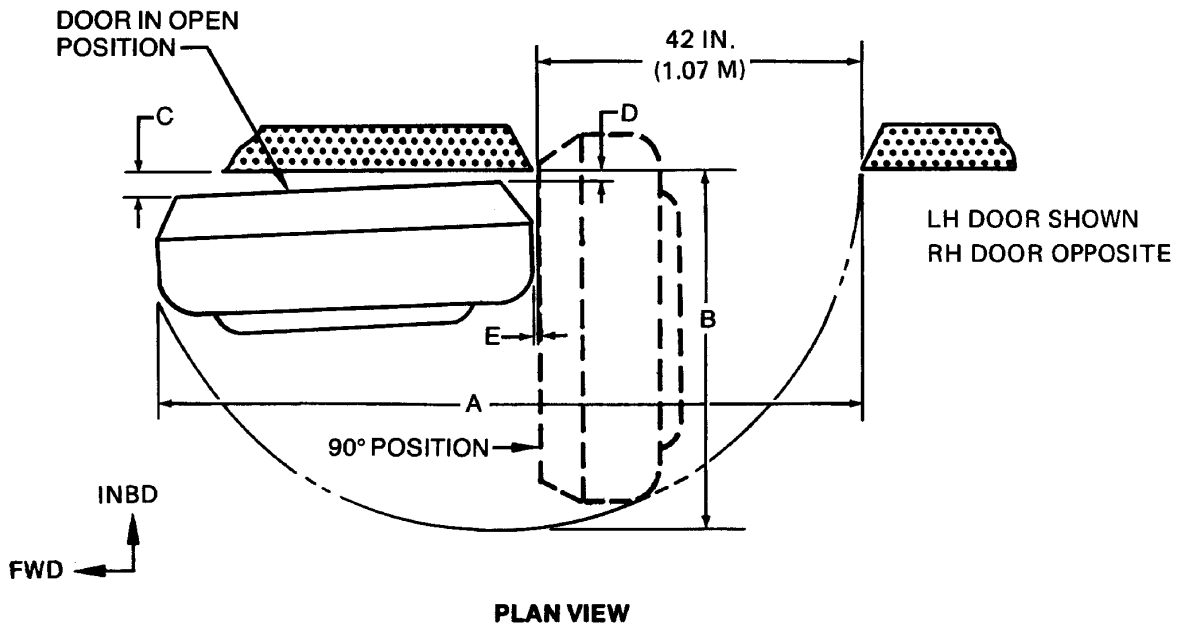

	DOOR NUMBER			
EXCEPT 747SP AND -200F	1	2	3	4
747SP	1	2	—	3 & 4
747-200F	1	—	—	—
A	7 FT 6 IN.	7 FT 6 IN.	7 FT 6 IN.	7 FT 6 IN.
	2.28 M	2.28 M	2.28 M	2.28 M
B	3 FT 9 IN.	3 FT 10 IN.	3 FT 10 IN.	3 FT 10 IN.
	1.1 M	1.2 M	1.2 M	1.2 M
C	4 IN.	3 IN.	3 IN.	3 IN.
	0.10 M	0.075 M	0.075 M	0.075 M
D	1 IN.	1 IN.	1 IN.	1 IN.
	0.025 M	0.025 M	0.025 M	0.025 M
E	1 IN.	1 IN.	1 IN.	1 IN.
	0.025 M	0.025 M	0.025 M	0.025 M

- MEASURED AT DOOR OPENING CENTERLINE AT DOOR SILL LEVEL AT 90° FROM AIRPLANE CENTERLINE.
- LH SIDE ONLY.
- CERTAIN AIRPLANES HAVE NO. 3 DOORS DEACTIVATED.







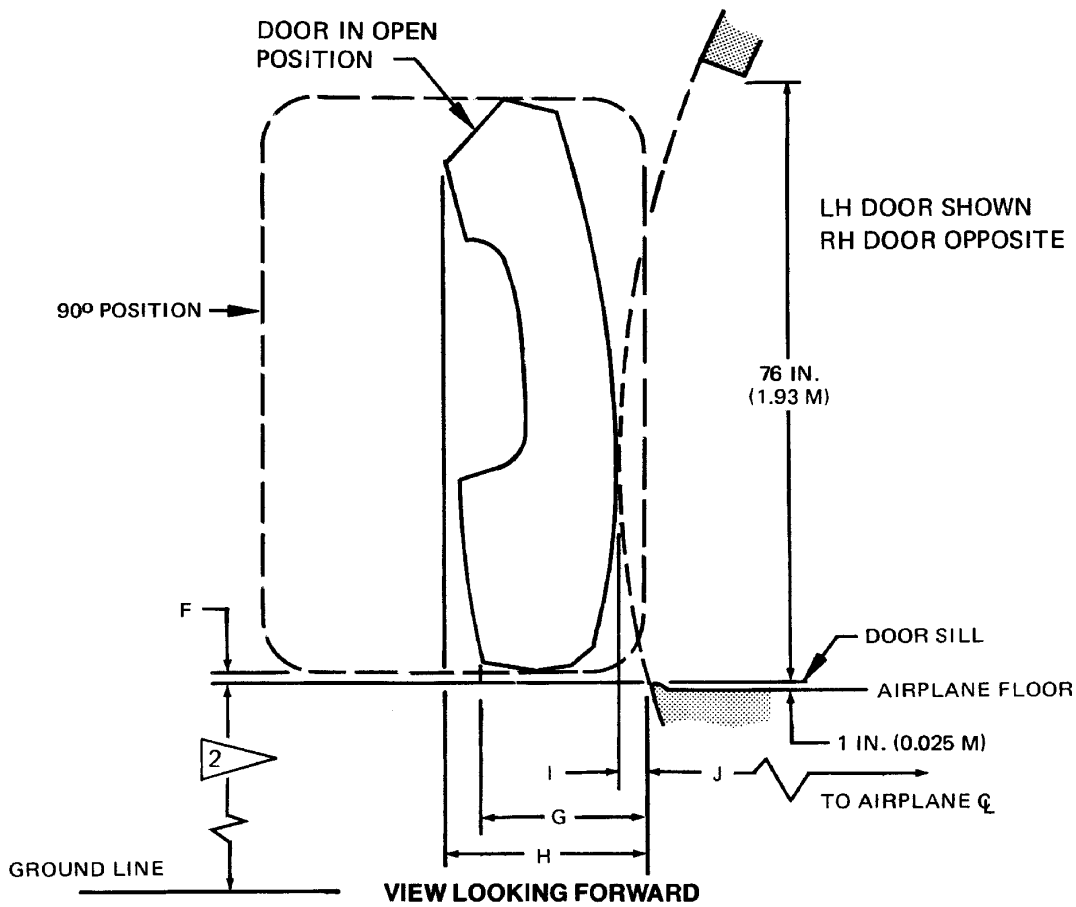

2.7.3 DOOR CLEARANCES — MAIN ENTRY DOORS 1-4 (PLAN VIEW) MODEL 747

D6-58326

MAY 1984

45



	DOOR NUMBER			
	1	2	3 	4
EXCEPT 747 SP AND -200F	1	2	3 	4
747SP	1	2	—	3 & 4
747-200F	1 	—	—	—
F 	2 IN.	2 IN.	2 IN.	2 IN.
	0.05 M	0.05 M	0.05 M	0.05 M
G 	1 FT 7 IN.	1 FT 10 IN.	1 FT 5 IN.	1 FT 10 IN.
	0.5 M	0.6 M	0.6 M	0.6 M
H 	1 FT 11 IN.	2 FT	1 FT 9 IN.	2 FT
	0.6 M	0.6 M	0.5 M	0.6 M
I 	1 IN.	3 IN.	0	3 IN.
	0.025 M	0.075 M	0	0.075 M
J 	9 FT 6 IN.	10 FT 5 IN.	10 FT 8 IN.	10 FT 5 IN.
	2.9 M	3.18 M	3.25 M	3.18 M

 MEASURED AT DOOR OPENING CENTERLINE AT DOOR SILL LEVEL AT 90° FROM AIRPLANE CENTERLINE.

 SEE SEC. 2.3 FOR DOOR SILL HEIGHTS.

 LH SIDE ONLY.

 CERTAIN AIRPLANES HAVE NO. 3 DOORS DEACTIVATED.

2.7.4 DOOR CLEARANCES — MAIN ENTRY DOORS 1-4 ENVELOPE (ELEVATION VIEW) MODEL 747

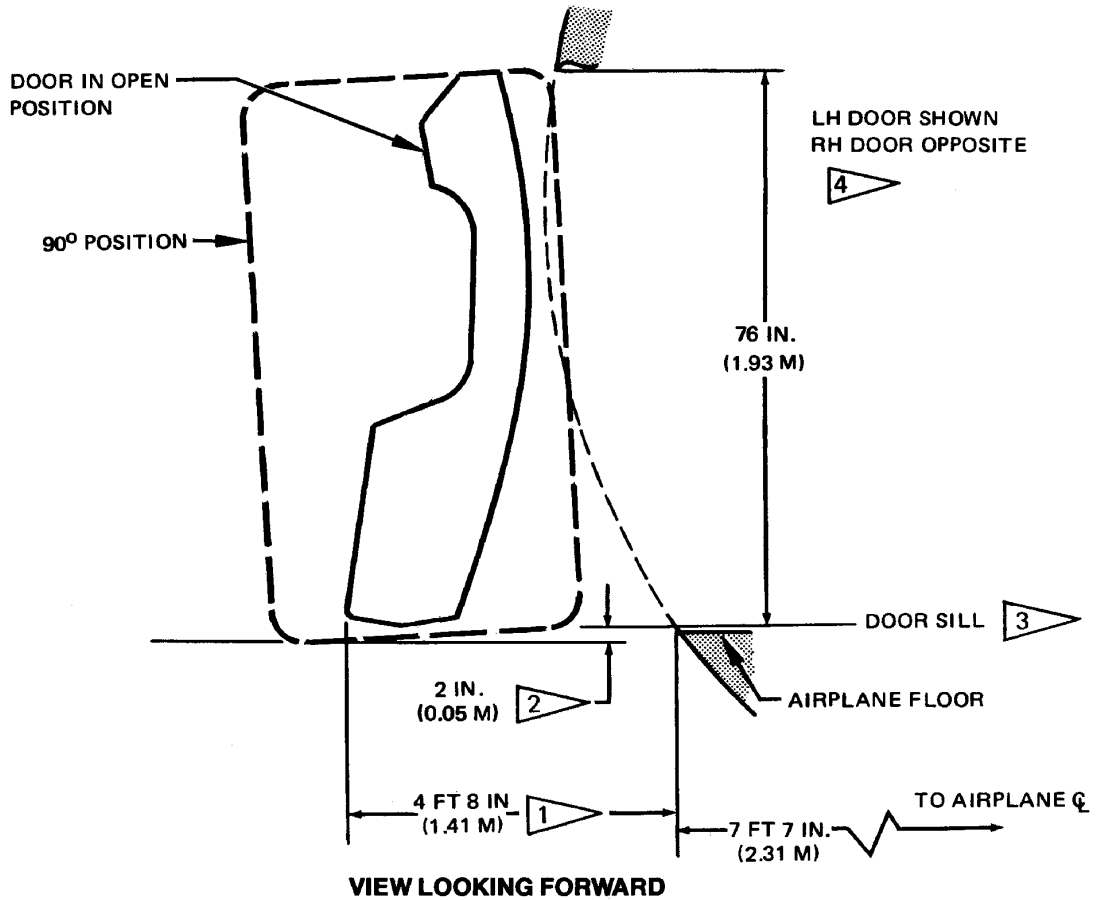
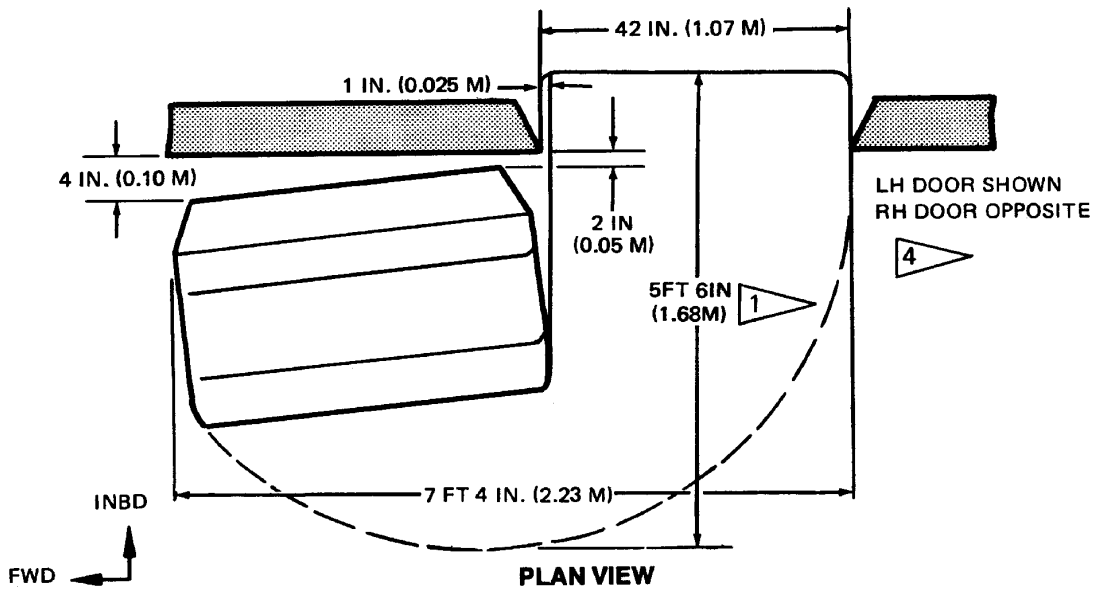

- 1 MEASURED AT DOOR OPENING CENTERLINE AT DOOR SILL LEVEL AT 90° FROM AIRPLANE CENTERLINE
- 2 DOOR HINGE IS INCLINED 3 DEG FROM VERTICAL.
- 3 SEE SEC. 2.3 FOR DOOR SILL HEIGHTS.
- 4 LH DOOR ONLY ON 747-200F.

2.7.5 DOOR CLEARANCES — MAIN ENTRY DOOR NUMBER 5
MODELS 747-100B, -200, -300

D6-58326

MAY 1984

47

NOTE: RH DOOR SHOWN, LH DOOR OPPOSITE

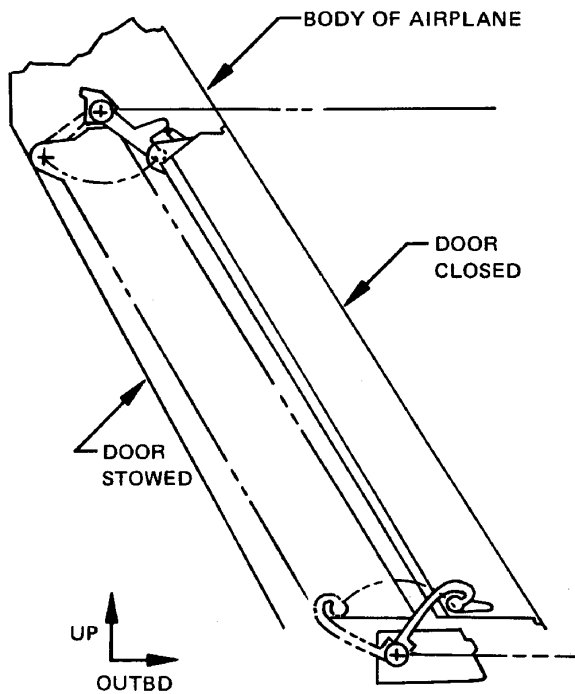
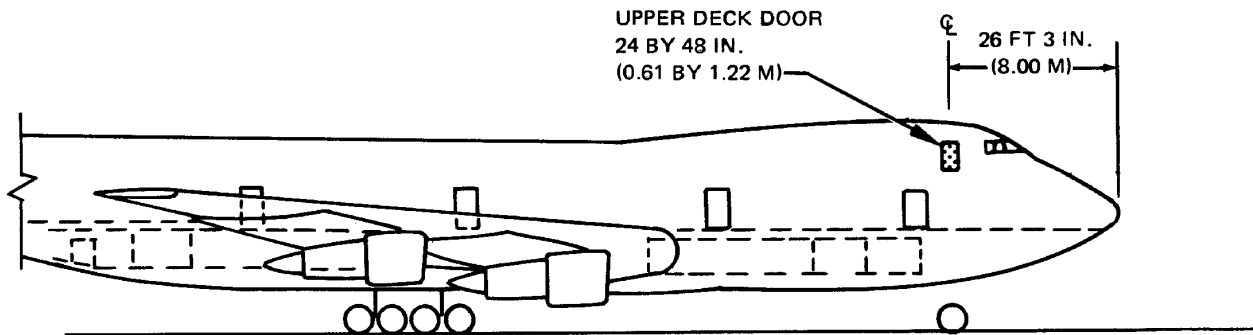

VIEW LOOKING FORWARD

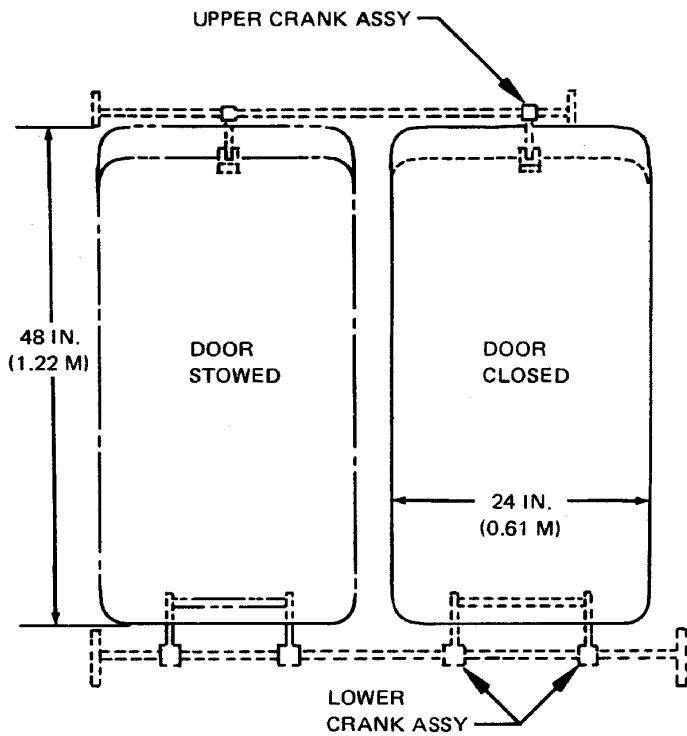

RH SIDE VIEW
(SEE NOTE ABOVE)

2.7.6 DOOR CLEARANCES — UPPER DECK EXIT DOOR
MODELS 747-100B, -200, SP

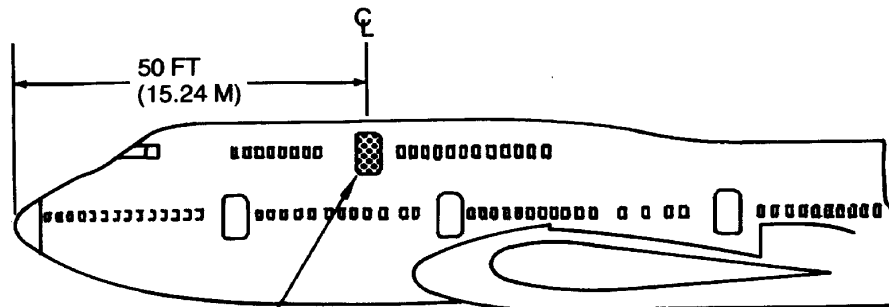

UPPER DECK DOOR
 CLEAR RECTANGULAR
 OPENING
 42 BY 72 IN (1.07 BY 1.83 M)
 LH SHOWN, RH SIMILAR

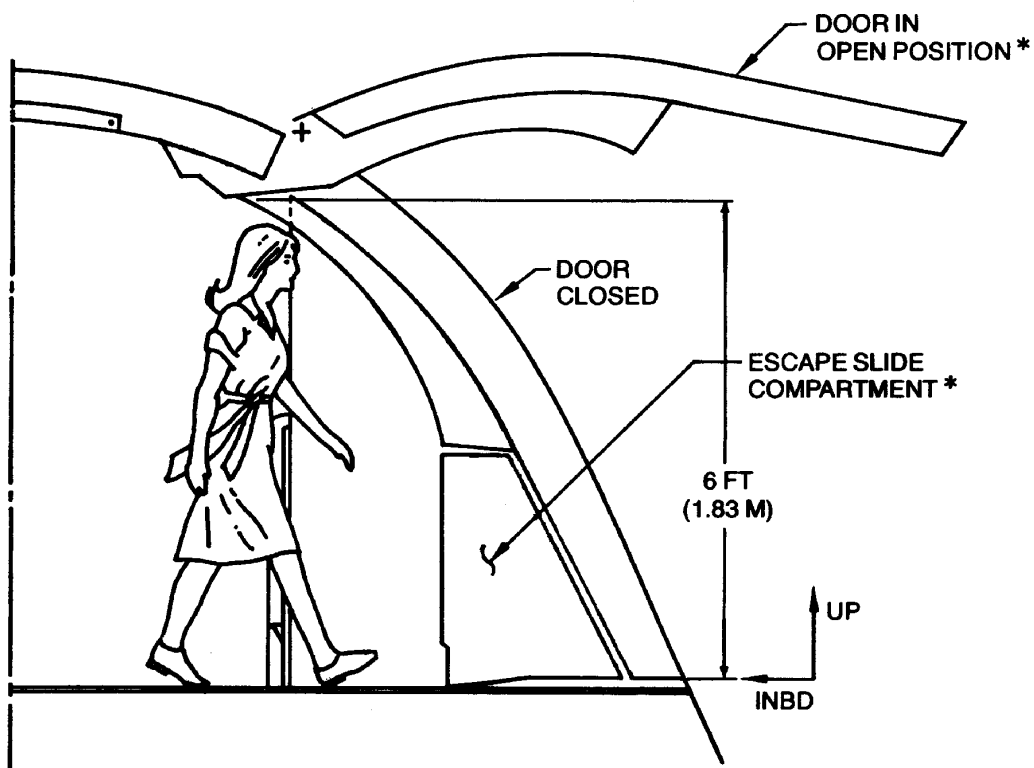

NOTE:
 * ESCAPE SLIDE IS AUTOMATICALLY DEPLOYED WHEN DOOR
 IS OPENED.

**2.7.7 DOOR CLEARANCES — UPPER DECK EMERGENCY EXIT DOOR
 MODEL 747-300**

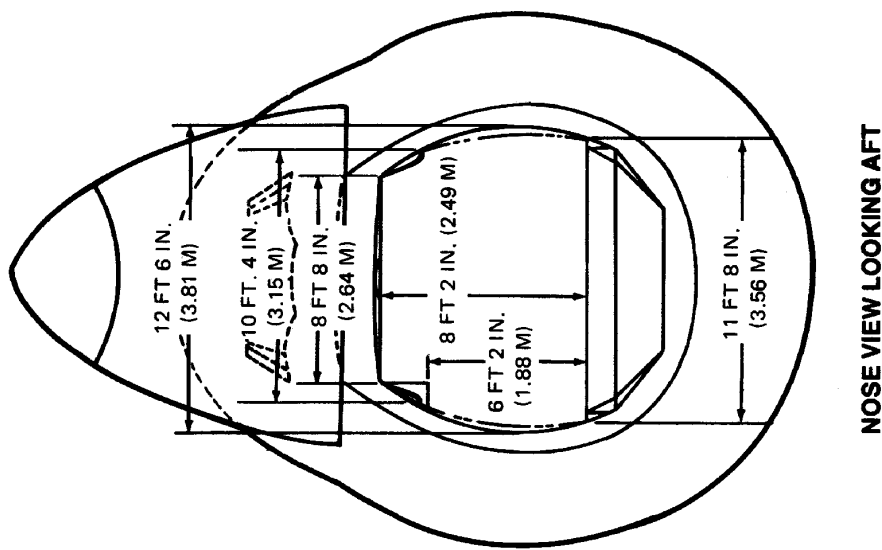
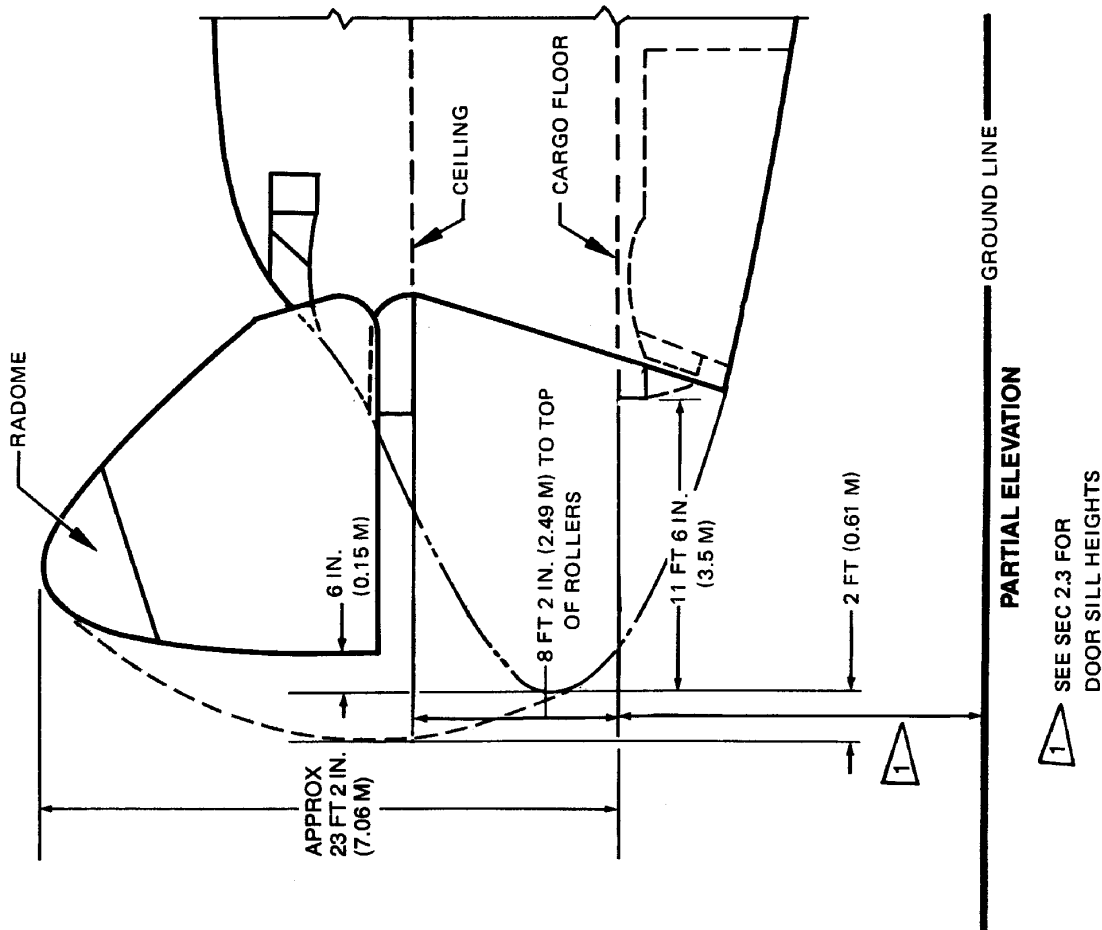

2.7.8 DOOR CLEARANCES — NOSE CARGO DOOR
MODELS 747-200C, -200F

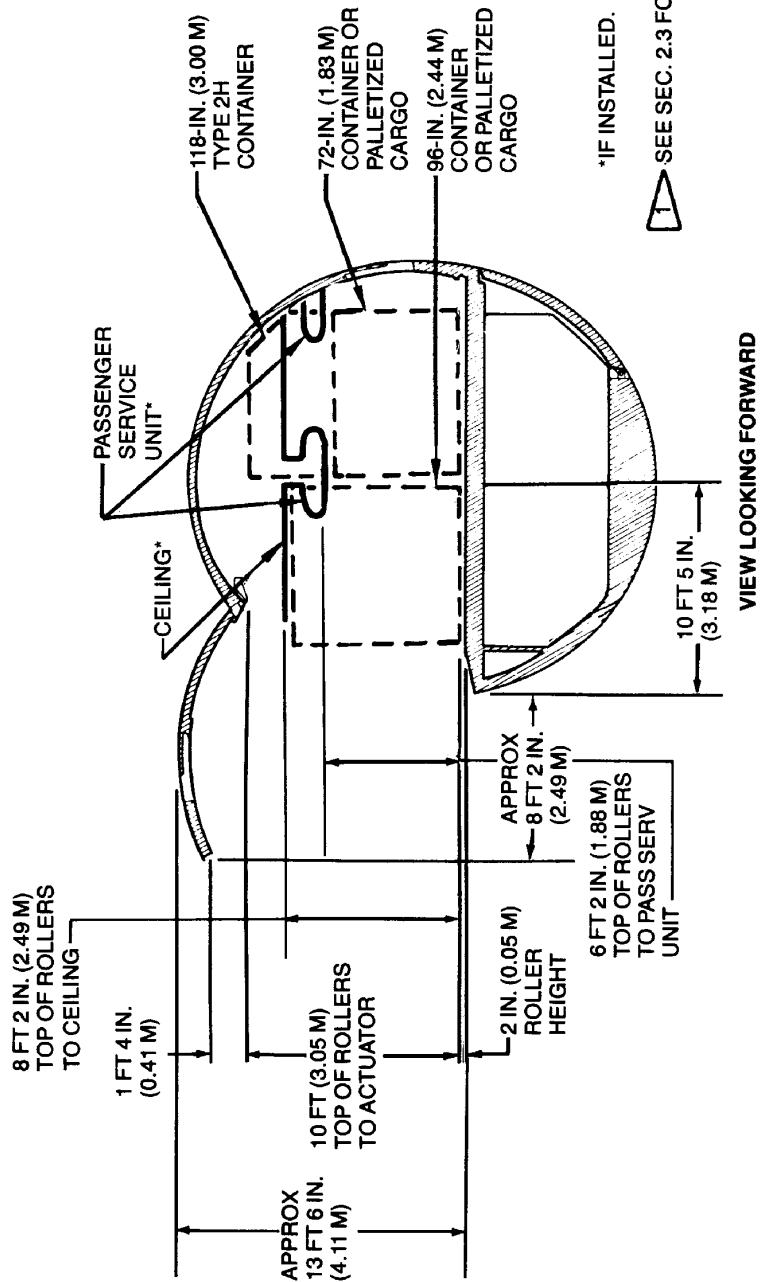
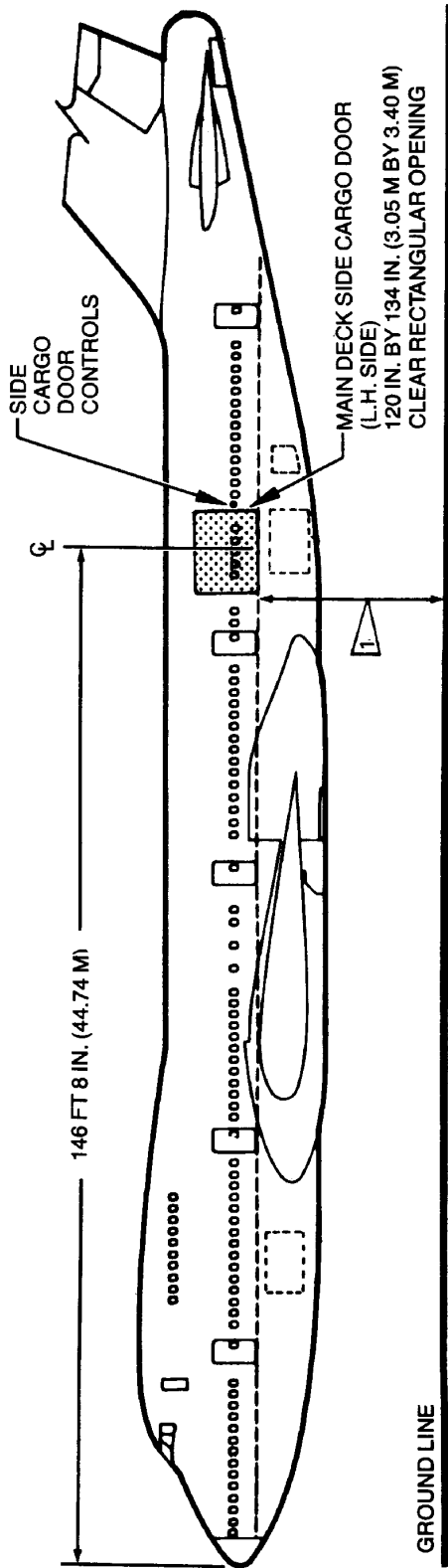

2.7.9 DOOR CLEARANCES — OPTIONAL MAIN DECK CARGO DOOR
MODELS 747-100SF, -200B COMBI, -200C, -200F, -300 COMBI

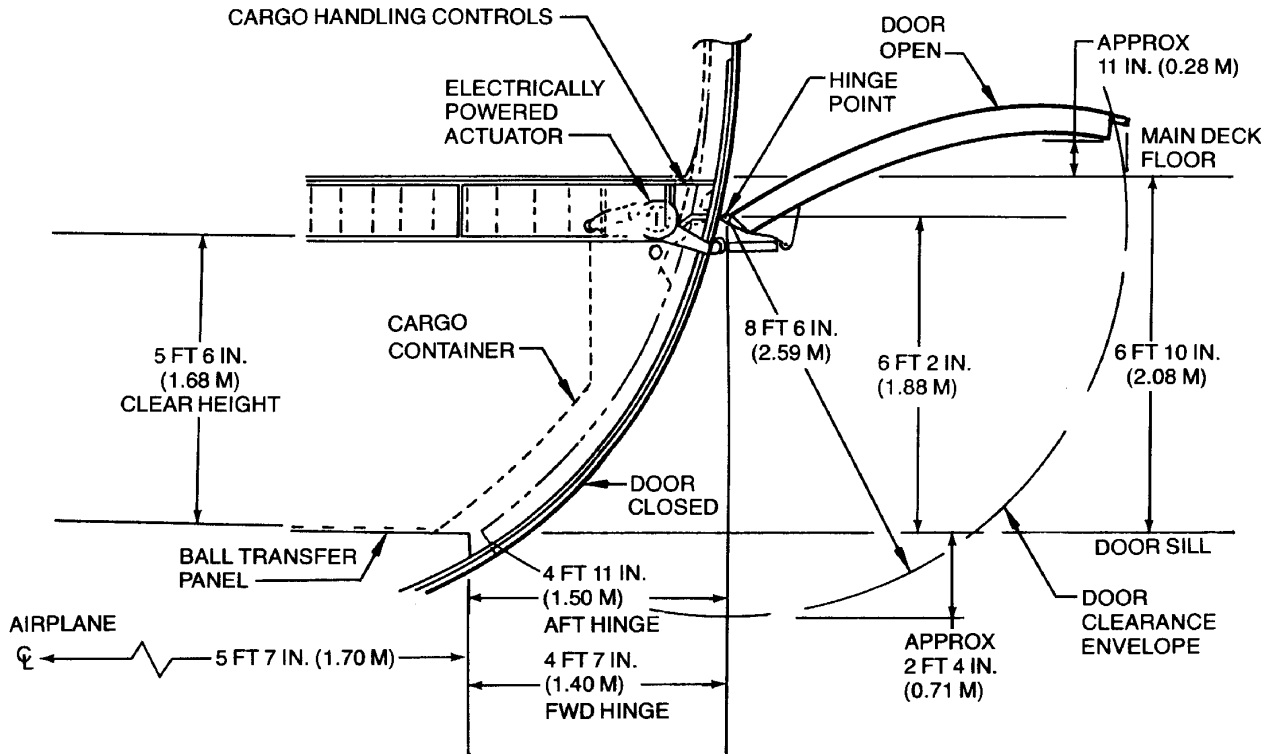
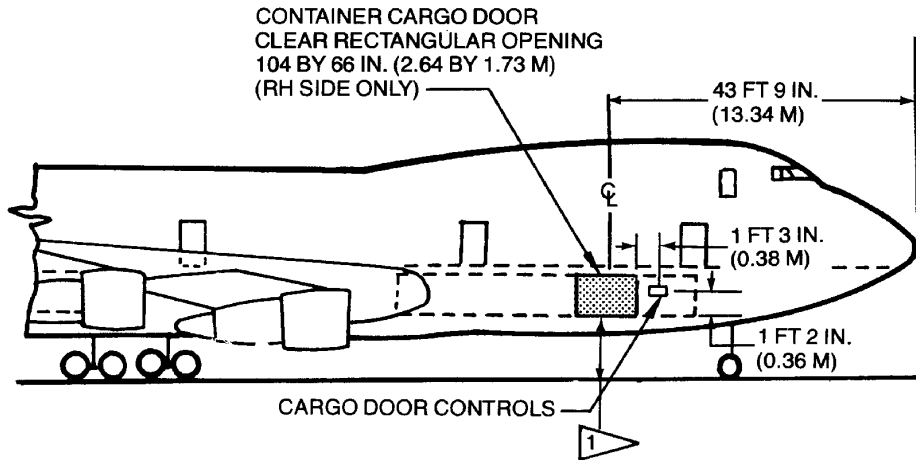

CONTAINER CARGO DOOR—VIEW LOOKING FORWARD

1 SEE SEC. 2.3 FOR DOOR SILL HEIGHTS.

2.7.10 DOOR CLEARANCES — LOWER FORWARD CARGO COMPARTMENT MODEL 747

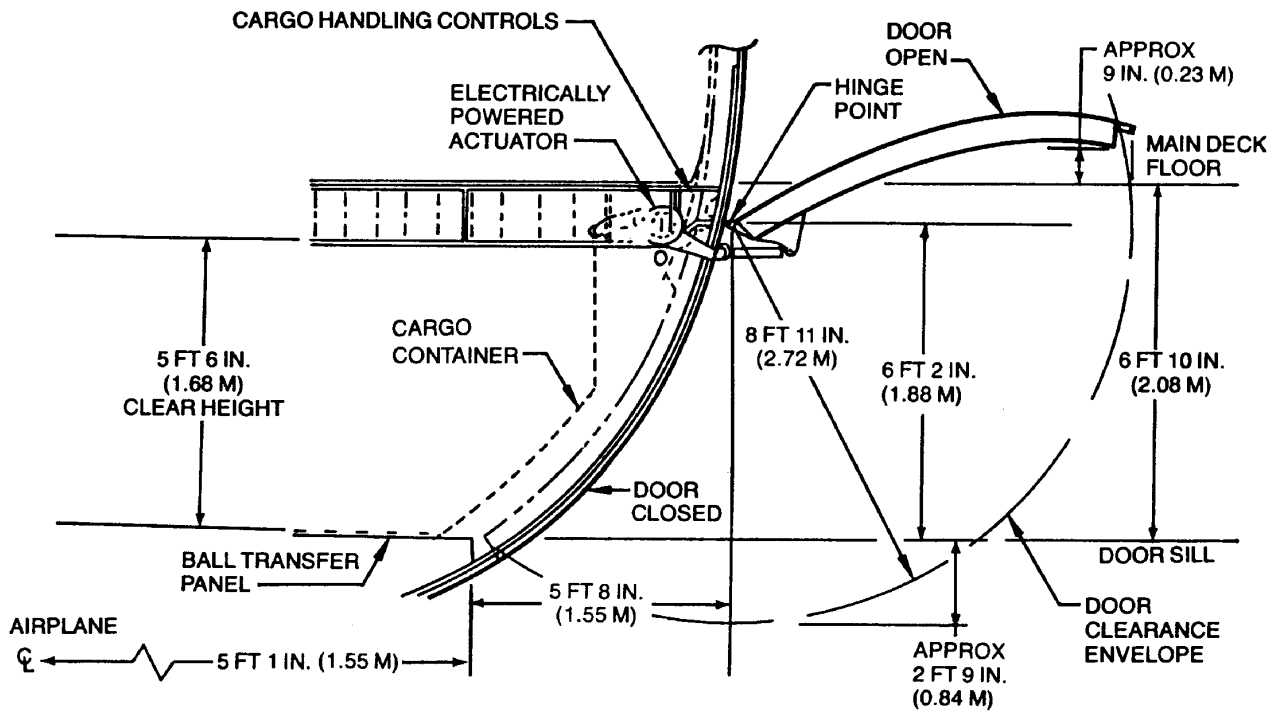
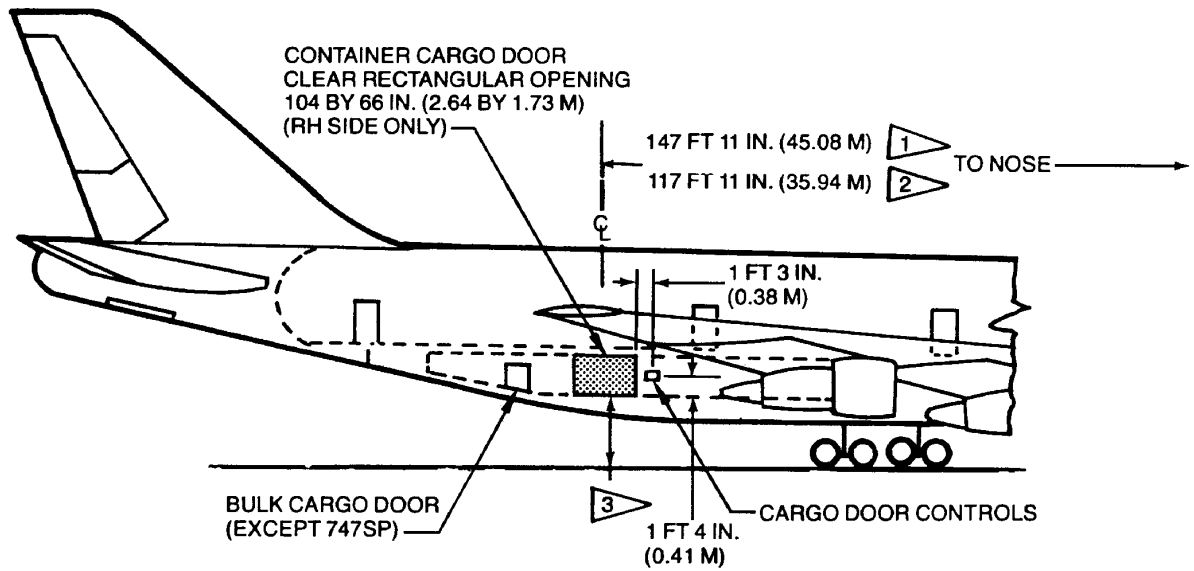

CONTAINER CARGO DOOR—VIEW LOOKING FORWARD

- 1 747-100B, -200, -300
- 2 747 SP
- 3 SEE SEC. 2.3 FOR DOOR SILL HEIGHTS.

**2.7.11 DOOR CLEARANCES — LOWER AFT CARGO COMPARTMENT
MODEL 747**

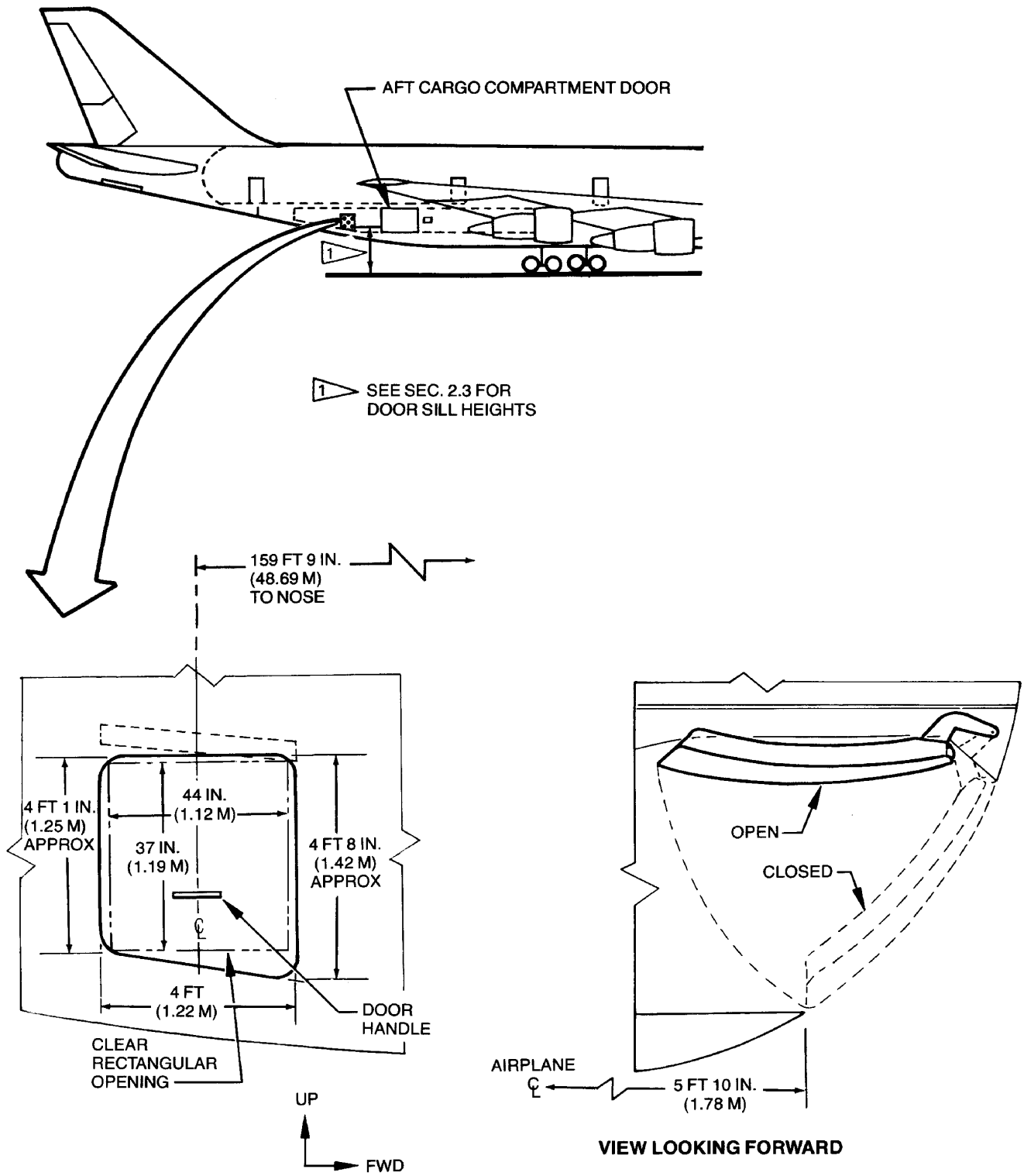

2.7.12 DOOR CLEARANCES — BULK CARGO COMPARTMENT
MODELS 747-100B, -200, -300

3.0 AIRPLANE PERFORMANCE

3.1 General Information

3.2 Payload/Range for Long-Range Cruise

3.3 F.A.R. Takeoff Runway Length Requirements

3.4 F.A.R. Landing Runway Length Requirements

3.0 AIRPLANE PERFORMANCE

3.1 General Information

The graphs in Section 3.2 provide information on Operational Empty Weight (OEW) payload, trip range, brake-release gross weight, and fuel limits for airplane models with different engines. To use these graphs, if the trip range and zero-fuel weight (OEW + payload) are known, the approximate brake-release weight can be found, limited by fuel quantity. Examples of loading conditions under certain OEW's are illustrated in each graph. These graphs were developed to determine various parameters under different OEW's.

The graphs in Section 3.3. provide information on takeoff runway length requirements for airplanes with different engines and takeoff weights at different pressure altitudes. Maximum takeoff weights shown on the graphs are the heaviest for the particular airplane models with the corresponding engines. Standard day temperatures for pressure altitudes shown on the F.A.R. graphs are given below:

PRESSURE ALTITUDE		STANDARD-DAY TEMP	
FEET	METERS	°F	°C
0	0	59.0	15.00
2,000	610	51.9	11.04
4,000	1,219	44.7	7.06
6,000	1,829	37.6	3.11
8,000	2,438	30.5	-0.85
10,000	3,048	23.3	-4.81

The graphs in Section 3.4 provide information on landing runway length requirements for different weights and altitudes. The maximum landing weights shown are the heaviest for the particular airplane model.

NOTES:

- STANDARD DAY, ZERO WIND
- LRC AT 31-35-39,000 FT STEP CRUISE
- TWO AIR-CONDITIONING PACKS ON DURING CRUISE
- RESERVES PER F.A.R. 121.645(a) AND ATA (OCT. 1967) INT'L RULES
- MAXIMUM ENGINE INJECTION WATER IS 3,000 LB (1,362 KG)
- CONSULT USING AIRLINE FOR SPECIFIC OPERATING PROCEDURE AND OEW PRIOR TO FACILITY DESIGN

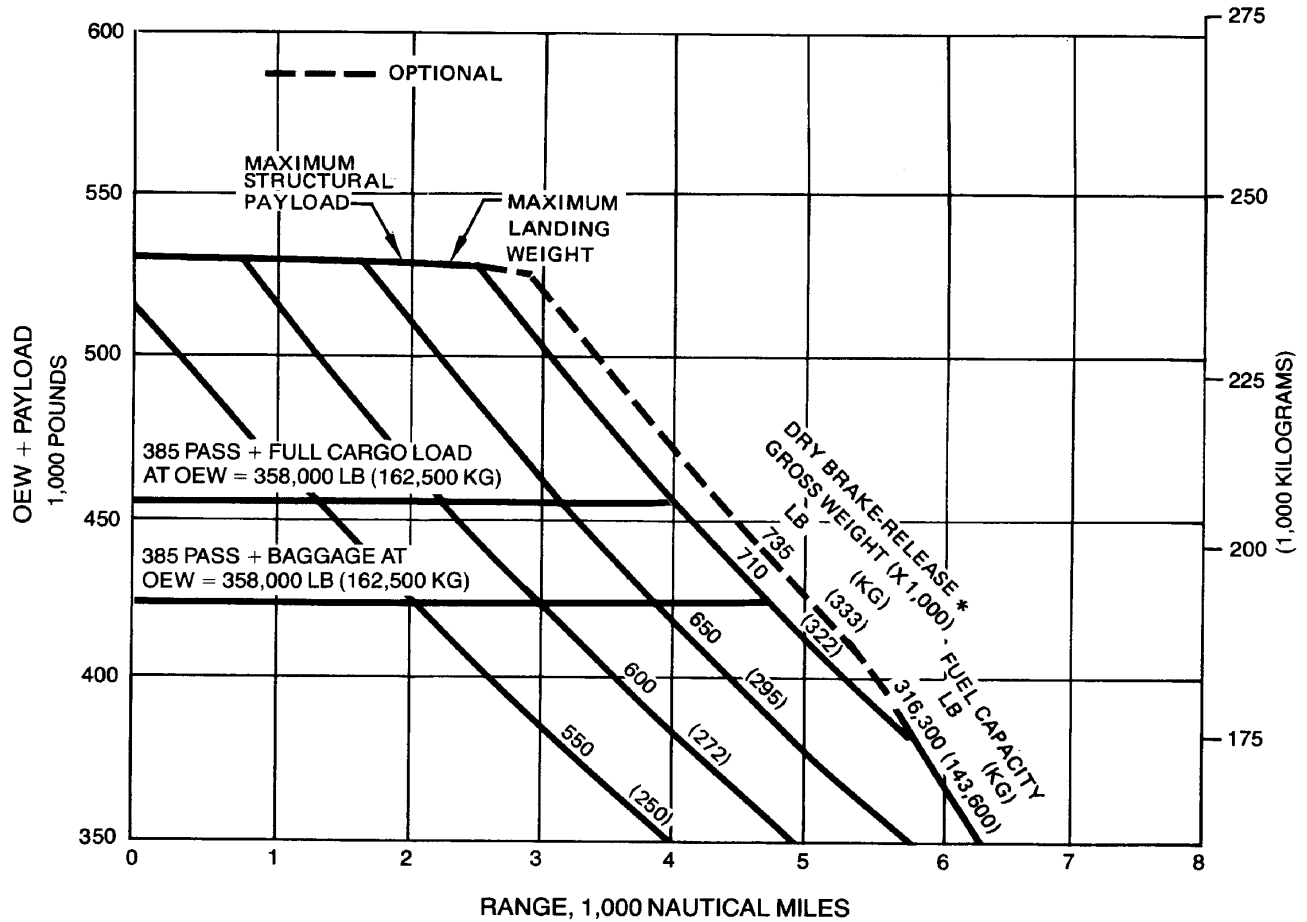

* FOR JT9D-3AW ENGINES, SUBTRACT WATER WEIGHT FROM WET BRAKE-RELEASE WEIGHT AND ENTER CURVE WITH DRY BRAKE-RELEASE WEIGHT.

**3.2.1 PAYLOAD/RANGE FOR LONG-RANGE CRUISE
MODEL 747-100 (JT9D-3A, -3AW ENGINES)**

NOTES:

- STANDARD DAY, ZERO WIND
- LRC AT 31-35-39,000 FT STEP CRUISE
- TWO AIR-CONDITIONING PACKS ON DURING CRUISE
- RESERVES PER F.A.R. 121.645(b) AND ATA (OCT. 1967) INT'L RULES
- MAXIMUM ENGINE INJECTION WATER IS 5,000 LB (2,268 KG)
- CONSULT USING AIRLINE FOR SPECIFIC OPERATING PROCEDURE AND OEWS PRIOR TO FACILITY DESIGN
- FOR 747-300, REDUCE RANGE BY 1.5%

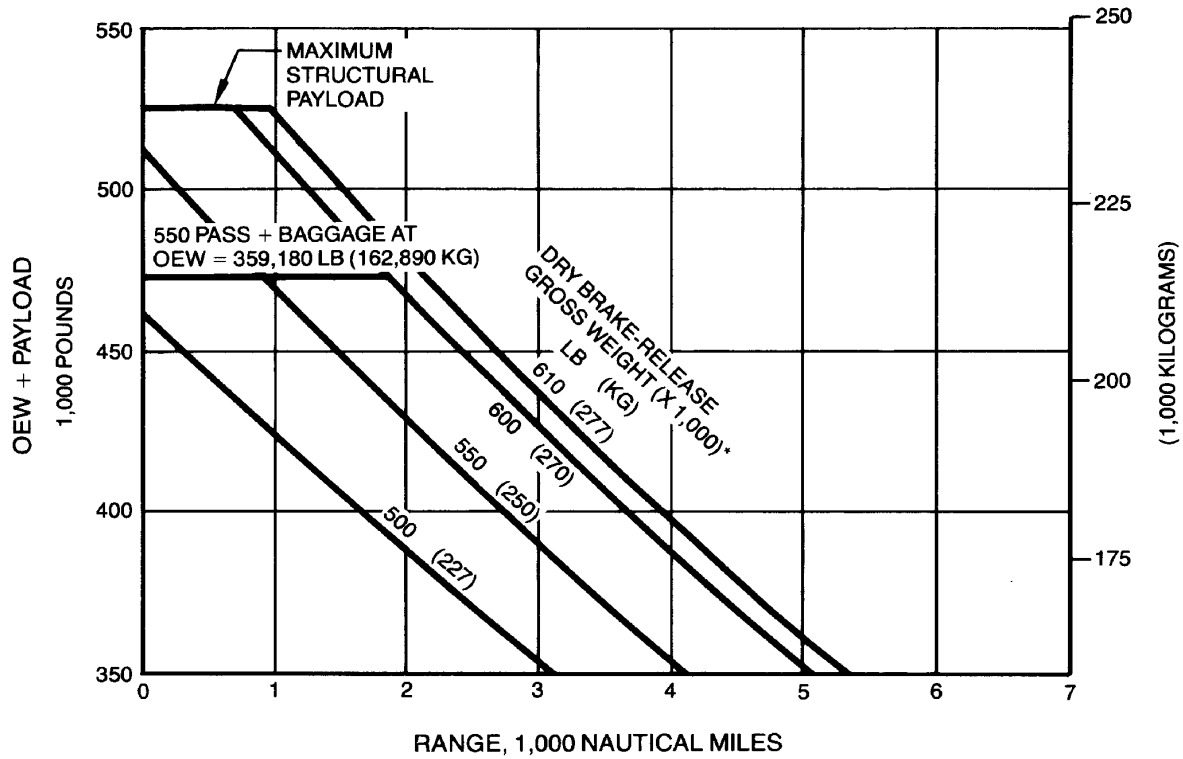

*FOR JT9D-7AW ENGINES, SUBTRACT WATER WEIGHT FROM WET BRAKE-RELEASE WEIGHT AND ENTER CURVE WITH DRY BRAKE-RELEASE WEIGHT.

3.2.2 PAYLOAD/RANGE FOR LONG-RANGE CRUISE
MODELS 747-100B SR, -300 SR (JT9D-7A, -7AW ENGINES)

NOTES:

- STANDARD DAY, ZERO WIND
- LRC AT 31-35-39,000 FT STEP CRUISE
- TWO AIR-CONDITIONING PACKS ON DURING CRUISE
- RESERVES PER F.A.R. 121.645(b) AND ATA (OCT. 1967) INT'L RULES
- CONSULT USING AIRLINE FOR SPECIFIC OPERATING PROCEDURE AND OEW PRIOR TO FACILITY DESIGN
- FOR 747-300, REDUCE RANGE BY 1.5%

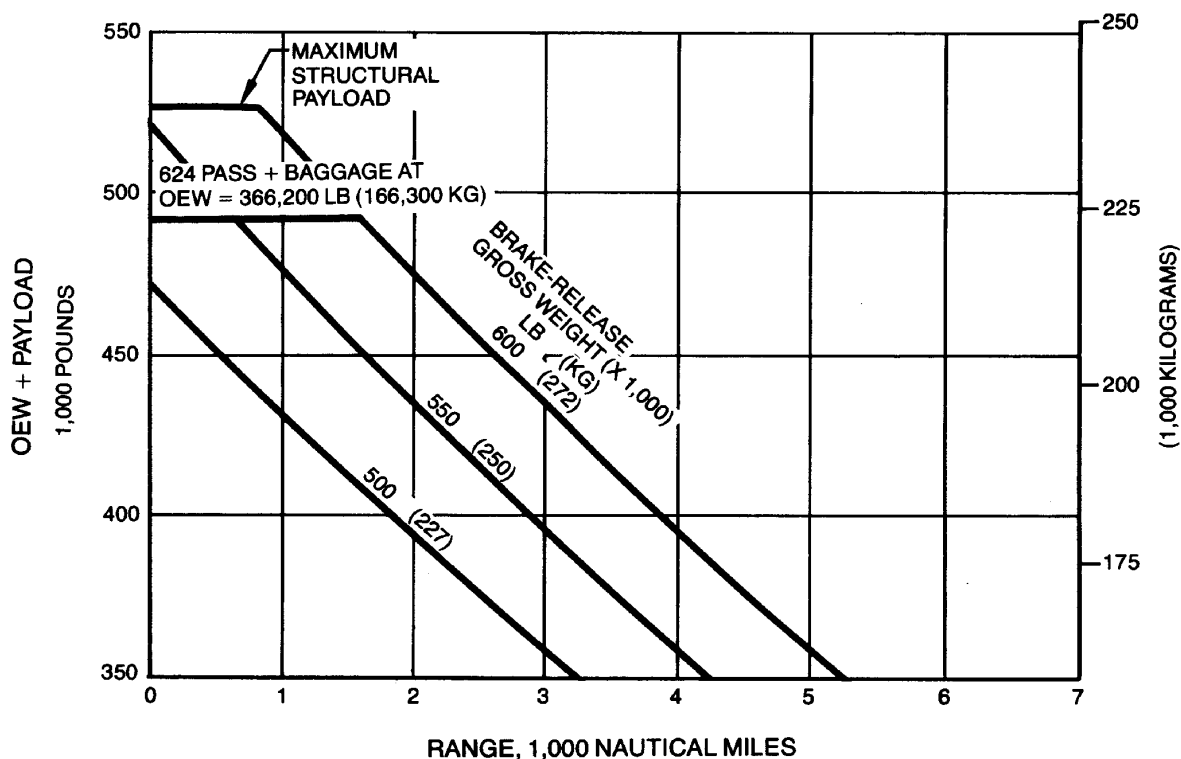

3.2.3 PAYLOAD/RANGE FOR LONG-RANGE CRUISE
MODELS 747-100B SR, -300 SR (CF6-45A2, -50E2 ENGINES)

NOTES:

- STANDARD DAY, ZERO WIND
- LRC AT 31-35-39,000 FT STEP CRUISE
- TWO AIR-CONDITIONING PACKS ON DURING CRUISE
- RESERVES PER F.A.R. 121.645(b) AND ATA (OCT. 1967) INT'L RULES
- MAXIMUM ENGINE INJECTION WATER IS 5,000 LB (2,268 KG)
- CONSULT USING AIRLINE FOR SPECIFIC OPERATING PROCEDURE AND OEW PRIOR TO FACILITY DESIGN

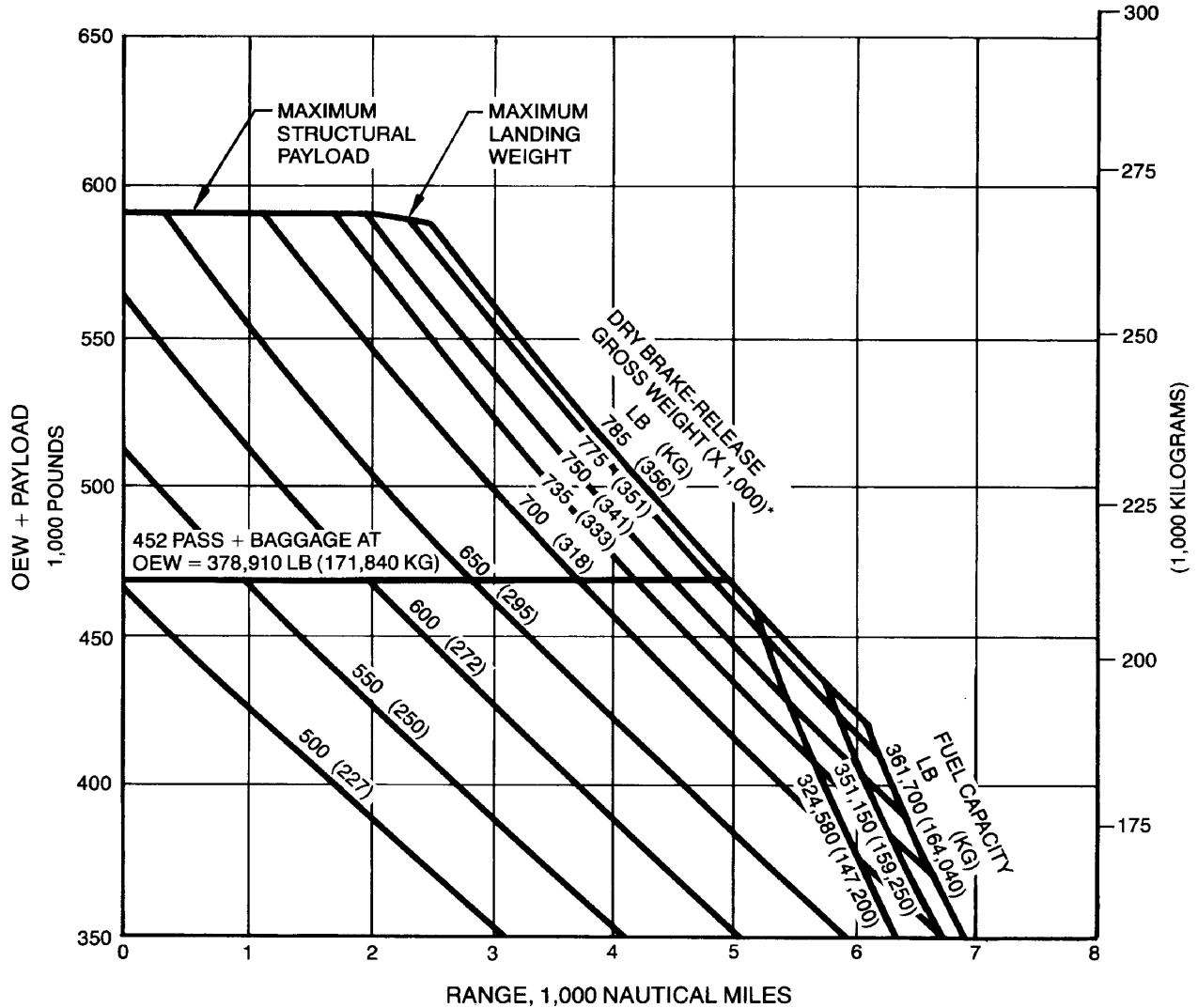

*FOR JT9D-7AW ENGINES, SUBTRACT WATER WEIGHT FROM WET BRAKE-RELEASE WEIGHT AND ENTER CURVE WITH DRY BRAKE-RELEASE WEIGHT

3.2.4 PAYLOAD/RANGE FOR LONG-RANGE CRUISE
MODELS 747-100B, -200 (JT9D-7A, -7AW ENGINES)

NOTES:

- STANDARD DAY, ZERO WIND
- LRC AT 31-35-39,000 FT STEP CRUISE
- TWO AIR-CONDITIONING PACKS ON DURING CRUISE
- RESERVES PER F.A.R. 121.645(b) AND ATA (OCT. 1967) INT'L RULES
- MAXIMUM ENGINE INJECTION WATER IS 5,000 LB (2,268 KG)
- CONSULT USING AIRLINE FOR SPECIFIC OPERATING PROCEDURE AND OEW PRIOR TO FACILITY DESIGN

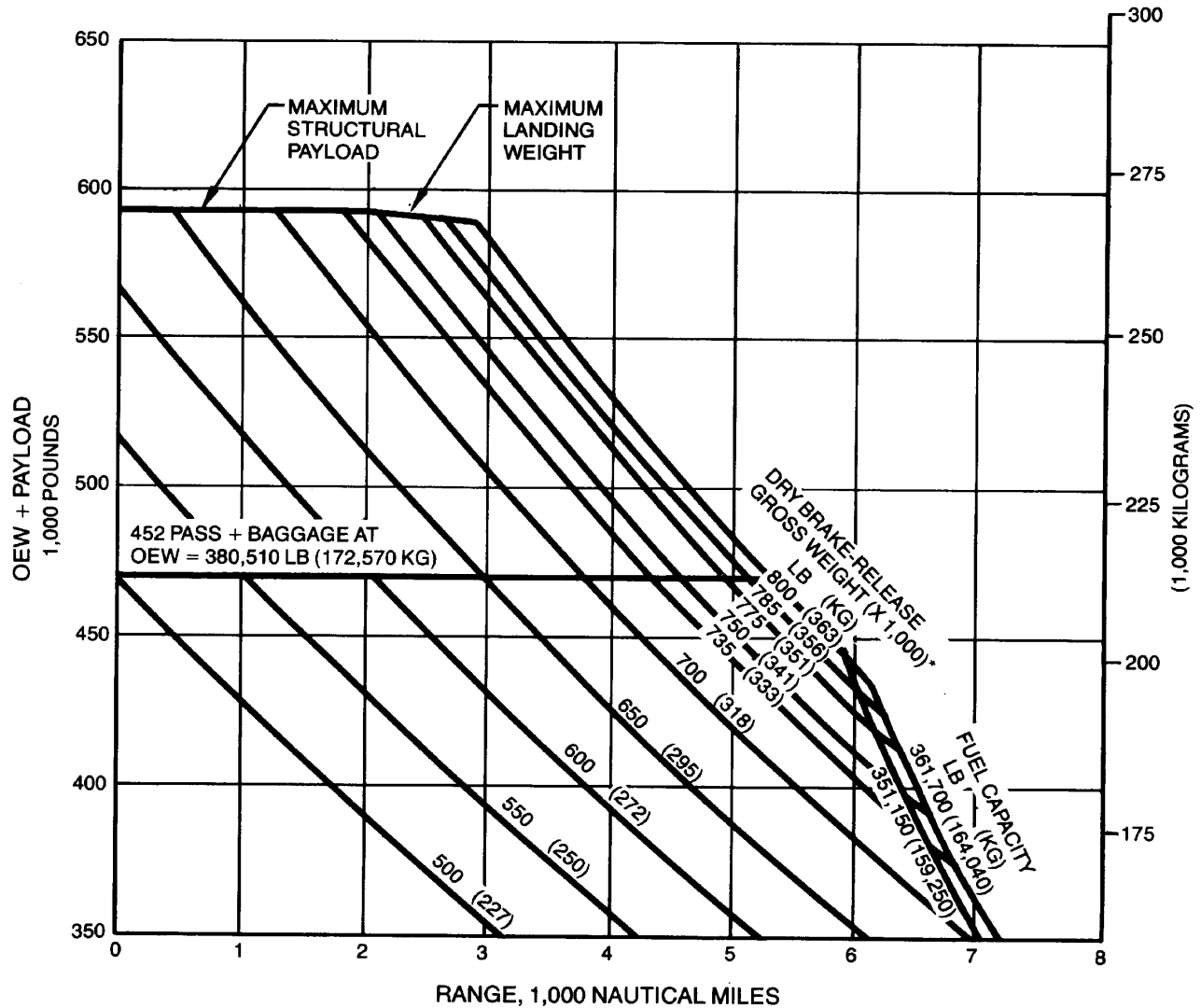

*FOR JT9D-7FW ENGINES, SUBTRACT WATER WEIGHT FROM WET BRAKE-RELEASE WEIGHT AND ENTER CURVE WITH DRY BRAKE-RELEASE WEIGHT

**3.2.5 PAYLOAD/RANGE FOR LONG-RANGE CRUISE
MODELS 747-100B, -200 (JT9D-7F, -7FW, -7J ENGINES)**

NOTES:

- STANDARD DAY, ZERO WIND
- LRC AT 31-35-39,000 FT STEP CRUISE
- TWO AIR-CONDITIONING PACKS ON DURING CRUISE
- RESERVES PER F.A.R. 121.645(b) AND ATA (OCT. 1967) INT'L RULES
- CONSULT USING AIRLINE FOR SPECIFIC OPERATING PROCEDURE AND OEW PRIOR TO FACILITY DESIGN

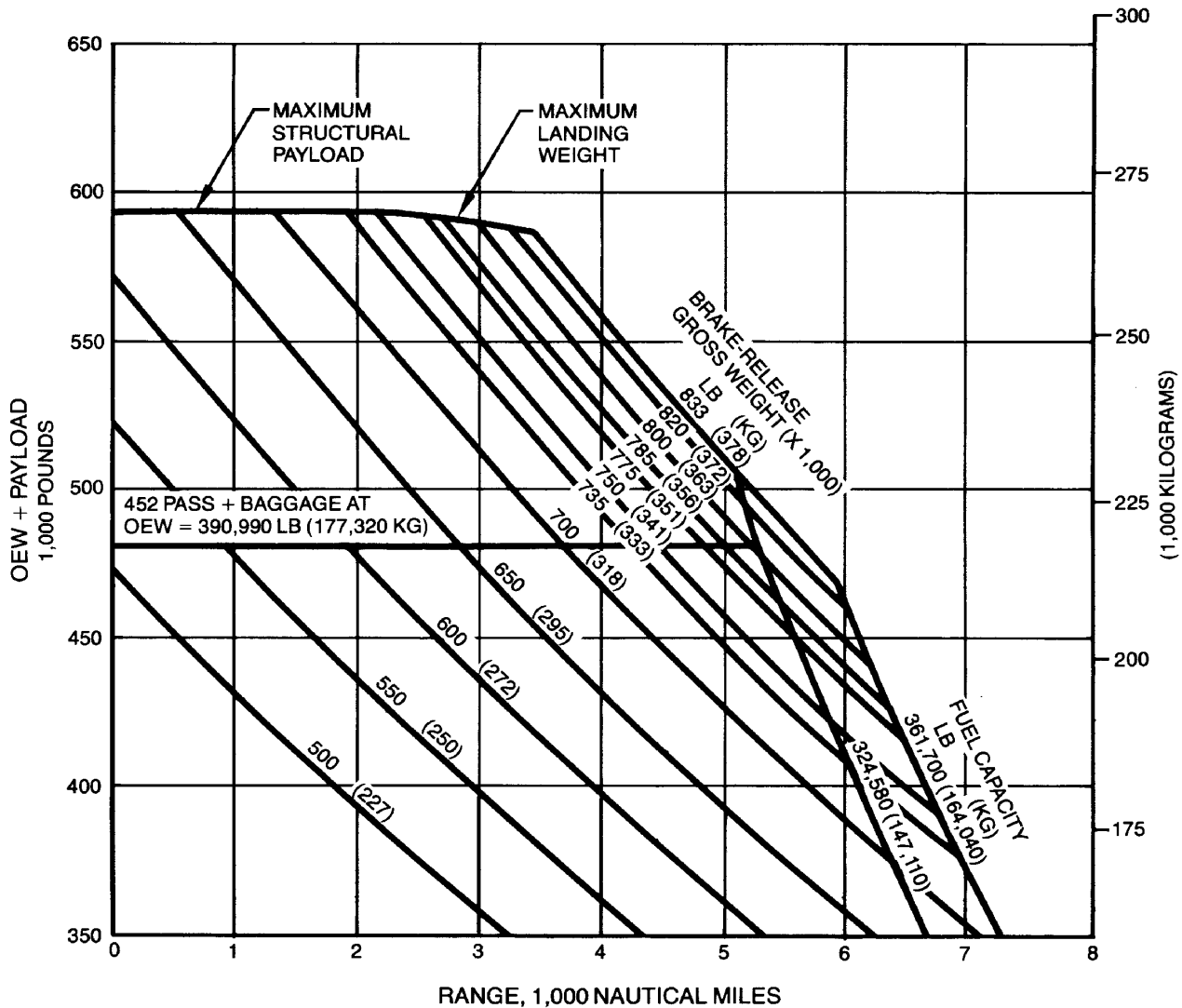

3.2.6 PAYLOAD/RANGE FOR LONG-RANGE CRUISE
MODELS 747-100B, -200 (RB211-524B2, C2 ENGINES)

- NOTES:
- STANDARD DAY, ZERO WIND
 - LRC AT 31-35-39,000 FT STEP CRUISE
 - TWO AIR-CONDITIONING PACKS ON DURING CRUISE
 - RESERVES PER F.A.R. 121.645(b) AND ATA (OCT. 1967) INT'L RULES
 - CONSULT USING AIRLINE FOR SPECIFIC OPERATING PROCEDURE AND OEW PRIOR TO FACILITY DESIGN

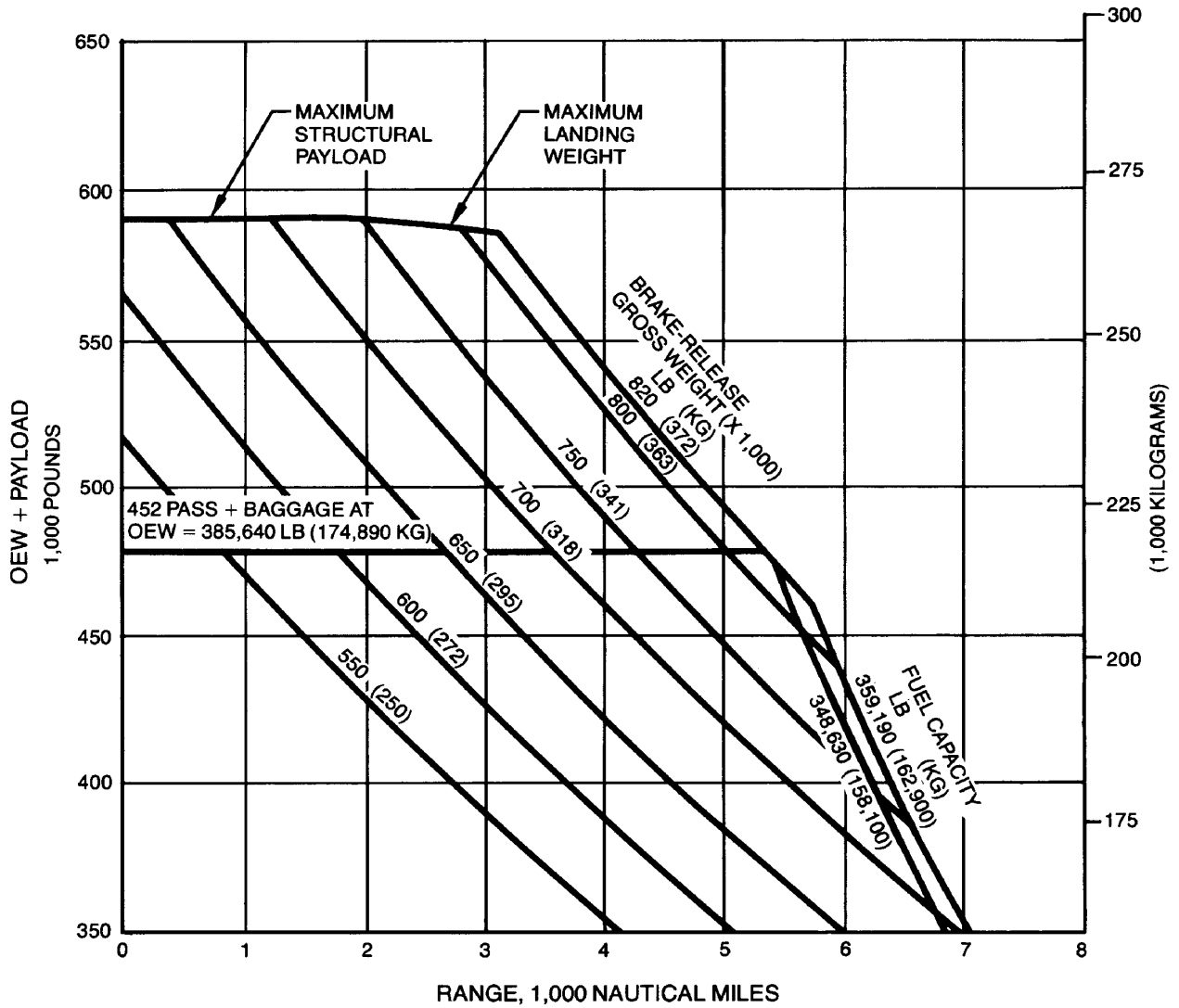

**3.2.7 PAYLOAD/RANGE FOR LONG-RANGE CRUISE
MODEL 747-200 (JT9D-70A ENGINES)**

D6-58326

MAY 1984

63

NOTES:

- STANDARD DAY, ZERO WIND
- LRC AT 31-35-39,000 FT STEP CRUISE
- TWO AIR-CONDITIONING PACKS ON DURING CRUISE
- RESERVES PER F.A.R. 121.645(b) AND ATA (OCT. 1967) INT'L RULES
- CONSULT USING AIRLINE FOR SPECIFIC OPERATING PROCEDURE AND OEW PRIOR TO FACILITY DESIGN

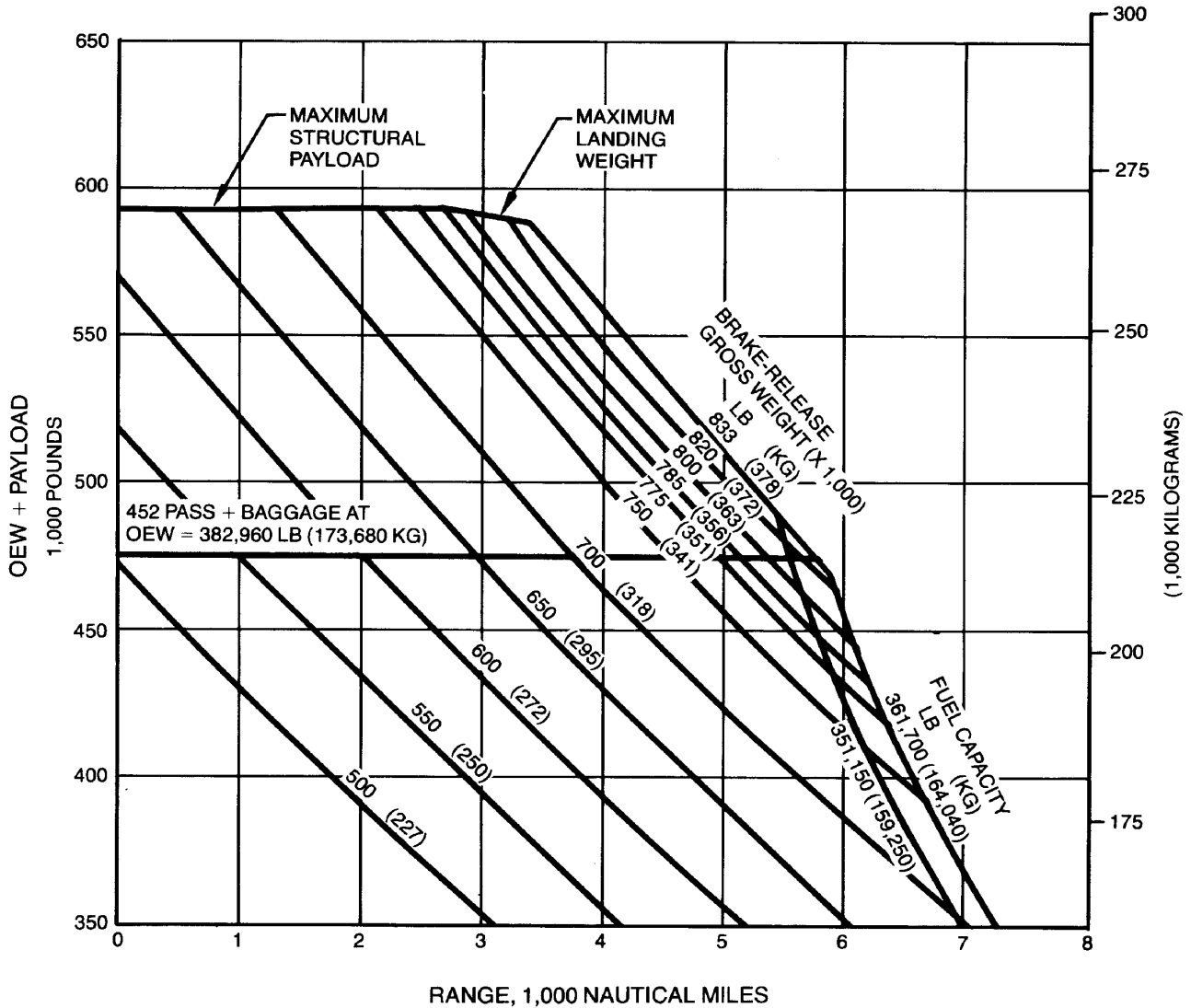

**3.2.8 PAYLOAD/RANGE FOR LONG-RANGE CRUISE
MODEL 747-200 (JT9D-7Q ENGINES)**

NOTES:

- STANDARD DAY, ZERO WIND
- LRC AT 31-35-39,000 FT STEP CRUISE
- TWO AIR-CONDITIONING PACKS ON DURING CRUISE
- RESERVES PER F.A.R. 121.645(b) AND ATA (OCT. 1967) INT'L RULES
- CONSULT USING AIRLINE FOR SPECIFIC OPERATING PROCEDURE AND OEW PRIOR TO FACILITY DESIGN
- FOR 747-300, REDUCE RANGE BY 1.5%

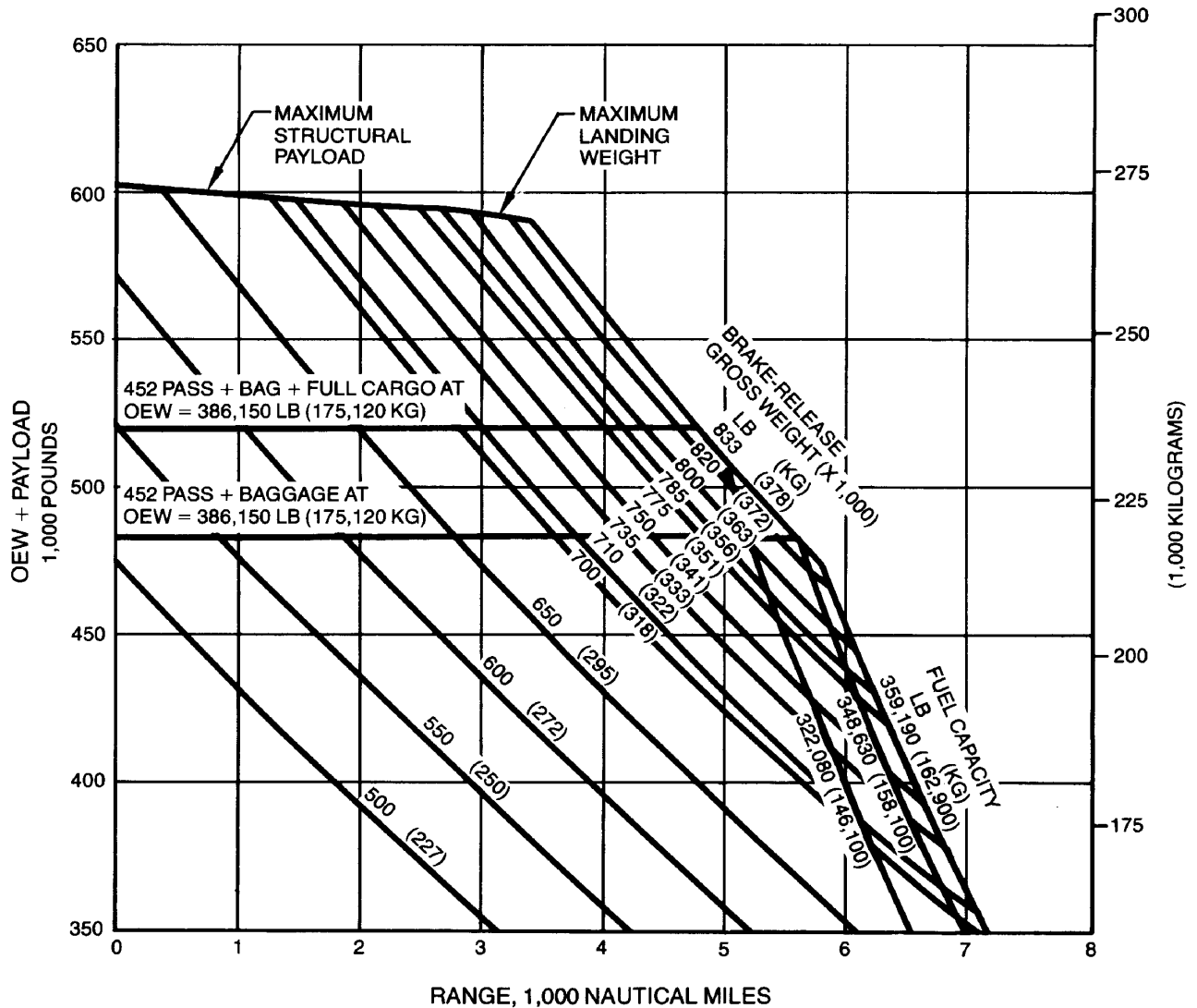

**3.2.9 PAYLOAD/RANGE FOR LONG-RANGE CRUISE
MODELS 747-200, -300 (CF6-50E2 ENGINES)**

D6-58326

MAY 1984

65

NOTES:

- STANDARD DAY, ZERO WIND
- LRC AT 31-35-39,000 FT STEP CRUISE
- TWO AIR-CONDITIONING PACKS ON DURING CRUISE
- RESERVES PER F.A.R. 121.645(b) AND ATA (OCT. 1967) INT'L RULES
- CONSULT USING AIRLINE FOR SPECIFIC OPERATING PROCEDURE AND OEW PRIOR TO FACILITY DESIGN
- FOR 747-300, REDUCE RANGE BY 1.5%

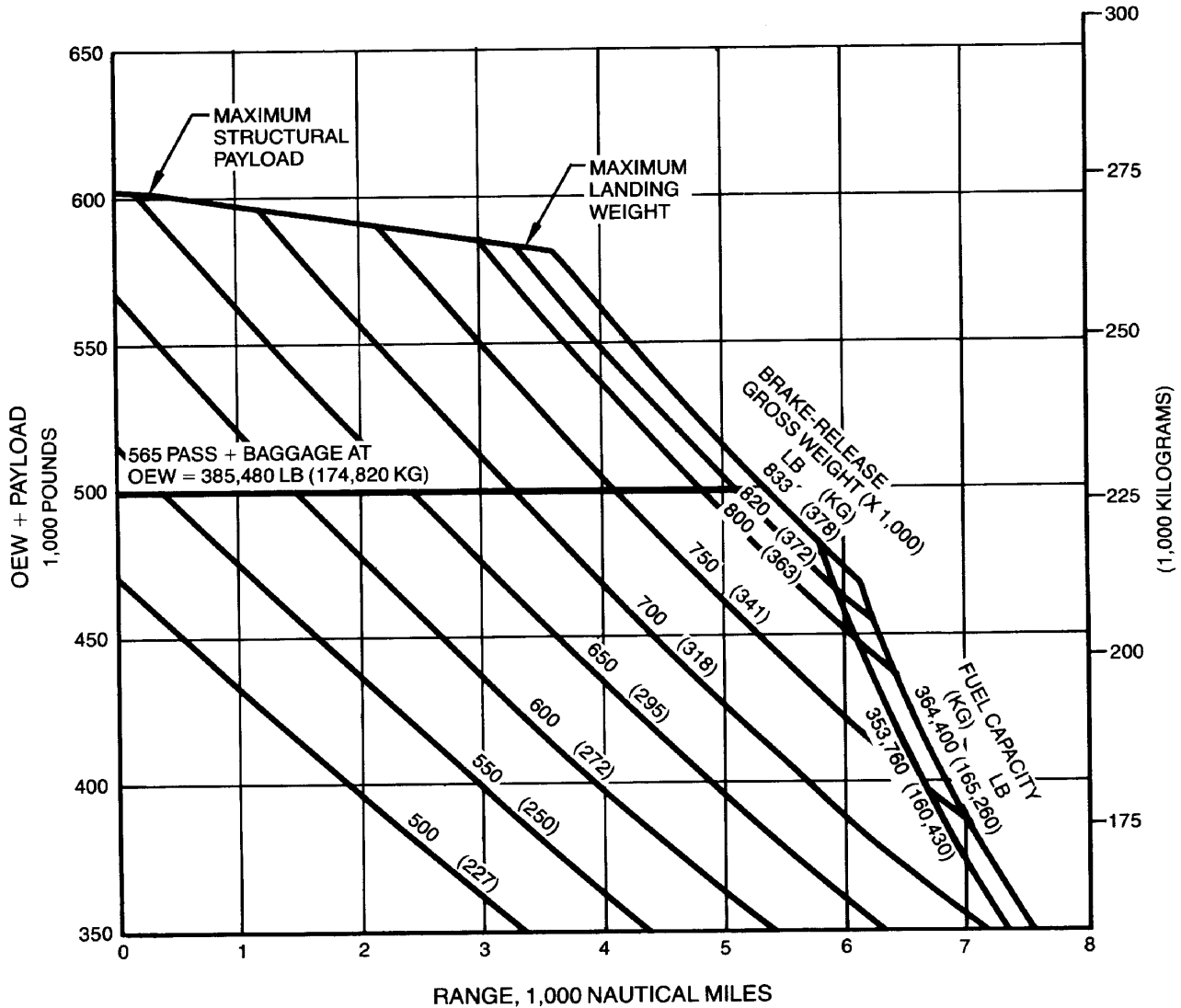

**3.2.10 PAYLOAD/RANGE FOR LONG-RANGE CRUISE
MODELS 747-200, -300 (JT9D-7R4G2 ENGINES)**

NOTES:

- STANDARD DAY, ZERO WIND
- LRC AT 31-35-39,000 FT STEP CRUISE
- TWO AIR-CONDITIONING PACKS ON DURING CRUISE
- RESERVES PER F.A.R. 121.645(b) AND ATA (OCT. 1967) INT'L RULES
- CONSULT USING AIRLINE FOR SPECIFIC OPERATING PROCEDURE AND OEW PRIOR TO FACILITY DESIGN
- FOR 747-300, REDUCE RANGE BY 1.5%

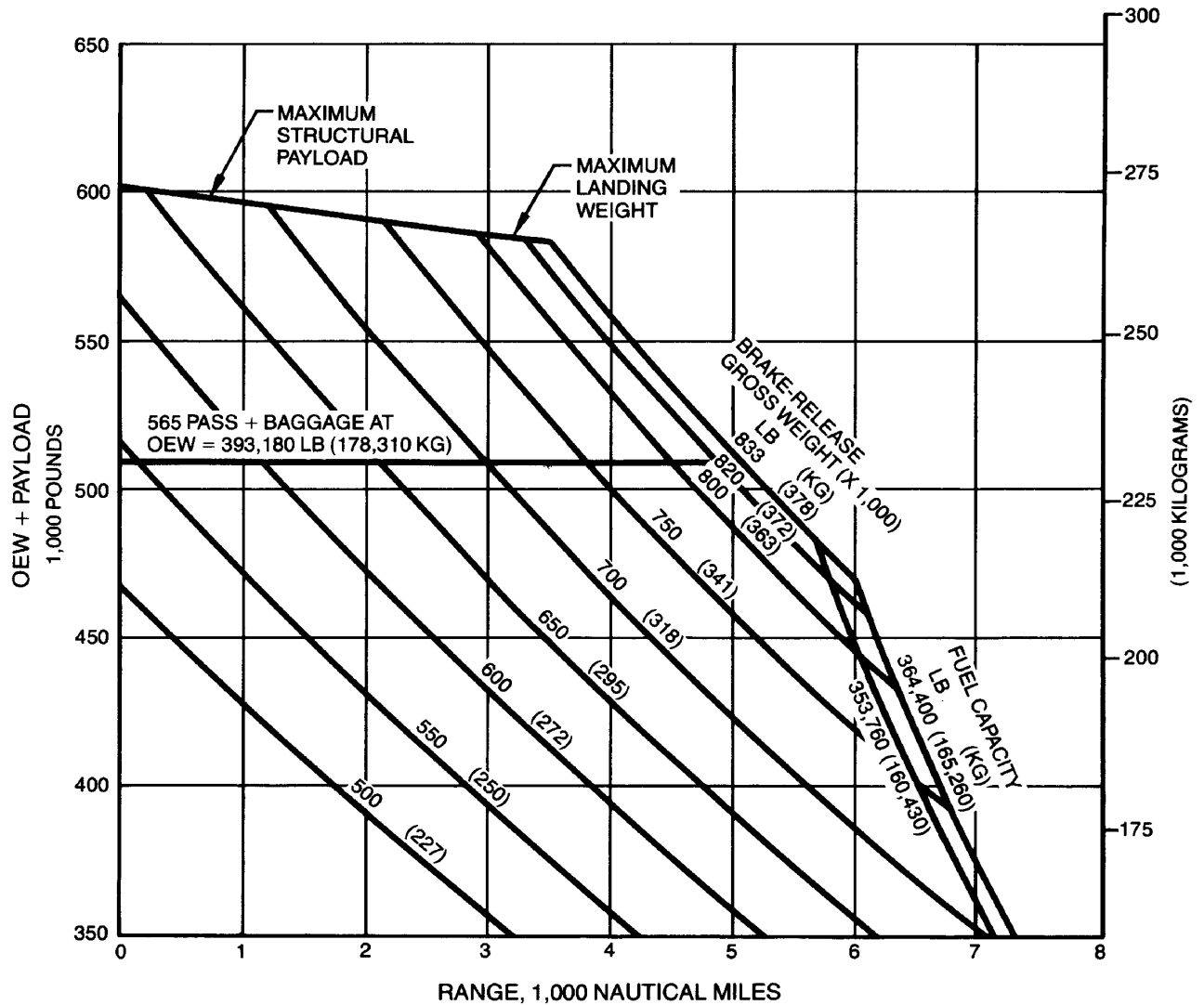

3.2.11 PAYLOAD/RANGE FOR LONG-RANGE CRUISE
MODELS 747-200, -300 (RB211-524D4 ENGINES)

D6-58326

MAY 1984

67

NOTES:

- STANDARD DAY, ZERO WIND
- LRC AT 31-35-39,000 FT STEP CRUISE
- TWO AIR-CONDITIONING PACKS ON DURING CRUISE
- RESERVES PER F.A.R. 121.645(b) AND ATA (OCT. 1967) INT'L RULES
- CONSULT USING AIRLINE FOR SPECIFIC OPERATING PROCEDURE AND OEW PRIOR TO FACILITY DESIGN

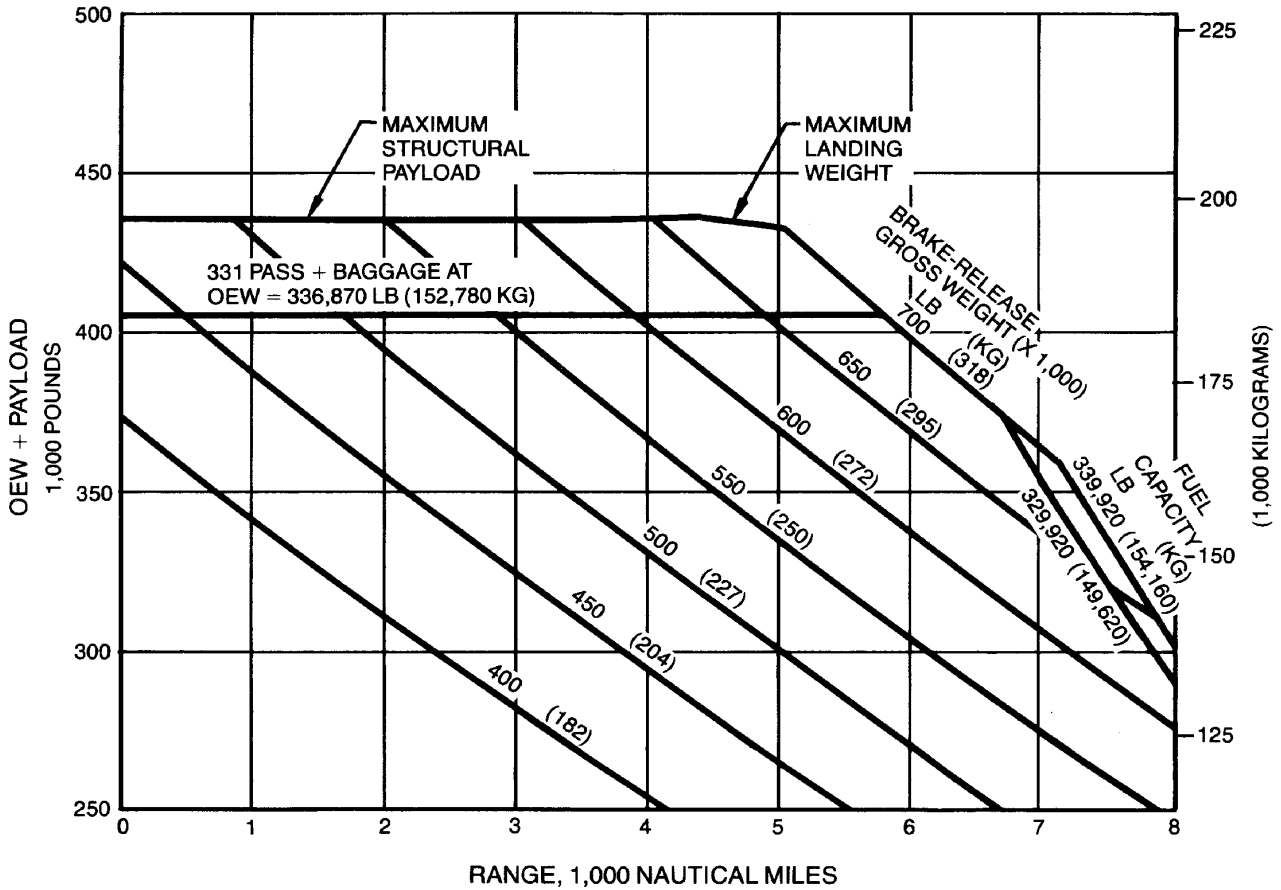

**3.2.12 PAYLOAD/RANGE FOR LONG-RANGE CRUISE
MODEL 747SP (RB211-524B2, C2, D4 ENGINES)**

- NOTES:
- STANDARD DAY, ZERO WIND
 - LRC AT 31-35-39,000 FT STEP CRUISE
 - TWO AIR-CONDITIONING PACKS ON DURING CRUISE
 - RESERVES PER F.A.R. 121.645(b) AND ATA (OCT. 1967) INT'L RULES
 - MAXIMUM ENGINE INJECTION WATER IS 5,000 LB (2,268 KG)
 - CONSULT USING AIRLINE FOR SPECIFIC OPERATING PROCEDURE AND OEW PRIOR TO FACILITY DESIGN

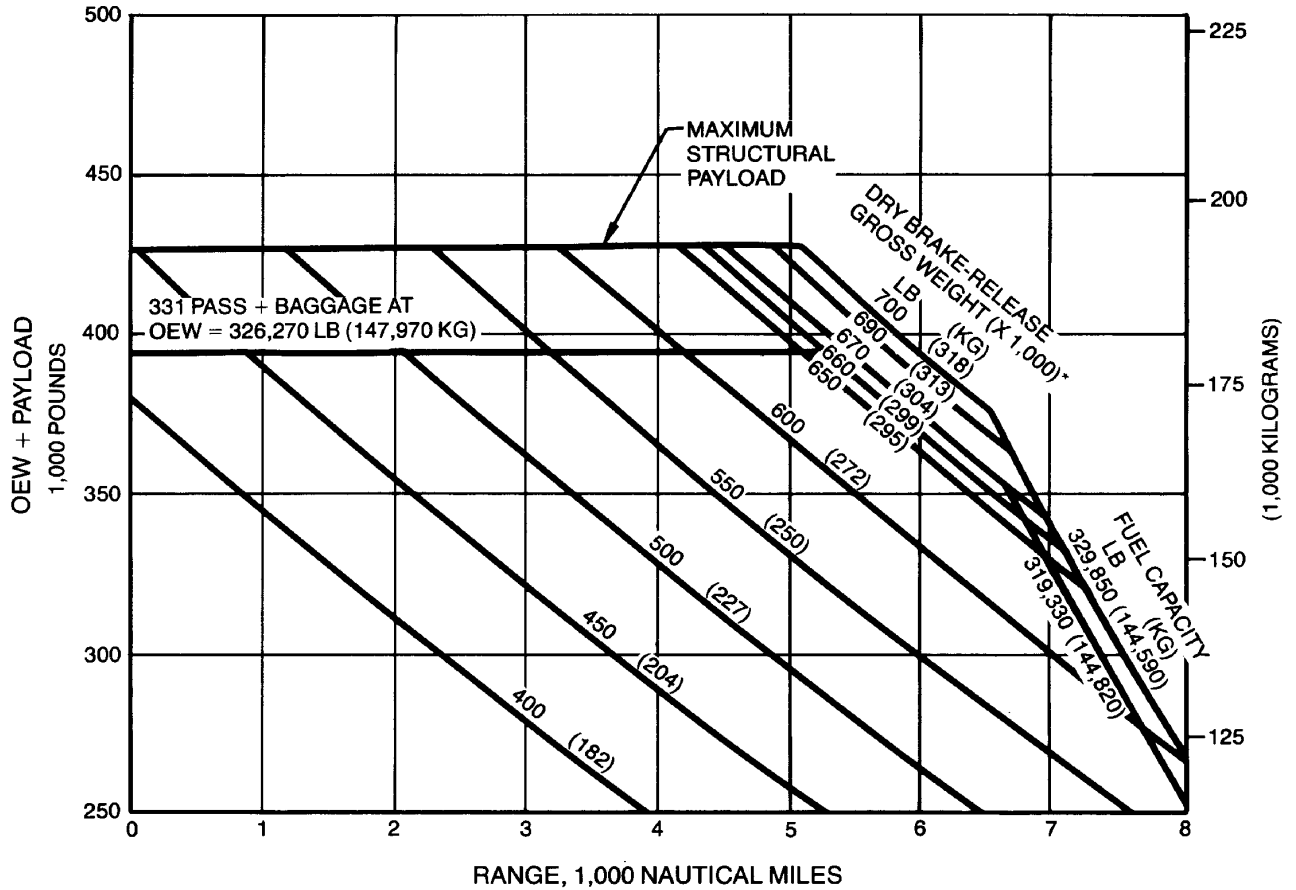

*FOR JT9D-7AW ENGINES, SUBTRACT WATER WEIGHT FROM WET BRAKE-RELEASE WEIGHT AND ENTER CURVE WITH DRY BRAKE-RELEASE WEIGHT.

3.2.13 PAYLOAD/RANGE FOR LONG-RANGE CRUISE MODEL 747SP (JT9D-7A, -7AW, ENGINES)

D6-58326

APRIL 1981

69

NOTES:

- STANDARD DAY, ZERO WIND
- LRC AT 31-35-39,000 FT STEP CRUISE
- TWO AIR-CONDITIONING PACKS ON DURING CRUISE
- RESERVES PER F.A.R. 121.645(b) AND ATA (OCT. 1967) INT'L RULES
- MAXIMUM ENGINE INJECTION WATER IS 5,000 LB (2,268 KG)
- CONSULT USING AIRLINE FOR SPECIFIC OPERATING PROCEDURE AND OEW PRIOR TO FACILITY DESIGN

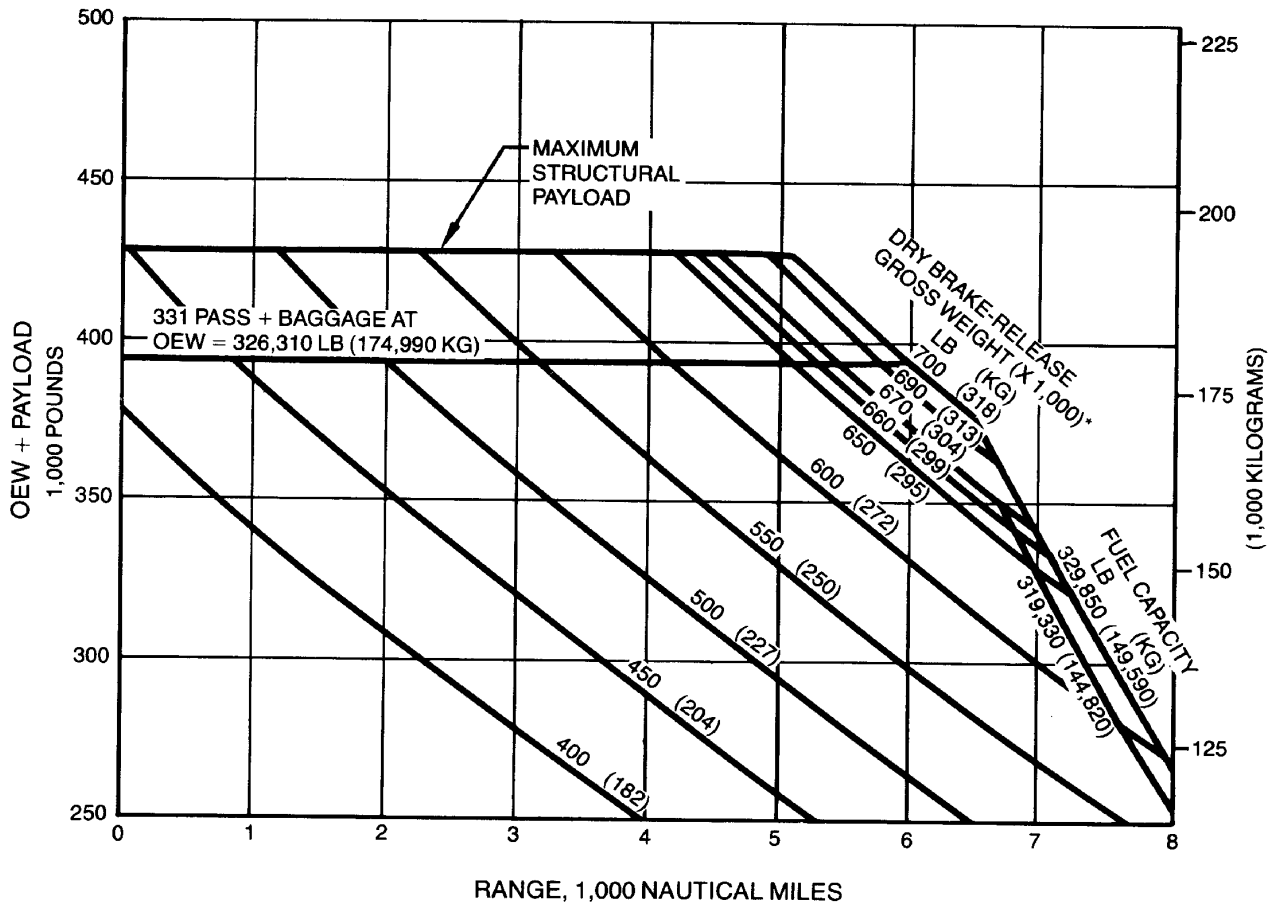

*FOR JT9D-7FW ENGINES, SUBTRACT WATER WEIGHT FROM WET BRAKE-RELEASE WEIGHT AND ENTER CURVE WITH DRY BRAKE-RELEASE WEIGHT

**3.2.14 PAYLOAD/RANGE FOR LONG-RANGE CRUISE
MODEL 747SP (JT9D-7F, -7FW, -7J ENGINES)**

THIS PAGE INTENTIONALLY LEFT BLANK

D6-58326

Not Subject to EAR or ITAR.
Copyright © 2023 Boeing. All Rights Reserved.

- NOTES:
- CONSULT USING AIRLINE FOR SPECIFIC OPERATING PROCEDURE PRIOR TO FACILITY DESIGN.
 - AIR CONDITIONING OFF. ONE A/C PACK MAY BE OPERATED BY THE APU WITH NO THRUST PENALTY.
 - ZERO RUNWAY GRADIENT

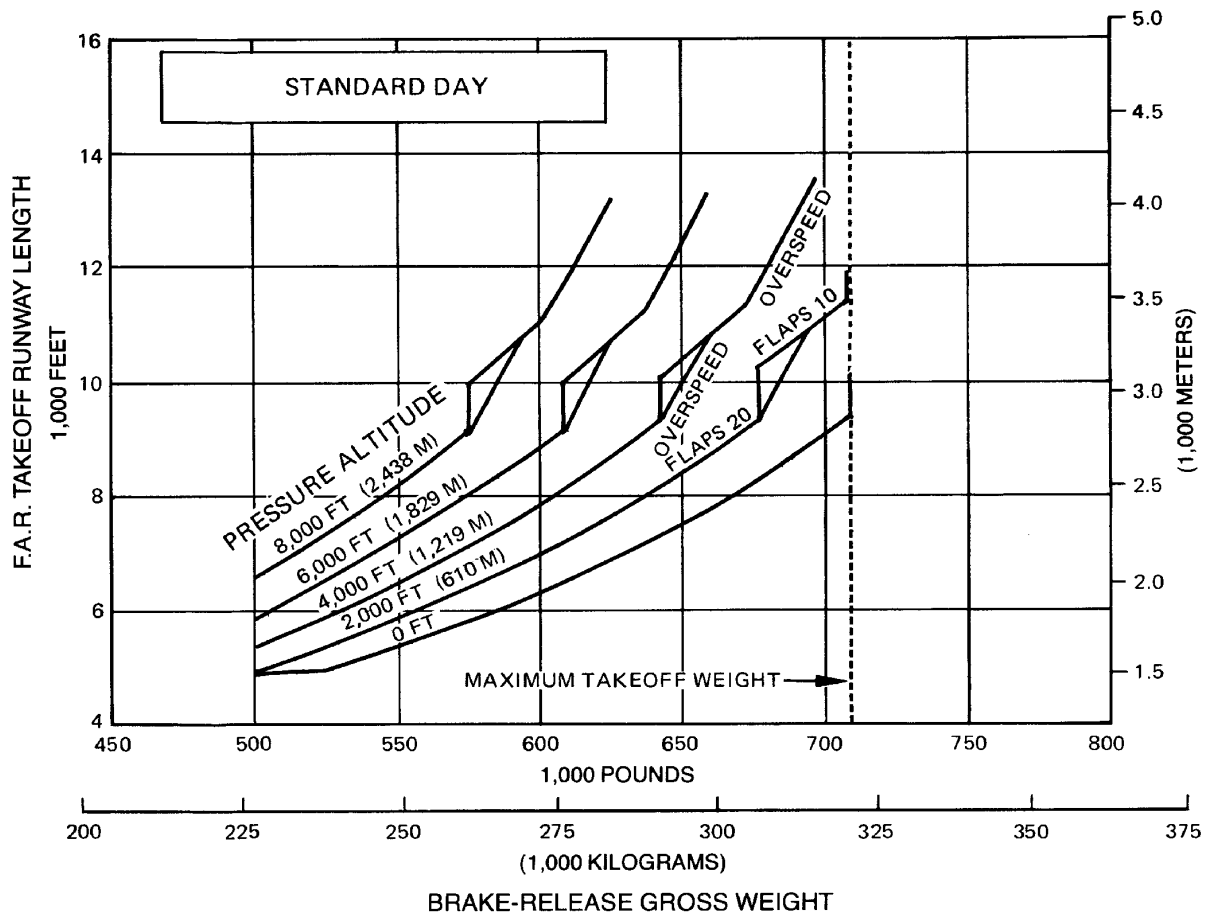

**3.3.1 F.A.R. TAKEOFF RUNWAY-LENGTH REQUIREMENTS
STANDARD DAY
MODEL 747-100 (JT9D-3A ENGINES)**

- NOTES:
- CONSULT USING AIRLINE FOR SPECIFIC OPERATING PROCEDURE PRIOR TO FACILITY DESIGN.
 - AIR CONDITIONING OFF ONE A/C PACK MAY BE OPERATED BY THE APU WITH NO THRUST PENALTY.
 - ZERO RUNWAY GRADIENT

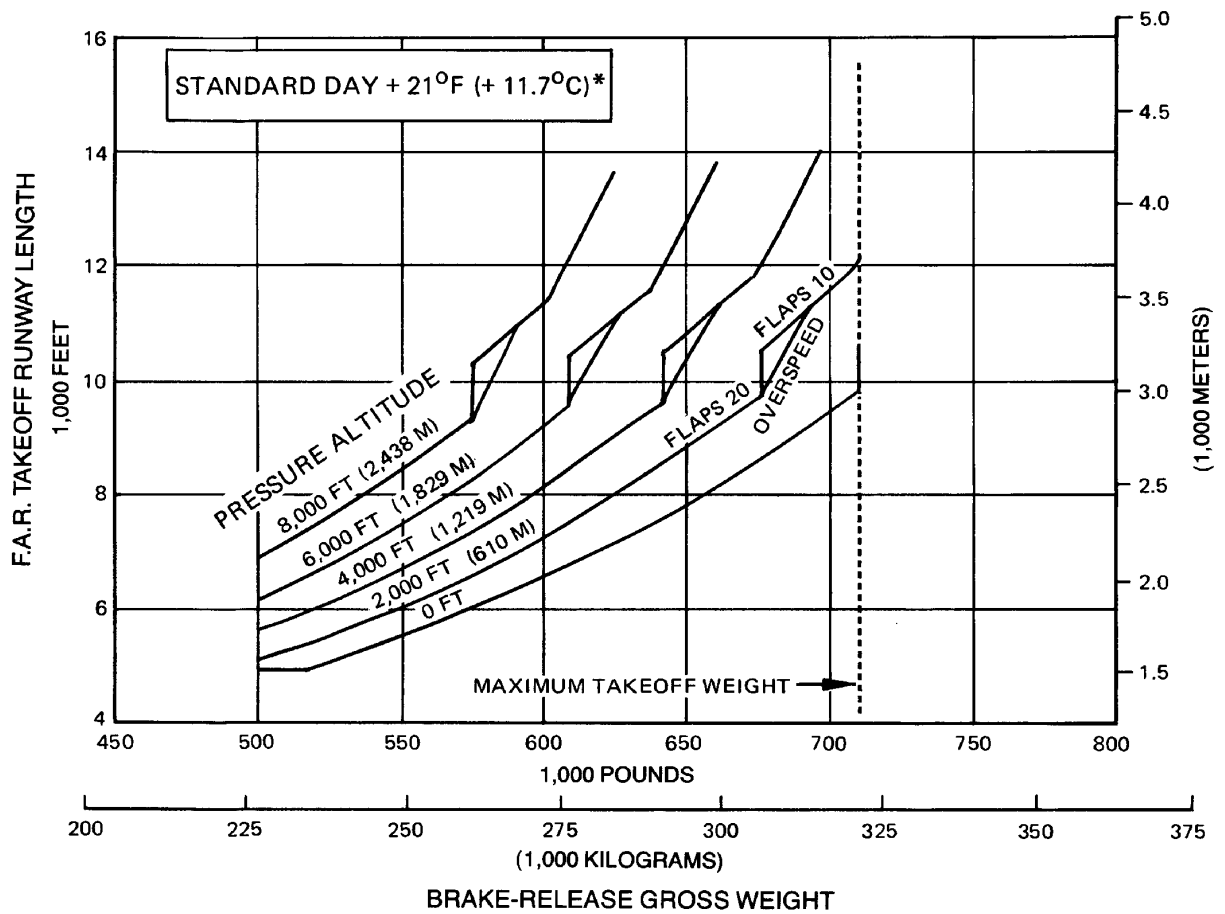

*THE JT9D-3A ENGINE IS FLAT RATED TO STD + 21°F (+ 11.7°C).

3.3.2 F.A.R. TAKEOFF RUNWAY-LENGTH REQUIREMENTS
STANDARD DAY +21°F (+11.7°C)*
MODEL 747-100 (JT9D-3A ENGINES)

- NOTES:
- CONSULT USING AIRLINE FOR SPECIFIC OPERATING PROCEDURE PRIOR TO FACILITY DESIGN.
 - AIR CONDITIONING OFF ONE A/C PACK MAY BE OPERATED BY THE APU WITH NO THRUST PENALTY.
 - ZERO RUNWAY GRADIENT

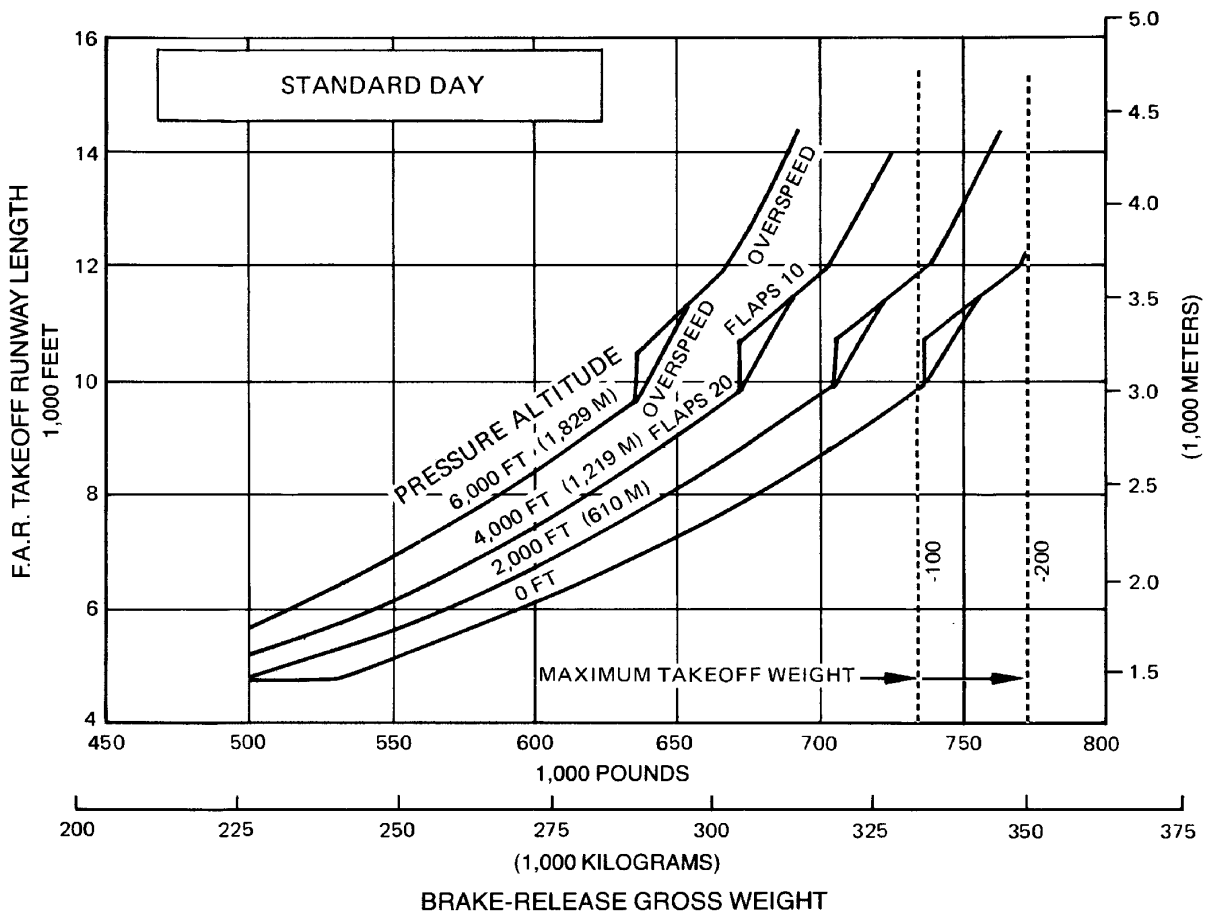

**3.3.3 F.A.R. TAKEOFF RUNWAY-LENGTH REQUIREMENTS
STANDARD DAY
MODELS 747-100, -200 (JT9D-3AW ENGINES)**

- NOTES:
- CONSULT USING AIRLINE FOR SPECIFIC OPERATING PROCEDURE PRIOR TO FACILITY DESIGN.
 - AIR CONDITIONING OFF. ONE A/C PACK MAY BE OPERATED BY THE APU WITH NO THRUST PENALTY.
 - ZERO RUNWAY GRADIENT

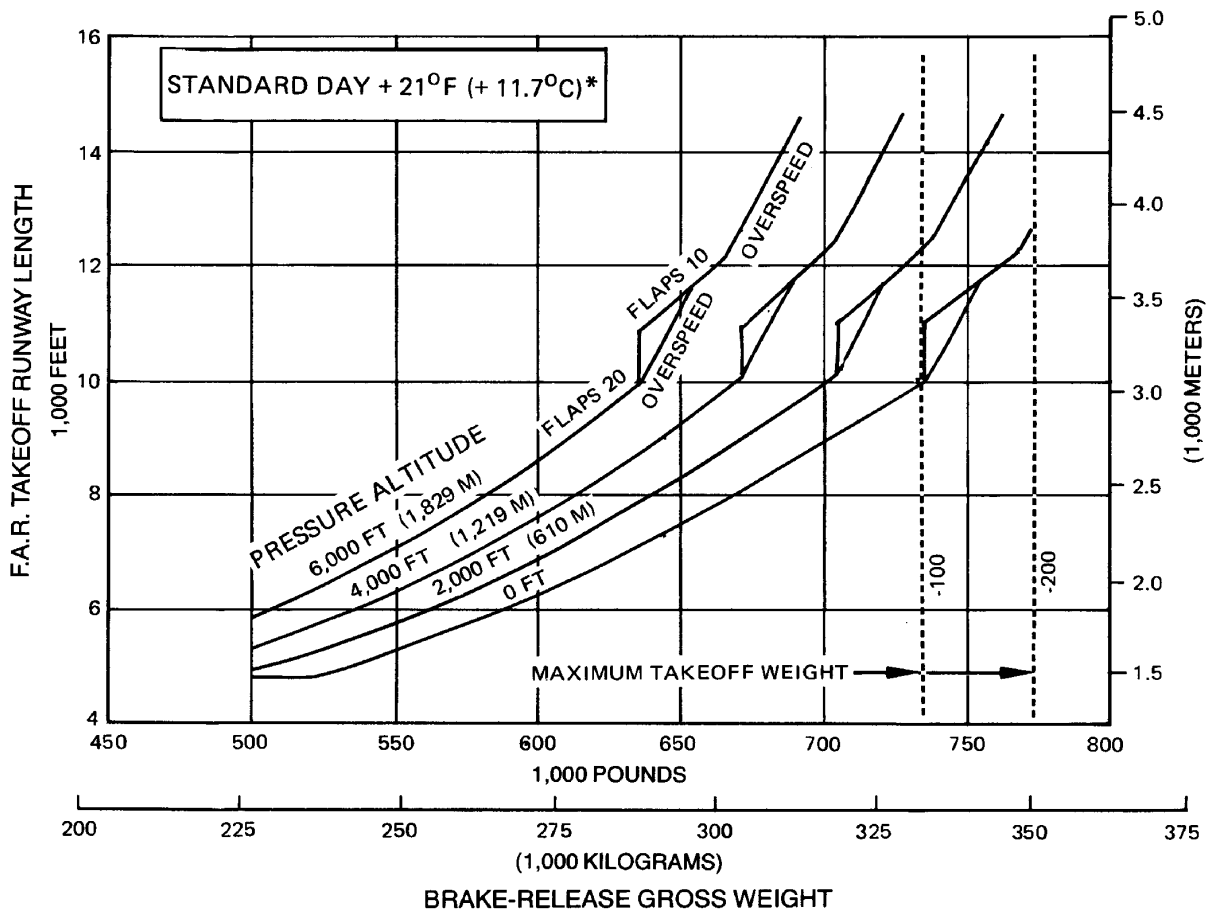

*THE JT9D-3AW ENGINE IS FLAT RATED TO STD + 21°F (+ 11.7°C).

3.3.4 F.A.R. TAKEOFF RUNWAY-LENGTH REQUIREMENTS
STANDARD DAY +21°F (+11.7°C)*
MODELS 747-100, -200 (JT9D-3AW ENGINES)

D6-58326

APRIL 1981

75

- NOTES:
- CONSULT USING AIRLINE FOR SPECIFIC OPERATING PROCEDURE PRIOR TO FACILITY DESIGN.
 - AIR CONDITIONING OFF. ONE A/C PACK MAY BE OPERATED BY THE APU WITH NO THRUST PENALTY.
 - ZERO RUNWAY GRADIENT

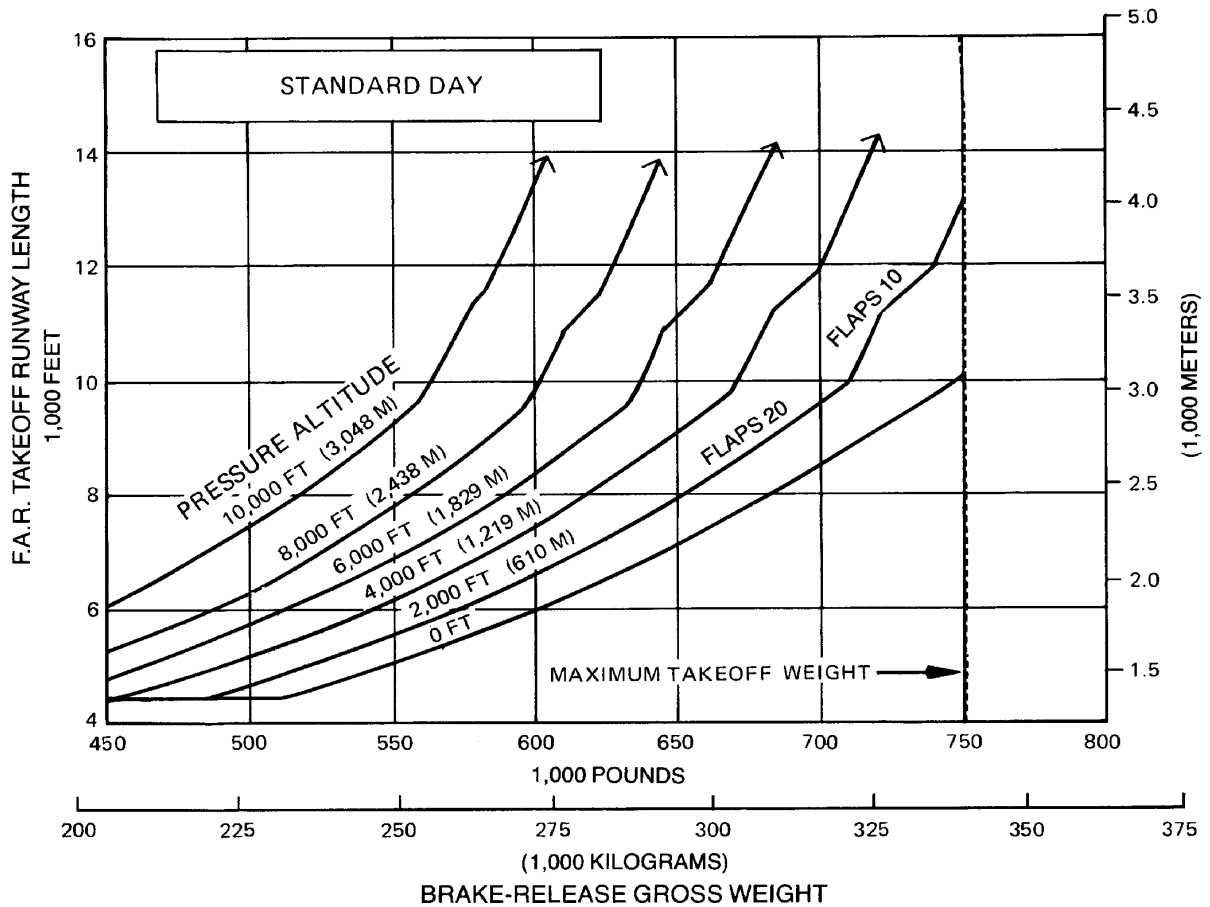

**3.3.5 F.A.R. TAKEOFF RUNWAY-LENGTH REQUIREMENTS
STANDARD DAY
MODEL 747-100B (JT9D-7A ENGINES)**

- NOTES:
- CONSULT USING AIRLINE FOR SPECIFIC OPERATING PROCEDURE PRIOR TO FACILITY DESIGN.
 - AIR CONDITIONING OFF. ONE A/C PACK MAY BE OPERATED BY THE APU WITH NO THRUST PENALTY.
 - ZERO RUNWAY GRADIENT

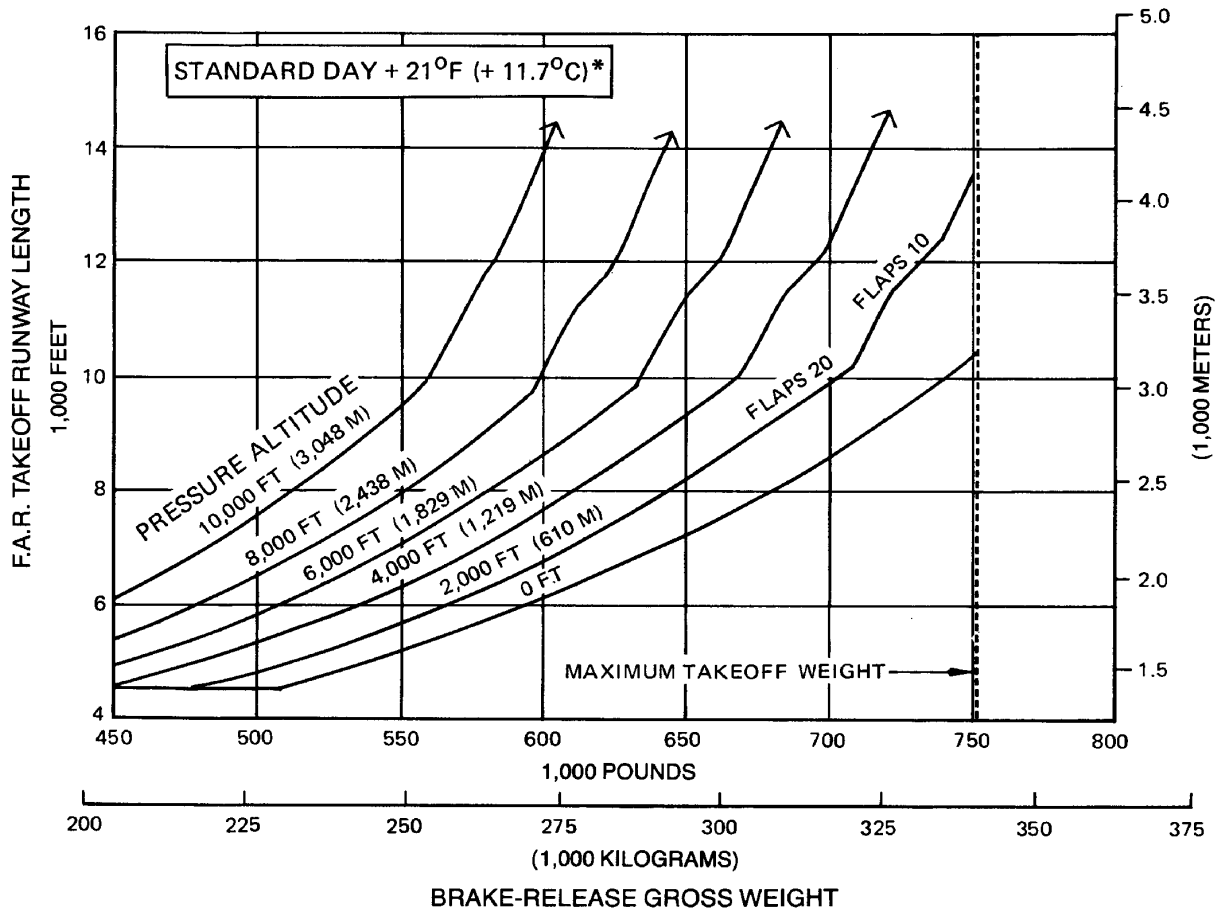

* THE JT9D-7A ENGINE IS FLAT RATED TO STD + 21°F (+11.7°C).

3.3.6 F.A.R TAKEOFF RUNWAY-LENGTH REQUIREMENTS
STANDARD DAY +21°F (+11.7°C)*
MODEL 747-100B (JT9D-7A ENGINES)

D6-58326

APRIL 1981

77

- NOTES:
- CONSULT USING AIRLINE FOR SPECIFIC OPERATING PROCEDURE PRIOR TO FACILITY DESIGN.
 - AIR CONDITIONING OFF. ONE A/C PACK MAY BE OPERATED BY THE APU WITH NO THRUST PENALTY.
 - ZERO RUNWAY GRADIENT

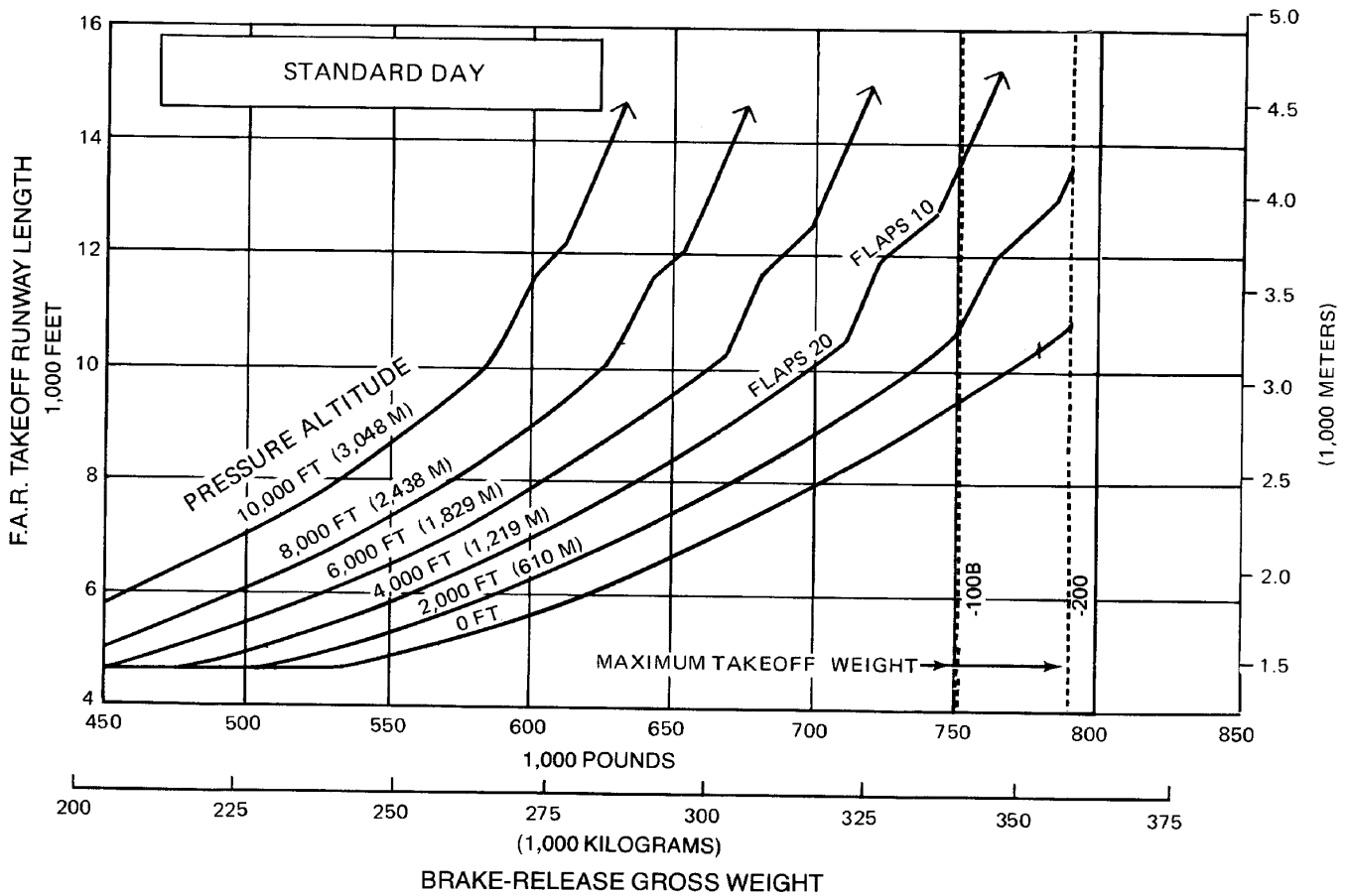

**3.3.7 F.A.R TAKEOFF RUNWAY-LENGTH REQUIREMENTS
STANDARD DAY
MODELS 747-100B, -200 (JT9D-7AW ENGINES)**

- NOTES:
- CONSULT USING AIRLINE FOR SPECIFIC OPERATING PROCEDURE PRIOR TO FACILITY DESIGN.
 - AIR CONDITIONING OFF. ONE A/C PACK MAY BE OPERATED BY THE APU WITH NO THRUST PENALTY.
 - ZERO RUNWAY GRADIENT

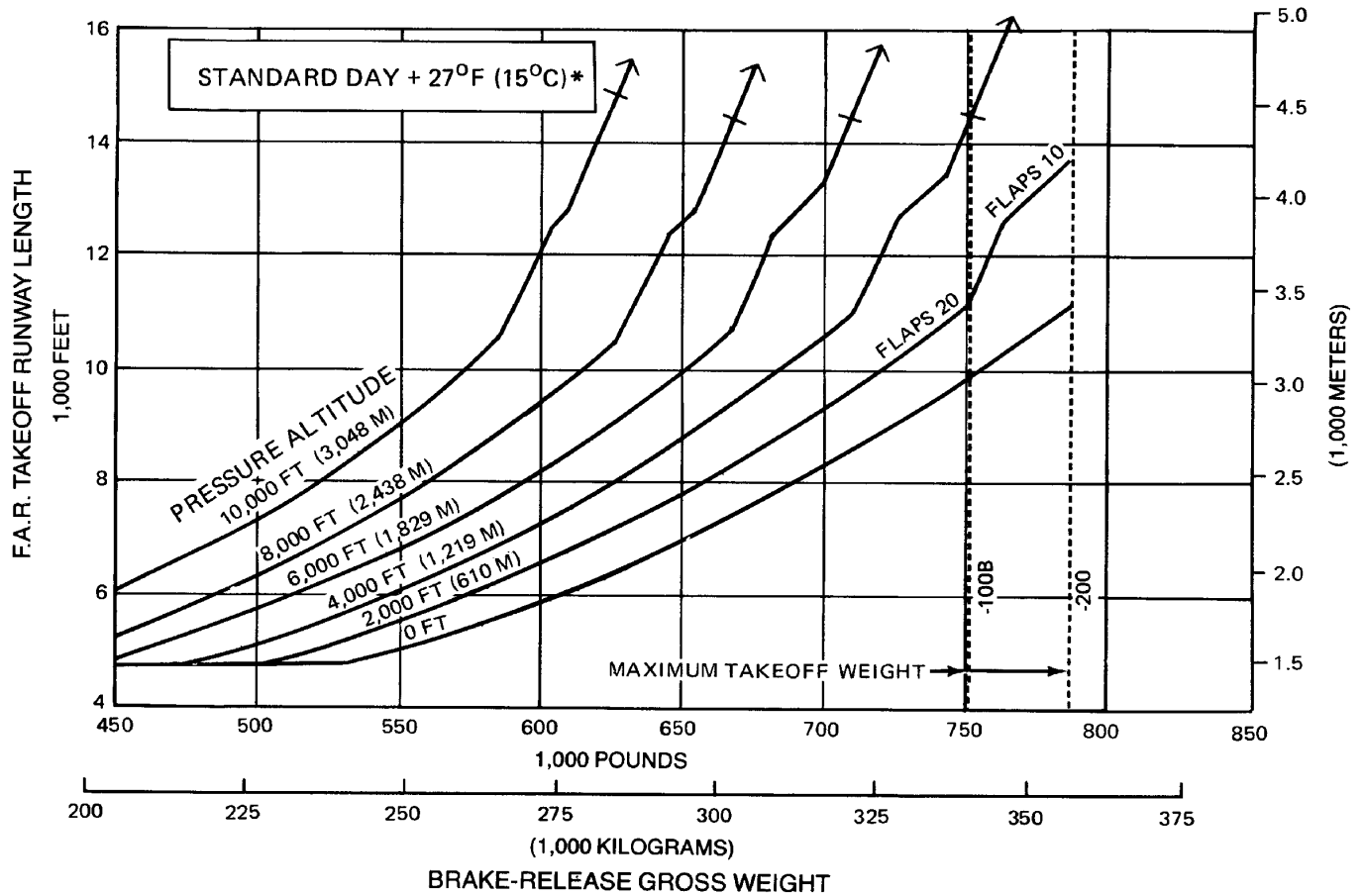

*THE JT9D-7AW ENGINE IS FLAT RATED TO STD + 27°F (+ 15°C).

3.3.8 F.A.R TAKEOFF RUNWAY-LENGTH REQUIREMENTS
STANDARD DAY +27°F (+15°C)*
MODELS 747-100B, -200 (JT9D-7AW ENGINES)

- NOTES:
- CONSULT USING AIRLINE FOR SPECIFIC OPERATING PROCEDURE PRIOR TO FACILITY DESIGN.
 - AIR CONDITIONING OFF. ONE A/C PACK MAY BE OPERATED BY THE APU WITH NO THRUST PENALTY.
 - ZERO RUNWAY GRADIENT

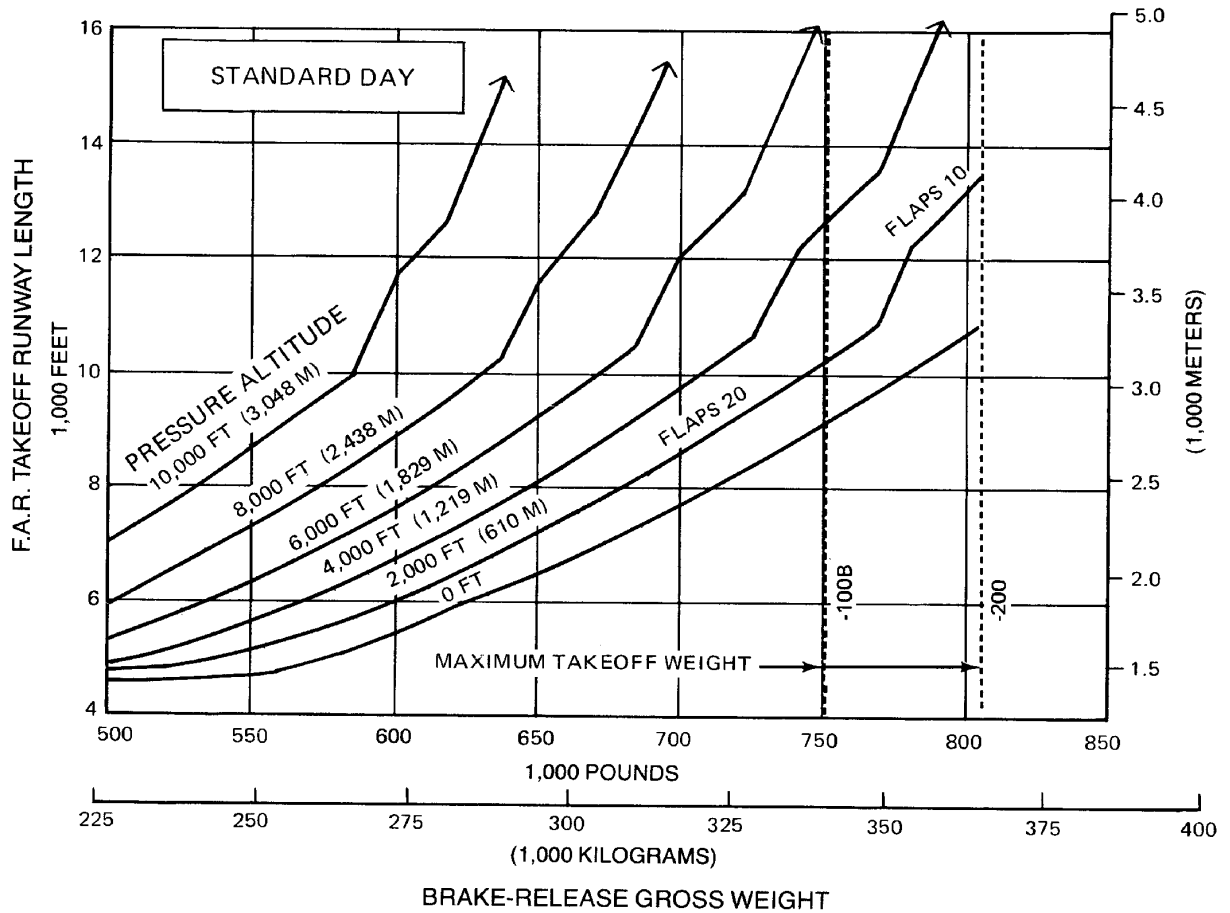

**3.3.9 F.A.R TAKEOFF RUNWAY-LENGTH REQUIREMENTS
STANDARD DAY
MODELS 747-100B, -200 (JT9D-7FW ENGINES)**

- NOTES:
- CONSULT USING AIRLINE FOR SPECIFIC OPERATING PROCEDURE PRIOR TO FACILITY DESIGN.
 - AIR CONDITIONING OFF. ONE A/C PACK MAY BE OPERATED BY THE APU WITH NO THRUST PENALTY.
 - ZERO RUNWAY GRADIENT

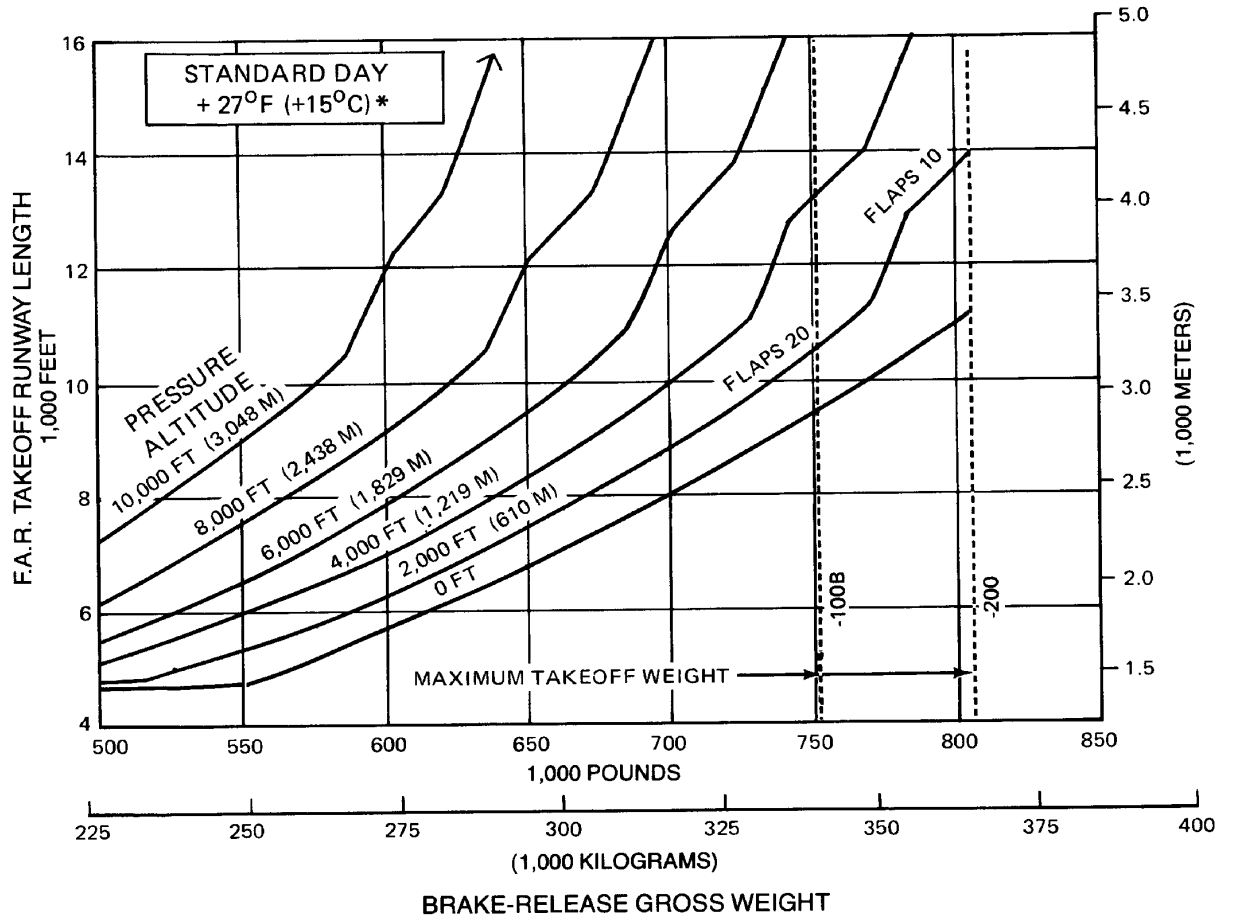

*THE JT9D-7FW ENGINE IS FLAT RATED TO STD + 27°F (+ 15°C).

3.3.10 F.A.R TAKEOFF RUNWAY-LENGTH REQUIREMENTS STANDARD DAY +27°F (+15°C)* MODELS 747-100B, -200 (JT9D-7FW ENGINES)

- NOTES:
- CONSULT USING AIRLINE FOR SPECIFIC OPERATING PROCEDURE PRIOR TO FACILITY DESIGN.
 - AIR CONDITIONING OFF. ONE A/C PACK MAY BE OPERATED BY THE APU WITH NO THRUST PENALTY.
 - ZERO RUNWAY GRADIENT

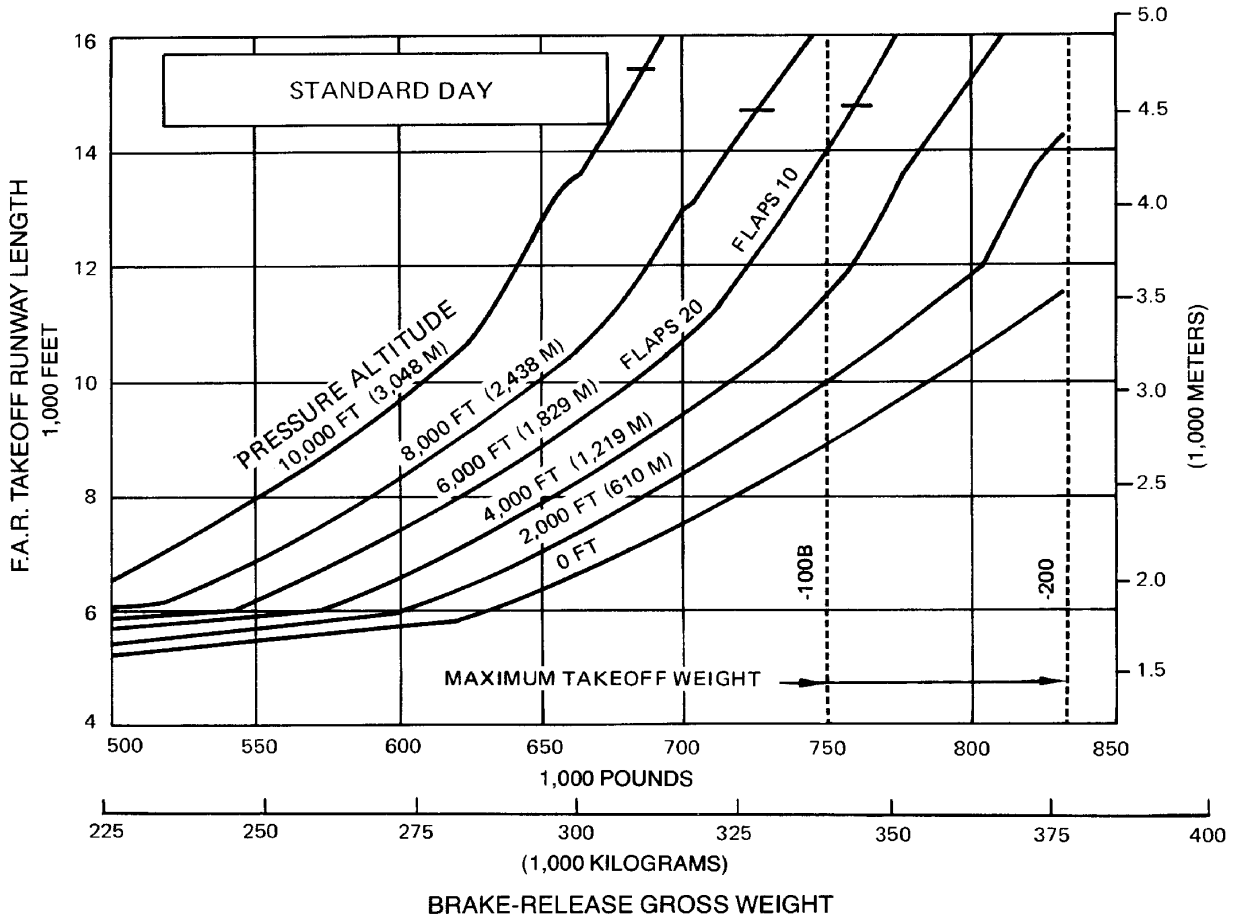

**3.3.11 F.A.R TAKEOFF RUNWAY-LENGTH REQUIREMENTS
STANDARD DAY
MODELS 747-100B, -200 (RB211-524B2 ENGINES)**

- NOTES:
- CONSULT USING AIRLINE FOR SPECIFIC OPERATING PROCEDURE PRIOR TO FACILITY DESIGN.
 - AIR CONDITIONING OFF. ONE A/C PACK MAY BE OPERATED BY THE APU WITH NO THRUST PENALTY.
 - ZERO RUNWAY GRADIENT

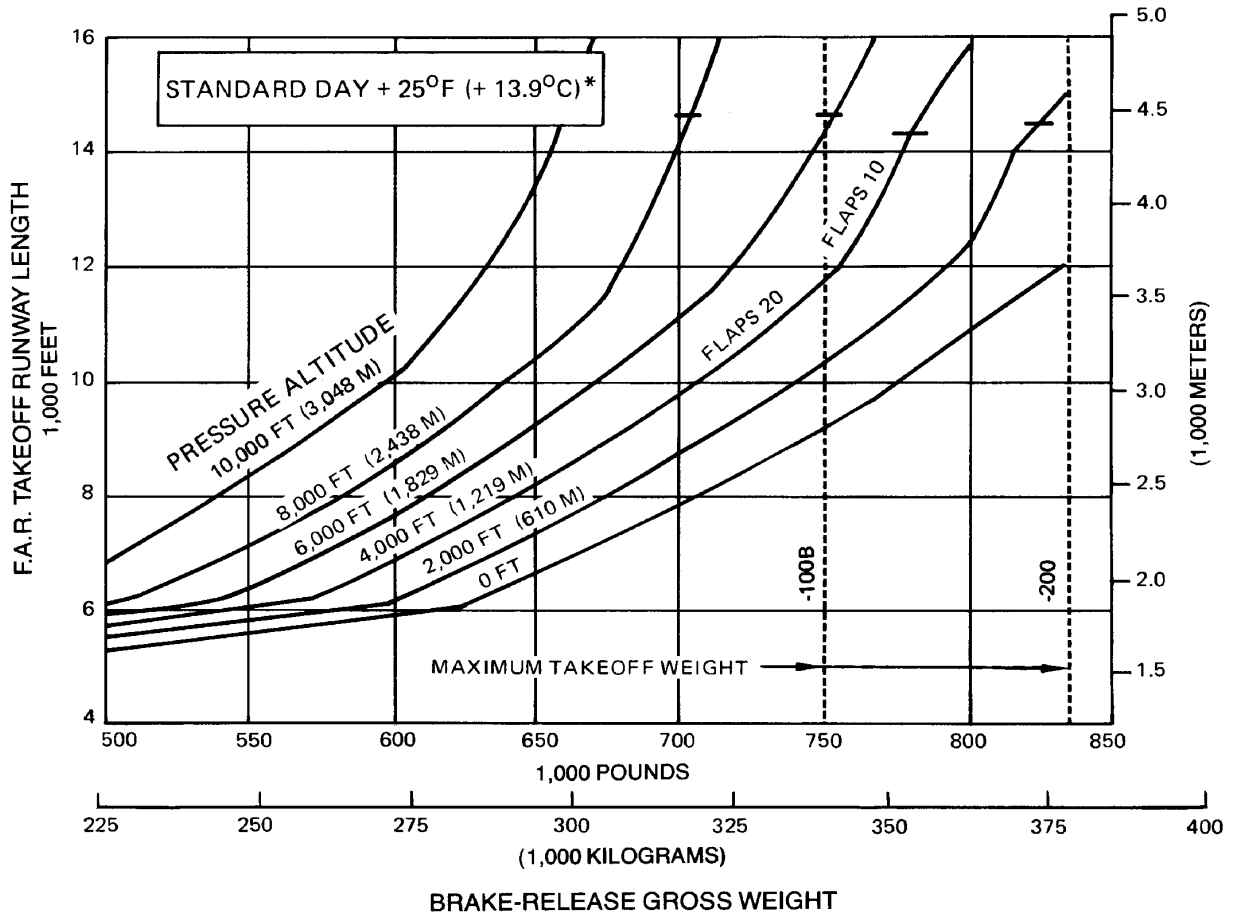

*THE RB211-524B2 ENGINE IS FLAT RATED TO STD + 25°F (+ 13.9°C).

3.3.12 F.A.R TAKEOFF RUNWAY-LENGTH REQUIREMENTS
STANDARD DAY +25°F (+13.9°C)*
MODELS 747-100B, -200 (RB211-524B2 ENGINES)

- NOTES:
- CONSULT USING AIRLINE FOR SPECIFIC OPERATING PROCEDURE PRIOR TO FACILITY DESIGN.
 - AIR CONDITIONING OFF. ONE A/C PACK MAY BE OPERATED BY THE APU WITH NO THRUST PENALTY.
 - ZERO RUNWAY GRADIENT

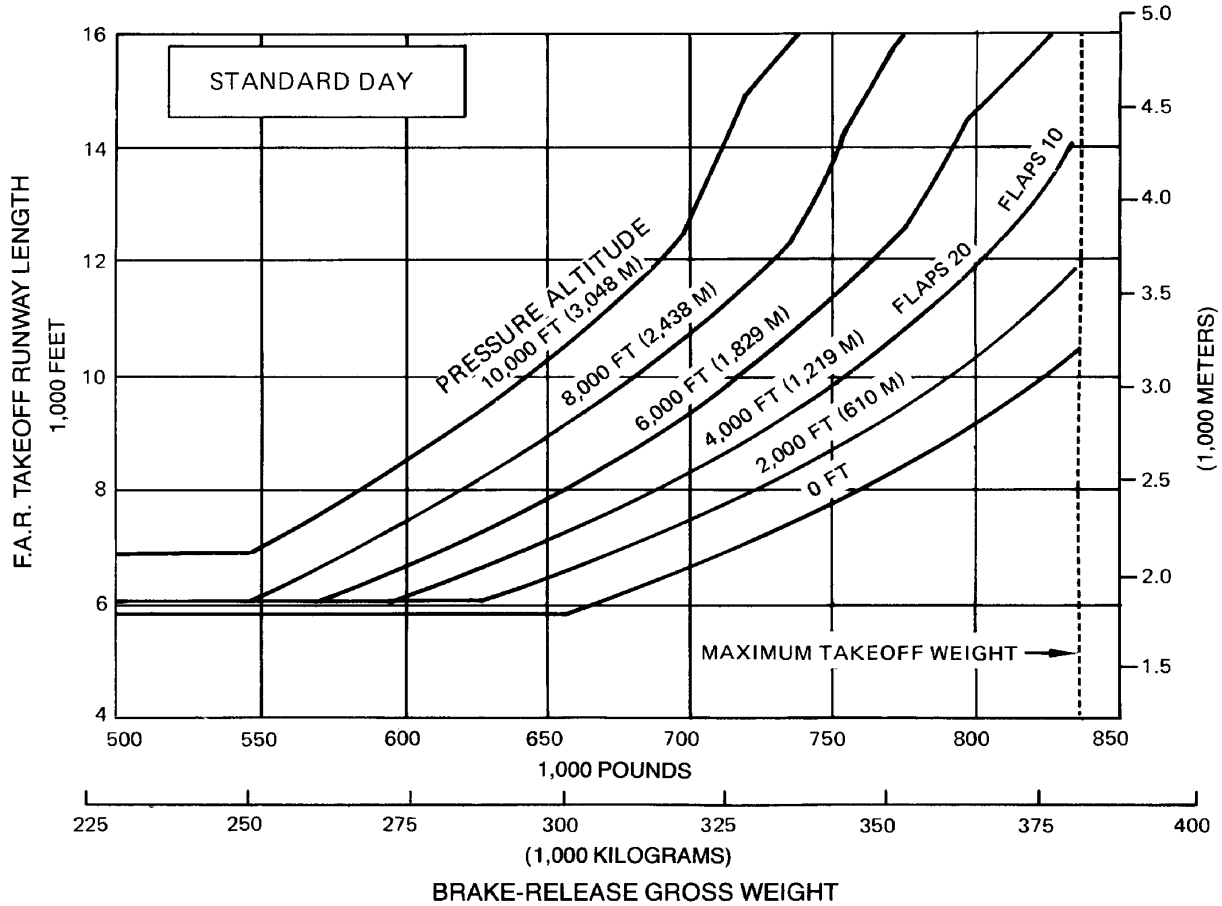

3.3.13 F.A.R. TAKEOFF RUNWAY-LENGTH REQUIREMENTS
STANDARD DAY
 MODEL 747-200 (JT9D-7Q ENGINES)

- NOTES:
- CONSULT USING AIRLINE FOR SPECIFIC OPERATING PROCEDURE PRIOR TO FACILITY DESIGN.
 - AIR CONDITIONING OFF. ONE A/C PACK MAY BE OPERATED BY THE APU WITH NO THRUST PENALTY.
 - ZERO RUNWAY GRADIENT

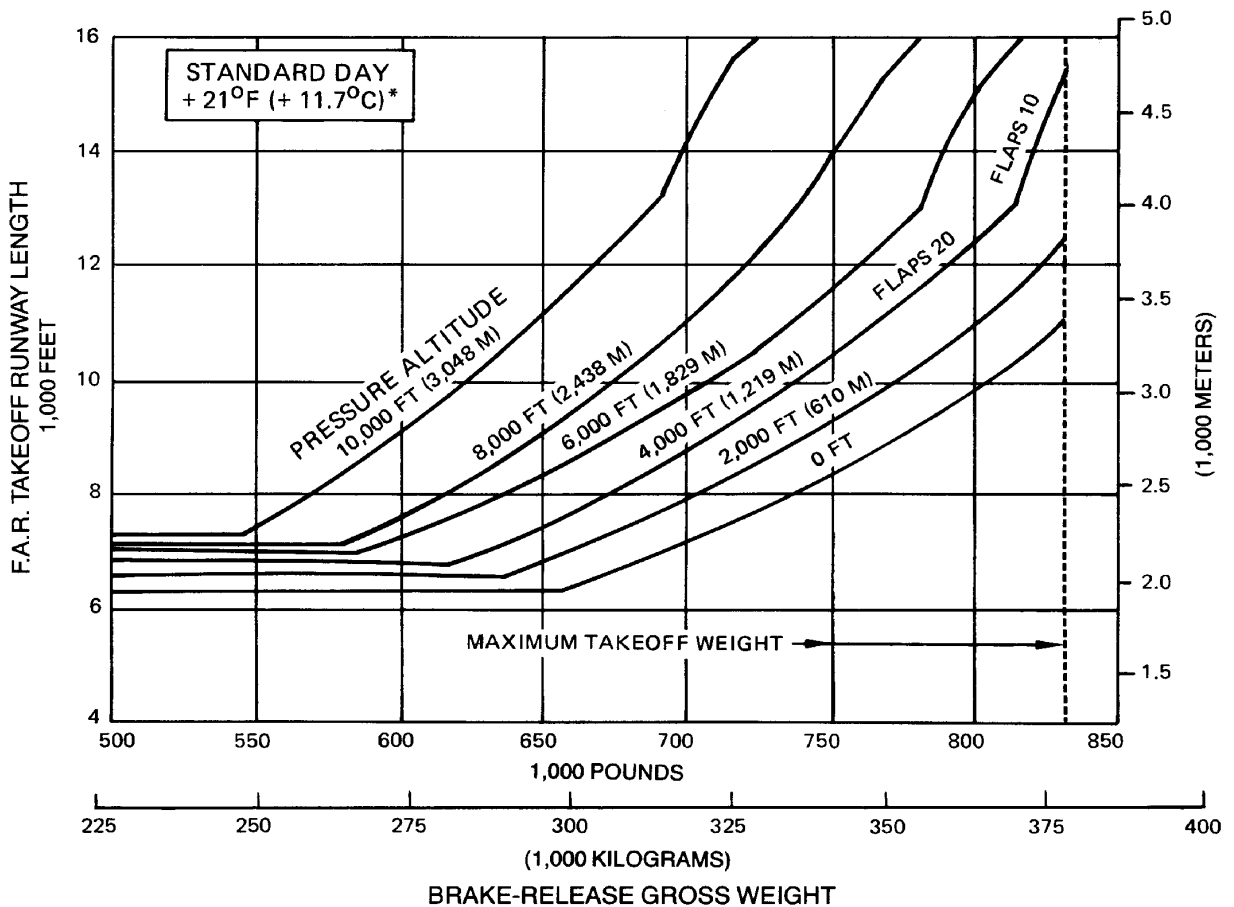

*THE JT9D-7Q ENGINE IS FLAT RATED TO STD + 21°F(+11.7°C).

3.3.14 F.A.R. TAKEOFF RUNWAY-LENGTH REQUIREMENTS
STANDARD DAY +21°F (+11.7°C)*
MODEL 747-200 (JT9D-7Q ENGINES)

- NOTES
- CONSULT USING AIRLINE FOR SPECIFIC OPERATING PROCEDURE PRIOR TO FACILITY DESIGN.
 - AIR CONDITIONING OFF. ONE A/C PACK MAY BE OPERATED BY THE APU WITH NO THRUST PENALTY.
 - ZERO RUNWAY GRADIENT

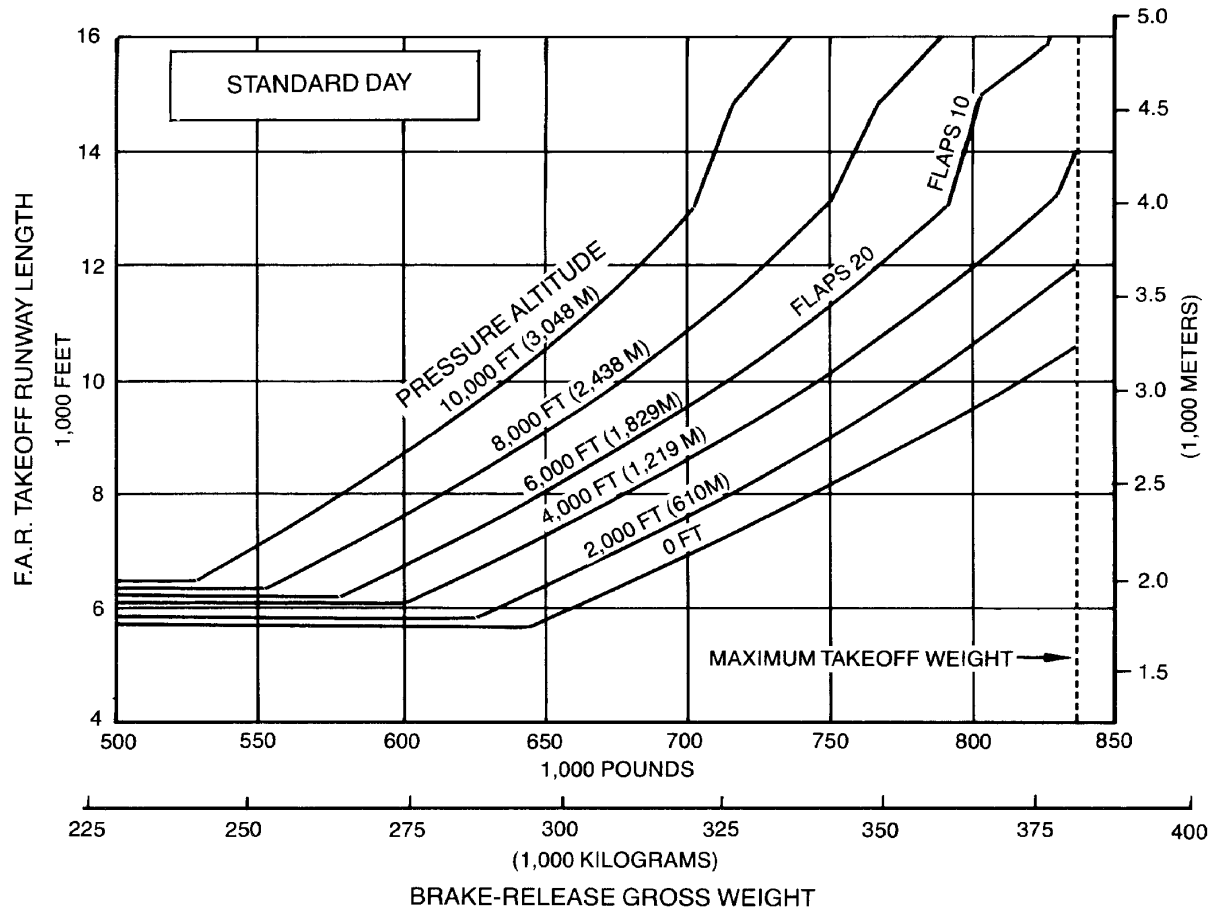

3.3.15 F.A.R. TAKEOFF RUNWAY-LENGTH REQUIREMENTS
STANDARD DAY
MODEL 747-200 (JT9D-70A ENGINES)

- NOTES
- CONSULT USING AIRLINE FOR SPECIFIC OPERATING PROCEDURE PRIOR TO FACILITY DESIGN.
 - AIR CONDITIONING OFF. ONE A/C PACK MAY BE OPERATED BY THE APU WITH NO THRUST PENALTY.
 - ZERO RUNWAY GRADIENT

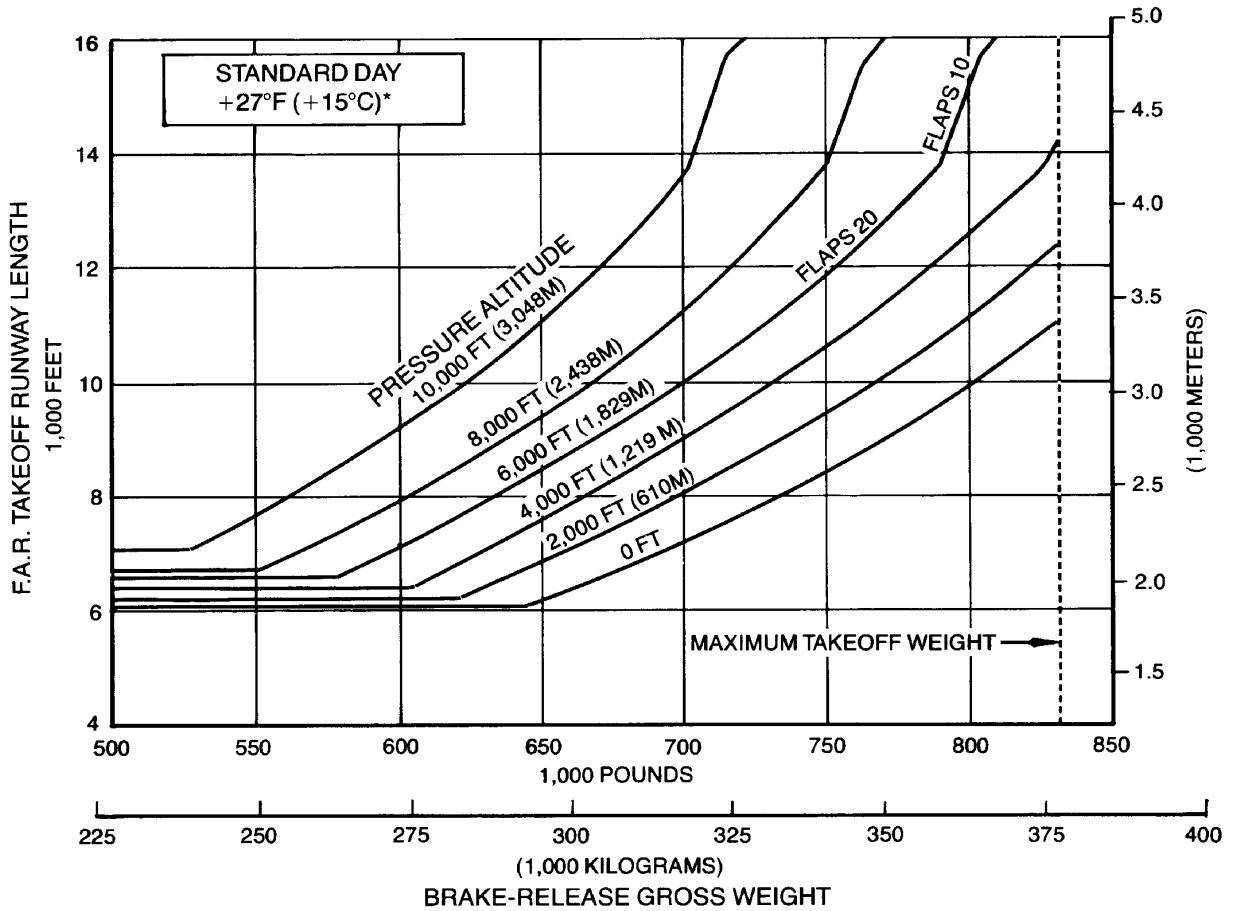

*THE JT9D-70A ENGINE IS FLAT RATED TO STD +27°F (+15°C).

3.3.16 F.A.R. TAKEOFF RUNWAY-LENGTH REQUIREMENTS
STANDARD DAY +27°F (+15°C)*
MODEL 747-200 (JT9D-70A ENGINES)

D6-58326

MAY 1984

87

- NOTES:
- CONSULT USING AIRLINE FOR SPECIFIC OPERATING PROCEDURE PRIOR TO FACILITY DESIGN.
 - AIR CONDITIONING OFF. ONE A/C PACK MAY BE OPERATED BY THE APU WITH NO THRUST PENALTY.
 - ZERO RUNWAY GRADIENT

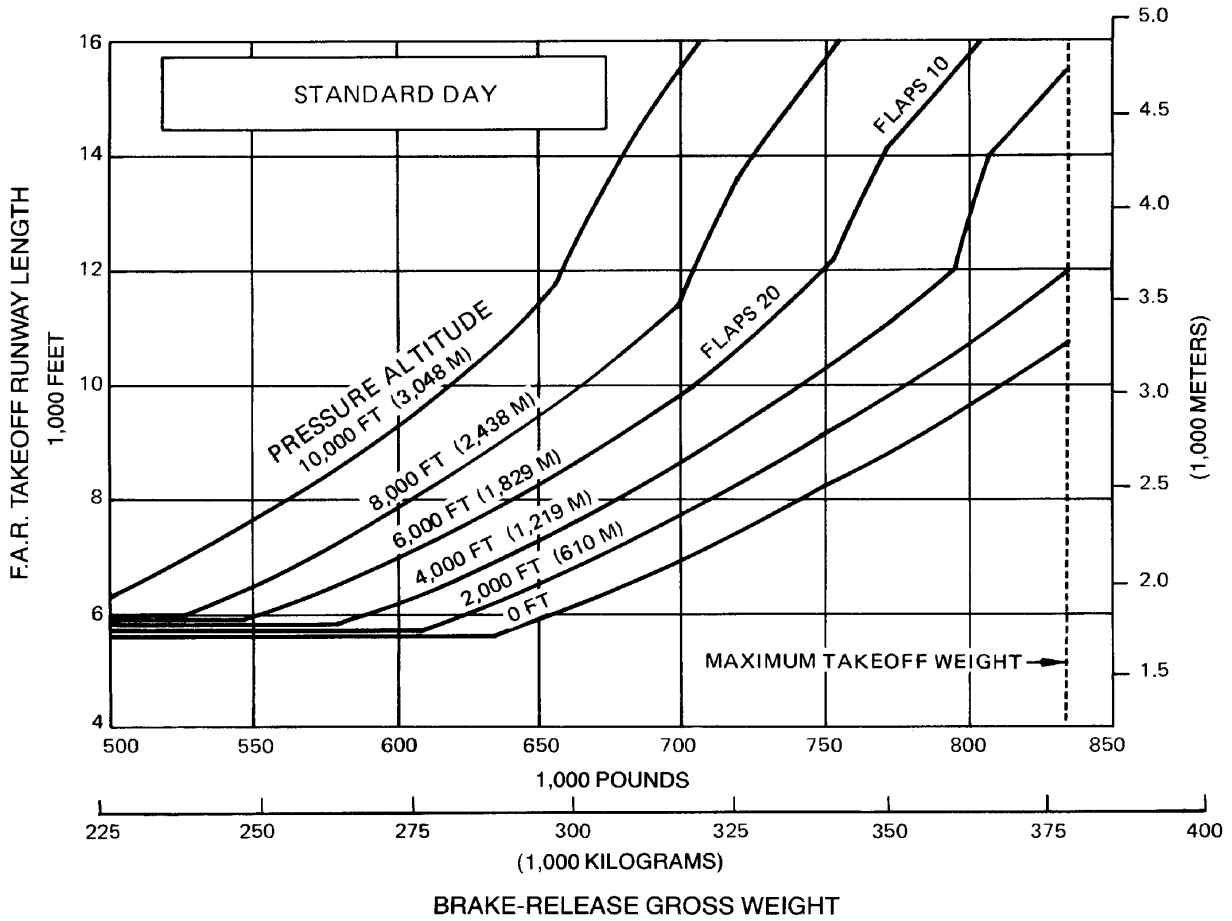

**3.3.17 F.A.R. TAKEOFF RUNWAY-LENGTH REQUIREMENTS
STANDARD DAY
MODELS 747-200, -300(CF6-50E2 ENGINES)**

- NOTES:
- CONSULT USING AIRLINE FOR SPECIFIC OPERATING PROCEDURE PRIOR TO FACILITY DESIGN.
 - AIR CONDITIONING OFF. ONE A/C PACK MAY BE OPERATED BY THE APU WITH NO THRUST PENALTY.
 - ZERO RUNWAY GRADIENT

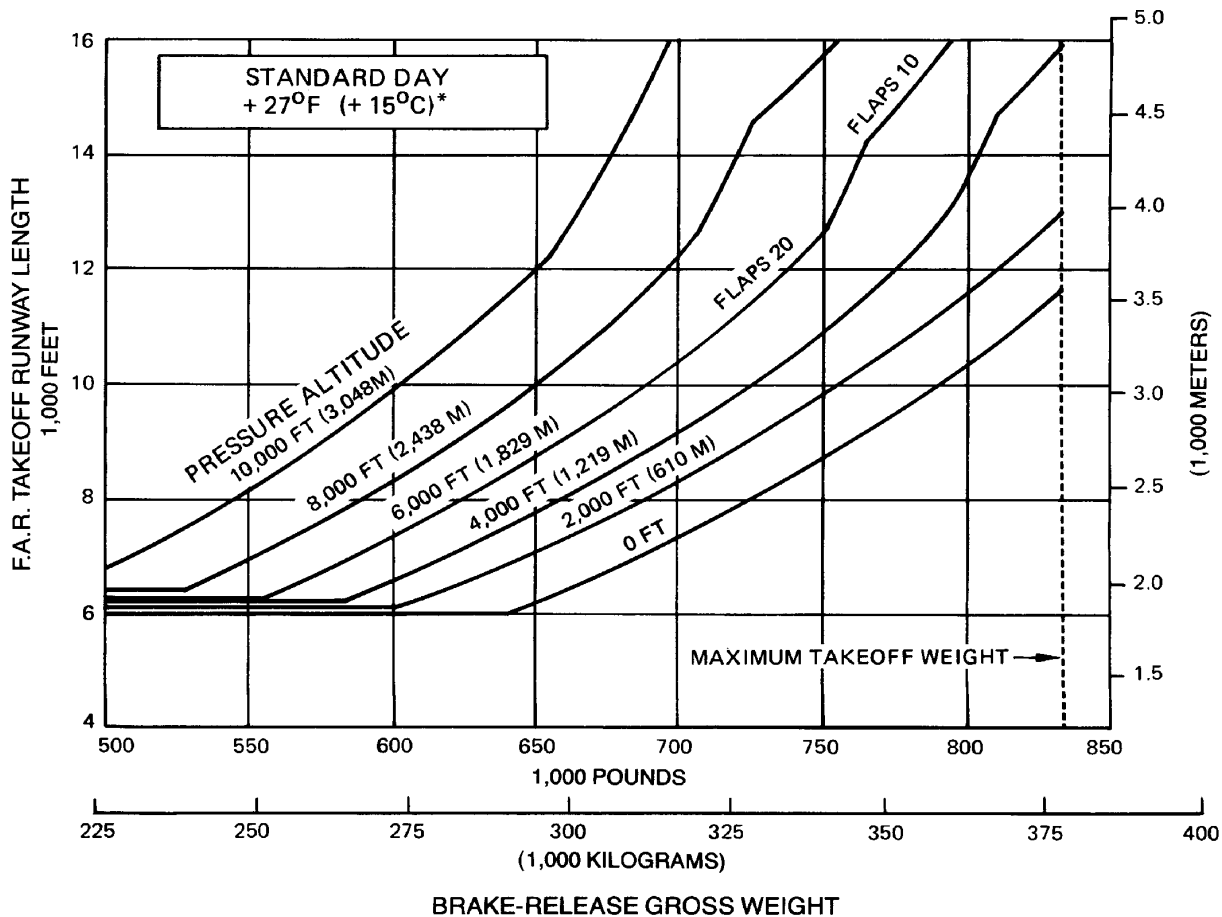

* THE CF6-50E2 ENGINE IS FLAT RATED TO STD + 27°F (+ 15°C).

3.3.18 F.A.R. TAKEOFF RUNWAY-LENGTH REQUIREMENTS
STANDARD DAY +27°F (+15°C)*
MODELS 747-200, -300 (CF6-50E2 ENGINES)

- NOTES
- CONSULT USING AIRLINE FOR SPECIFIC OPERATING PROCEDURE PRIOR TO FACILITY DESIGN.
 - AIR CONDITIONING OFF. ONE A/C PACK MAY BE OPERATED BY THE APU WITH NO THRUST PENALTY.
 - ZERO RUNWAY GRADIENT

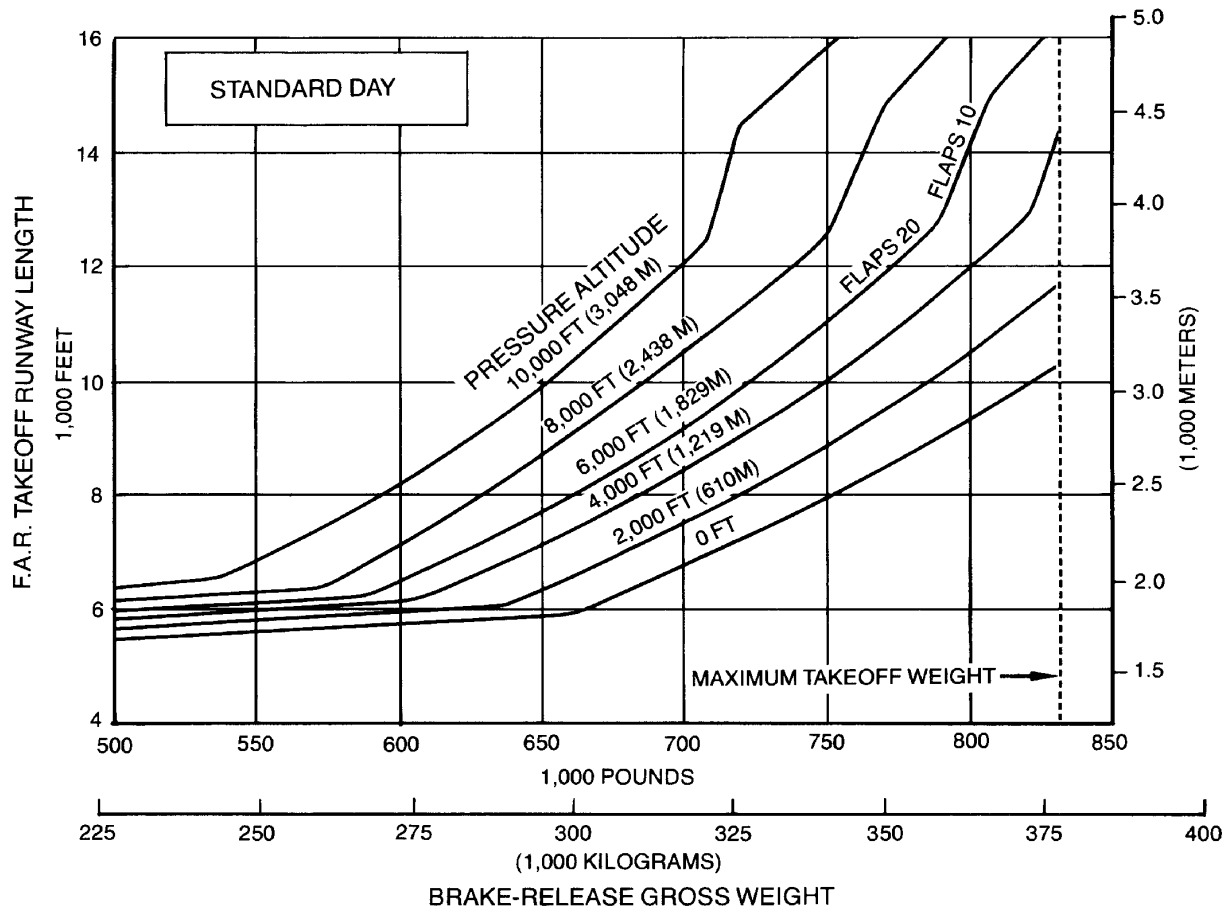

**3.3.19 F.A.R. TAKEOFF RUNWAY-LENGTH REQUIREMENTS
STANDARD DAY
MODELS 747-200, -300 (JT9D-7R4G2 ENGINES)**

- NOTES
- CONSULT USING AIRLINE FOR SPECIFIC OPERATING PROCEDURE PRIOR TO FACILITY DESIGN.
 - AIR CONDITIONING OFF. ONE A/C PACK MAY BE OPERATED BY THE APU WITH NO THRUST PENALTY.
 - ZERO RUNWAY GRADIENT

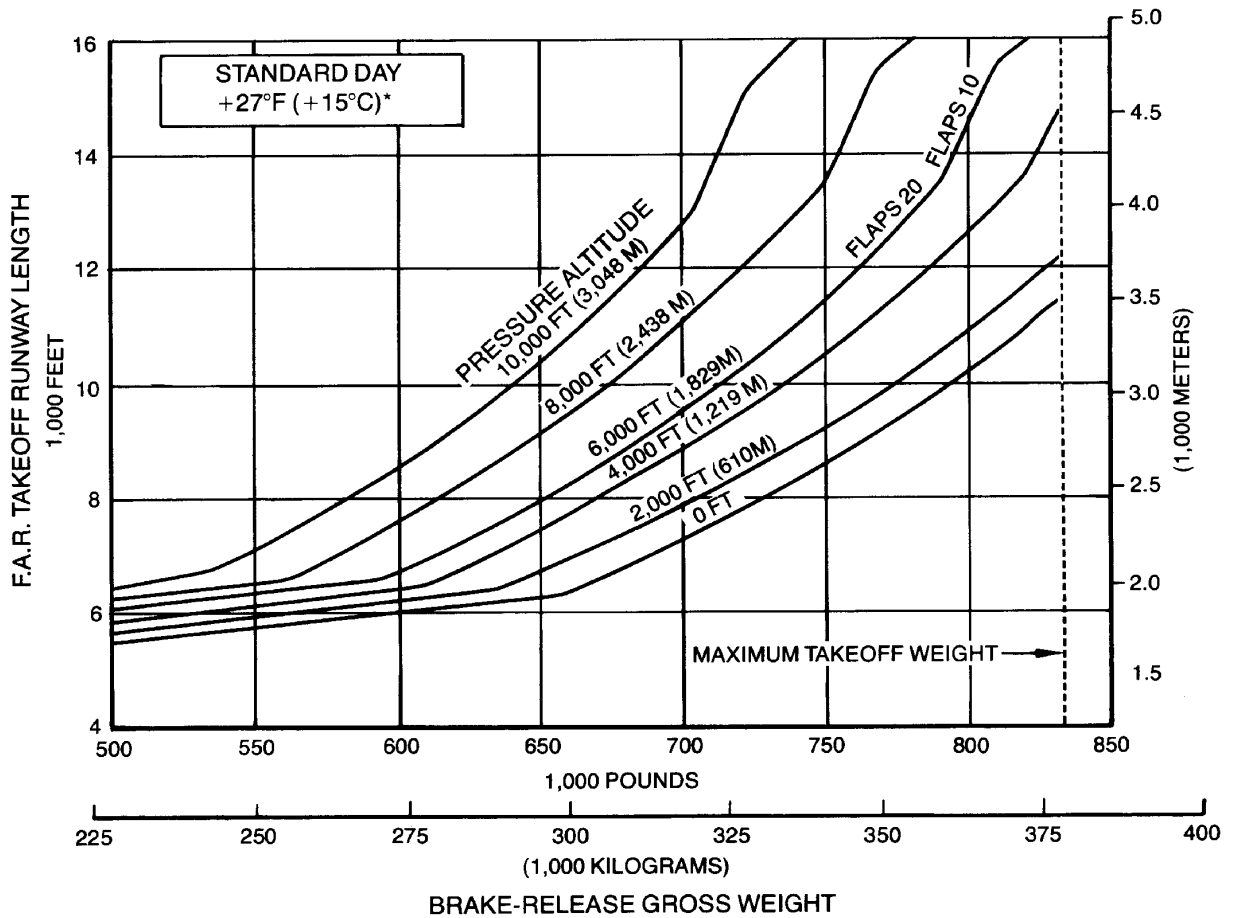

*THE JT9D-7R4G2 ENGINE IS FLAT RATED TO STD +27°F (+15°C).

3.3.20 F.A.R. TAKEOFF RUNWAY-LENGTH REQUIREMENTS
STANDARD DAY +27°F (+15°C)*
 MODELS 747-200, -300 (JT9D-7R4G2 ENGINES)

D6-58326

MAY 1984

91

- NOTES
- CONSULT USING AIRLINE FOR SPECIFIC OPERATING PROCEDURE PRIOR TO FACILITY DESIGN.
 - AIR CONDITIONING OFF. ONE A/C PACK MAY BE OPERATED BY THE APU WITH NO THRUST PENALTY.
 - ZERO RUNWAY GRADIENT

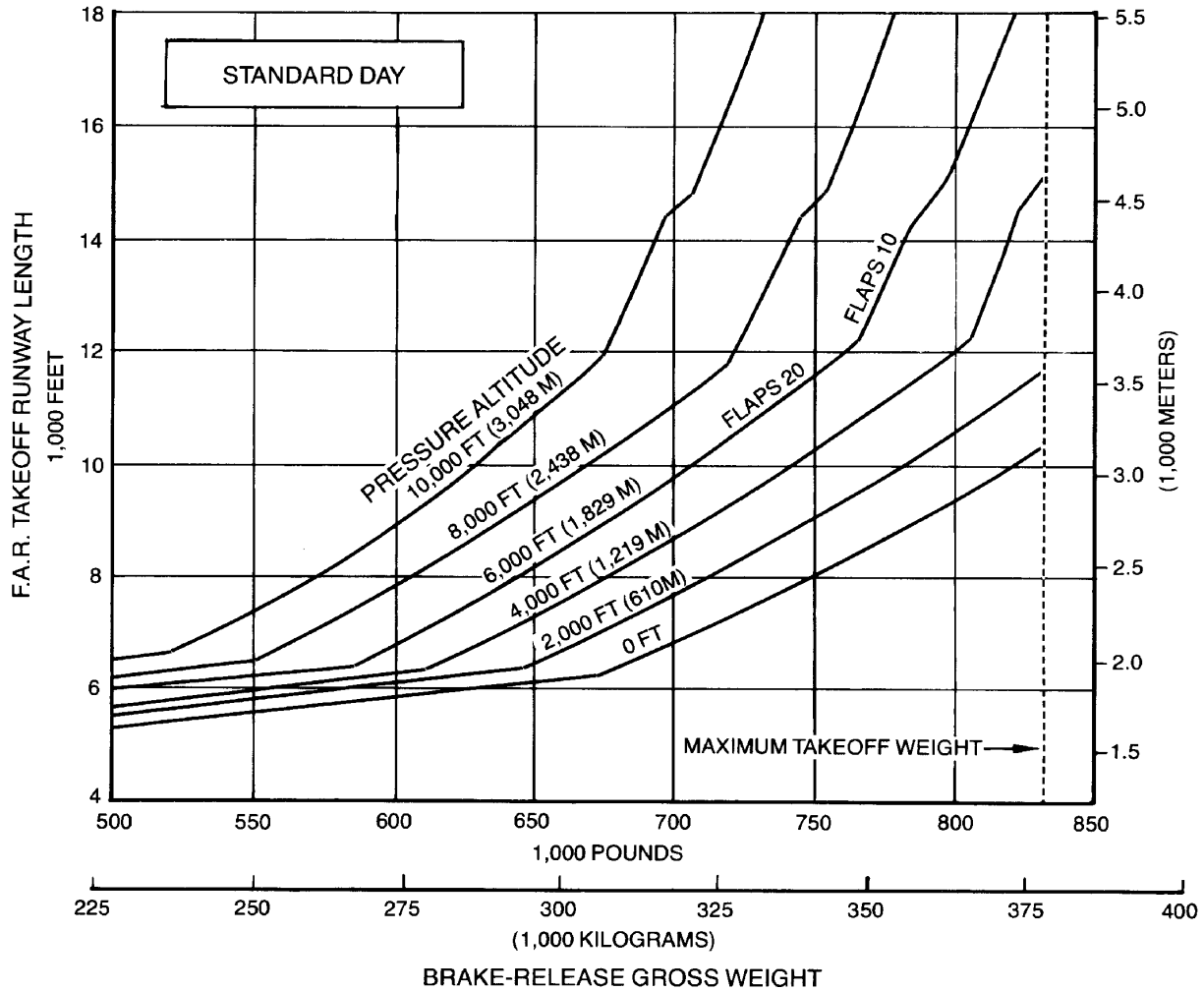

**3.3.21 F.A.R TAKEOFF RUNWAY-LENGTH REQUIREMENTS
STANDARD DAY
MODELS 747-200, -300 (RB211-524D4 ENGINES)**

- NOTES
- CONSULT USING AIRLINE FOR SPECIFIC OPERATING PROCEDURE PRIOR TO FACILITY DESIGN.
 - AIR CONDITIONING OFF. ONE A/C PACK MAY BE OPERATED BY THE APU WITH NO THRUST PENALTY.
 - ZERO RUNWAY GRADIENT

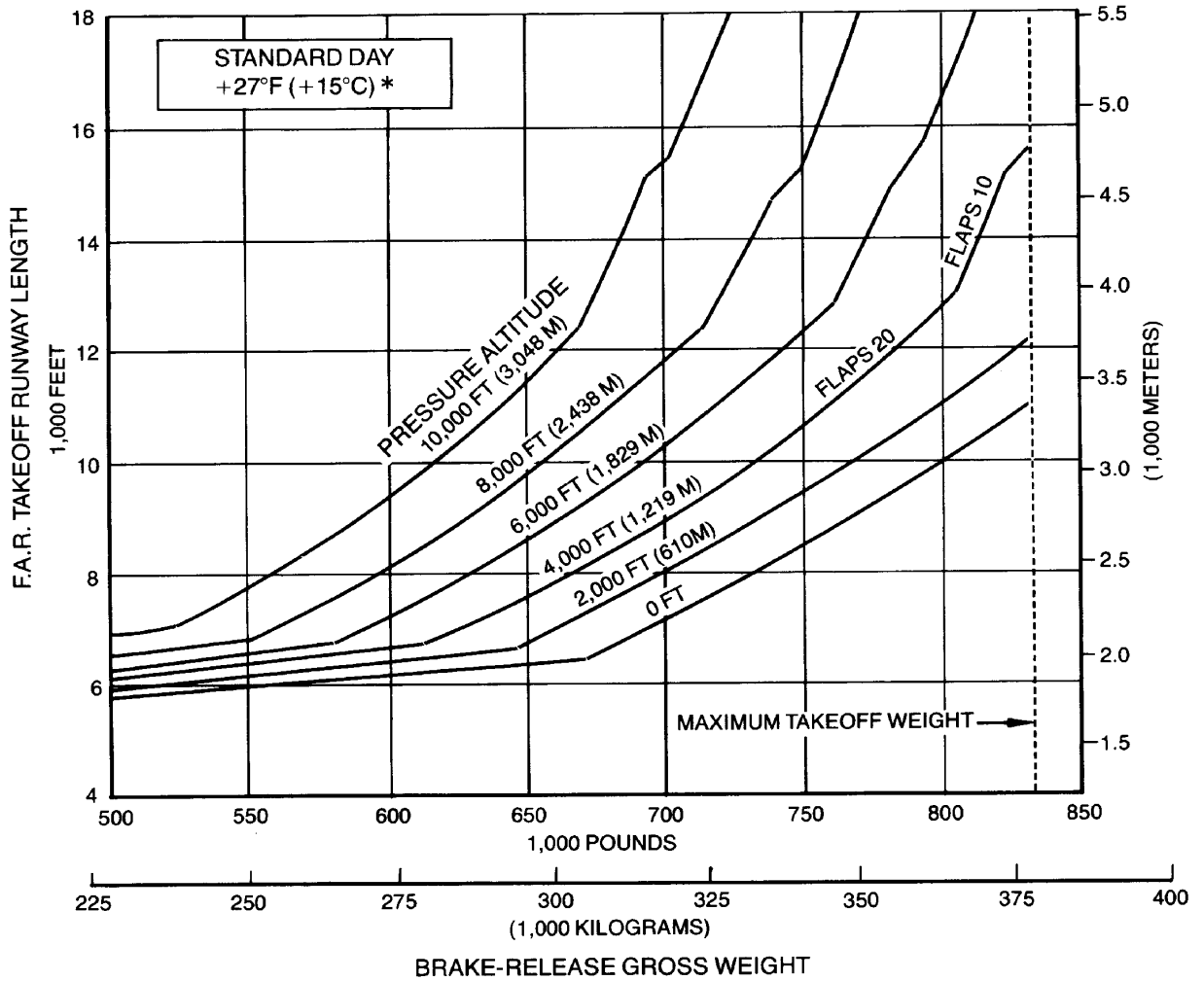

* THE RB211-524D4 ENGINE IS FLAT RATED TO STD +27°F (+15°C).

**3.3.22 F.A.R. TAKEOFF RUNWAY-LENGTH REQUIREMENTS
STANDARD DAY +27°F (+15°C)*
MODELS 747-200, -300 (RB211-524D4 ENGINES)**

- NOTES:
- CONSULT USING AIRLINE FOR SPECIFIC OPERATING PROCEDURE PRIOR TO FACILITY DESIGN.
 - AIR CONDITIONING OFF. ONE A/C PACK MAY BE OPERATED BY THE APU WITH NO THRUST PENALTY.
 - ZERO RUNWAY GRADIENT

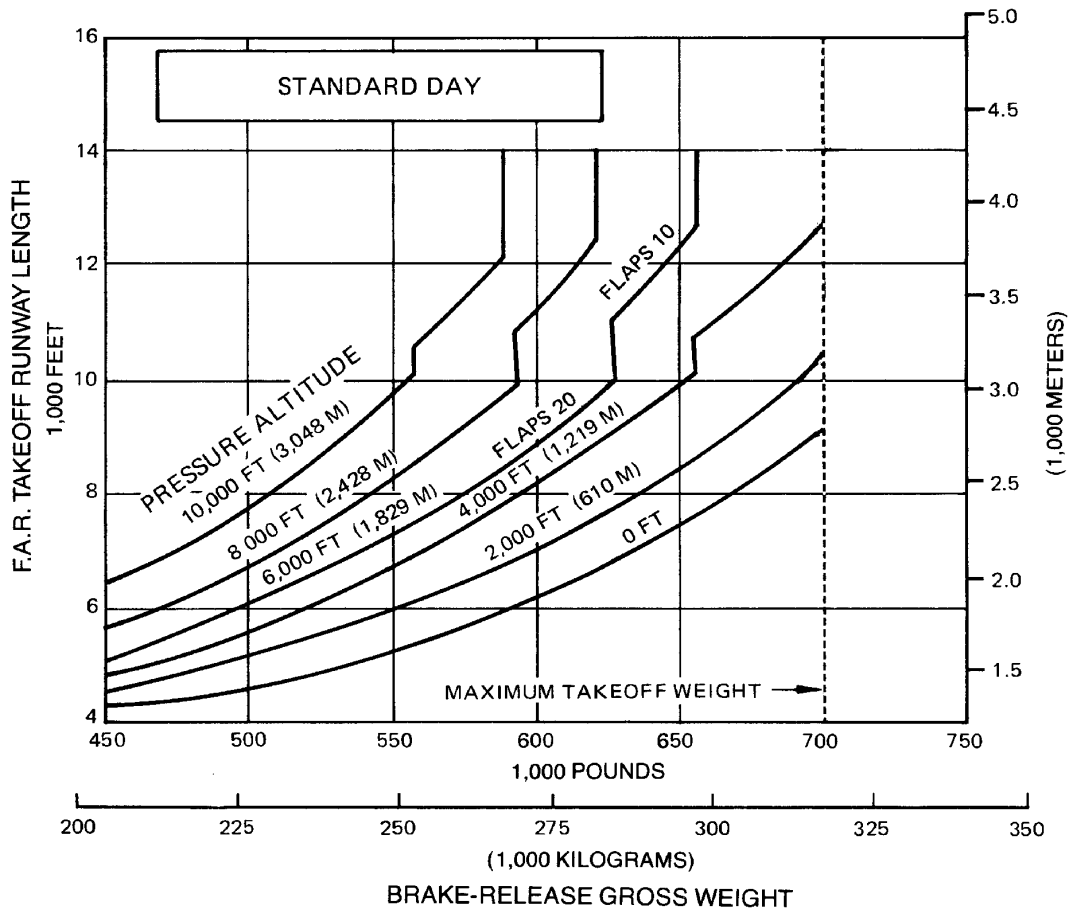

3.3.23 F.A.R. TAKEOFF RUNWAY-LENGTH REQUIREMENTS
STANDARD DAY
MODEL 747SP (JT9D-7A ENGINES)

- NOTES:
- CONSULT USING AIRLINE FOR SPECIFIC OPERATING PROCEDURE PRIOR TO FACILITY DESIGN.
 - AIR CONDITIONING OFF. ONE A/C PACK MAY BE OPERATED BY THE APU WITH NO THRUST PENALTY.
 - ZERO RUNWAY GRADIENT

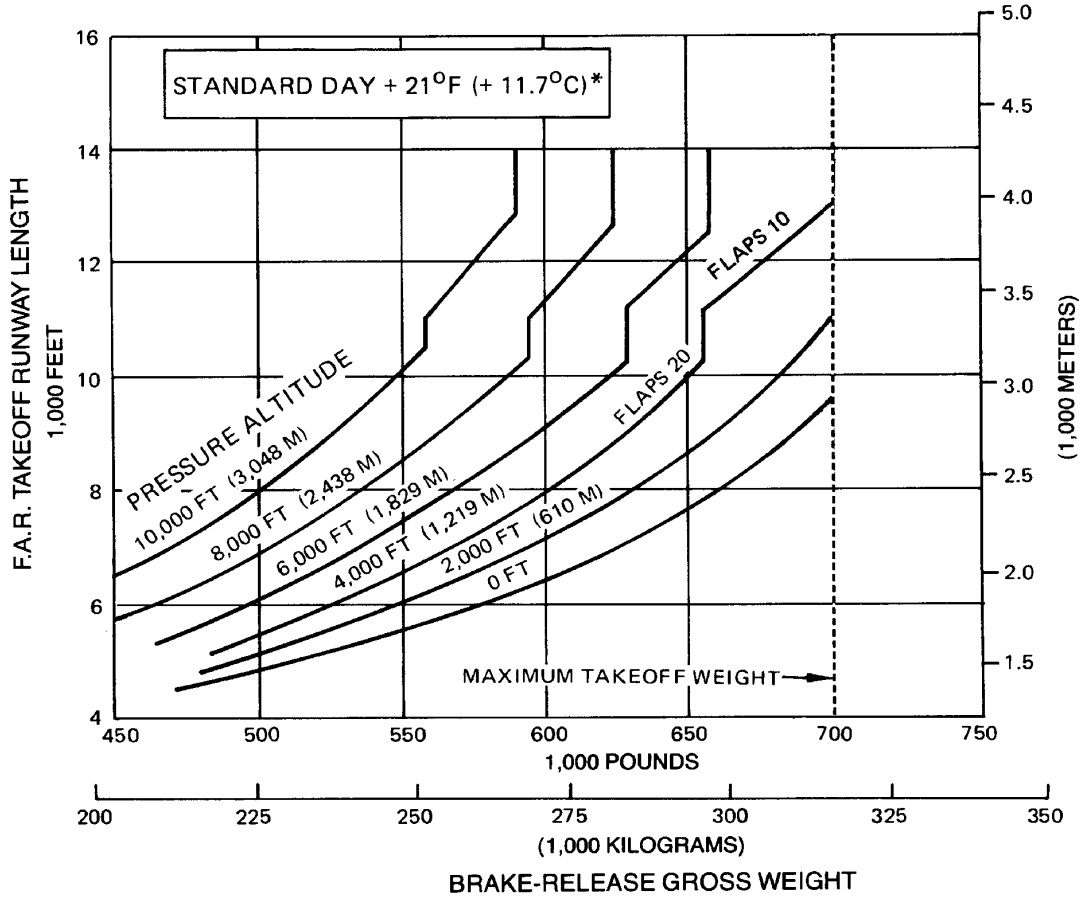

*THE JT9D-7A ENGINE IS FLAT RATED TO STD + 21°F (+ 11.7°C).

3.3.24 F.A.R. TAKEOFF RUNWAY-LENGTH REQUIREMENTS
STANDARD DAY +21°F (+11.7°C)*
MODEL 747SP (JT9D-7A ENGINES)

- NOTES:
- CONSULT USING AIRLINE FOR SPECIFIC OPERATING PROCEDURE PRIOR TO FACILITY DESIGN.
 - AIR CONDITIONING OFF. ONE A/C PACK MAY BE OPERATED BY THE APU WITH NO THRUST PENALTY.
 - ZERO RUNWAY GRADIENT

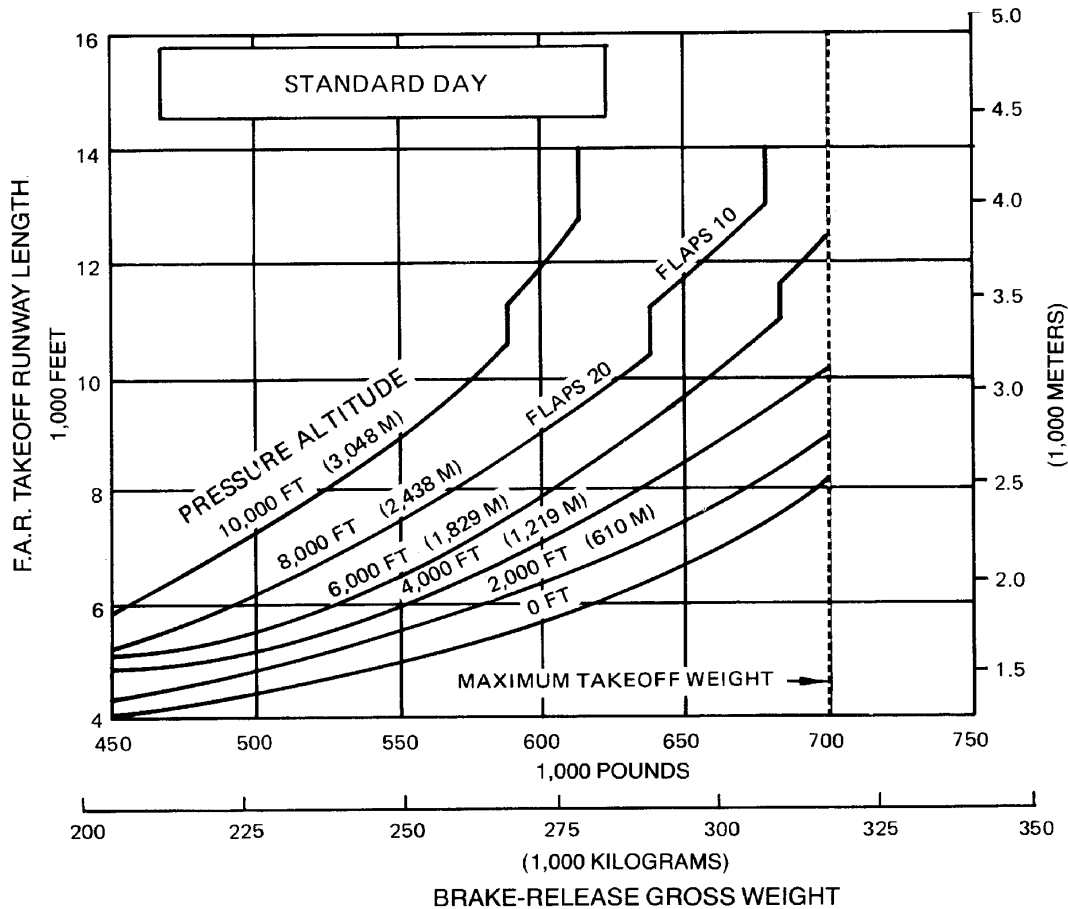

**3.3.25 F.A.R. TAKEOFF RUNWAY-LENGTH REQUIREMENTS
STANDARD DAY
MODEL 747SP (JT9D-7FW ENGINES)**

- NOTES:
- CONSULT USING AIRLINE FOR SPECIFIC OPERATING PROCEDURE PRIOR TO FACILITY DESIGN.
 - AIR CONDITIONING OFF. ONE A/C PACK MAY BE OPERATED BY THE APU WITH NO THRUST PENALTY.
 - ZERO RUNWAY GRADIENT

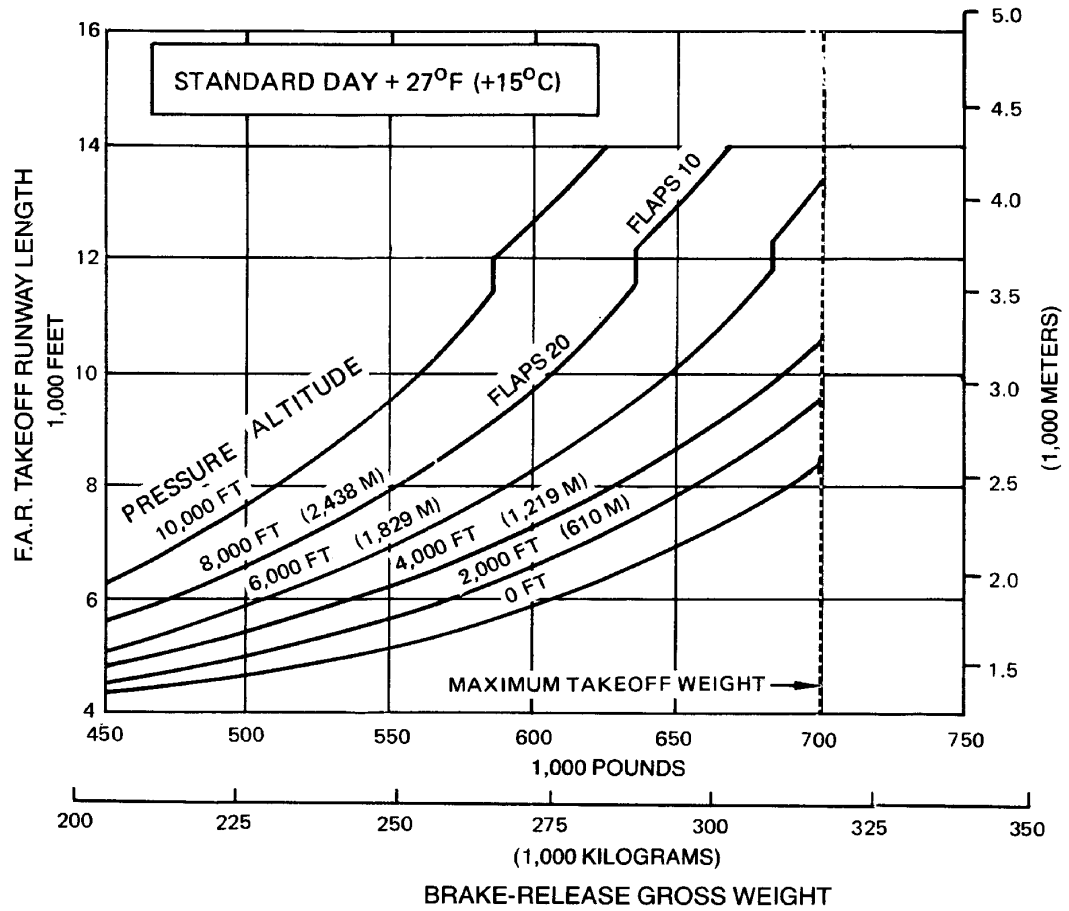

*THE JT9D-7FW ENGINE IS FLAT RATED TO STD + 27°F (+ 15°C).

3.3.26 F.A.R. TAKEOFF RUNWAY-LENGTH REQUIREMENTS
STANDARD DAY +27°F (+15°C)*
MODEL 747SP (JT9D-7FW ENGINES)

D6-58326

MAY 1984

97

- NOTES
- CONSULT USING AIRLINE FOR SPECIFIC OPERATING PROCEDURE PRIOR TO FACILITY DESING.
 - AIR CONDITIONING OFF. ONE A/C PACK MAY BE OPERATED BY THE APU WITH NO THRUST PENALTY.
 - ZERO RUNWAY GRADIENT

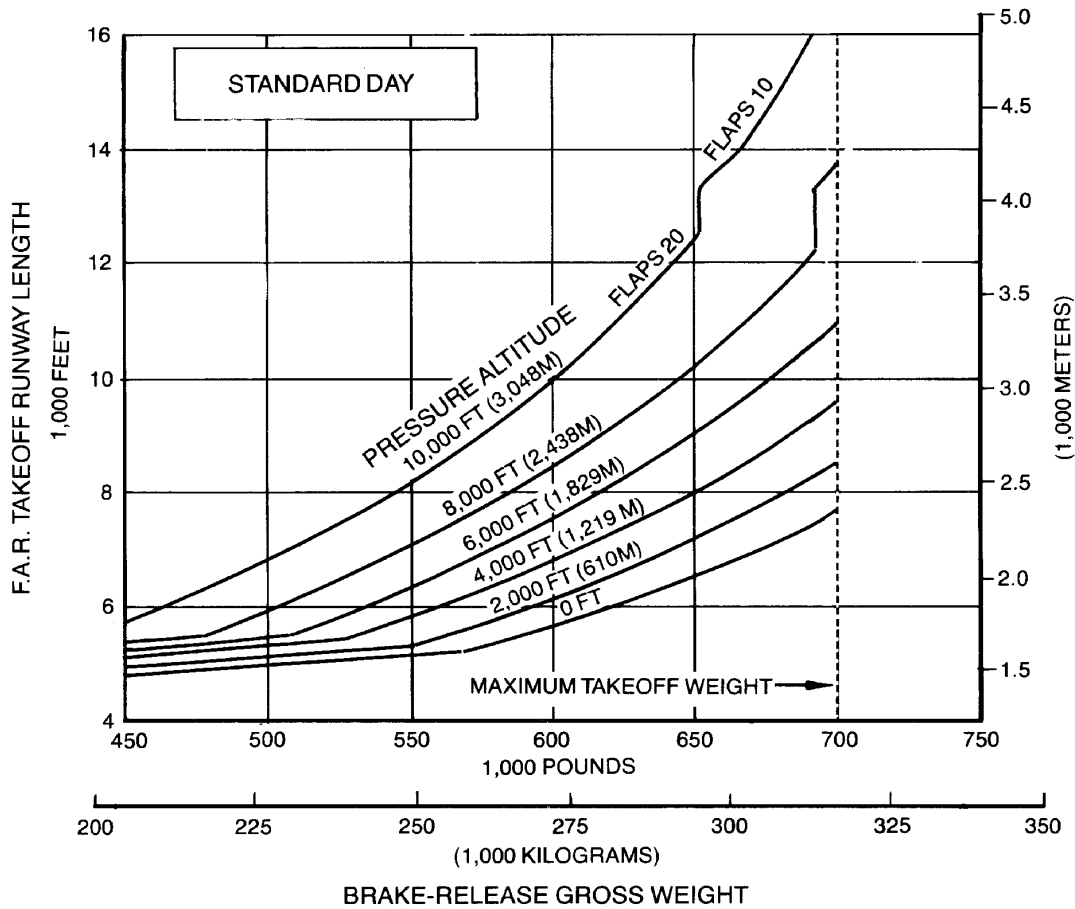

3.3.27 F.A.R. TAKEOFF RUNWAY-LENGTH REQUIREMENTS
STANDARD DAY
 MODEL 747SP (RB211-524B2, C2 ENGINES)

- NOTES:
- CONSULT USING AIRLINE FOR SPECIFIC OPERATING PROCEDURE PRIOR TO FACILITY DESIGN.
 - AIR CONDITIONING OFF. ONE A/C PACK MAY BE OPERATED BY THE APU WITH NO THRUST PENALTY.
 - ZERO RUNWAY GRADIENT

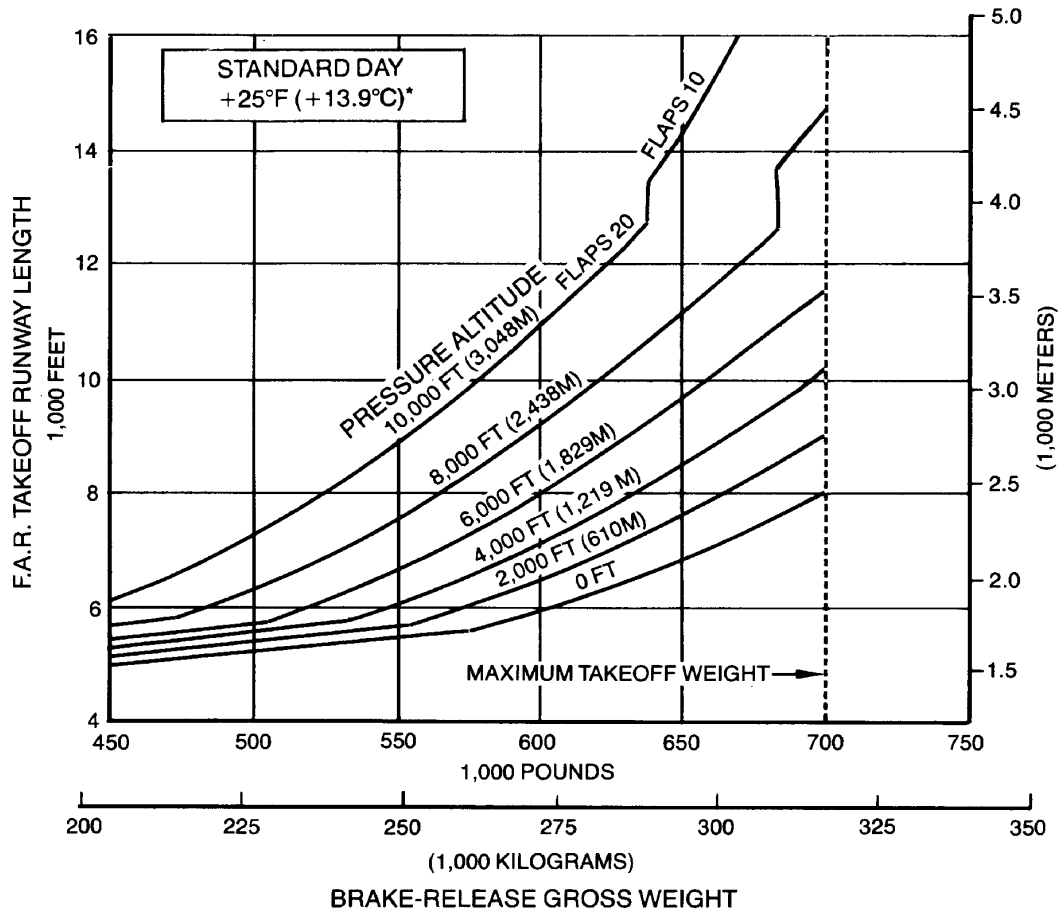

*THE RB 211-524 B2, C2 ENGINES ARE FLAT RATED TO STD +25°F (+13.9°C).

3.3.28 F.A.R TAKEOFF RUNWAY-LENGTH REQUIREMENTS STANDARD DAY +25°F (+13.9°C)* MODEL 747SP (RB211-524B2, C2 ENGINES)

D6-58326

MAY 1984

99

- NOTES:
- AUTO SPOILERS
 - 45° INBOARD SPOILER
 - ANTISKID IMPROVEMENT
 - CONSULT USING AIRLINE FOR SPECIFIC OPERATING PROCEDURE PRIOR TO FACILITY DESIGN

LEGEND ——— WET RUNWAY
 - - - - - DRY RUNWAY

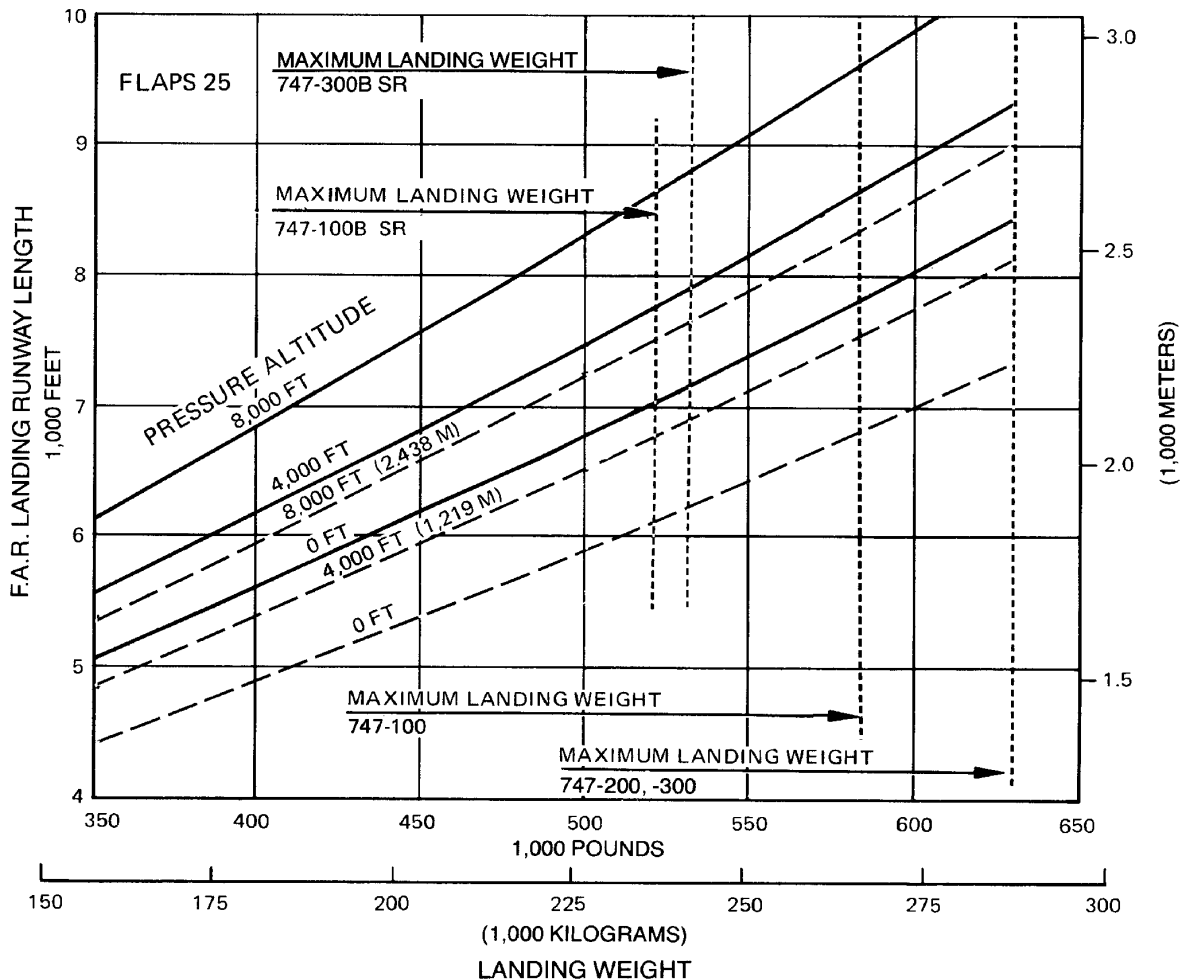

3.4.1 F.A.R. LANDING RUNWAY-LENGTH REQUIREMENTS — FLAPS 25
 MODELS 747-100, -200, -300

- NOTES:
- AUTO SPOILERS
 - 45° INBOARD SPOILER
 - ANTISKID IMPROVEMENT
 - CONSULT USING AIRLINE FOR SPECIFIC OPERATING PROCEDURE PRIOR TO FACILITY DESIGN

LEGEND ——— WET RUNWAY
 - - - - - DRY RUNWAY

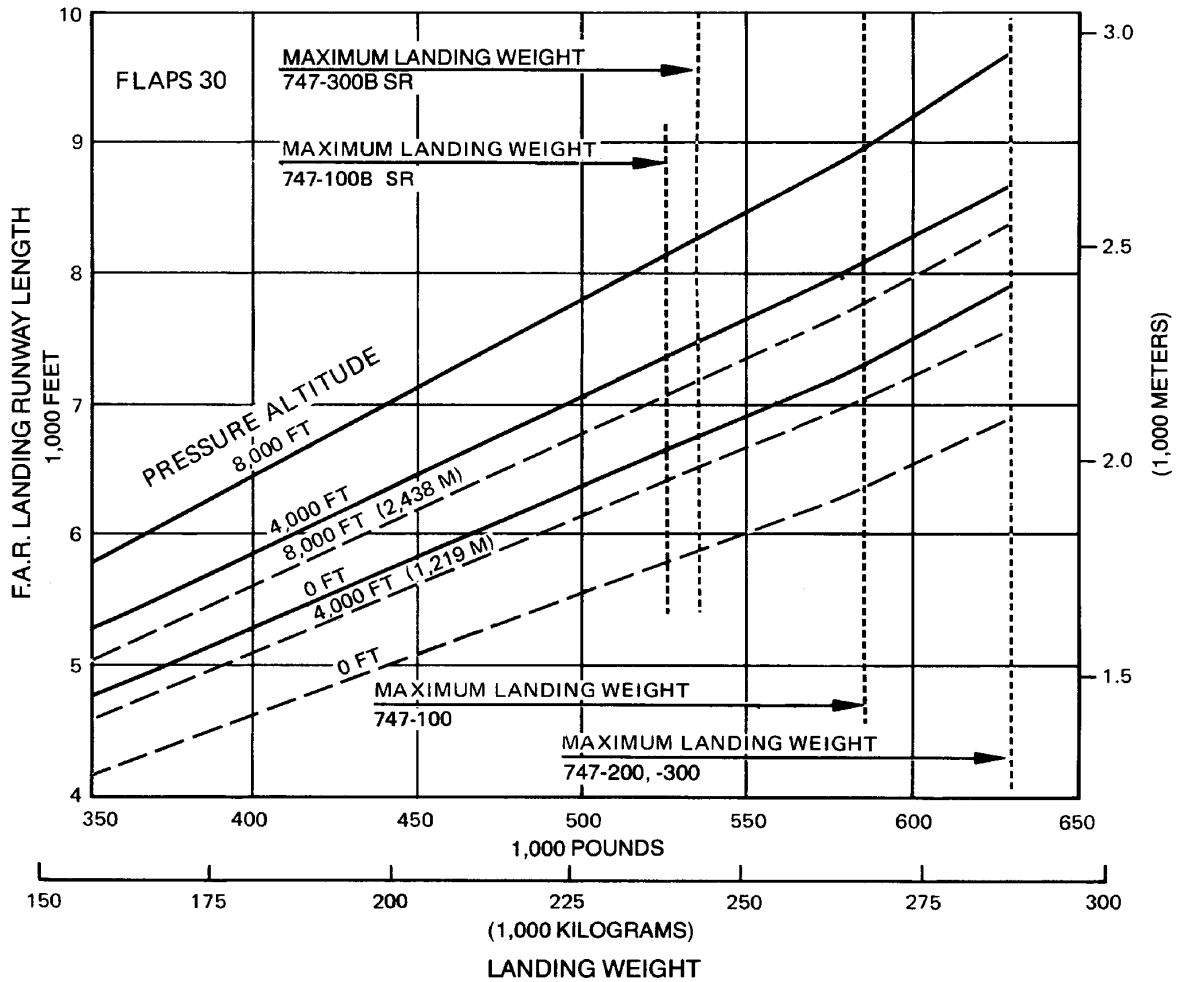

3.4.2 F.A.R. LANDING RUNWAY-LENGTH REQUIRMENTS — FLAPS 30
 MODELS 747-100, -200, -300

D6-58326

MAY 1984

101

NOTE: ● CONSULT USING AIRLINE FOR SPECIFIC OPERATING PROCEDURE PRIOR TO FACILITY DESIGN.

LEGEND ——— WET RUNWAY
 - - - - - DRY RUNWAY

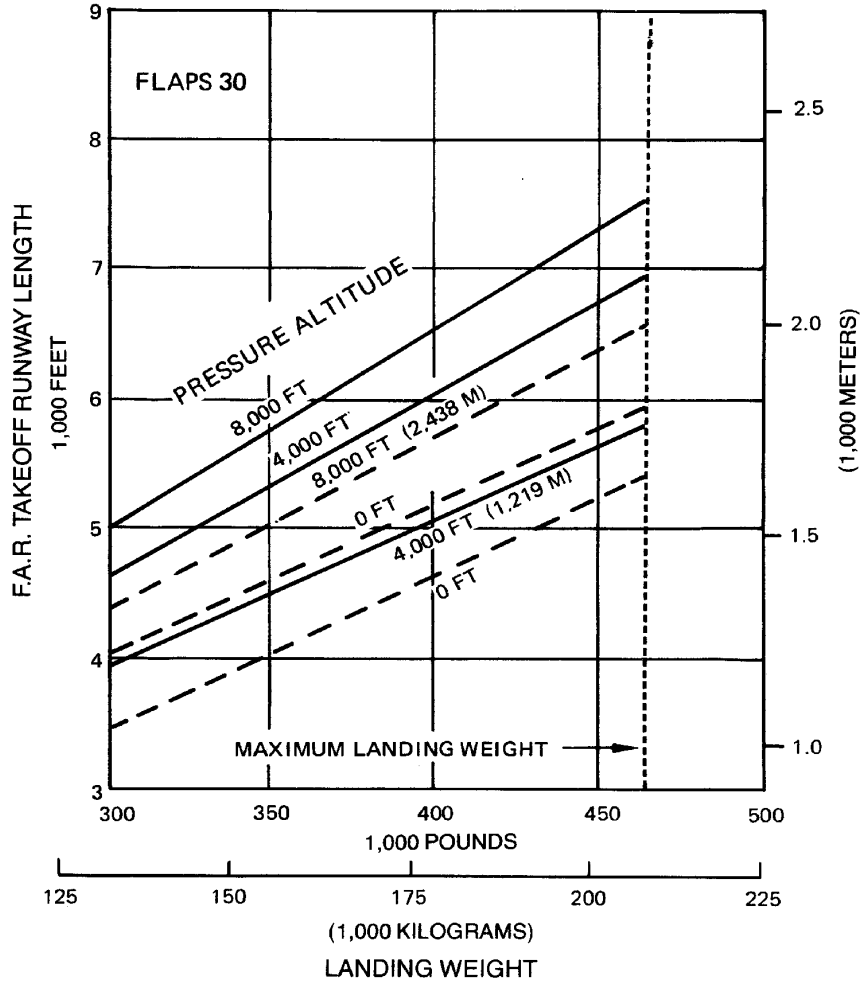

3.4.3 F.A.R. LANDING RUNWAY-LENGTH REQUIREMENTS MODEL 747SP

- 4.0 GROUND MANEUVERING**
 - 4.1 General Information**
 - 4.2 Turning Radii**
 - 4.3 Clearance Radii**
 - 4.4 Visibility from Cockpit in Static Position**
 - 4.5 Runway and Taxiway Turn Paths**
 - 4.6 Runway Holding Bay**

4.0 GROUND MANEUVERING

4.1 General Information

The 747 main landing gear consists of four main struts (16 tires). This geometric arrangement of the four main gears results in somewhat different ground maneuvering characteristics from those experienced with typical landing gear aircraft.

Basic factors that influence the geometry of a turn:

1. Degree of nose wheel steering angle
2. Engine power settings
3. Center-of-gravity location
4. Ramp weight
5. Pavement surface conditions
6. Amount of differential braking
7. Ground speed
8. Main landing gear steering

The steering system of the 747 incorporates steering of the main body landing gear in addition to nose gear steering. This body gear steering system is hydraulically actuated and is programmed electrically to provide steering ratios proportionate to the nose gear steering angles. During takeoff and landing, the body gear steering system is centered, mechanically locked, and depressurized.

Steering of the main body gear has the following advantages over ground maneuvering without this steering feature: overall improved maneuverability, including improved nose gear tracking; elimination of the need for differential braking during ground turns with subsequent reduced brake wear; reduced thrust requirements; lower main gear stress levels; and reduced tire scrubbing.

Sections 4.2 and 4.3 show turning radii for various nose-gear steering angles and turning radii. Radii for the main and nose gears are measured from the outside edge of the tire, rather than from the center of the wheel strut.

Section 4.4 shows the pilot's visibility from the cockpit within the limits of ambinoocular vision through the windows. Ambinoocular vision is defined as the total field of vision seen by both eyes at the same time.

Section 4.5 shows approximate turn paths of the nose and main landing gears at runway and taxiway intersections. The illustrations show approximate pavement clearances for different pavement configurations and turning procedures.

Section 4.6 shows minimum holding bay requirements.

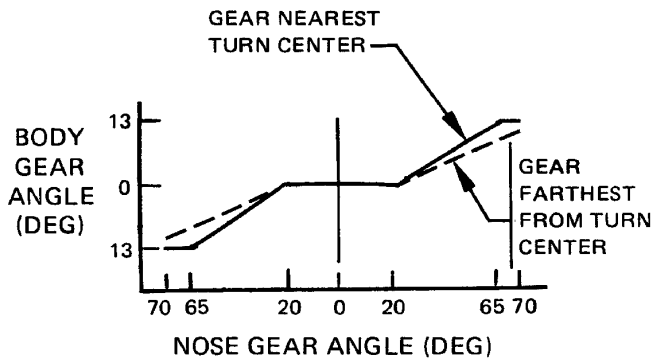
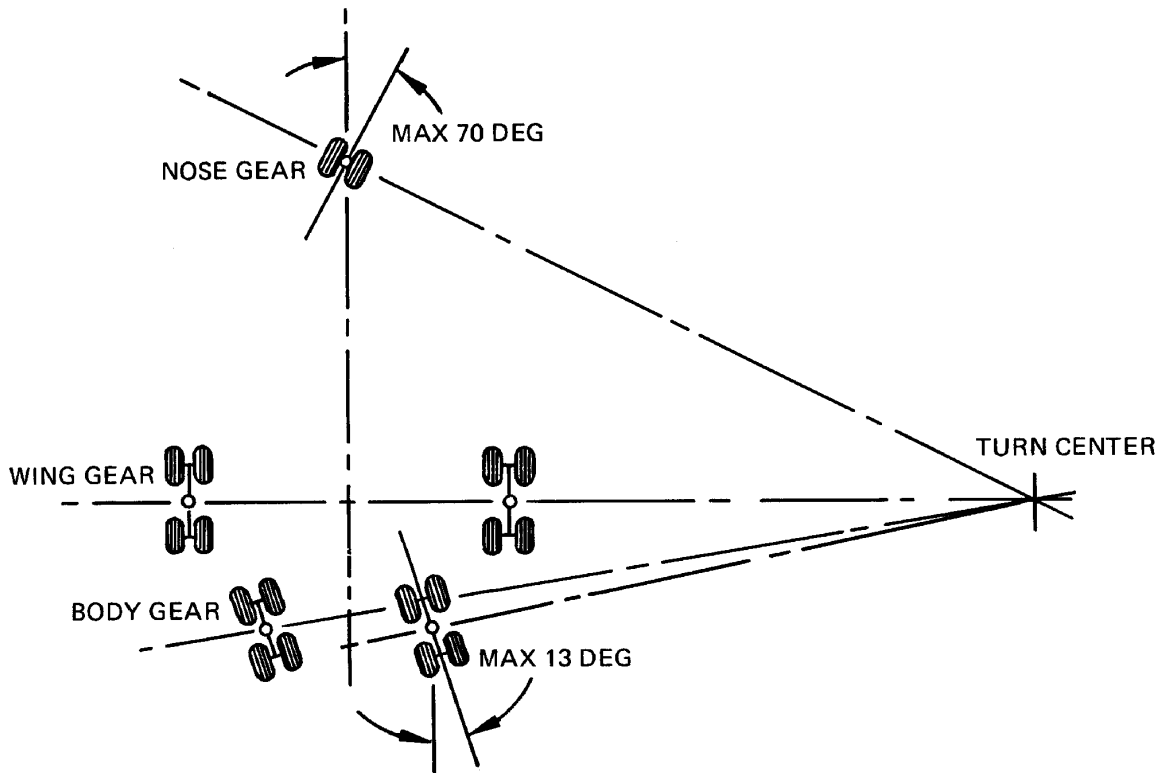

NOSE GEAR	BODY GEAR
0 (DEG) TO 20 (DEG)	0 (DEG)
20 (DEG) TO 70 (DEG)	0 (DEG) TO 13 (DEG)

NOSE/BODY GEAR TURN RATIOS

**4.1.1 GENERAL INFORMATION BODY GEAR STEERING SYSTEM
MODEL 747**

4.2 Turning Radii

This section shows the relationship between nose gear steering angle and airplane turn radius. The geometry of the landing gear and the use of body gear steering presents two sets of circumstances where turning radius could be calculated. With body gear steering operating, the turn center passes through the wing landing gears. With the body gear steering not operating, the turn center passes approximately halfway between the wing gear and body gear. Data in the graphs were calculated from a test program involving the 747-100 and -200 airplanes with different weights. Data for the 747SP were calculated based on the results of the -100/-200 test. The landing gear system for the -300 is the same as for the -200, so data for the -200 also applies to the -300.

4.3 Clearance Radii

The tables show the relationship between the turn radius and critical points of the airplane, including the nose gear, nose, wingtip antenna, tail, and main gear tires. Minimum pavement requirements for certain turn radii are also shown.

- NOTES:
- 747-100 AIRPLANE AT 430,000 LB (195,220 KG) (C.G. 27% MAC) AND 600,000 LB (272,400 KG) (C.G. 30% MAC)
 - 747-200 AIRPLANE AT 800,000 LB (363,200 KG) (C.G. 15% MAC)
 - 747SP AIRPLANE AT 600,000 LB (272,400 KG) (C.G. 15% MAC)
 - LOW SPEED 7-25 FT (2.1-7.6 M) PER SEC.
 - NO DIFFERENTIAL BRAKING
 - DRY CONCRETE PAVEMENT
 - 747-300 AIRPLANE AT SAME WEIGHT AND C.G. AS ABOVE -100 OR -200 AIRPLANE

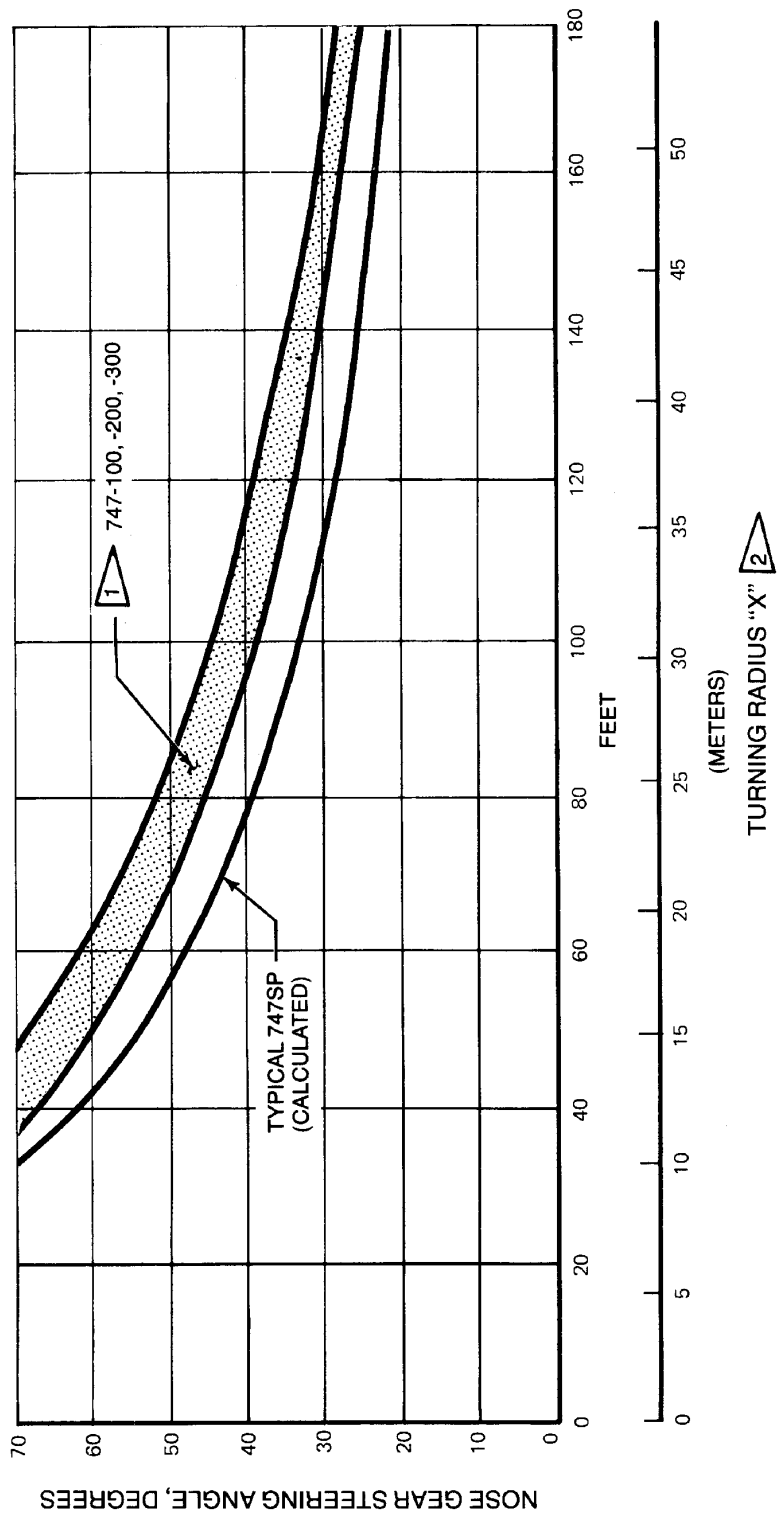

4.2.1 TURNING RADII — WITH BODY GEAR STEERING — SYMMETRICAL THRUST MODEL 747

- NOTES:
- 747-100 AIRPLANE AT 430,000 LB (195,220 KG) (C.G. 27% MAC) AND 600,000 LB (272,400 KG) (C.G. 30% MAC)
 - 747-200 AIRPLANE AT 800,000 LB (363,200 KG) (C.G. 15% MAC)
 - 747SP AIRPLANE AT 600,000 LB (272,400 KG) (C.G. 15% MAC)
 - LOW SPEED 7-25 FT (2.1-7.6 M) PER SEC.
 - NO DIFFERENTIAL BRAKING
 - DRY CONCRETE PAVEMENT
 - 747-300 AIRPLANE AT SAME WEIGHT AND C.G. AS ABOVE -100 OR -200 AIRPLANE

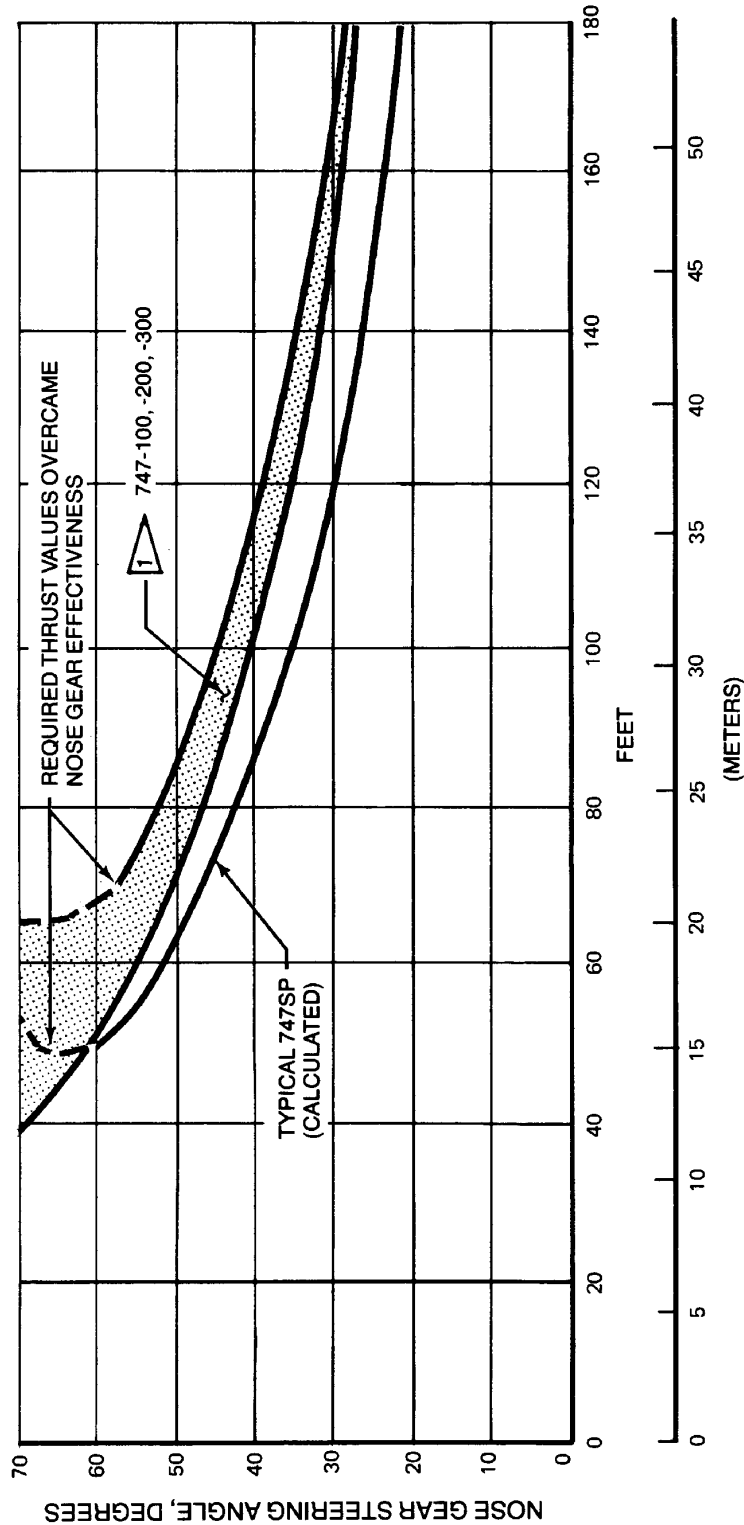

- TURNING RADIUS "X" [2]
- OPERATING RANGE DEPENDENT ON:
- WEIGHT AND C.G. LOCATION
 - PILOT TECHNIQUE
- TURNING RADIUS IS THE DISTANCE BETWEEN AIRPLANE CENTERLINE AND TURN CENTER. [2]

4.2.2 TURNING RADII — BODY GEAR STEERING INOPERATIVE — SYMMETRICAL THRUST MODEL 747

D6-58326

MAY 1984

109

- NOTES:
- 747-100 AIRPLANE AT 430,000 LB (195,220 KG) (C.G. 27% MAC) AND 600,000 LB (272,400 KG) (C.G. 30% MAC)
 - 747-200 AIRPLANE AT 800,000 LB (363,200 KG) (C.G. 15% MAC)
 - 747SP AIRPLANE AT 600,000 LB (272,400 KG) (C.G. 15% MAC)
 - LOW SPEED 7-25 FT (2.1-7.6 M) PER SEC.
 - NO DIFFERENTIAL BRAKING
 - DRY CONCRETE PAVEMENT
 - 747-300 AIRPLANE AT SAME WEIGHT AND C.G. AS ABOVE -100 OR -200 AIRPLANE

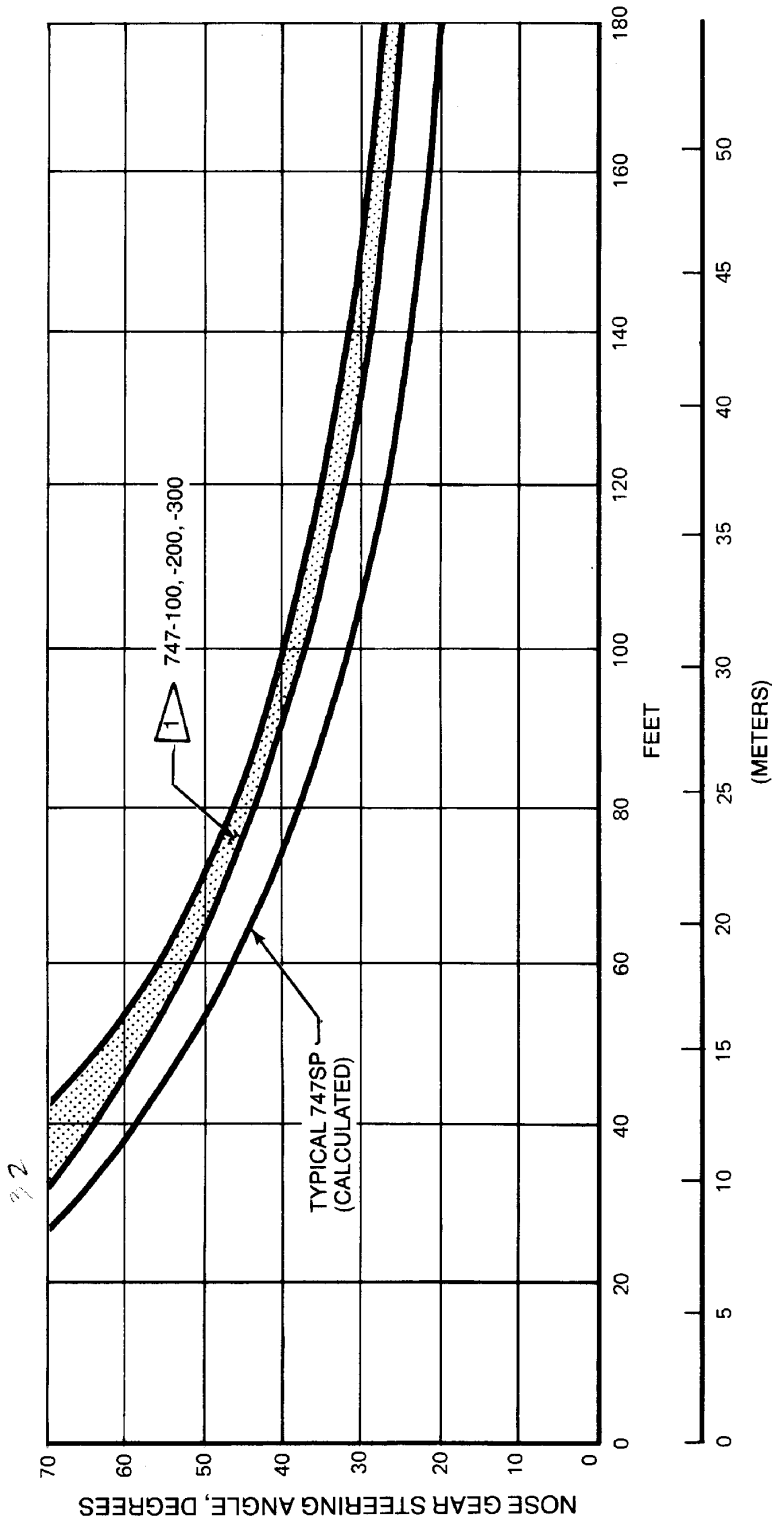

- TURNING RADIUS "X"
- 1 OPERATING RANGE DEPENDENT ON:
 - WEIGHT AND C.G. LOCATION
 - PILOT TECHNIQUE
 - 2 TURNING RADIUS IS THE DISTANCE BETWEEN AIRPLANE CENTERLINE AND TURN CENTER.

4.2.3 TURNING RADII — WITH BODY GEAR STEERING — UNSYMMETRICAL THRUST MODEL 747

- NOTES:
- 747-100 AIRPLANE AT 430,000 LB (195,220 KG) (C.G. 27% MAC) AND 600,000 LB (272,400 KG) (C.G. 30% MAC)
 - 747-200 AIRPLANE AT 800,000 LB (363,200 KG) (C.G. 15% MAC)
 - 747SP AIRPLANE AT 600,000 LB (272,400 KG) (C.G. 15% MAC)
 - LOW SPEED 6-16 FT (1.8-4.9 M) PER SEC.
 - NO DIFFERENTIAL BRAKING
 - DRY CONCRETE PAVEMENT
 - 747-300 AIRPLANE AT SAME WEIGHT AND C.G. AS ABOVE -100 OR -200 AIRPLANE

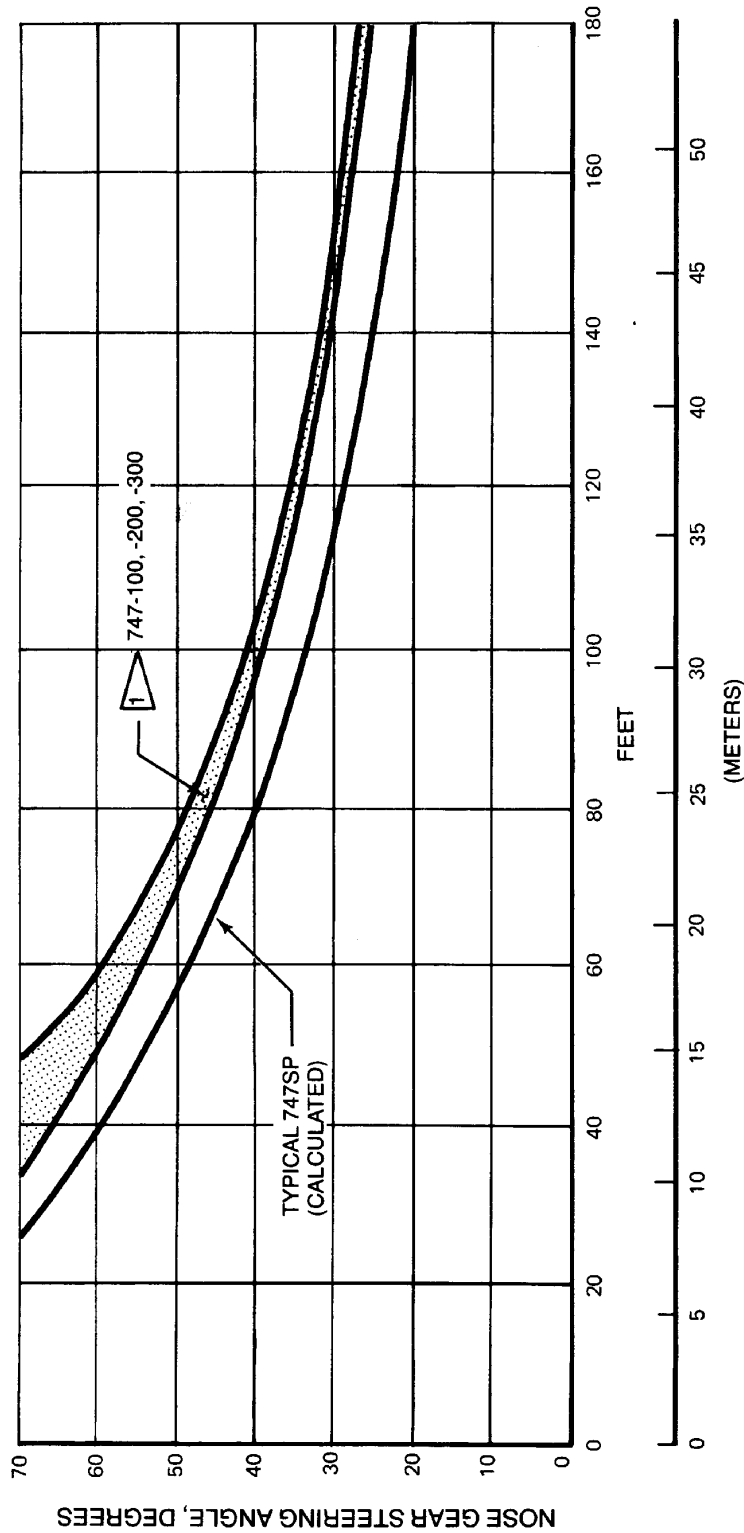

4.2.4 TURNING RADII — BODY GEAR STEERING INOPERATIVE — UNSYMMETRICAL THRUST MODEL 747

- NOTES:
- 747-100 AIRPLANE AT 600,000 LB (272,400 KG) (C.G. 30% MAC)
 - ZERO ENGINE THRUST
 - DRY CONCRETE PAVEMENT
 - TORQUE LINKS CONNECTED
 - 747-300 AIRPLANE AT SAME WEIGHT AND C.G.

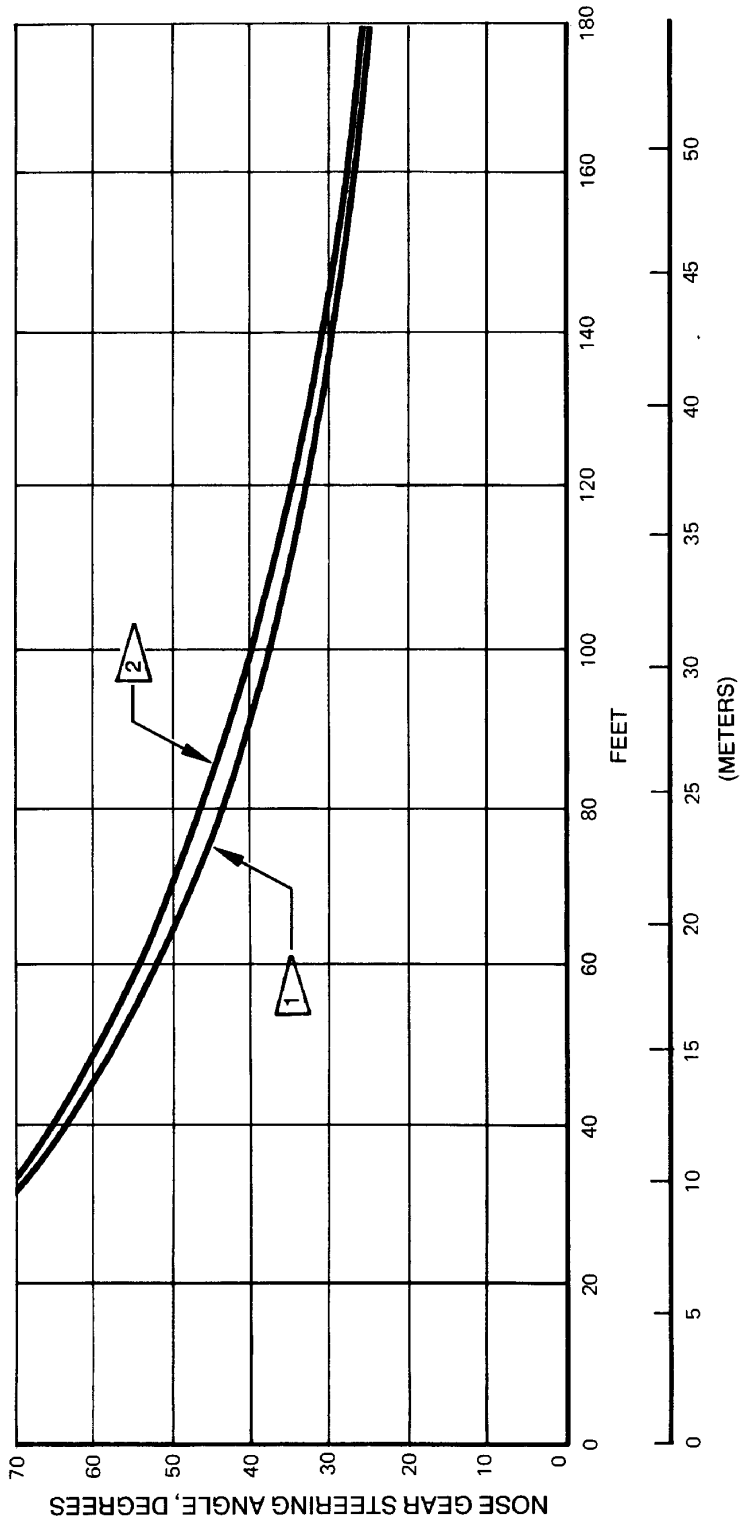

- TURNING RADIUS "X"
- 1 WITH BODY GEAR STEERING — ROLLING DRAWBAR PULL APPROX. 11,100 LB (5,040 KG)
 - 2 BODY GEAR STEERING INOPERATIVE — ROLLING DRAWBAR PULL APPROX. 17,500 LB (7,945 KG)
 - 3 TURNING RADIUS IS THE DISTANCE BETWEEN AIRPLANE CENTERLINE AND TURN CENTER.

4.2.5 TURNING RADII — TOWED MODELS 747-100B, -300

4.2.6 TURNING RADII — TOWED MODELS 747-200, -300

NOTES:

- 747-200 AIRPLANE AT 800,000 LB (363,200 KG) (C.G. 15% MAC)
- ZERO ENGINE THRUST
- DRY CONCRETE PAVEMENT
- TORQUE LINKS CONNECTED
- 747-300 AIRPLANE AT SAME WEIGHT AND C.G.

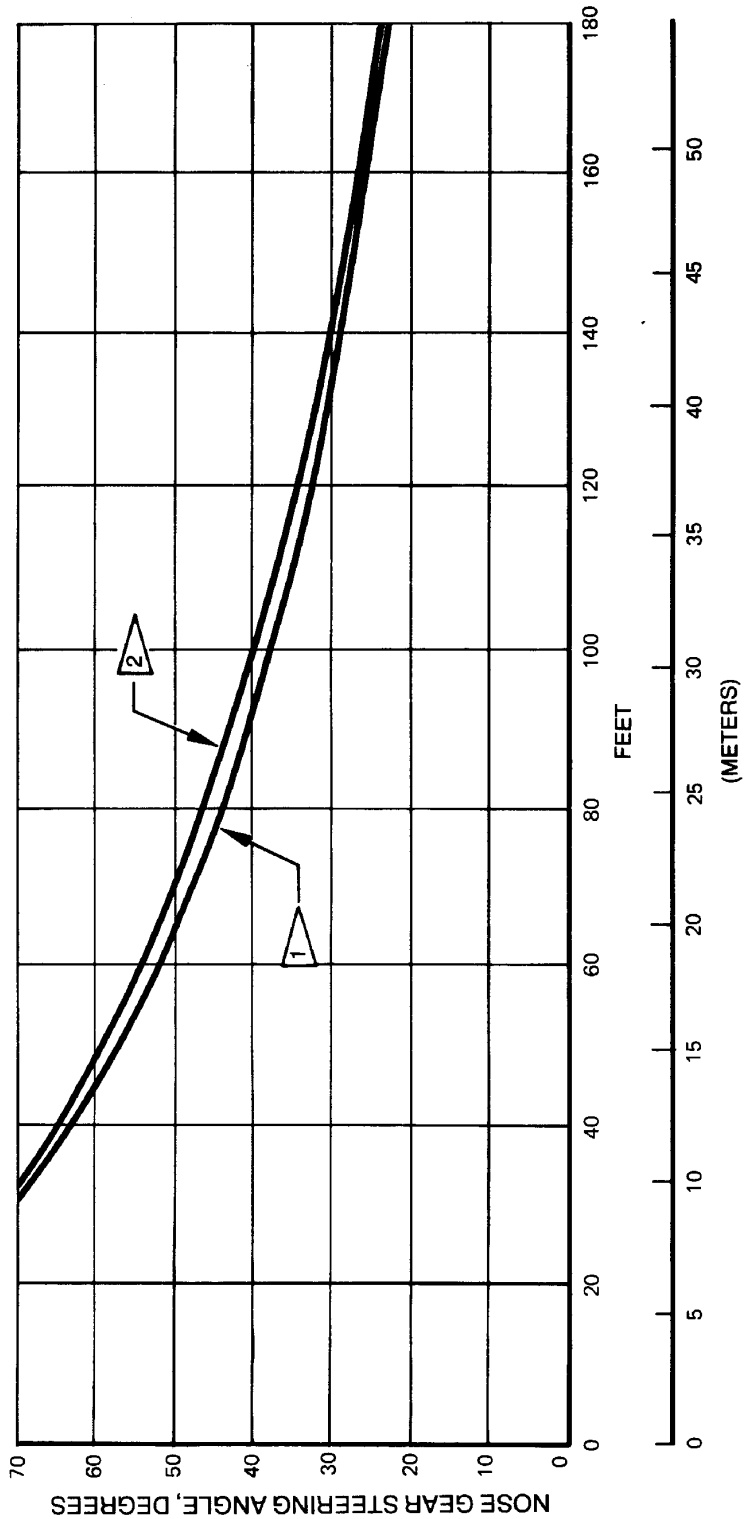

- 1 WITH BODY GEAR STEERING — ROLLING DRAWBAR PULL APPROX. 13,300 LB (6,038 KG)
- 2 BODY GEAR STEERING INOPERATIVE — ROLLING DRAWBAR PULL APPROX. 20,400 LB (9,262 KG)
- 3 TURNING RADIUS IS THE DISTANCE BETWEEN AIRPLANE CENTERLINE AND TURN CENTER.

- NOTES:
- 747SP AIRPLANE AT 600,000 LB (272,400 KG) (C.G. 15% MAC)
 - ZERO ENGINE THRUST
 - DRY CONCRETE PAVEMENT
 - TORQUE LINKS CONNECTED
 - CALCULATED

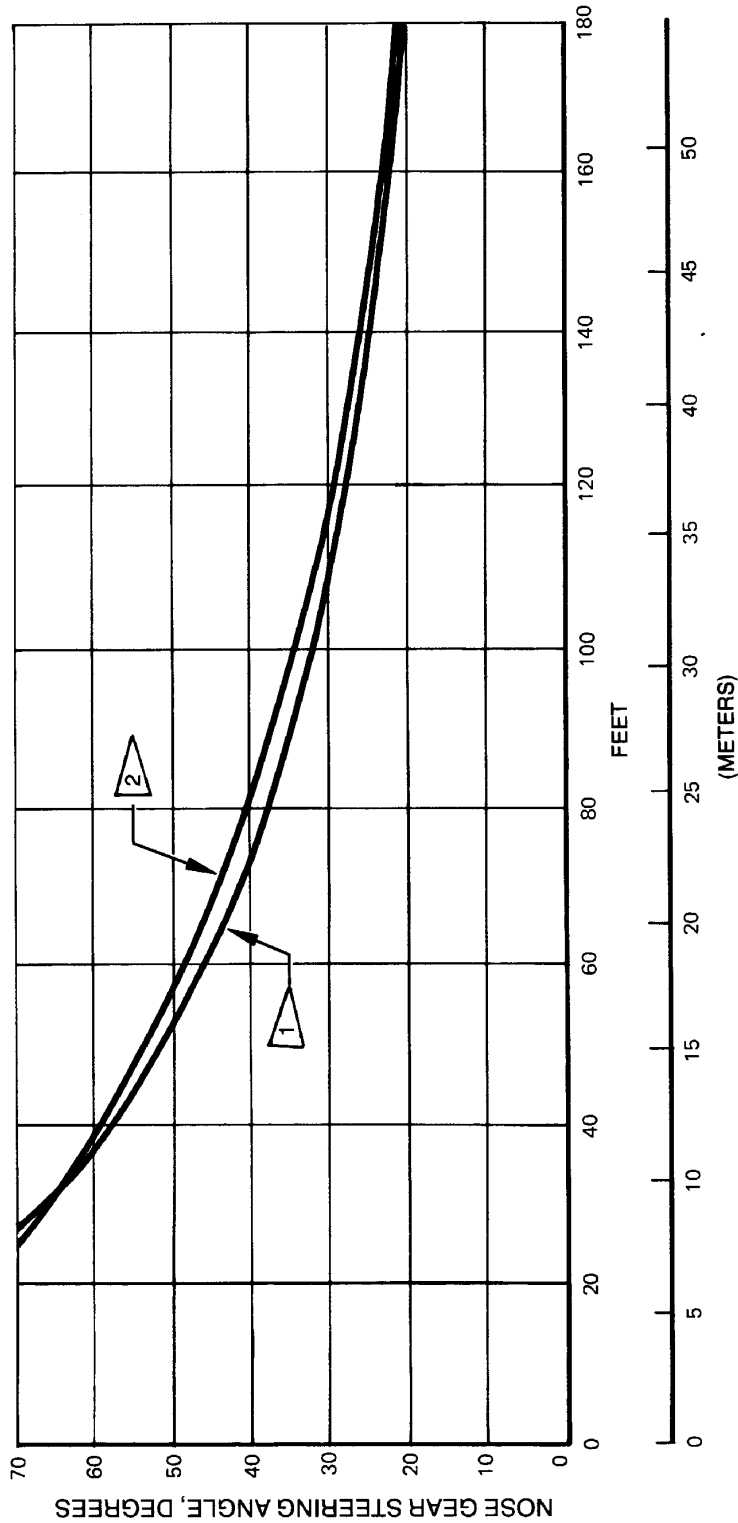

- TURNING RADIUS "X"
- 1 WITH BODY GEAR STEERING — ROLLING DRAWBAR PULL APPROX. 11,700 LB (5,312 KG)
 - 2 BODY GEAR STEERING INOPERATIVE — ROLLING DRAWBAR PULL APPROX. 18,800 LB (8,535 KG)
 - 3 TURNING RADIUS IS THE DISTANCE BETWEEN AIRPLANE CENTERLINE AND TURN CENTER.

4.2.7 TURNING RADII — TOWED MODEL 747SP

NOTE: CONSULT AIRLINE FOR OPERATING PROCEDURES.

X TURN RADIUS (FT)	RADIUS (FT)										z ³ MINIMUM WIDTH FOR 180° TURN (FT)	
	A WING TIP		B ³ NOSE GEAR		C ³ WING GEAR		D TAIL TIP		E NOSE		¹	²
	¹	²	¹	²	¹	²	¹	²	¹	²		
0	113	115	86	81	23	21	125	130	110	105	109	102
20	131	133	89	84	42	41	132	136	111	106	131	125
40	149	151	96	92	62	61	142	146	116	112	158	153
60	168	170	106	102	82	81	153	156	125	121	188	183
80	186	187	118	115	102	101	167	170	136	132	220	216
100	205	206	133	130	121	121	181	184	149	146	254	251
120	225	226	149	146	141	141	197	200	163	160	290	287
140	244	245	166	163	161	161	213	216	178	175	327	324
160	264	265	183	181	181	181	230	232	195	192	364	362

- ¹ BODY GEAR STEERING INOPERATIVE
- ² WITH BODY GEAR STEERING
- ³ MEASURED TO OUTSIDE TIRE FACES
- ⁴ SEE SEC. 4.2

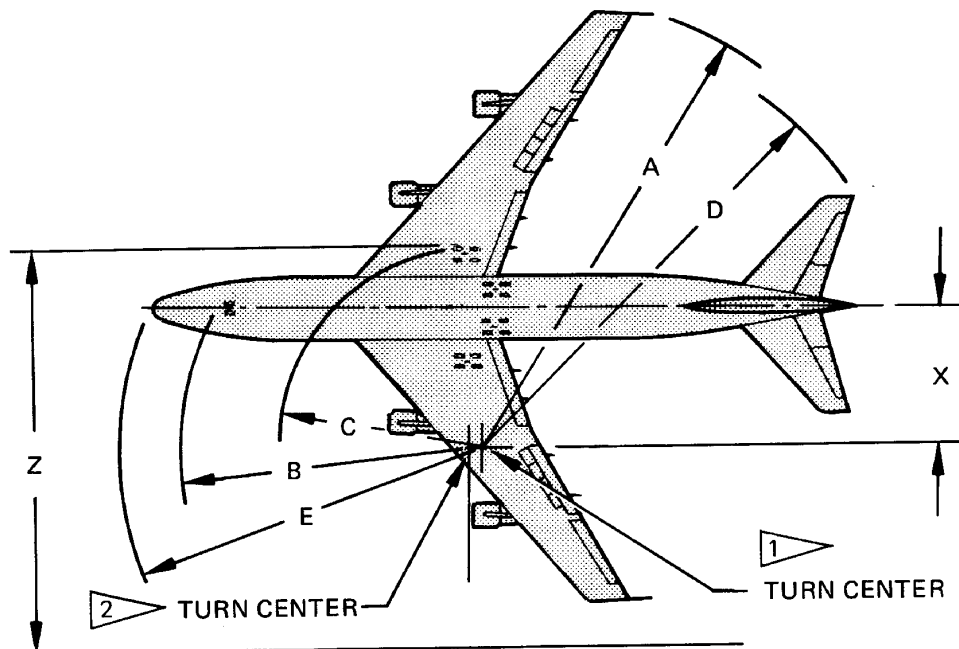

4.3.1 CLEARANCE RADII — ENGLISH UNITS
MODELS 747-100B, -200, -300

NOTE: CONSULT AIRLINE FOR OPERATING PROCEDURES.

X TURN RADIUS METERS	RADIUS (METERS)										Z ³ MINIMUM WIDTH FOR 180° TURN (M)	
	A WING TIP		B ³ NOSE GEAR		C ³ WING GEAR		D TAIL TIP		E NOSE		1	2
	1	2	1	2	1	2	1	2	1	2		
0	34.3	35.0	26.2	24.6	7.5	6.5	38.0	39.6	33.2	31.7	33.7	31.1
5	38.9	39.6	26.7	25.5	12.3	11.7	39.7	41.2	33.5	32.1	38.0	37.2
10	43.5	44.2	28.2	27.0	17.2	16.7	42.0	43.1	34.5	33.3	45.4	43.7
15	48.1	48.8	30.3	29.1	21.8	21.4	44.6	45.8	36.4	35.3	52.1	50.5
20	52.7	53.4	33.2	32.0	26.6	26.3	47.7	48.8	38.7	37.7	59.8	58.3
25	57.4	58.1	36.4	35.5	31.7	31.5	51.4	52.5	41.9	40.9	68.1	67.0
30	62.2	62.7	40.2	39.0	36.3	36.4	55.0	55.9	45.4	44.2	76.5	75.4
35	67.0	67.4	44.2	43.1	41.3	41.3	58.6	59.5	48.7	47.7	85.5	84.4
40	71.8	72.1	48.3	47.4	46.4	46.4	62.5	63.4	52.5	51.6	94.7	93.8
45	76.6	76.8	52.6	52.0	51.5	51.5	67.0	67.8	56.4	55.6	104.1	103.5

- ¹ BODY GEAR STEERING INOPERATIVE
- ² WITH BODY GEAR STEERING
- ³ MEASURED TO OUTSIDE TIRE FACES
- ⁴ SEE SEC. 4.2

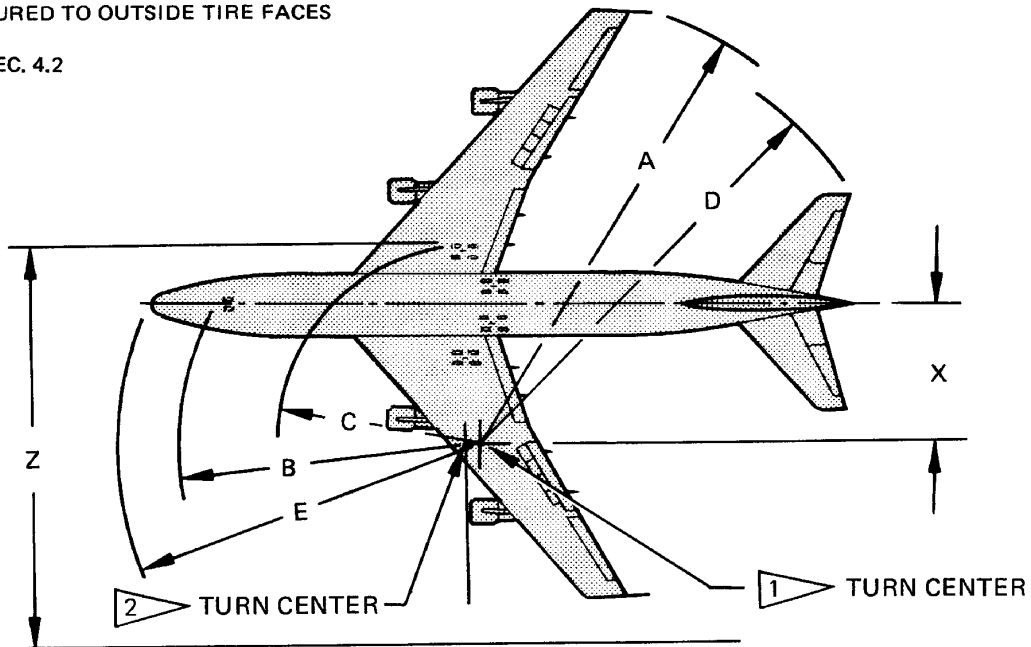

4.3.2 CLEARANCE RADII — METRIC UNITS MODELS 747-100B, -200, -300

NOTE: CONSULT AIRLINE FOR OPERATING PROCEDURES.

X TURN RADIUS (FT)	RADIUS (FT)										z ³ MINIMUM WIDTH FOR 180° TURN (FT)	
	A WING TIP		B ³ NOSE GEAR		C ³ WING GEAR		D TAIL TIP		E NOSE		1	2
	1	2	1	2	1	2	1	2	1	2		
0	113	115	70	65	23	21	97	101	93	88	93	86
20	131	133	74	69	42	41	107	111	96	91	116	110
40	149	151	81	77	62	61	119	122	101	97	143	138
60	168	170	93	90	82	81	134	137	111	107	175	171
80	186	187	108	105	102	101	150	153	123	119	210	206
100	205	206	124	121	121	121	166	169	137	134	245	242
120	225	226	141	138	141	141	184	186	152	149	282	279
140	244	245	158	156	161	161	202	204	168	166	319	317
160	264	265	177	175	181	181	220	222	185	183	358	356

- ¹ BODY GEAR STEERING INOPERATIVE
- ² WITH BODY GEAR STEERING
- ³ MEASURED TO OUTSIDE TIRE FACES
- ⁴ SEE SEC. 4.2

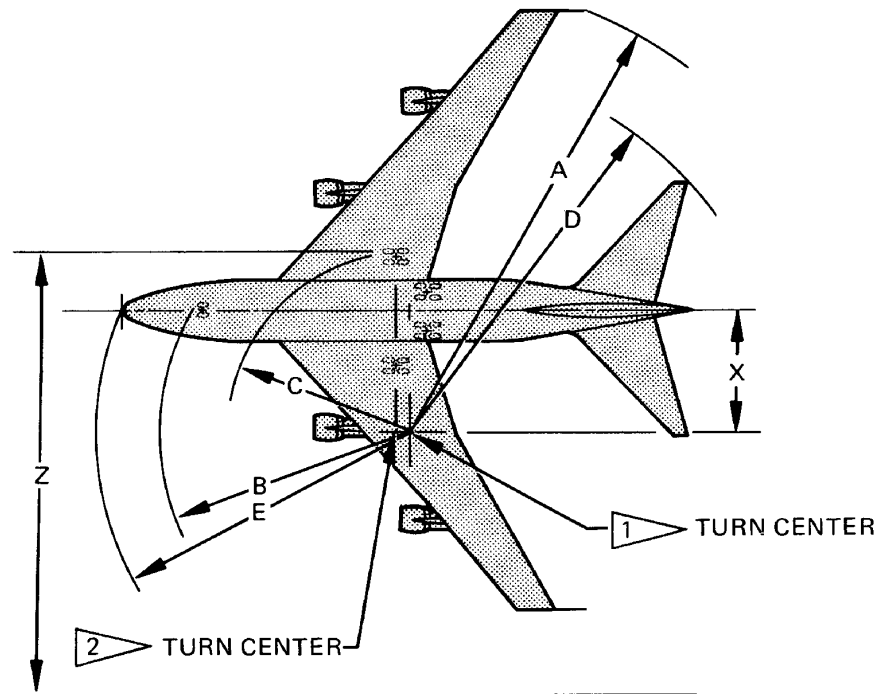

4.3.3 CLEARANCE RADII — ENGLISH UNITS MODEL 747SP

D6-58326

AUGUST 1975

117

NOTE: CONSULT AIRLINE FOR OPERATING PROCEDURES.

X TURN RADIUS METERS	RADIUS (METERS)										z 3 MINIMUM WIDTH FOR 180° TURN (M)	
	A WING TIP		B 3 NOSE GEAR		C 3 WING GEAR		D TAIL TIP		E NOSE		1	2
	1	2	1	2	1	2	1	2	1	2		
0	34.3	35.0	21.3	19.6	7.5	6.5	29.3	30.7	28.2	26.6	28.8	26.1
5	38.9	39.6	22.0	20.7	12.3	11.7	31.8	33.0	28.8	27.2	34.3	32.4
10	43.5	44.2	23.7	22.5	17.2	16.7	35.0	35.9	30.2	28.6	40.9	39.2
15	48.1	48.8	26.2	25.1	21.8	21.4	38.3	39.2	32.2	30.8	48.0	46.5
20	52.7	53.4	29.3	28.3	26.6	26.3	42.1	42.9	34.7	33.6	55.9	54.6
25	57.4	58.1	33.2	32.4	31.7	31.5	46.2	47.0	37.7	36.7	64.9	63.9
30	62.2	62.7	37.1	36.2	36.3	36.4	50.2	51.0	41.4	40.5	73.4	72.6
35	67.0	67.4	41.5	40.6	41.3	41.3	54.4	55.2	45.2	44.3	82.8	81.9
40	71.8	72.1	45.9	45.2	46.4	46.4	58.8	59.6	49.0	48.3	92.3	91.6
45	76.6	76.8	50.3	49.6	51.5	51.5	63.3	64.0	53.2	52.5	101.8	101.1

- 1 BODY GEAR STEERING INOPERATIVE
- 2 WITH BODY GEAR STEERING
- 3 MEASURED TO OUTSIDE TIRE FACES
- 4 SEE SEC. 4.2

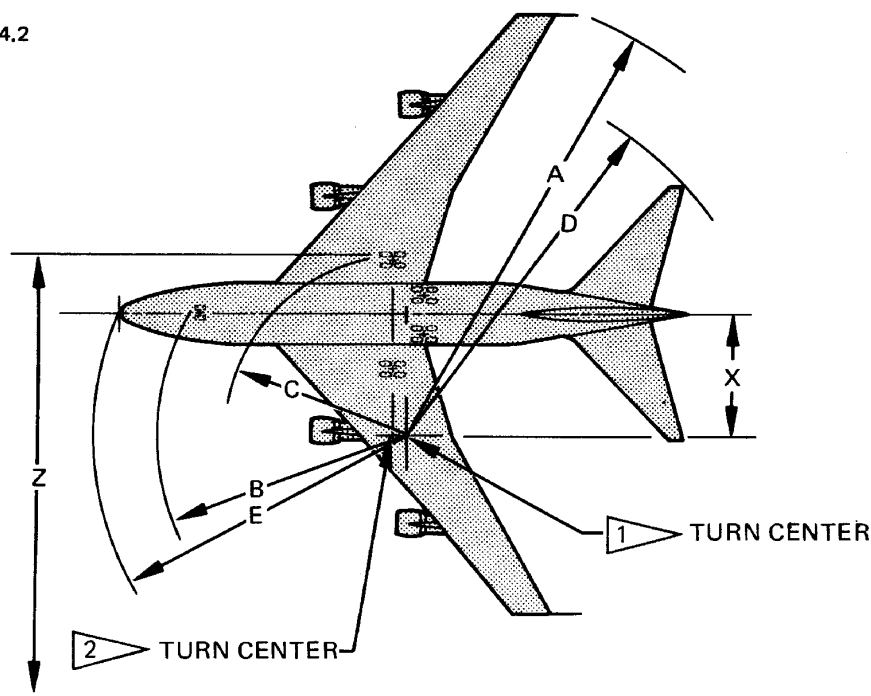

4.3.4 CLEARANCE RADII — METRIC UNITS MODEL 747SP

NOT TO SCALE

NOT TO BE USED FOR LANDING APPROACH VISIBILITY

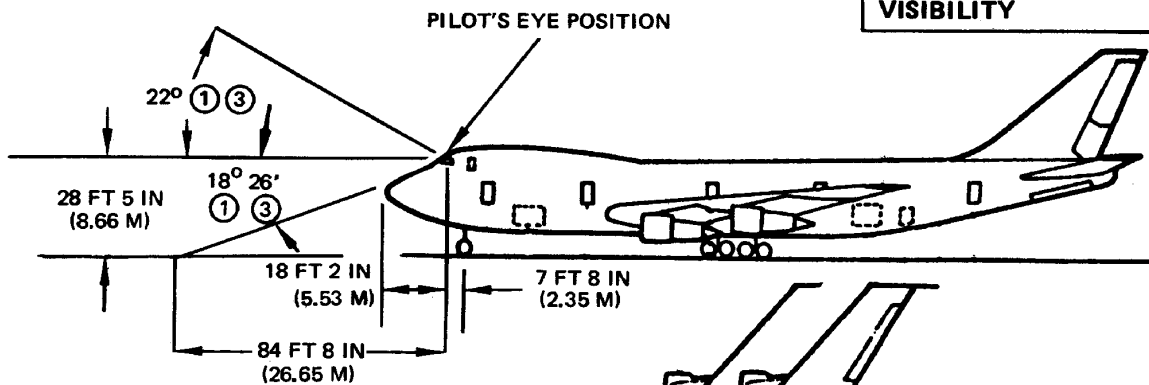

VISUAL ANGLES IN VERTICAL PLANE THROUGH PILOT'S EYE POSITION

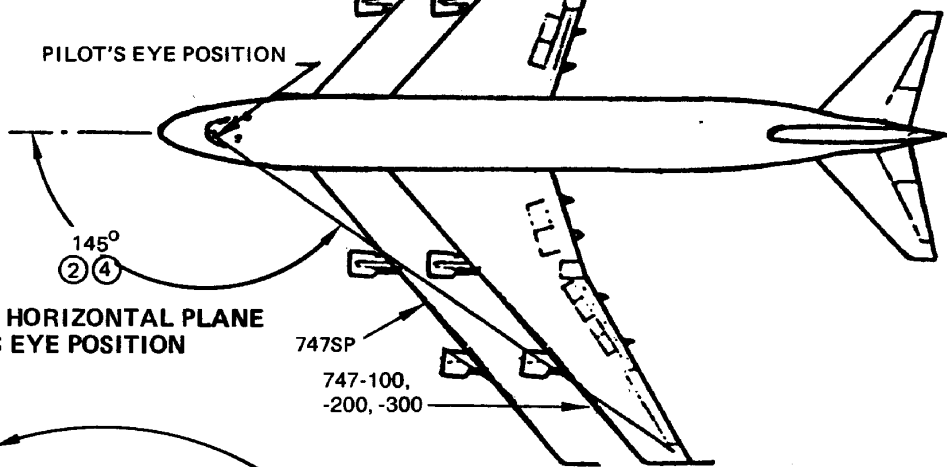

VISUAL ANGLE IN HORIZONTAL PLANE THROUGH PILOT'S EYE POSITION

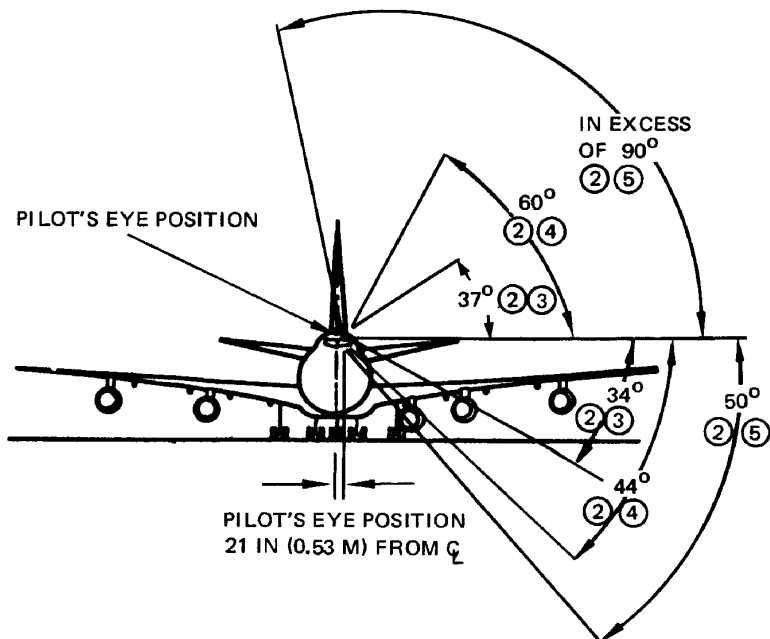

VISUAL ANGLES IN PLANE PERPENDICULAR TO LONGITUDINAL AXIS THROUGH PILOT'S EYE POSITION

NOTES:

- ① VISUAL ANGLES THROUGH WINDSHIELD.
- ② VISUAL ANGLES THROUGH SIDE WINDOW.
- ③ VISUAL ANGLES FROM NORMAL POSITION.
- ④ VISUAL ANGLES FROM ALERT POSITION, HEAD MOVED OUTBOARD 5 IN. (0.127 M)
- ⑤ VISUAL ANGLES WITH HEAD MOVED 7 IN. (0.178M) OUTBOARD
- ⑥ HEAD IS ROTATED ABOUT A POINT 3 IN. (0.084-M) AFT OF PILOT'S EYE POSITION

**4.4 VISIBILITY FROM COCKPIT IN STATIC POSITION
MODEL 747**

4.5 Runway and Taxiway Turn Paths

This section shows the projected paths of the nose gear and main gear tires at runway and taxiway intersections. Different configurations are shown to address the various turning techniques and recommended practices. As noted, various States may require different clearances; therefore it is imperative that the using airline or the airport authority be contacted for details.

This section also shows approximate pavement clearances at intersections with 100-ft (30.48-m) fillets. Modified fillets are shown where there is obviously not enough clearance between the edge of the pavement and the outer edge of the main or nose gear tires. The size of the fillets depends upon prevailing clearance requirements.

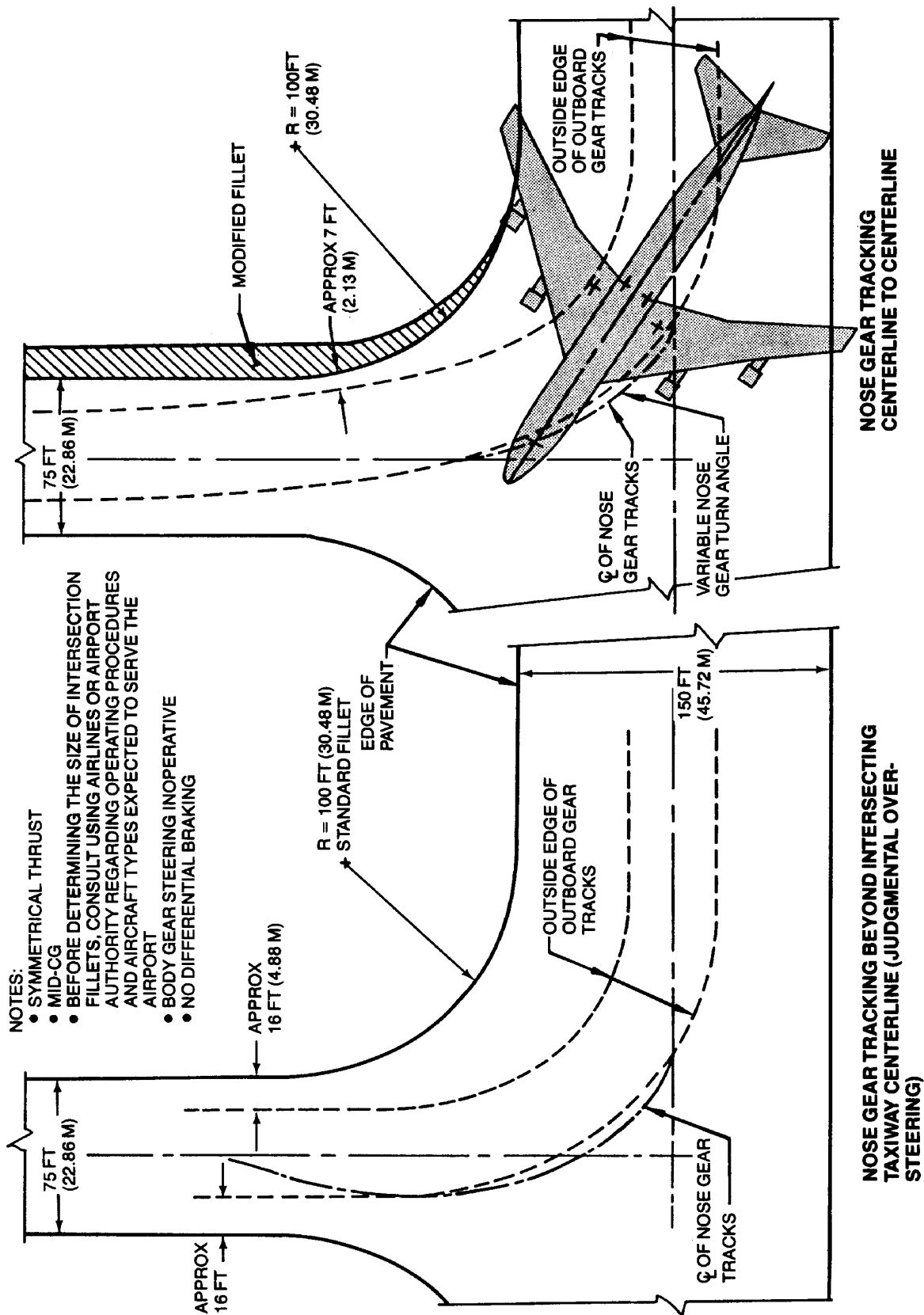

**4.5.1 RUNWAY AND TAXIWAY TURN PATHS — RUNWAY-TO-TAXIWAY, 90 DEGREES
MODELS 747-100B, -200, -300**

D6-58326

Not Subject to EAR or ITAR.

Copyright © 2023 Boeing. All Rights Reserved.

MAY 1984

121

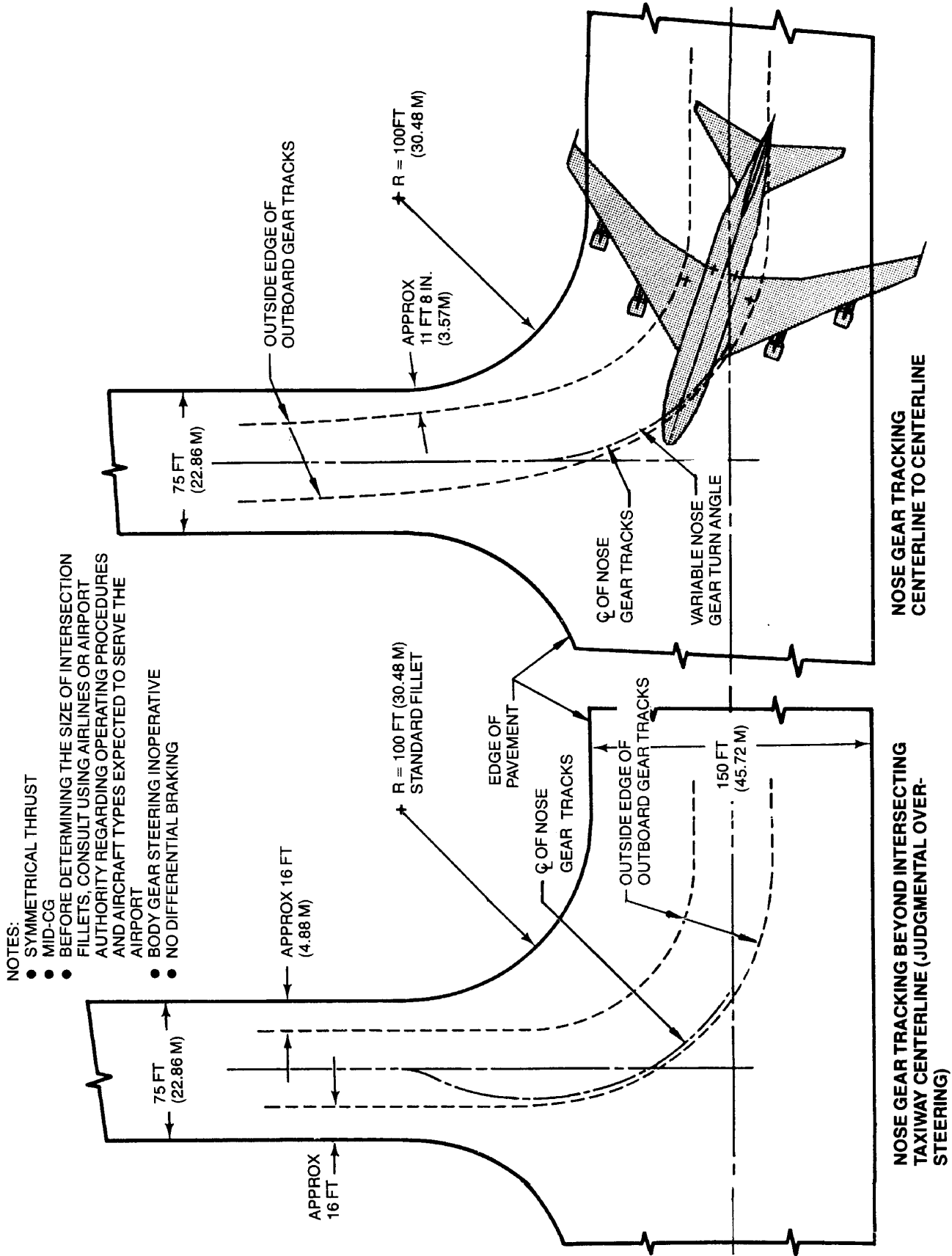

- NOTES:
- SYMMETRICAL THRUST
 - MID-CG
 - BEFORE DETERMINING THE SIZE OF INTERSECTION FILLETS, CONSULT USING AIRLINES OR AIRPORT AUTHORITY REGARDING OPERATING PROCEDURES AND AIRCRAFT TYPES EXPECTED TO SERVE THE AIRPORT
 - BODY GEAR STEERING INOPERATIVE
 - NO DIFFERENTIAL BRAKING

4.5.2 RUNWAY AND TAXIWAY TURN PATHS — RUNWAY-TO-TAXIWAY, 90 DEGREES MODEL 747SP

- NOTES:
- SYMMETRICAL THRUST
 - MID-CG
 - NOSE GEAR TURN ANGLE VARIES ALONG THE TURN
 - BEFORE DETERMINING THE SIZE OF INTERSECTION FILLETS, CONSULT USING AIRLINES OR AIRPORT AUTHORITY REGARDING OPERATING PROCEDURES AND AIRCRAFT TYPES EXPECTED TO SERVE THE AIRPORT

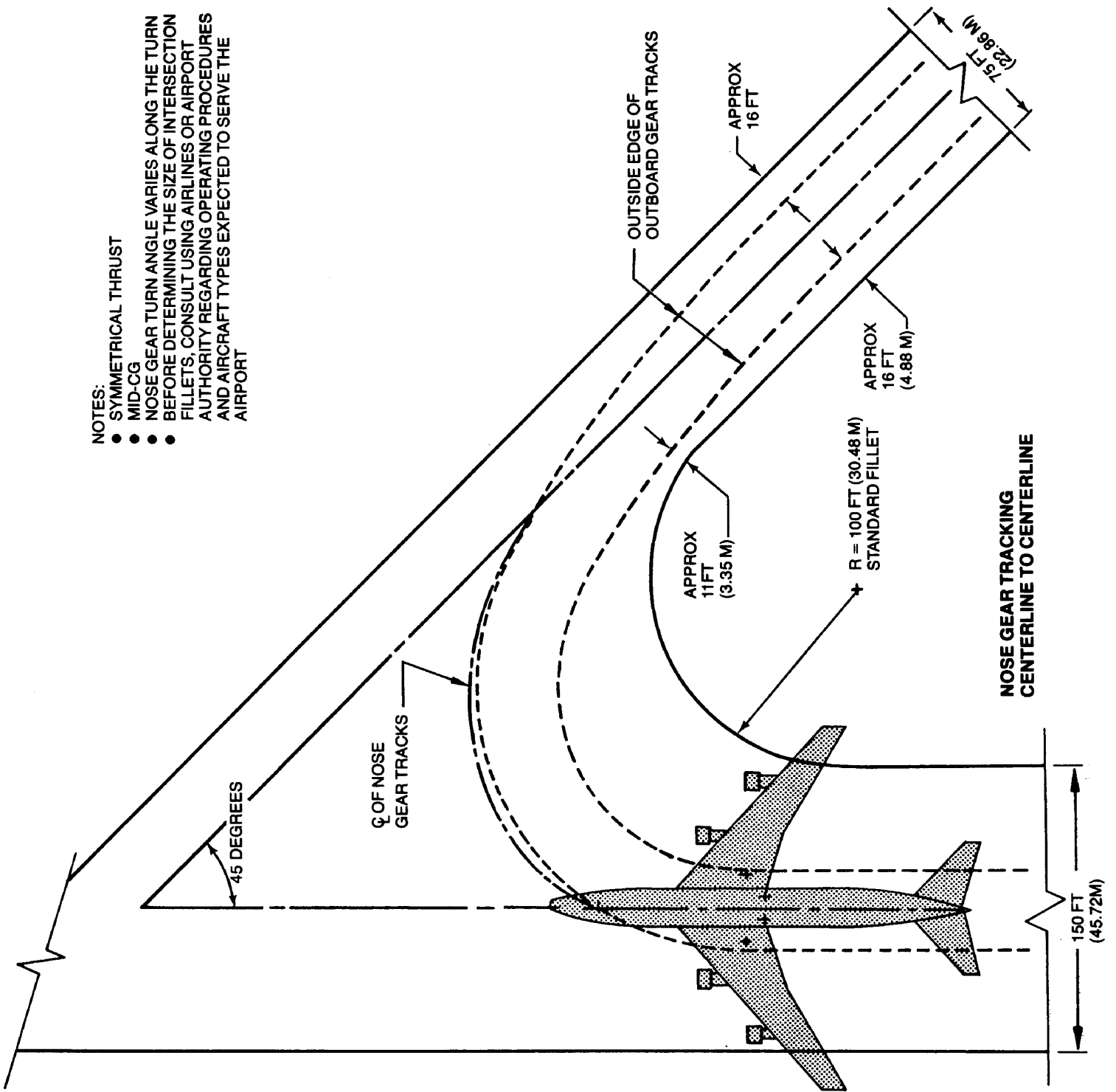

4.5.3 RUNWAY AND TAXIWAY TURN PATHS — RUNWAY-TO-TAXIWAY, MORE THAN 90 DEGREES
MODELS 747-100B, -200, -300

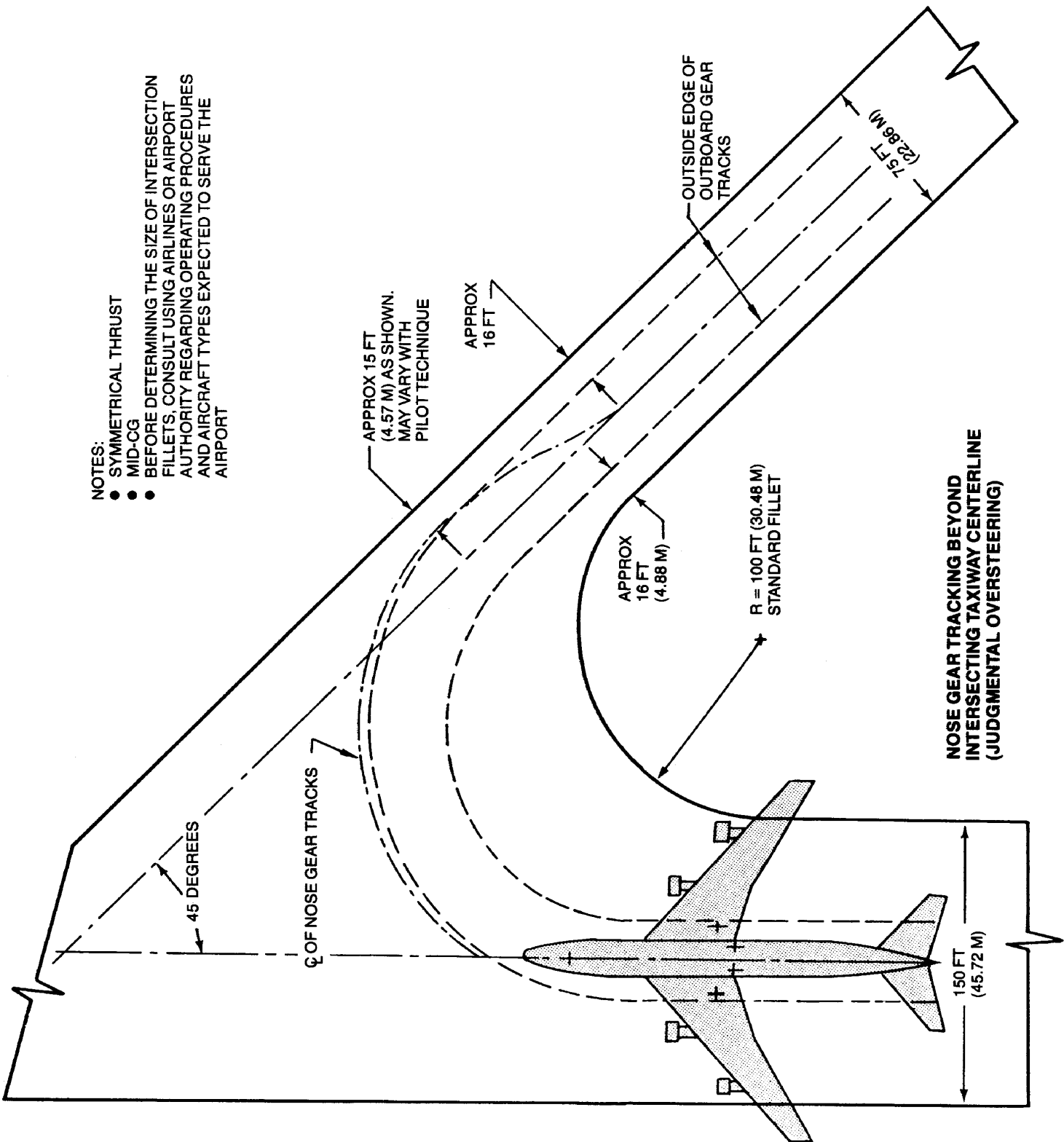

- NOTES:
- SYMMETRICAL THRUST
 - MID-CG
 - BEFORE DETERMINING THE SIZE OF INTERSECTION FILLETS, CONSULT USING AIRLINES OR AIRPORT AUTHORITY REGARDING OPERATING PROCEDURES AND AIRCRAFT TYPES EXPECTED TO SERVE THE AIRPORT

**4.5.4 RUNWAY AND TAXIWAY TURN PATHS — RUNWAY-TO-TAXIWAY, MORE THAN 90 DEGREES
MODELS 747-100B, -200, -300**

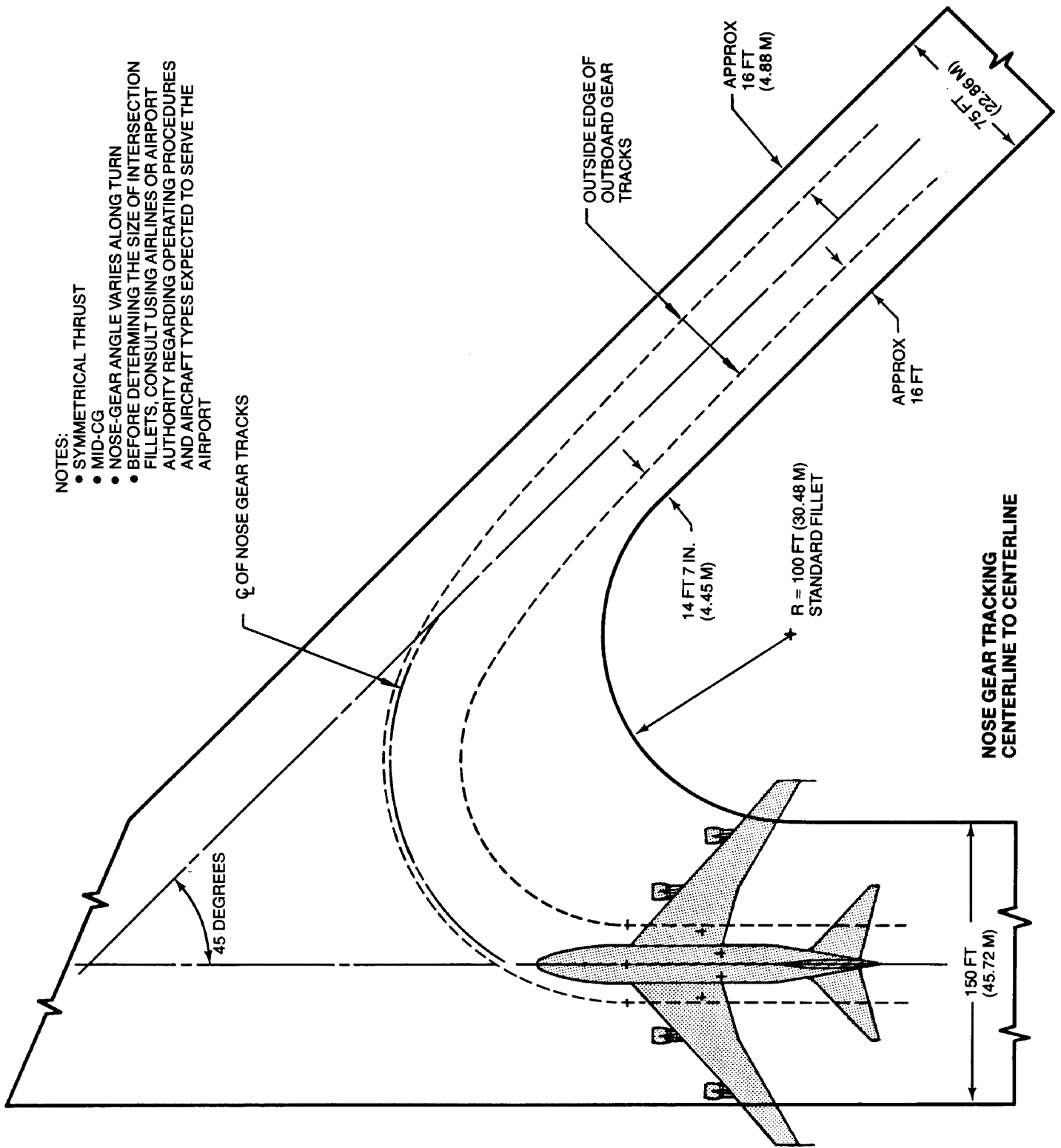

**4.5.5 RUNWAY AND TAXIWAY TURN PATHS — RUNWAY-TO-TAXIWAY, MORE THAN 90 DEGREES
MODEL 747SP**

D6-58326

Not Subject to EAR or ITAR.

Copyright © 2023 Boeing. All Rights Reserved.

APRIL 1981

125

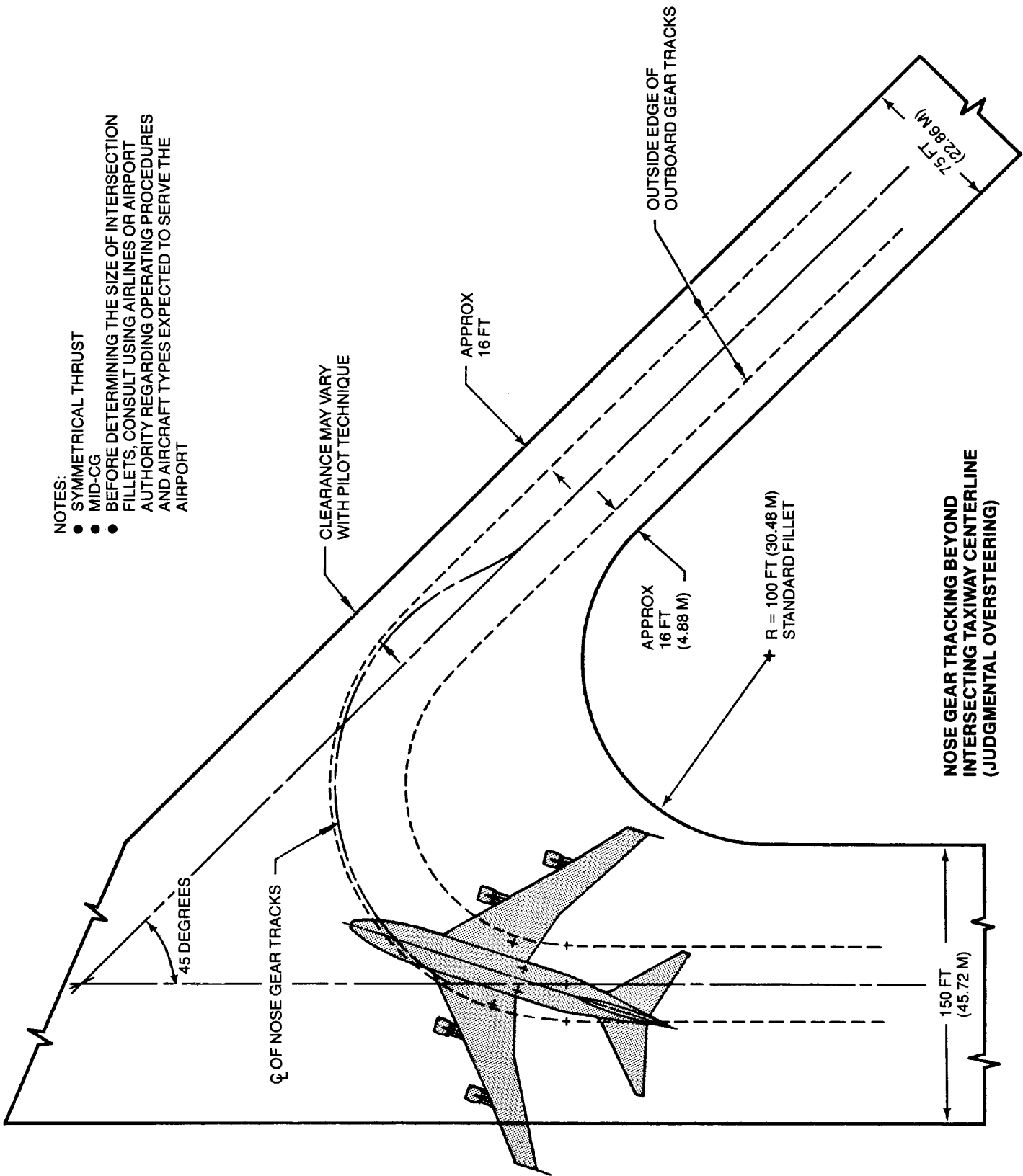

**4.5.6 RUNWAY AND TAXIWAY TURN PATHS — RUNWAY-TO-TAXIWAY, MORE THAN 90 DEGREES
MODEL 747SP**

- NOTES:
- SYMMETRICAL THRUST
 - MID-CG
 - BEFORE DETERMINING THE SIZE OF INTERSECTION FILLETS, CONSULT USING AIRLINES OR AIRPORT AUTHORITY REGARDING OPERATING PROCEDURES AND AIRCRAFT TYPES EXPECTED TO SERVE THE AIRPORT
 - BODY GEAR STEERING INOPERATIVE
 - NO DIFFERENTIAL BRAKING

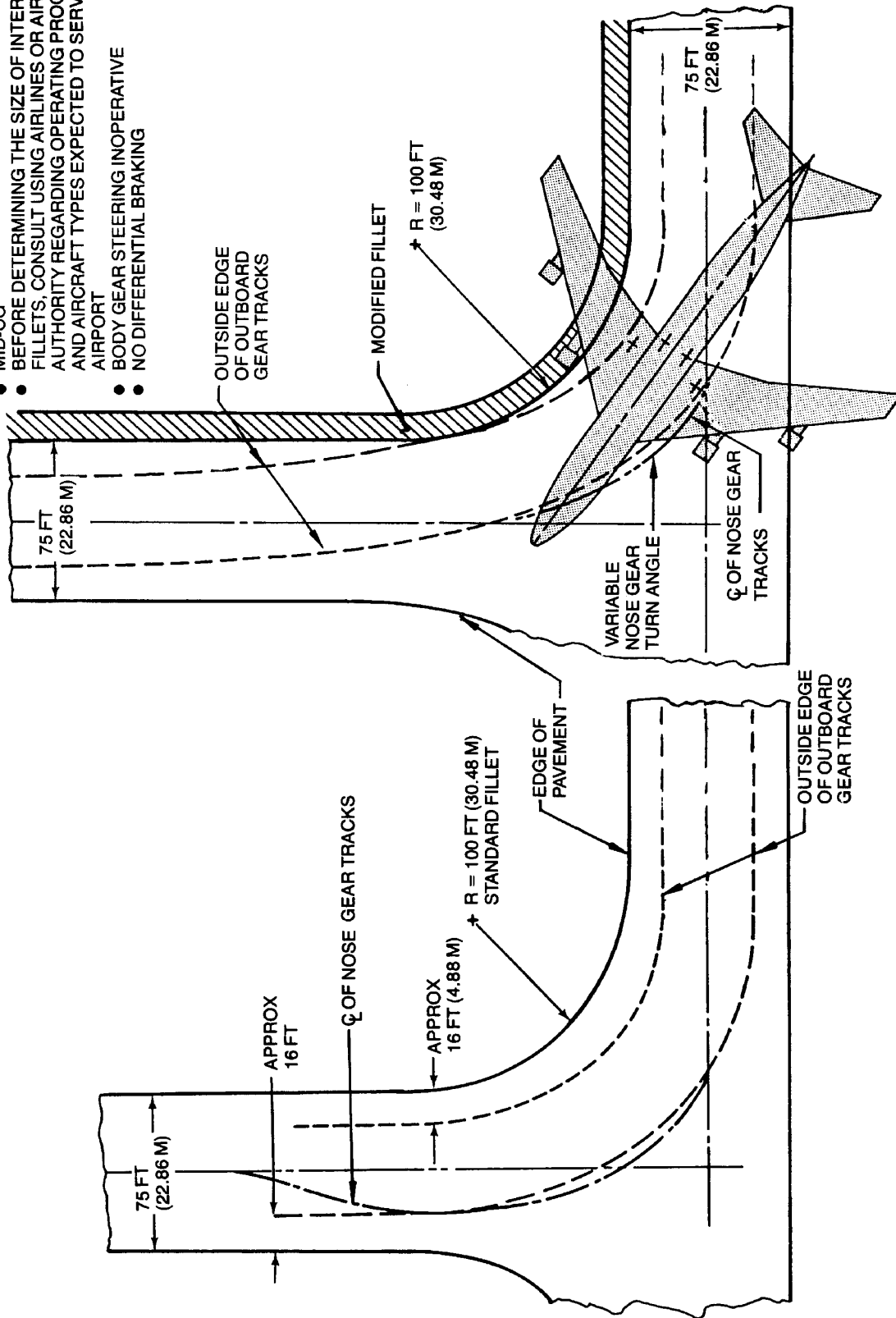

4.5.7 RUNWAY AND TAXIWAY TURN PATHS — TAXIWAY-TO-TAXIWAY
 MODELS 747-100B, -200, -300

NOTES:

- SYMMETRICAL THRUST
- MID-CG
- BEFORE DETERMINING THE SIZE OF INTERSECTION FILLETS, CONSULT USING AIRLINES OR AIRPORT AUTHORITY REGARDING OPERATING PROCEDURES AND AIRCRAFT TYPES EXPECTED TO SERVE THE AIRPORT
- BODY GEAR STEERING INOPERATIVE
- NO DIFFERENTIAL BRAKING

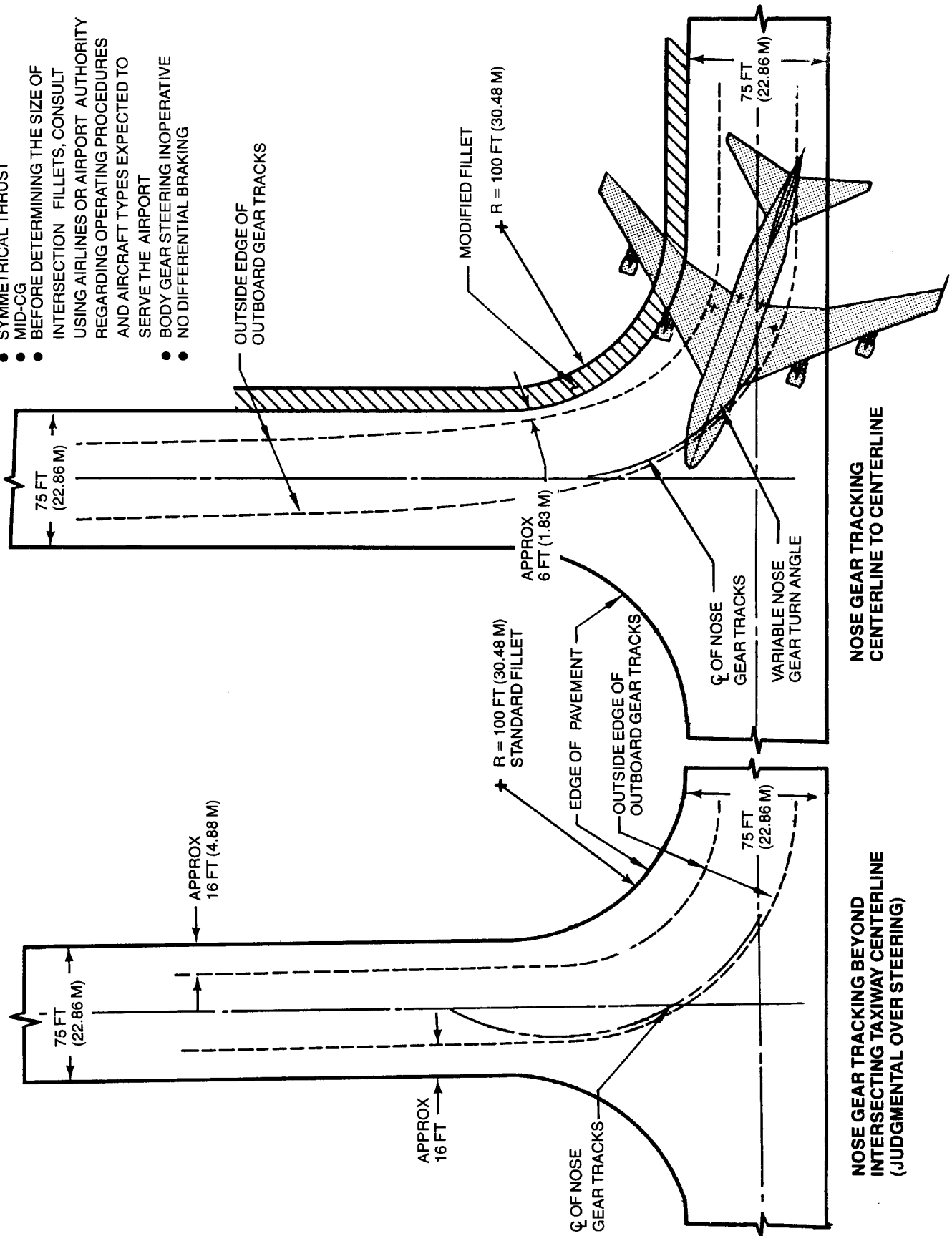

**4.5.8 RUNWAY AND TAXIWAY TURN PATHS — TAXIWAY-TO-TAXIWAY
MODEL 747SP**

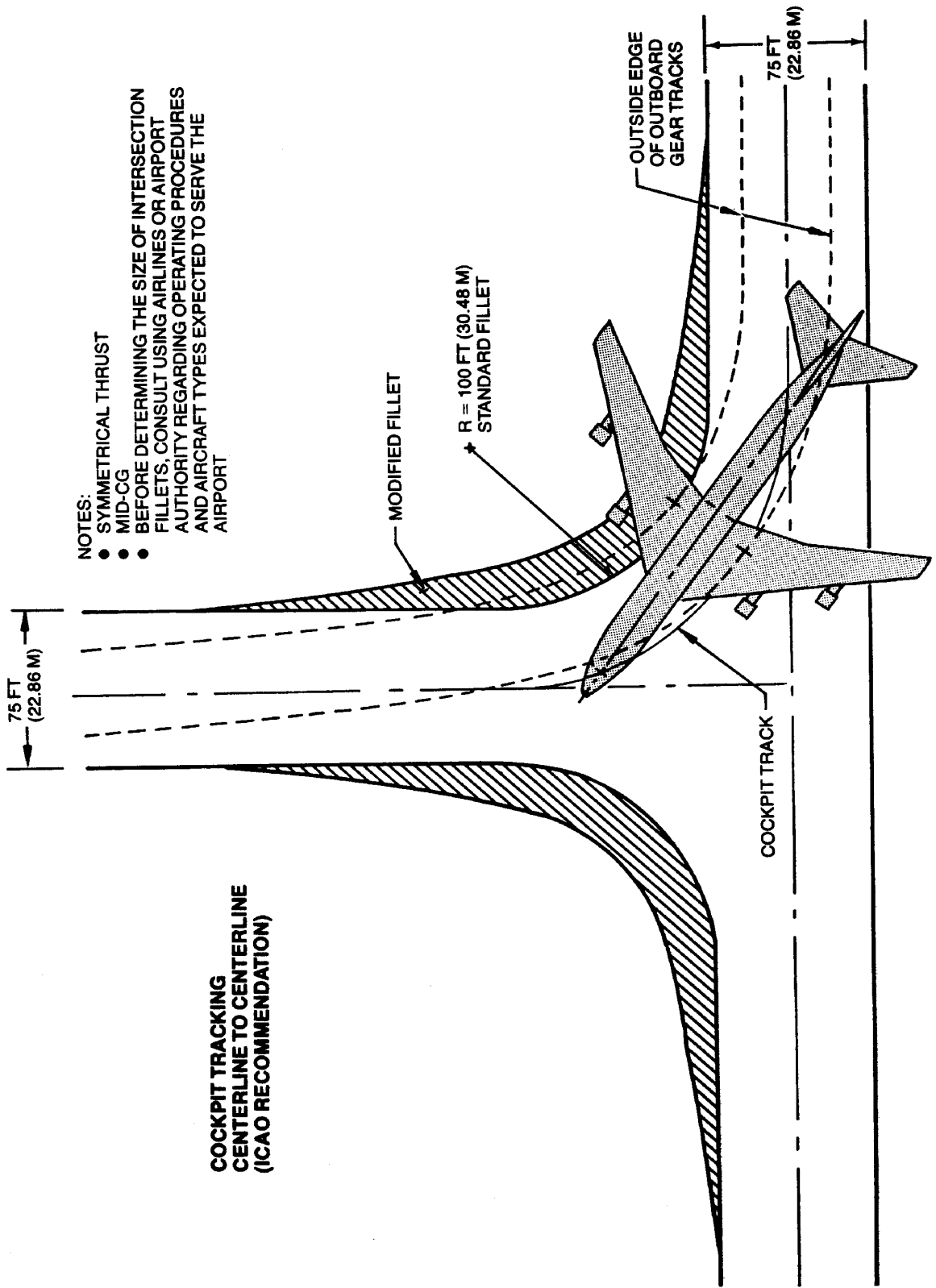

- NOTES:
- SYMMETRICAL THRUST
 - MID-CG
 - BEFORE DETERMINING THE SIZE OF INTERSECTION FILLETS, CONSULT USING AIRLINES OR AIRPORT AUTHORITY REGARDING OPERATING PROCEDURES AND AIRCRAFT TYPES EXPECTED TO SERVE THE AIRPORT

**4.5.9 RUNWAY AND TAXIWAY TURN PATHS — TAXIWAY-TO-TAXIWAY, ICAO RECOMMENDATION
MODELS 747-100B, -200, -300**

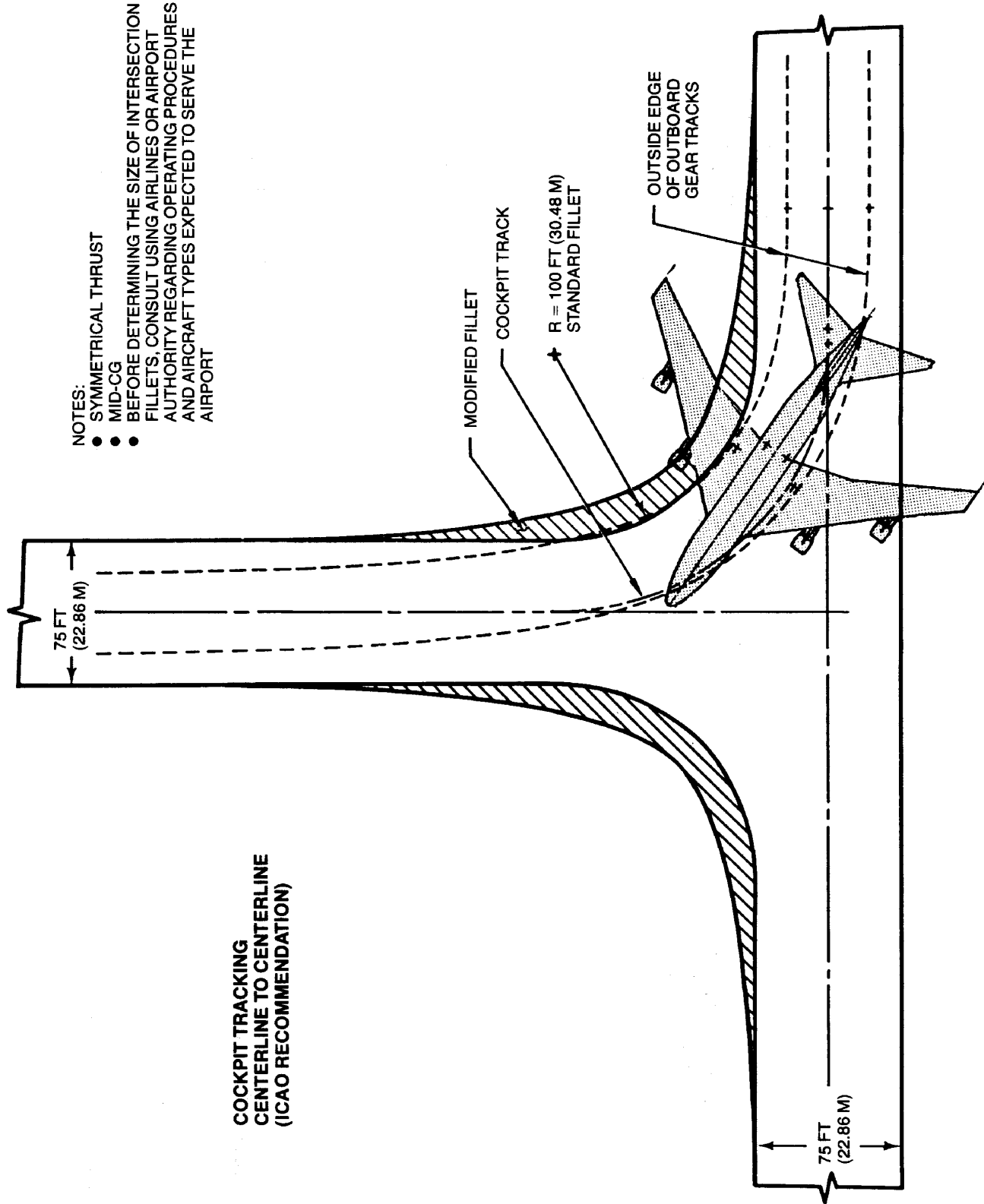

- NOTES:
- SYMMETRICAL THRUST
 - MID-CG
 - BEFORE DETERMINING THE SIZE OF INTERSECTION FILLETS, CONSULT USING AIRLINES OR AIRPORT AUTHORITY REGARDING OPERATING PROCEDURES AND AIRCRAFT TYPES EXPECTED TO SERVE THE AIRPORT

COCKPIT TRACKING
CENTERLINE TO CENTERLINE
(ICAO RECOMMENDATION)

4.5.10 RUNWAY AND TAXIWAY TURN PATHS — TAXIWAY-TO-TAXIWAY, ICAO RECOMMENDATION MODEL 747SP

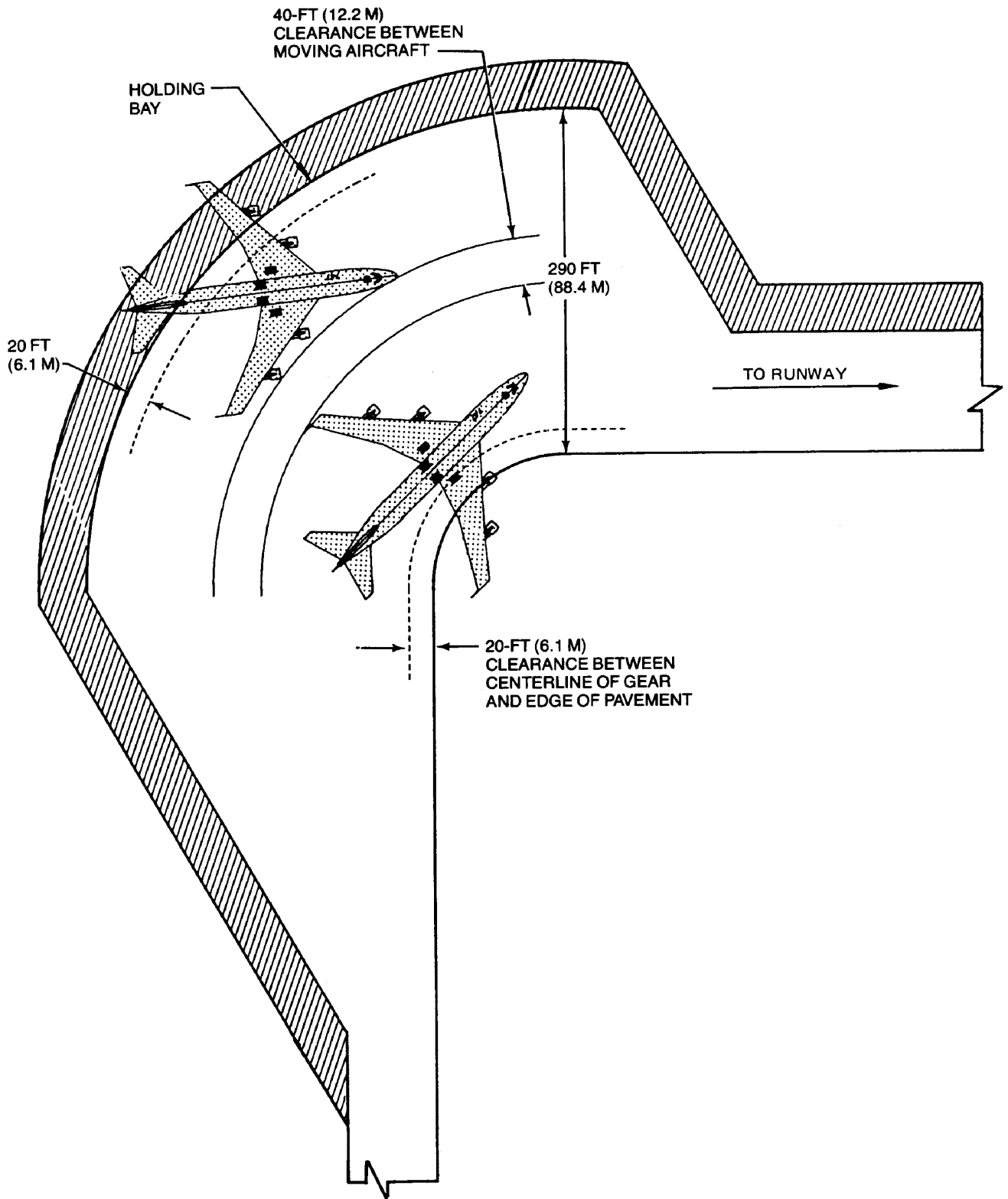

4.6 RUNWAY HOLDING BAY
MODEL 747

D6-58326

APRIL 1981

131

THIS PAGE INTENTIONALLY LEFT BLANK

- 5.0 **TERMINAL SERVICING****
- 5.1 **Airplane Servicing Arrangement (Typical Turnaround)****
- 5.2 **Terminal Operations (Turnaround Station)****
- 5.3 **Terminal Operations (En Route Station)****
- 5.4 **Ground Service Connections****
- 5.5 **Engine Starting Pneumatic Requirements****
- 5.6 **Ground Pneumatic Power Requirements****
- 5.7 **Conditioned Airflow Requirements****
- 5.8 **Ground Towing Requirements****

5.0 TERMINAL SERVICING

During turnaround at the terminal, certain services must be performed on the aircraft, usually within a given time to meet flight schedules. This section shows service vehicle arrangements, schedules, locations of service points, and typical service requirements. The data presented herein reflect ideal conditions for a single airplane. Service requirements may vary according to airplane condition and airline procedure.

Section 5.1 shows typical arrangements of ground support during turnaround. As noted, if the auxiliary power unit (APU) is used the electrical, air start, and air-conditioning service vehicles would not be required. Passenger loading bridges or portable passenger stairs could be used to load or unload passengers.

Sections 5.2 and 5.3 show typical service times at the terminal. These charts give typical schedules for performing service on the airplane within a given time. Service times could be rearranged to suit availability of personnel, airplane configuration, and degree of service required.

Section 5.4 shows the locations of ground service connections in graphic and in tabular forms. Typical capacities and service requirements are shown in the tables. Services with requirements that vary with conditions are described in subsequent sections.

Section 5.5 shows typical sea-level, standard-day, pneumatic requirements for starting various engines with different starters. Examples are illustrated on the graphs.

Section 5.6 shows pneumatic requirements for heating and cooling (air conditioning) using high-pressure air to run the air-cycle machine. The curves show airflow requirements to heat or cool the airplane within a given time and ambient conditions. Examples are illustrated on the graphs. Maximum allowable pressure and temperature for air cycle machine operation are 60 psia and 450°F, respectively.

Section 5.7 shows pneumatic requirements for heating and cooling the airplane, using low-pressure conditioned air. This conditioned air is supplied through an 8-in. ground air connection (GAC) directly to the passenger cabin, bypassing the air-cycle machines.

Section 5.8 shows ground towing requirements for various conditions. Examples are illustrated on the graphs.

NOTE:
 • UNDER NORMAL CONDITIONS, EXTERNAL ELECTRICAL POWER, AIR START,
 AND AIR CONDITIONING ARE NOT REQUIRED WHEN THE AUXILIARY POWER UNIT IS USED.

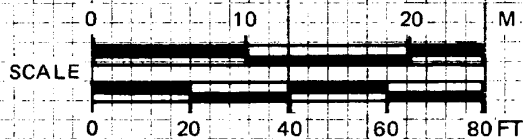
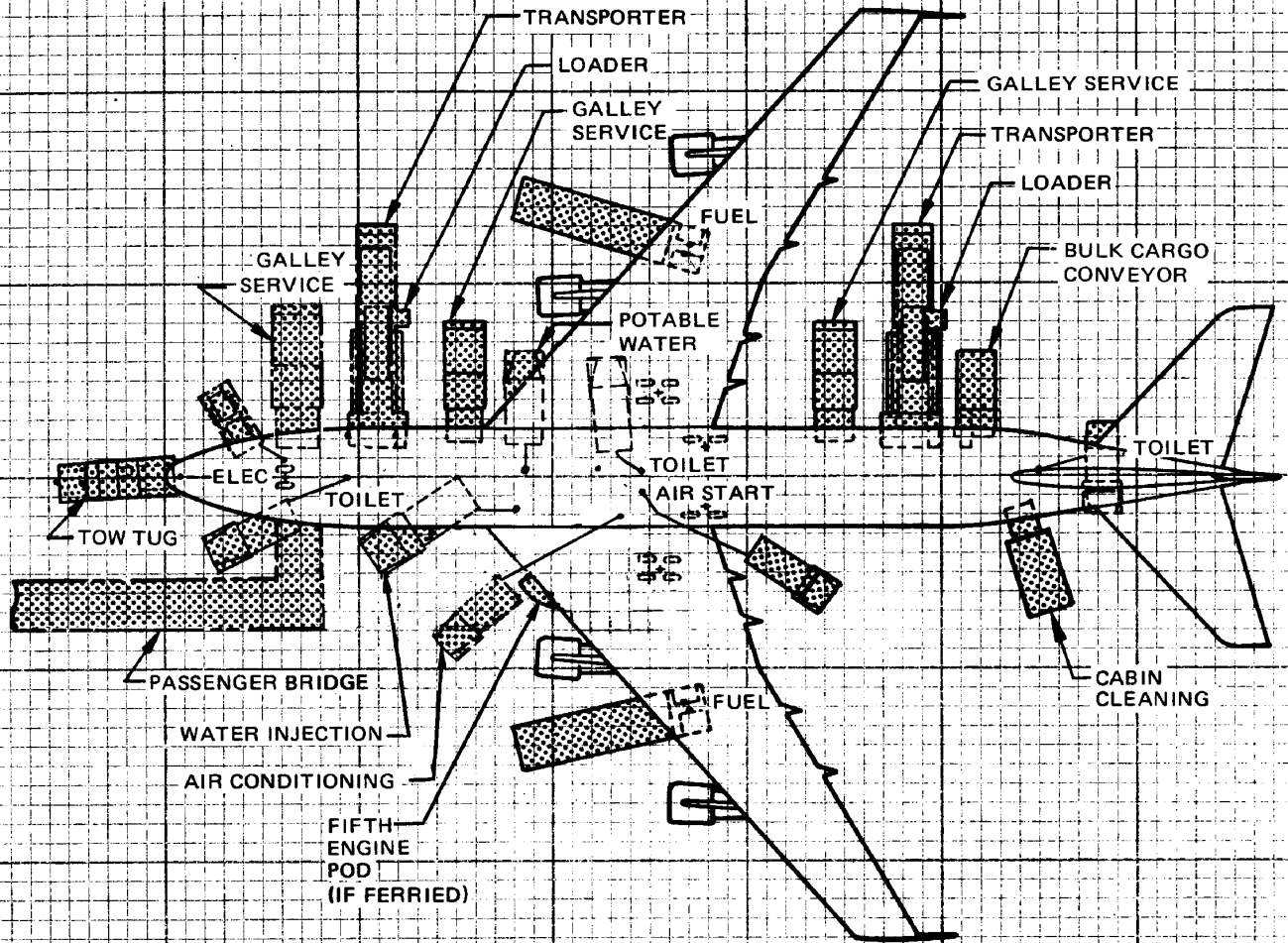

**5.1.1 AIRPLANE SERVICING ARRANGEMENT (TYPICAL TURNAROUND) — PASSENGER
 MODELS 747-100B, -200B, -200C, -300**

NOTES:

- UNDER NORMAL CONDITIONS, EXTERNAL ELECTRICAL POWER, AIR START, AND AIR CONDITIONING ARE NOT REQUIRED WHEN THE AUXILIARY POWER UNIT IS USED.
- FOR 6-PALLET CONFIGURATION, AFT GALLEY IS SERVICED THROUGH RH NO. 4 DOOR, SEQUENCE WITH AFT LOWER LOBE LOADER BAGGAGE TRAIN.
- CABIN CLEANING CREW USES PASSENGER STAIRS.

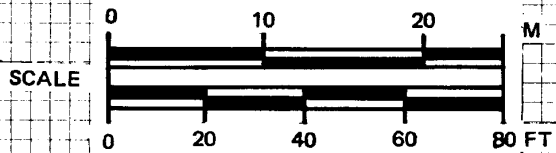
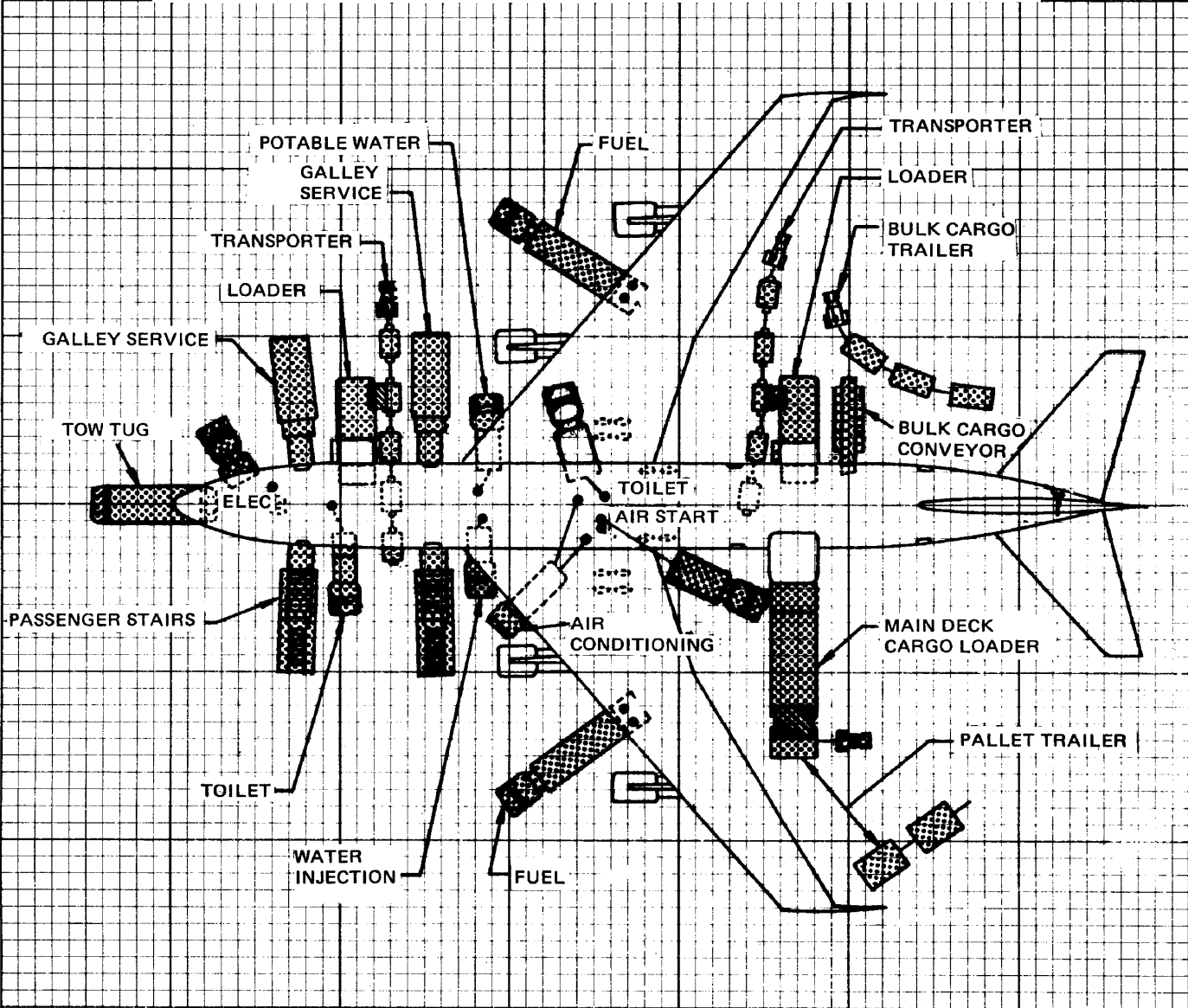

5.1.2 AIRPLANE SERVICING ARRANGEMENT (TYPICAL TURNAROUND) — PASSENGER/CARGO MODELS 747-200B COMBI, -300 COMBI

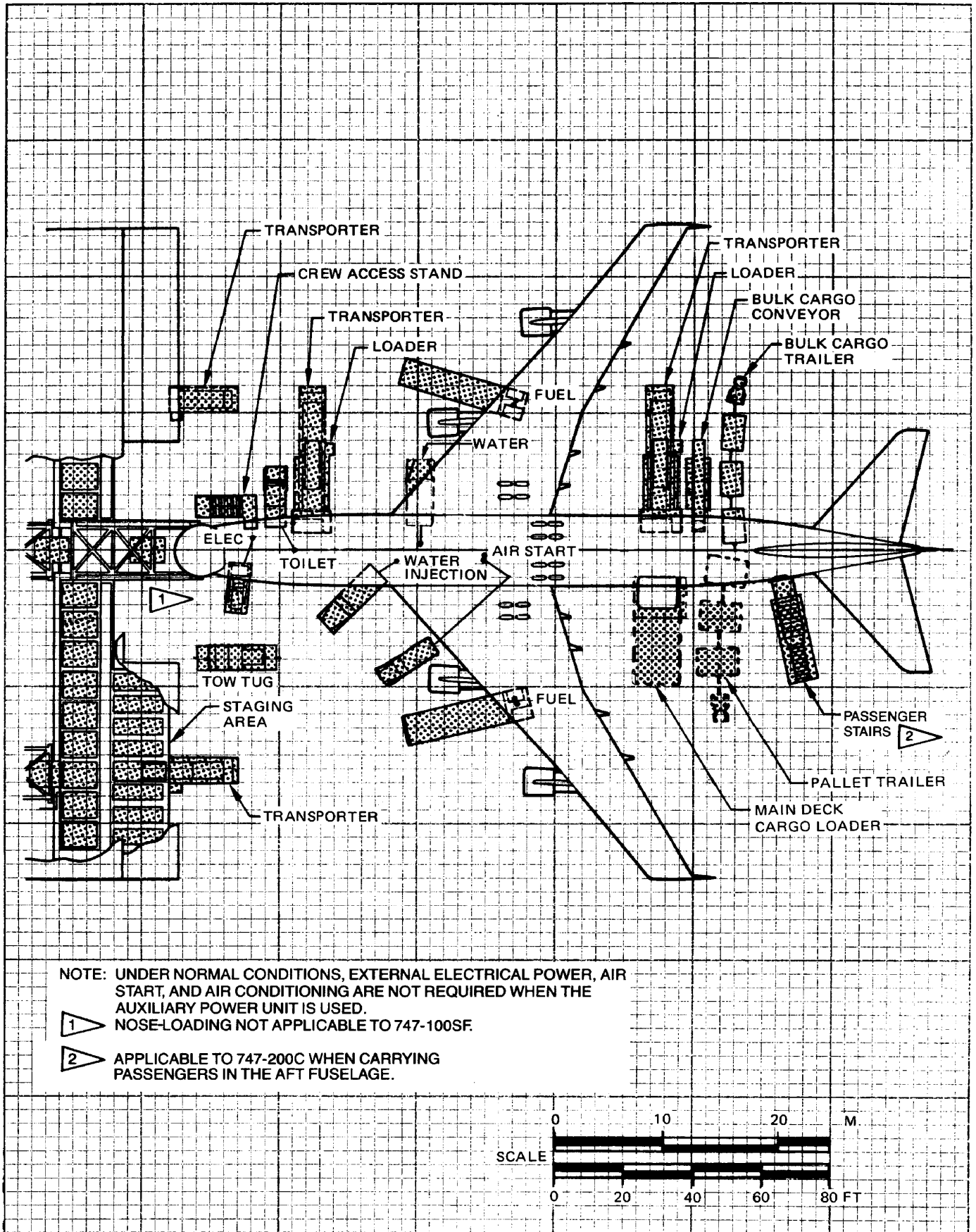

5.1.3 AIRPLANE SERVICING ARRANGEMENT (TYPICAL TURNAROUND) — CARGO
MODELS 747-100SF, -200C, -200F

NOTE: UNDER NORMAL CONDITIONS, EXTERNAL ELECTRICAL POWER, AIR START, AND AIR CONDITIONING ARE NOT REQUIRED WHEN THE AUXILIARY POWER UNIT IS USED.

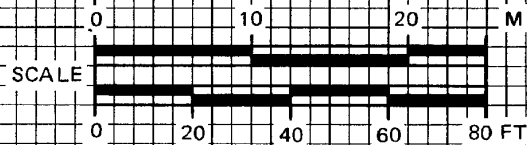
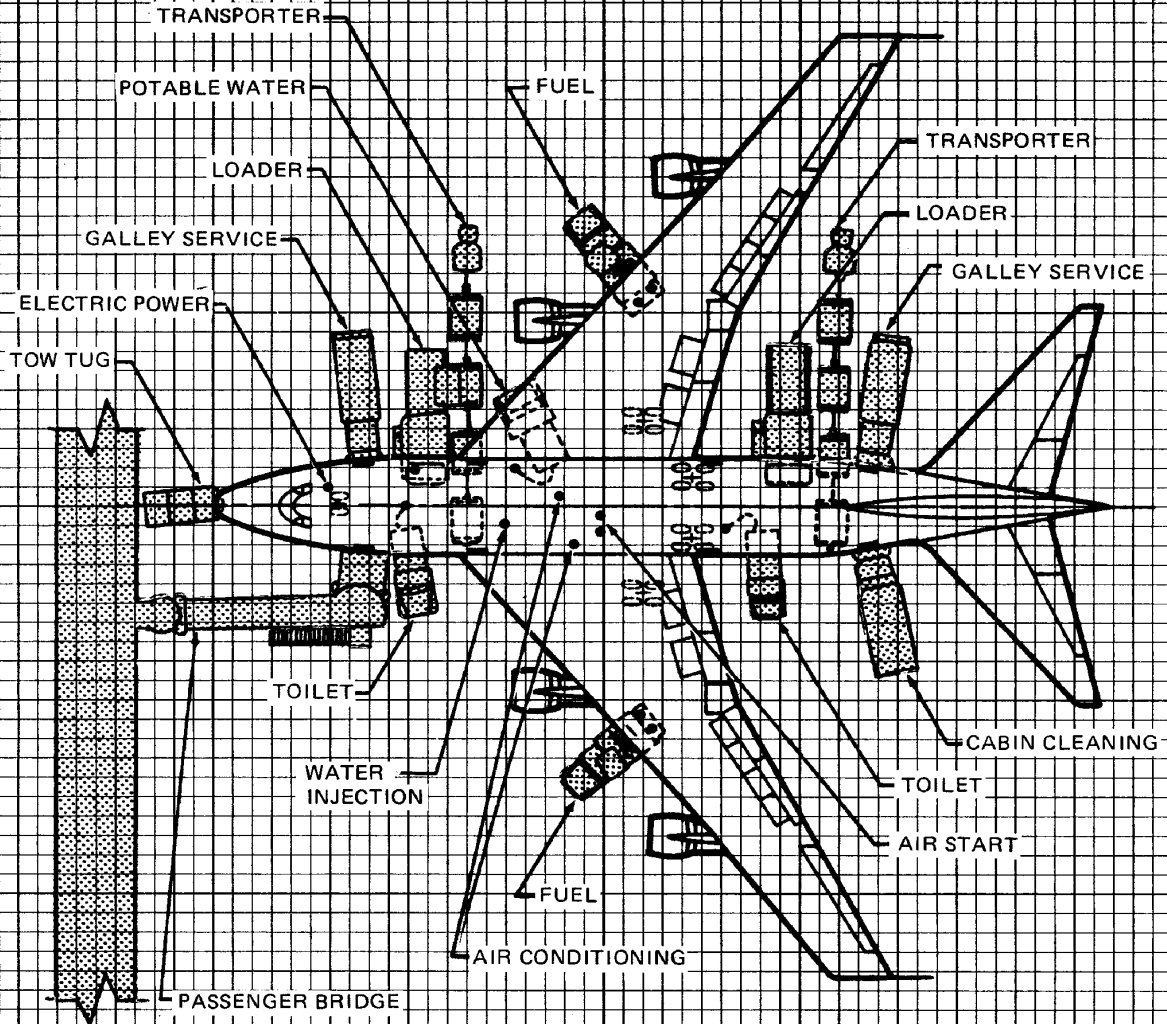

5.1.4 AIRPLANE SERVICING ARRANGEMENT (TYPICAL TURNAROUND) — PASSENGER MODEL 747SP

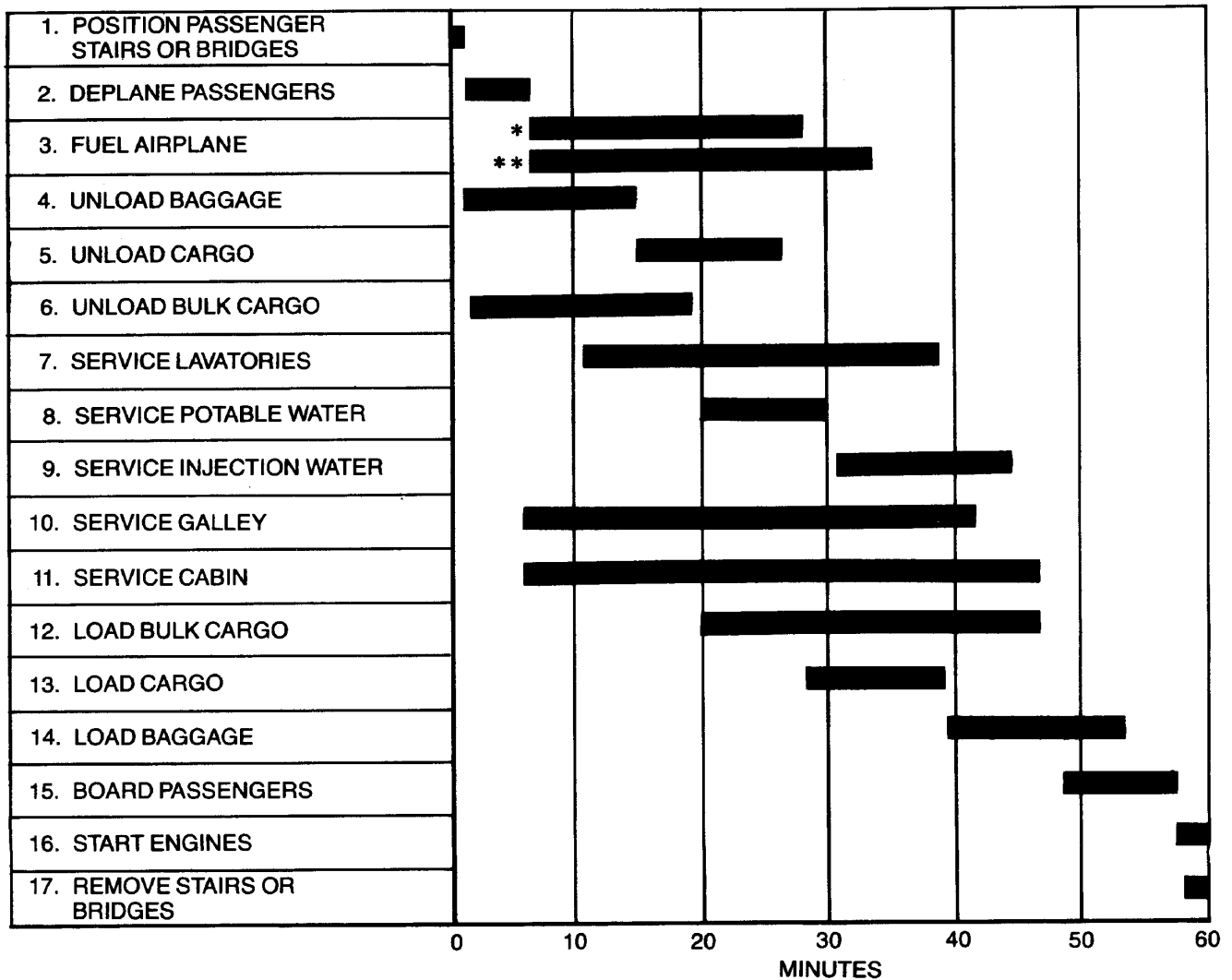

NOTES:

1. ESTIMATES BASED ON MIXED-CLASS CONFIGURATION: TYPICAL FLIGHT FROM SFO-JFK-LON WITH TURNAROUND AT LON.
2. IT IS ASSUMED THAT ALL EQUIPMENT FUNCTIONS PROPERLY AND THAT NO ABNORMAL WEATHER CONDITIONS EXIST. TOTAL TIME ON THE RAMP IS 60 MINUTES.
- *3. AIRPLANE CAPABILITY: 50 PSI (3.52 KG/CM²) SUPPLY — 4 NOZZLES — 2 MOBILE FUEL TRUCKS OR USE HYDRANTS.
- **4. EXISTING FUEL TRUCK CAPABILITY: 35 PSI (2.46 KG/CM²) SUPPLY — 600 GPM (2.271 LPM) PER TRUCK — 2 MOBILE FUEL TRUCKS — 4 NOZZLES — ONE CHANGE OF FUEL TRUCKS.
5. THE ABOVE DATA IS PROVIDED TO ILLUSTRATE THE GENERAL SCOPE AND TYPES OF TASKS INVOLVED IN TERMINAL OPERATIONS. VARYING AIRLINE PRACTICES AND OPERATING CIRCUMSTANCES THROUGHOUT THE WORLD WILL RESULT IN DIFFERENT SEQUENCES AND TIME INTERVALS TO ACCOMPLISH THE TASKS SHOWN.
6. GROUND OPERATIONS REQUIREMENTS SHOULD BE COORDINATED WITH THE USING AIRLINES PRIOR TO RAMP PLANNING.

5.2.1 TERMINAL OPERATIONS (TURNAROUND STATION) — PASSENGER MODELS 747-100B, -200B, -300

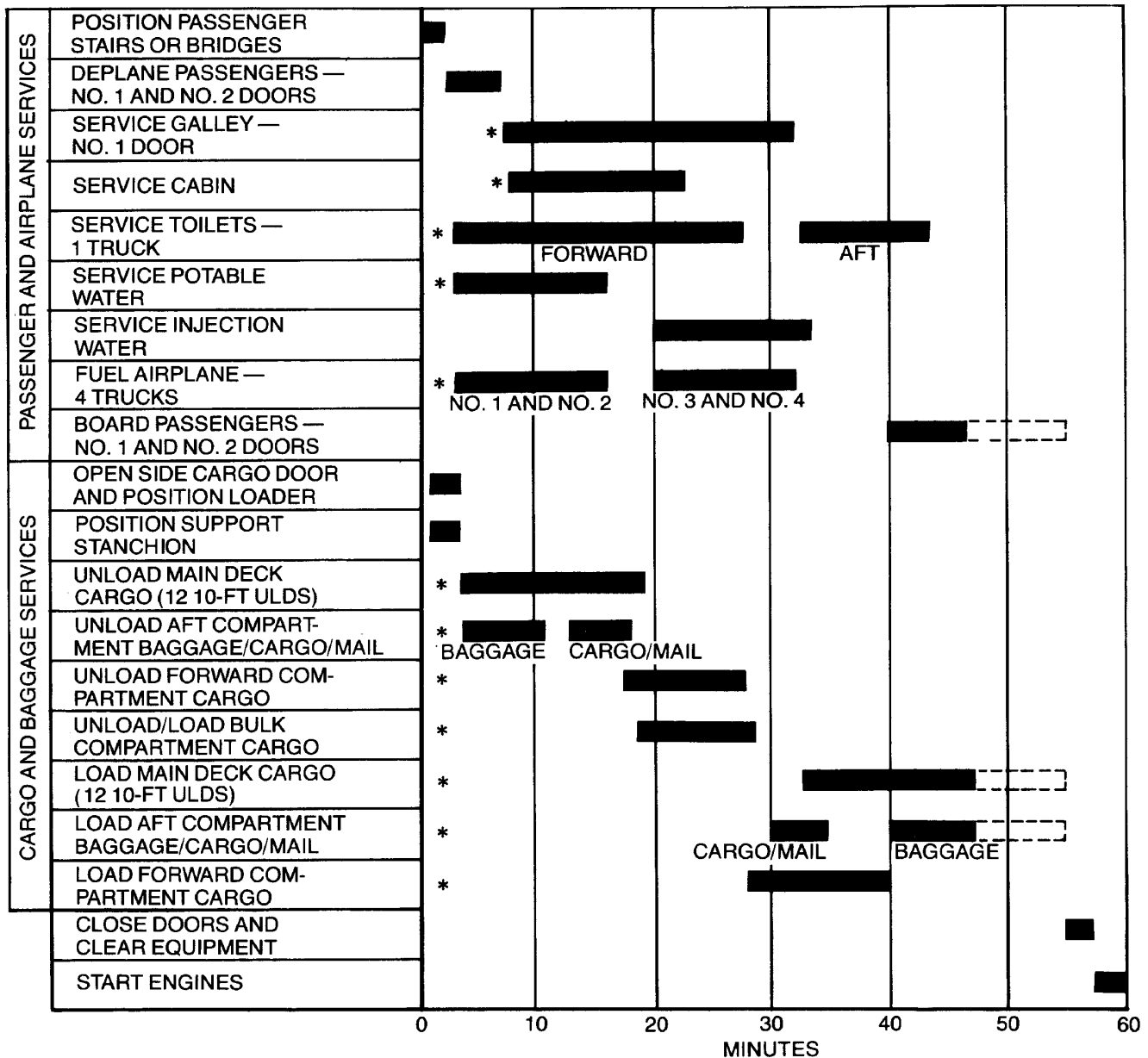

NOTES:

1. ESTIMATES ARE BASED ON MIXED-CLASS/12 ULD CONFIGURATION 100% LOAD FACTOR AND FULL BAGGAGE EXCHANGE.
2. IT IS ASSUMED THAT ALL EQUIPMENT FUNCTIONS PROPERLY AND THAT NO ABNORMAL WEATHER CONDITIONS EXIST. TOTAL TIME ON THE RAMP IS 60 MINUTES.
3. IT IS BEST THAT BOTH PASSENGERS AND CARGO BE HANDLED AT THE PASSENGER TERMINAL, RATHER THAN CARGO BEING LOADED/UNLOADED AT SOME OTHER LOCATION. IF CARGO IS LOADED AT SOME OTHER LOCATION, CARE MUST BE TAKEN THAT THE AIRPLANE CG IS FORWARD OF THE LIMITS SET FOR TOWING OR TAXIING (33% MAC FOR TAXIING — VARIABLE FROM 33% MAC AT 405,000 LB TO 37% MAC AT 664,000 LB FOR TOWING). TIPPING OF THE AIRCRAFT IN A STATIC CONDITION WILL OCCUR AT 44% MAC APPROXIMATELY.
- *4. EQUIPMENT POSITIONING AND REMOVAL TIMES NOT SHOWN.
5. THE ABOVE DATA IS PROVIDED TO ILLUSTRATE THE GENERAL SCOPE AND TYPES OF TASKS INVOLVED IN TERMINAL OPERATIONS. VARYING AIRLINE PRACTICES AND OPERATING CIRCUMSTANCES THROUGHOUT THE WORLD WILL RESULT IN DIFFERENT SEQUENCES AND TIME INTERVALS TO ACCOMPLISH THE TASKS SHOWN.
6. GROUND OPERATIONS REQUIREMENTS SHOULD BE COORDINATED WITH THE USING AIRLINES PRIOR TO RAMP PLANNING.

5.2.2 TERMINAL OPERATIONS (TURNAROUND STATION) — PASSENGER/CARGO
MODELS 747-200B COMBI, -300 COMBI

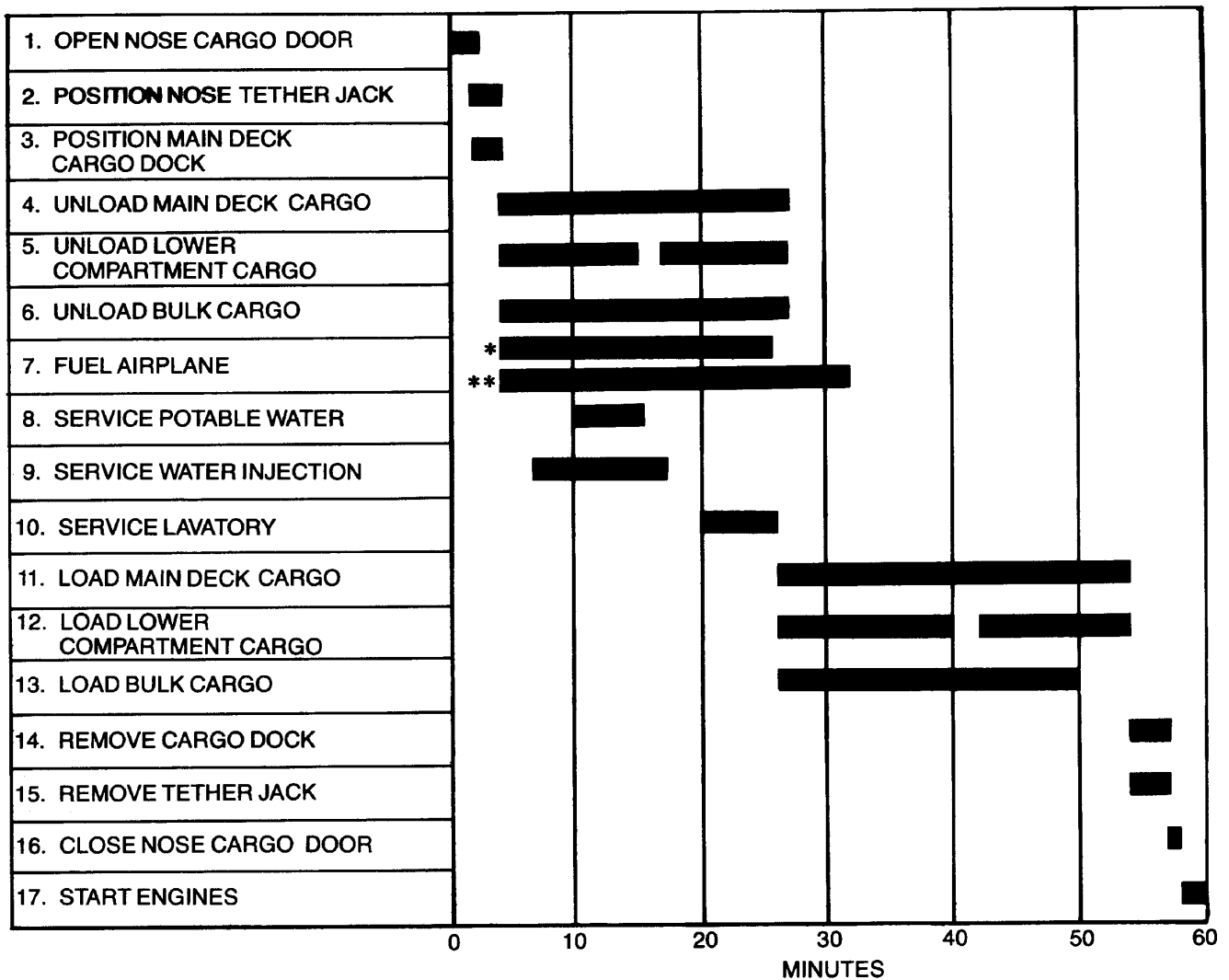

NOTES:

1. IT IS ASSUMED THAT ALL EQUIPMENT FUNCTIONS PROPERLY AND THAT NO ABNORMAL WEATHER CONDITIONS EXIST. TOTAL TIME ON THE RAMP IS 60 MINUTES.
- * 2. AIRPLANE CAPABILITY: 50 PSI (3.52 KG/CM²) SUPPLY — 4 NOZZLES — 2 MOBILE FUEL TRUCKS (15,000 GAL, 56,800 L EACH) OR USE HYDRANTS.
- ** 3. EXISTING FUEL TRUCK CAPABILITY: 35 PSI (2.46 KG/CM²) SUPPLY — 600 GPM (2.271 LPM) PER TRUCK — 2 MOBILE FUEL TRUCKS — 4 NOZZLES — ONE CHANGE OF FUEL TRUCKS.
4. FOR 747-100SF, USE MAIN DECK SIDE CARGO DOOR. CARGO LIMITED TO 20-FOOT CONTAINERS OR PALLETS.
5. THE ABOVE DATA IS PROVIDED TO ILLUSTRATE THE GENERAL SCOPE AND TYPES OF TASKS INVOLVED IN TERMINAL OPERATIONS. VARYING AIRLINE PRACTICES AND OPERATING CIRCUMSTANCES THROUGHOUT THE WORLD WILL RESULT IN DIFFERENT SEQUENCES AND TIME INTERVALS TO ACCOMPLISH THE TASKS SHOWN.
6. GROUND OPERATIONS REQUIREMENTS SHOULD BE COORDINATED WITH THE USING AIRLINES PRIOR TO RAMP PLANNING.

5.2.3 TERMINAL OPERATIONS (TURNAROUND STATION) — CARGO
MODELS 747-100SF, -200C, -200F

TIME IS BASED ON TWO-MAN OPERATION WITH AIRPLANE IN READY CONDITION (ENGINES OFF, DOOR OPEN, NOSE GEAR TETHERED AND CARGO SYSTEM ENERGIZED) AND GROUND SYSTEM CAPABLE OF ACCEPTING AND DELIVERING PALLETS AT AIRPLANE DEMAND RATE.

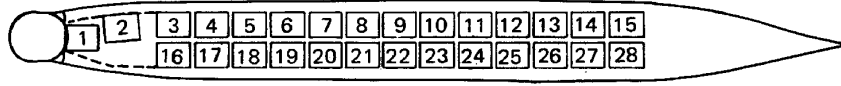

PALLET POSITIONS

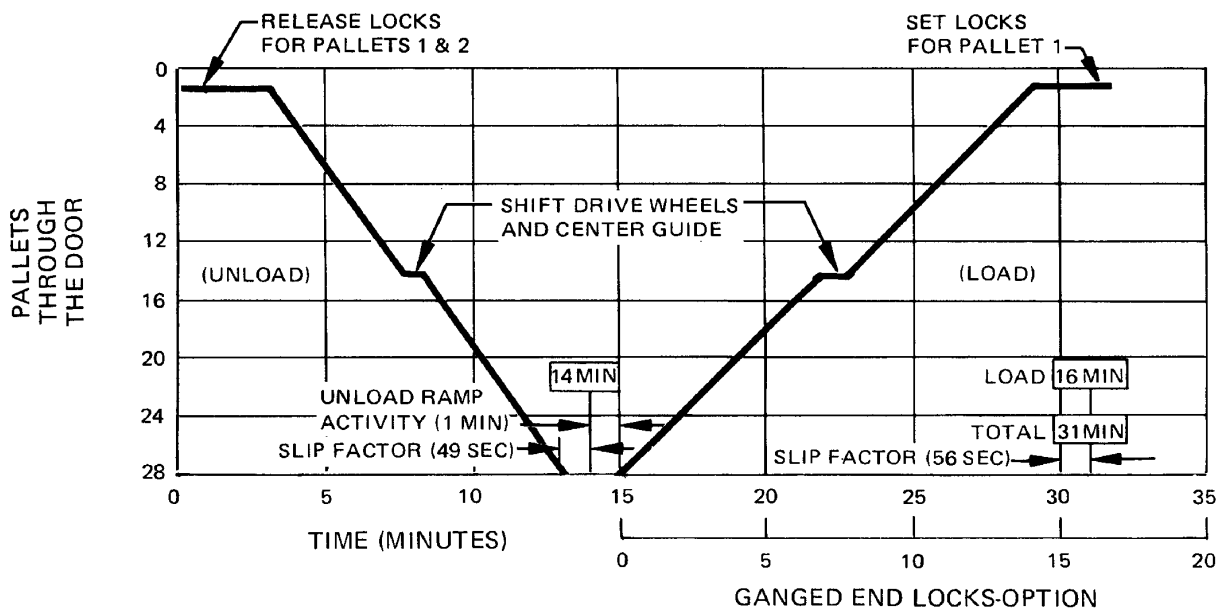
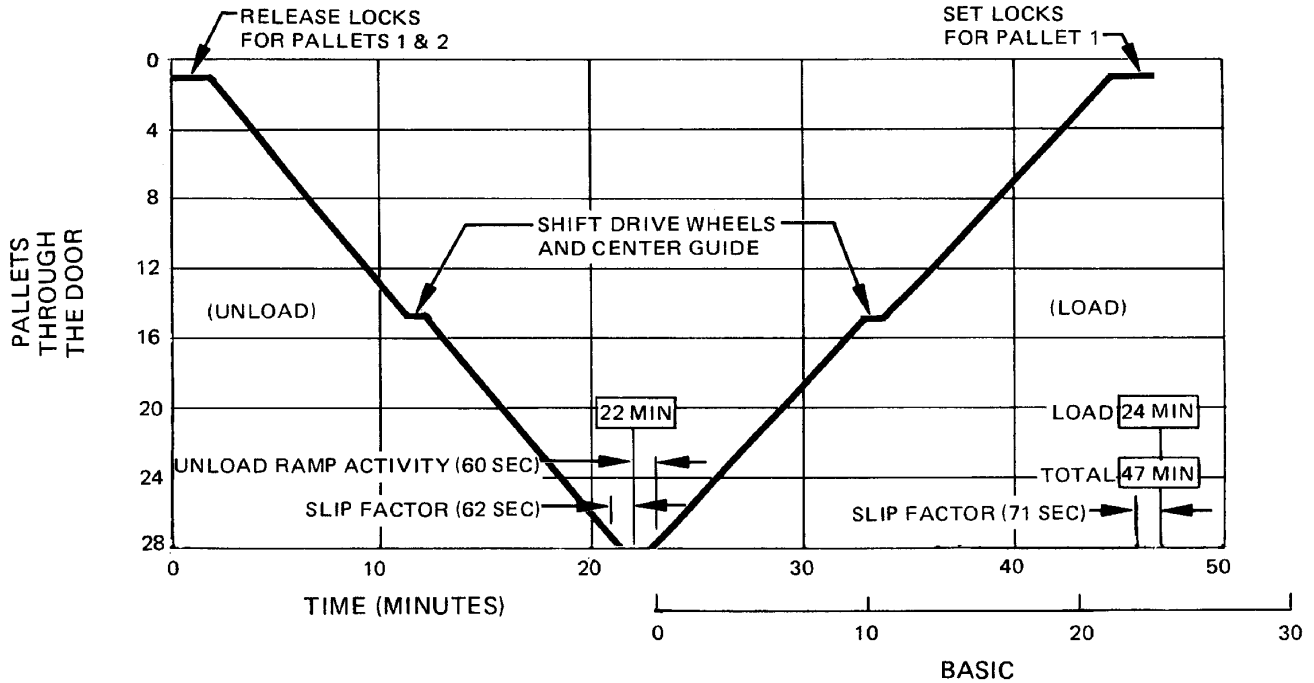

**5.2.4 TERMINAL OPERATIONS (TURNAROUND STATION) - CARGO
MAIN-DECK CARGO LOAD/UNLOAD TIME CYCLE - NOSE CARGO DOOR
MODELS 747-200C, -200F**

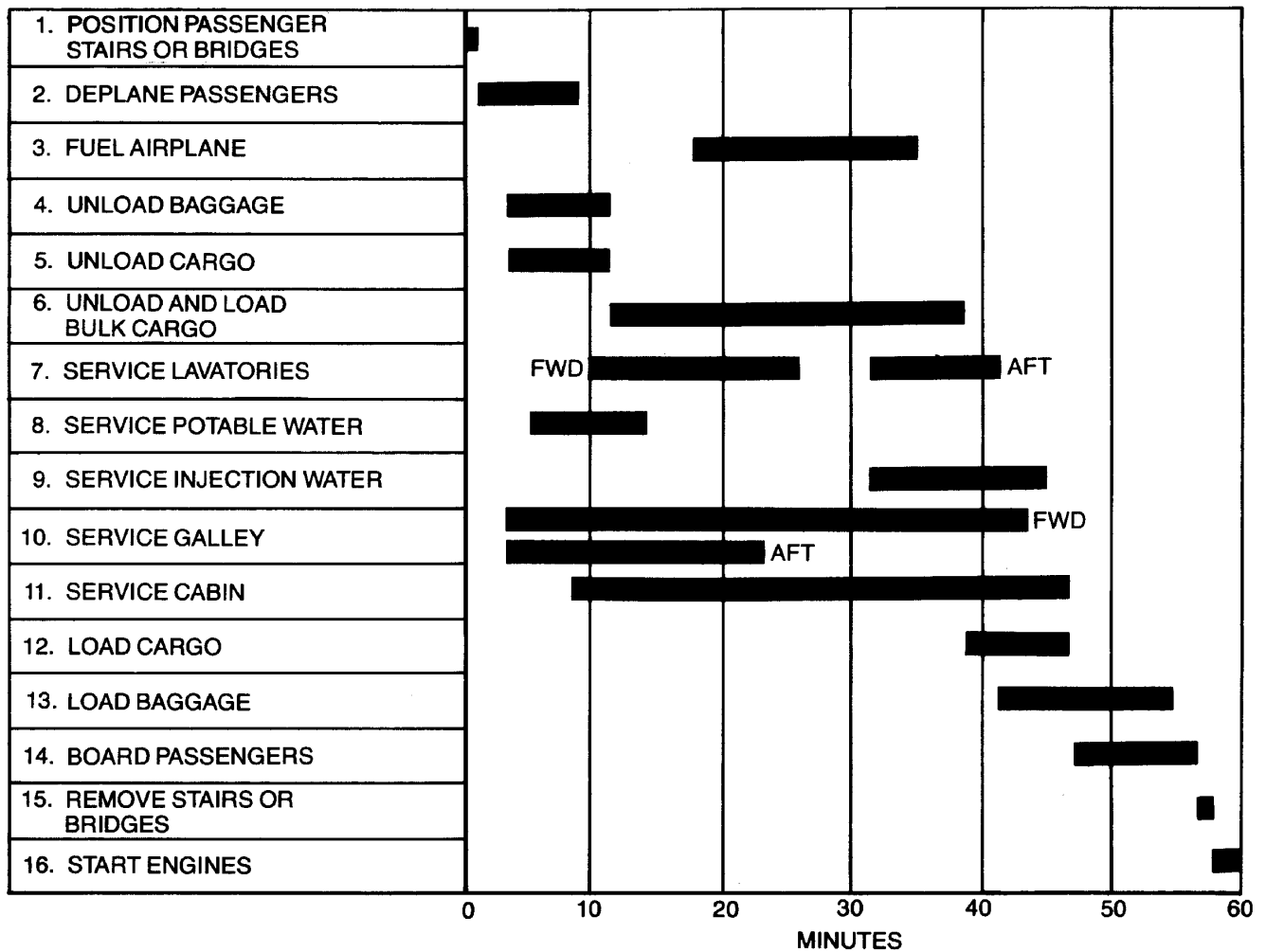

NOTES:

1. ESTIMATES BASED ON MIXED-CLASS CONFIGURATION: 297 PASSENGERS HANDLED USING BRIDGE AT DOOR NO. 1 LH 100% LOAD FACTOR, 100% PASSENGER AND BAGGAGE EXCHANGE.
2. IT IS ASSUMED THAT ALL EQUIPMENT FUNCTIONS PROPERLY AND THAT NO ABNORMAL WEATHER CONDITIONS EXIST. TOTAL TIME ON THE RAMP IS 60 MINUTES.
3. FUELING: 150,000 LB (68,100 KG) — HYDRANT REFUELER, 4 NOZZLES AT 35 PSI (2.46 KG/CM²).
4. THE ABOVE DATA IS PROVIDED TO ILLUSTRATE THE GENERAL SCOPE AND TYPES OF TASKS INVOLVED IN TERMINAL OPERATIONS. VARYING AIRLINE PRACTICES AND OPERATING CIRCUMSTANCES THROUGHOUT THE WORLD WILL RESULT IN DIFFERENT SEQUENCES AND TIME INTERVALS TO ACCOMPLISH THE TASKS SHOWN.
5. GROUND OPERATIONS REQUIREMENTS SHOULD BE COORDINATED WITH THE USING AIRLINES PRIOR TO RAMP PLANNING.

5.2.5 TERMINAL OPERATIONS (TURNAROUND STATION) — PASSENGER MODEL 747SP

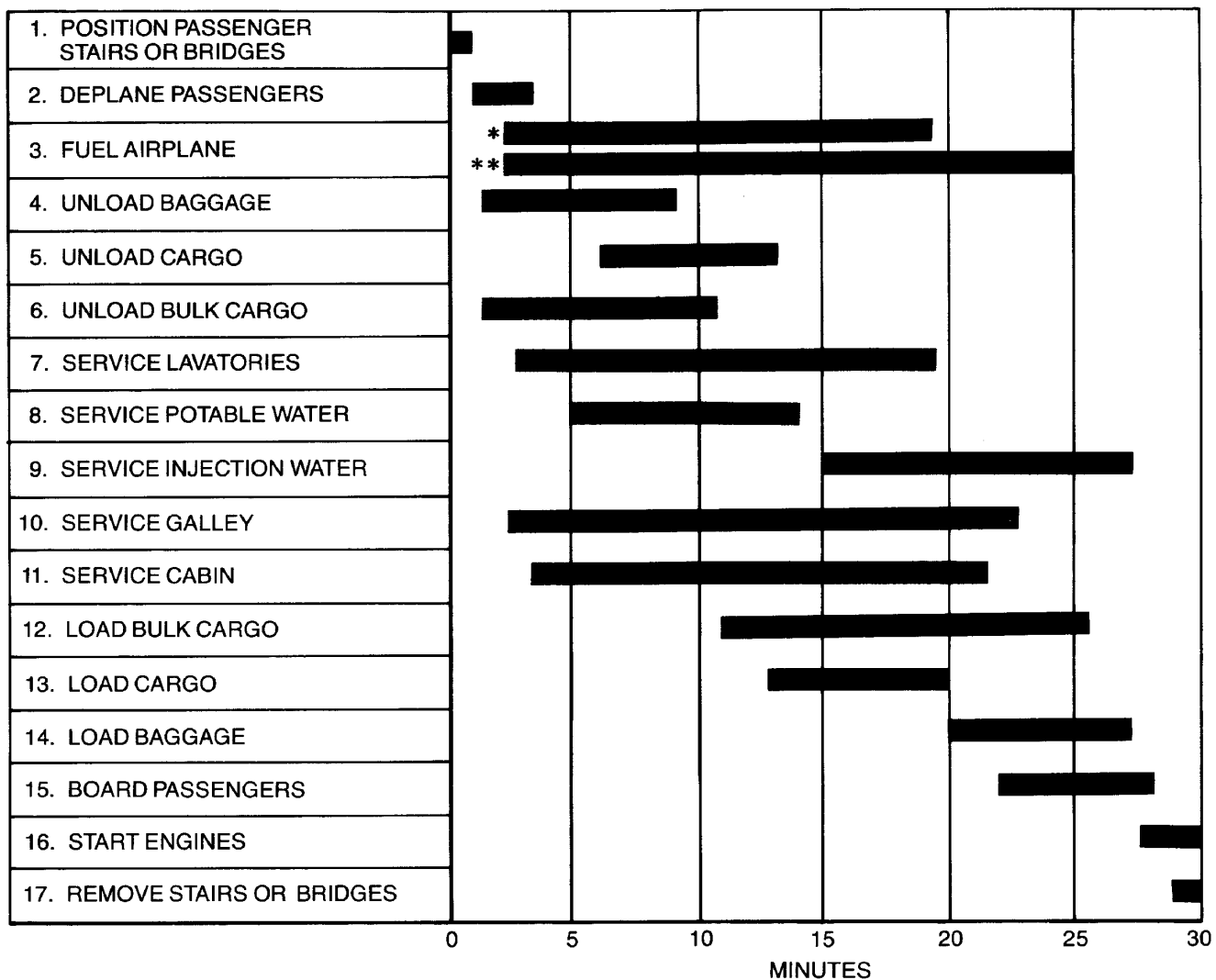

NOTES:

1. ESTIMATES BASED ON MIXED-CLASS CONFIGURATION: TYPICAL FLIGHT FROM LON-JFK-SFO WITH THROUGH STOP AT JFK AND 50% PASSENGER, BAGGAGE, CARGO EXCHANGE.
2. IT IS ASSUMED THAT ALL EQUIPMENT FUNCTIONS PROPERLY AND THAT NO ABNORMAL WEATHER CONDITIONS EXIST. TOTAL TIME ON THE RAMP IS 30 MINUTES.
- *3. AIRPLANE CAPABILITY: 50 PSI (3.52 KG/CM²) SUPPLY — 4 NOZZLES — 2 MOBILE FUEL TRUCKS OR USE HYDRANTS.
- **4. EXISTING FUEL TRUCK CAPABILITY: 35 PSI (2.46 KG/CM²) SUPPLY — 600 GPM (2,271 LPM) PER TRUCK — 2 MOBILE FUEL TRUCKS — 4 NOZZLES — ONE CHANGE OF FUEL TRUCKS.
5. THE ABOVE DATA IS PROVIDED TO ILLUSTRATE THE GENERAL SCOPE AND TYPES OF TASKS INVOLVED IN TERMINAL OPERATIONS. VARYING AIRLINE PRACTICES AND OPERATING CIRCUMSTANCES THROUGHOUT THE WORLD WILL RESULT IN DIFFERENT SEQUENCES AND TIME INTERVALS TO ACCOMPLISH THE TASKS SHOWN.
6. GROUND OPERATIONS REQUIREMENTS SHOULD BE COORDINATED WITH THE USING AIRLINES PRIOR TO RAMP PLANNING.

**5.3.1 TERMINAL OPERATIONS (EN ROUTE STATION) — PASSENGER
MODELS 747-100B, -200B, -300**

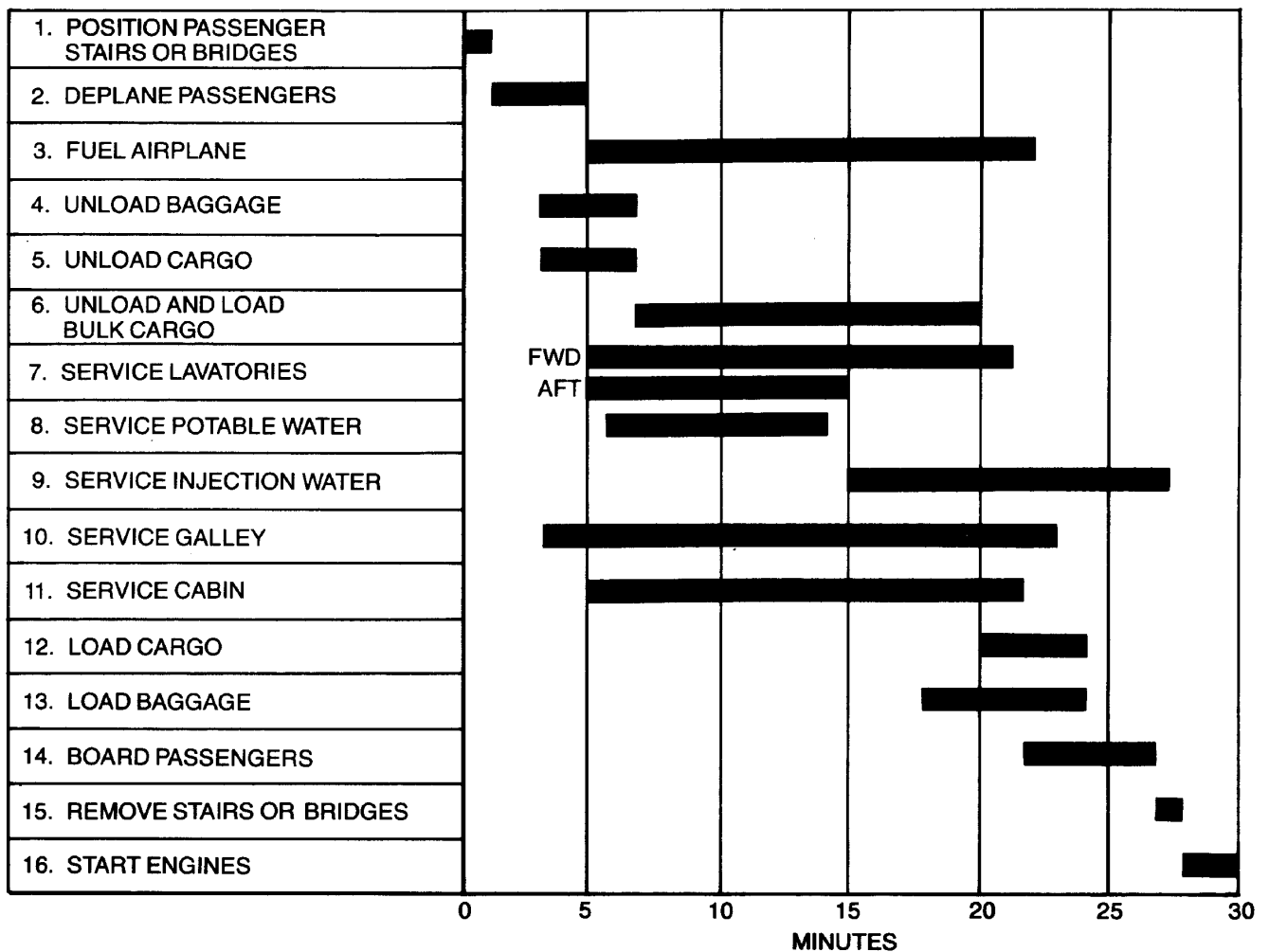

NOTES:

1. ESTIMATES BASED ON MIXED-CLASS CONFIGURATION: 145 PASSENGERS HANDLED USING BRIDGE AT DOOR NO. 1 LH 100% LOAD FACTOR, 50% PASSENGER AND BAGGAGE EXCHANGE.
2. IT IS ASSUMED THAT ALL EQUIPMENT FUNCTIONS PROPERLY AND THAT NO ABNORMAL WEATHER CONDITIONS EXIST. TOTAL TIME ON THE RAMP IS 30 MINUTES.
3. FUELING: 150,000 LB (68,100 KG) — HYDRANT REFUELER, 4 NOZZLES AT 35 PSI (2.46 KG/CM²).
4. THE ABOVE DATA IS PROVIDED TO ILLUSTRATE THE GENERAL SCOPE AND TYPES OF TASKS INVOLVED IN TERMINAL OPERATIONS. VARYING AIRLINE PRACTICES AND OPERATING CIRCUMSTANCES THROUGHOUT THE WORLD WILL RESULT IN DIFFERENT SEQUENCES AND TIME INTERVALS TO ACCOMPLISH THE TASKS SHOWN.
5. GROUND OPERATIONS REQUIREMENTS SHOULD BE COORDINATED WITH THE USING AIRLINES PRIOR TO RAMP PLANNING.

5.3.2 TERMINAL OPERATIONS (EN ROUTE STATION) — PASSENGER MODEL 747SP

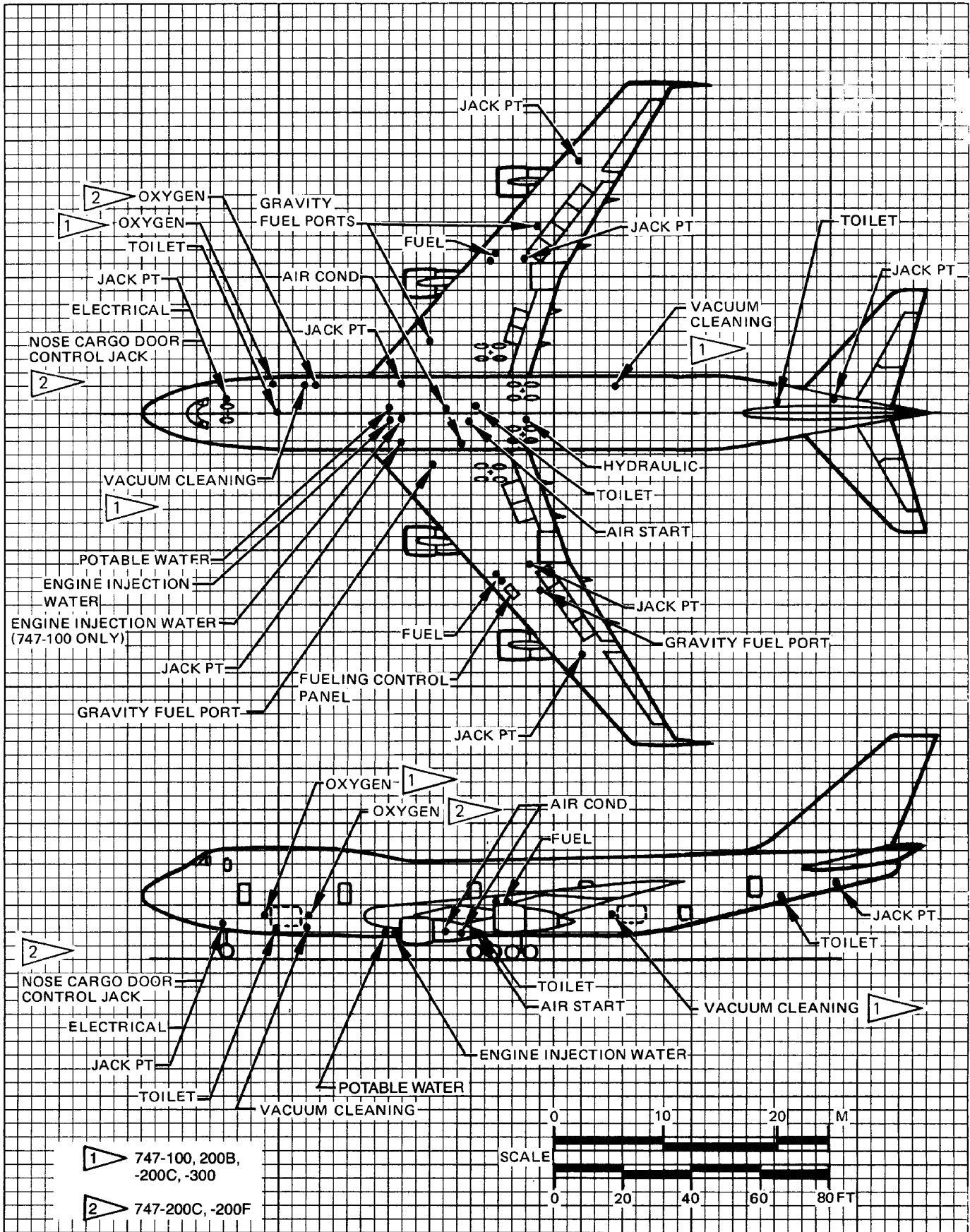

5.4.1 GROUND SERVICE CONNECTIONS
MODELS 747-100, -200, -300

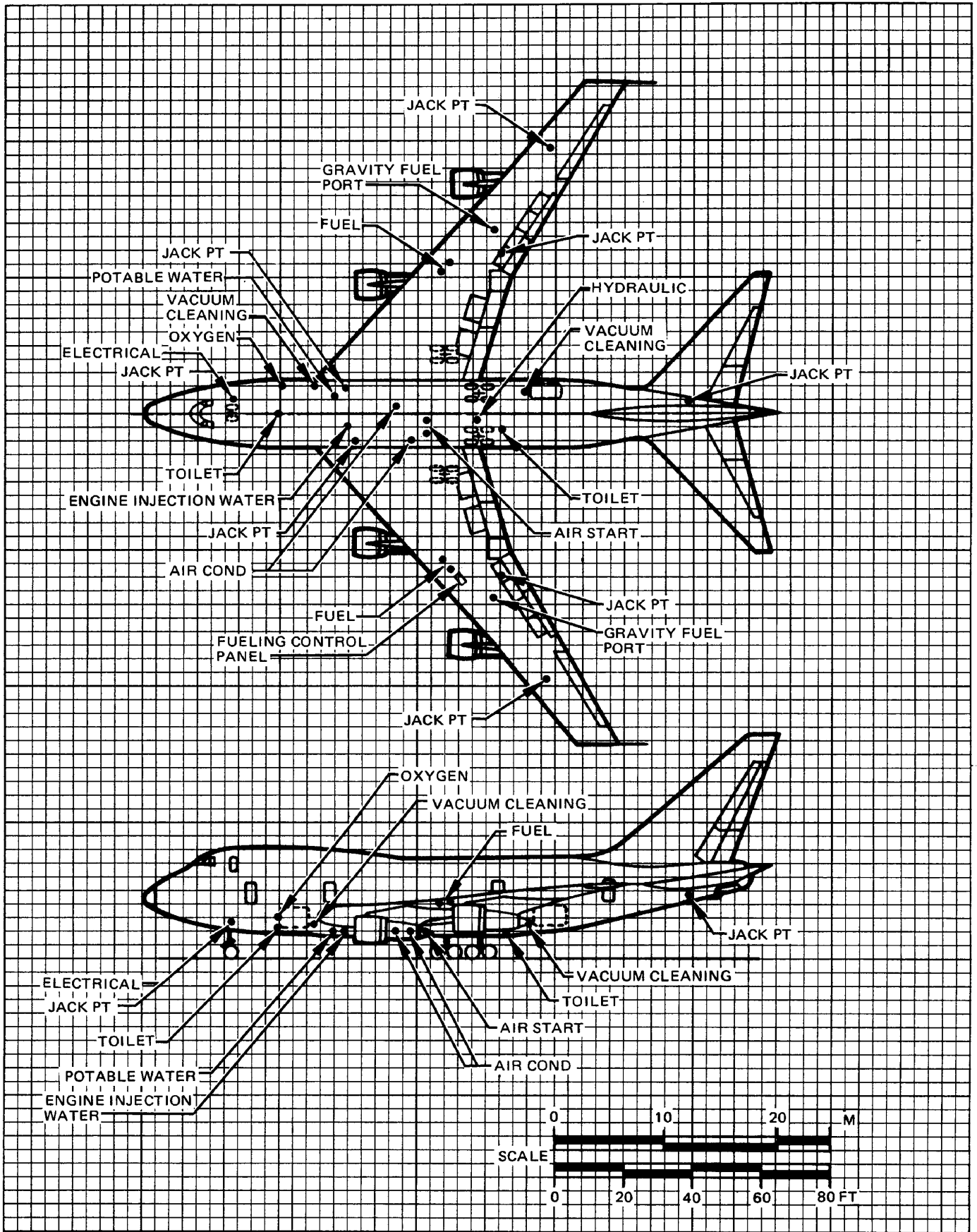

5.4.2 GROUND SERVICE CONNECTIONS
MODEL 747SP

D6-58326

AUGUST 1975

147

SYSTEM REQUIREMENT	DISTANCE AFT OF NOSE		DISTANCE FROM AIRPLANE CENTERLINE				HEIGHT FROM GROUND		
	FEET	METERS	LEFT SIDE		RIGHT SIDE		FEET	METERS	
			FEET	METERS	FEET	METERS			
<p>ELECTRICAL SYSTEM</p> <p>1 SERVICE CONNECTION FOR 747SP 2 SERVICE CONNECTIONS FOR 747-100, -200, AND -300</p> <p>(1) GROUND POWER REQUIRED (EXCLUSIVE OF GALLEYS): 85 KVA AT 115 V, 400 HZ, 3 PHASE NOTE: UNDER NORMAL CONDITIONS, THE AIRPLANE APU WILL PROVIDE THIS POWER.</p> <p>(2) PREDICTED REQUIREMENTS DURING TOWING:</p> <p><u>KVA</u> <u>SYSTEM</u></p> <p>0.1 INTERPHONE 3.0 VACUUM CLEANERS (OPTIONAL) 0.1 BATTERY CHARGER 10.0 GENERAL LIGHTS 1.0 AISLE LIGHTS 1.5 LOWER COMPARTMENT AND SERVICE LIGHTS (PARTIAL USE) 1.0 CONTROL CABIN LIGHTS 0.1 DRAIN MAST HEATERS 2.0 NAVIGATION AND ANTI-COLLISION LIGHTS</p> <p>18.8</p> <p>2.0 AC HYDRAULIC PUMP FOR BRAKES NOTE: THIS REPRESENTS THE AVERAGE LOAD OVER A 5-MINUTE PERIOD. THE ACTUAL LOAD IS 14.4 KVA WHEN THE PUMP IS RUNNING, WHICH WOULD BE FOR 90-SECOND MAXIMUM, AFTER TWO OR THREE BRAKE APPLICATIONS.</p>	27	8.2		4	1.2	9	7	2.7	2.1

5.4.3 GROUND SERVICE CONNECTIONS - ELECTRICAL SYSTEM
MODEL 747

SYSTEM REQUIREMENT	DISTANCE AFT OF NOSE		DISTANCE FROM AIRPLANE CENTERLINE				HEIGHT FROM GROUND																									
	FEET	METERS	LEFT SIDE		RIGHT SIDE		FEET	METERS																								
			FEET	METERS	FEET	METERS	MAX.	MIN.																								
FUEL SYSTEM (1) 4 UNDERWING PRESSURE CONNECTIONS (2 EACH WING) (2.5 IN., 6.4 CM) 50 PSIG (3.52 KG/CM ²) MAXIMUM MAXIMUM FUELING RATE, 500 U.S. GPM (1,890 LPM) PER NOZZLE; 2,000 U.S. GPM (7,570 LPM) TOTAL	747-100, -200, -300																															
	106	32.3	46	14	46	14	16	15																								
	747SP																															
	88	26.9	46	14	46	14	16	15																								
<table border="1"> <thead> <tr> <th>TANK</th> <th>VOL.*</th> <th>747-100B 747SP</th> <th>747-200 747-300</th> </tr> </thead> <tbody> <tr> <td>RESERVE NO. 1 & 4</td> <td>U.S. GAL. L</td> <td>500 EA 1,890</td> <td>530 EA 2,000</td> </tr> <tr> <td>MAIN NO. 1 & 4</td> <td>U.S. GAL. L</td> <td>4,420 EA 16,730</td> <td>4,490 EA 16,970</td> </tr> <tr> <td>MAIN NO. 2 & 3</td> <td>U.S. GAL. L</td> <td>12,240 EA 46,330</td> <td>12,570 EA 47,510</td> </tr> <tr> <td>CENTER WING</td> <td>U.S. GAL. L</td> <td>12,890 48,790</td> <td>17,160 64,860</td> </tr> <tr> <td>TOTAL</td> <td>U.S. GAL. L</td> <td>47,210 178,700</td> <td>52,340 197,820</td> </tr> </tbody> </table> <p>*VOLUMES GIVEN ARE TYPICAL FUEL QUANTITIES AND MAY VARY WITH CUSTOMER OPTIONS.</p>	TANK	VOL.*	747-100B 747SP	747-200 747-300	RESERVE NO. 1 & 4	U.S. GAL. L	500 EA 1,890	530 EA 2,000	MAIN NO. 1 & 4	U.S. GAL. L	4,420 EA 16,730	4,490 EA 16,970	MAIN NO. 2 & 3	U.S. GAL. L	12,240 EA 46,330	12,570 EA 47,510	CENTER WING	U.S. GAL. L	12,890 48,790	17,160 64,860	TOTAL	U.S. GAL. L	47,210 178,700	52,340 197,820	747-100, -200, -300 (4 CONNECTIONS)							
	TANK	VOL.*	747-100B 747SP	747-200 747-300																												
	RESERVE NO. 1 & 4	U.S. GAL. L	500 EA 1,890	530 EA 2,000																												
	MAIN NO. 1 & 4	U.S. GAL. L	4,420 EA 16,730	4,490 EA 16,970																												
MAIN NO. 2 & 3	U.S. GAL. L	12,240 EA 46,330	12,570 EA 47,510																													
CENTER WING	U.S. GAL. L	12,890 48,790	17,160 64,860																													
TOTAL	U.S. GAL. L	47,210 178,700	52,340 197,820																													
83	25.3	17	5.2	17	5.2			(TOP OF WING)																								
115	35.0	52	15.8	52	15.8			(TOP OF WING)																								
747SP (2 CONNECTIONS)																																
100	30.5	54	16.5	54	16.5			(TOP OF WING)																								

5.4.4 GROUND SERVICE CONNECTIONS - FUEL SYSTEM
MODEL 747

SYSTEM REQUIREMENT	DISTANCE AFT OF NOSE		DISTANCE FROM AIRPLANE CENTERLINE				HEIGHT FROM GROUND		
	FEET	METERS	LEFT SIDE		RIGHT SIDE		FEET	METERS	
			FEET	METERS	FEET	METERS			
<p>HYDRAULIC SYSTEM</p> <p>(1) 1 SERVICE CONNECTION (SIZE AND TYPE IS A CUSTOMER OPTION) FOR RESERVOIR CENTRAL FILL</p> <p>4 RESERVOIRS:</p> <p>ENGINE 1—9.5 U.S. GAL (35.9 L)</p> <p>ENGINE 2—5.5 U.S. GAL (20.8 L)</p> <p>ENGINE 3—5.5 U.S. GAL (20.8 L)</p> <p>ENGINE 4—9.5 U.S. GAL (35.9 L)</p> <p>150 PSIG (10.6 KG/CM²) MAXIMUM</p> <p>(2) EMERGENCY FILL PROVISIONS (SAME LOCATION AS ABOVE):</p> <p>HAND PUMP</p> <p>STOWED FILLER HOSE</p>	747-100, -200, -300								
	114	34.7	0.83	0.25			7	2.1	2.1
	747SP								
	97	29.6	0.83	0.25		7	2.1	2.1	
<p>OXYGEN SYSTEM</p> <p>1 SERVICE CONNECTION (3/16 IN., 0.48 CM)</p> <p>1850 PSIG (130 KG/CM²) MAXIMUM CREW SUPPLY—(1) 115 CU FT* BOTTLE</p> <p>PASS. SUPPLY—(4) 115 CU FT* BOTTLES (747SP ONLY) PASS. SUPPLY—(3) 115 CU FT* BOTTLES</p> <p>*115 CU FT = 3,250 LITERS</p>	747-100, SP, -200B, -300								
	39	11.9			8		15	4.6	4.0
	747-200C AND 200F								
	48	14.6			8		15	4.6	4.0

5.4.5 GROUND SERVICE CONNECTIONS - HYDRAULIC AND OXYGEN SYSTEMS
MODEL 747

SYSTEM REQUIREMENT	DISTANCE AFT OF NOSE		DISTANCE FROM AIRPLANE CENTERLINE				HEIGHT FROM GROUND				
	FEET	METERS	LEFT SIDE		RIGHT SIDE		FEET				
			FEET	METERS	FEET	METERS	MAX.	MIN.			
<u>PNEUMATIC SYSTEM</u> (1) 2 GROUND CONDITIONED AIR CONNECTIONS (8 IN., 0.20 M) (SEE SEC. 5.6 AND 5.7 FOR GROUND AIR REQUIREMENTS)	747-100, -200, -300										
	89	27.0			2	0.6	8	7	2.4	2.1	
	93	28.3	8	2.4			7	6	2.1	1.8	
	747SP										
	72	22.1			2	0.6	8	7	2.4	2.1	
	77	23.5	8	2.4			7	6	2.1	1.8	
(2) 2 HIGH-PRESSURE AIR CONNECTIONS (3 IN., 0.08 M) (SEE SEC. 5.5 FOR GROUND AIR REQUIREMENTS)	747-100, -200, -300										
	97	29.6	2	0.6			7	6	2.1	1.8	
	97	29.6	3	0.9			7	6	2.1	1.8	
	747SP										
	80	24.4	2	0.6			7	6	2.1	1.8	
	80	24.4	3	0.9			7	6	2.1	1.8	

5.4.6 GROUND SERVICE CONNECTIONS - PNEUMATIC SYSTEM
MODEL 747

SYSTEM REQUIREMENT	DISTANCE AFT OF NOSE		DISTANCE FROM AIRPLANE CENTERLINE				HEIGHT FROM GROUND	
	FEET	METERS	LEFT SIDE		RIGHT SIDE		FEET	
			FEET	METERS	FEET	METERS	MAX.	MIN.
TOILET SYSTEM								
PASSENGER AND CONVERTIBLE AIRPLANES *								
NUMBER OF TOILETS								
SERVICE LOCATION								
3 + 1 (UPPER DECK)	38	11.6	0	0	0	9	2.7	2.1
2	97	29.6			1.2	7	2.1	1.8
6	185	56.4			1.4	16	4.9	4.0
SERVICE CAPACITIES (12 TOILETS)								
WASTE—320 U.S. GAL (1,212 L)								
FLUSH—120 U.S. GAL (454 L)								
CHEMICAL PRECHARGE—56 U.S. GAL (212 L)								
*4-IN. (0.102 M) DRAIN, 1-IN. (0.025 M) FLUSH								
TOILET SYSTEM								
PASSENGER AIRPLANE *								
NUMBER OF TOILETS								
SERVICE LOCATION								
5 + 1 (UPPER DECK)	38	11.6	0	0	0	9	2.7	2.1
4	105	32.0	5	1.5		8	2.4	2.1
SERVICE CAPACITIES (10 TOILETS)								
WASTE—310 U.S. GAL (1,174 L)								
FLUSH—100 U.S. GAL (378 L)								
CHEMICAL PRECHARGE—51 U.S. GAL (193 L)								
*4-IN (0.102 M) DRAIN, 1-IN. (0.025 M) FLUSH								
TOILET SYSTEM								
FREIGHTER AIRPLANE *								
CREW TOILET FORWARD UPPER DECK								
WASTE—23 U.S. GAL (87 L)								
FLUSH—10 U.S. GAL (38 L)								
CHEMICAL PRECHARGE—5.5 U.S. GAL (21 L)								
*4-IN. (0.102 M) DRAIN, 1-IN. (0.025 M) FLUSH								

5.4.7 GROUND SERVICE CONNECTIONS - TOILET SYSTEM
MODEL 747

SYSTEM REQUIREMENT	DISTANCE AFT OF NOSE		DISTANCE FROM AIRPLANE CENTERLINE				HEIGHT FROM GROUND						
	FEET	METERS	LEFT SIDE		RIGHT SIDE		FEET						
			FEET	METERS	FEET	METERS	MAX.	MIN.					
<u>WATER SYSTEM (POTABLE)</u> 1 FILL SERVICE CONNECTION— 3/4 IN. (1.95 CM) TANK CAPACITY: ● 747-100B, -200B, -200C, -300, 330 U.S. GAL. (1,250 L) ● 747SP, 220 U.S. GAL. (833 L) ● 747-200F, 10 U.S. GAL. (37.9 L) FILL PRESSURE—30 PSIG (2.11 KG/CM ²) FILL RATE—30 GAL/MIN (113.5 L/MIN) DRAIN CONNECTION—1 IN. (0.025 M)													
	747-100, -200, -300	22.6			2	0.6	7	6	2.1	1.8			
	747SP	17.1			8	2.4	9	7	2.7	2.1			
<u>WATER INJECTION SYSTEM*</u> 1 FILL SERVICE CONNECTION— 1.25 IN. (3.13 CM) FILL RATE—60 GPM (227 LPM) AT 50 PSI (3.52 KG/CM ²) TANK CAPACITY: ● 747-100B, -200 WITH JT9D-7AW, JT9D-7FW ENGINES—700 U.S. GAL. (2650 L) ● 747SP WITH JT9D-7FW, JT9D-7FW ENGINES—600 U.S. GAL. (2279 L) ● 747-100 WITH JT9D-3AW ENGINES - 400 U.S. GAL. (1,510 L) *AIRPLANES EQUIPPED WITH JT9D-3AW, JT9D-7AW OR JT9D-7FW ENGINES	747-100	22.9			4	1.2			7	6	2.1	1.8	
	75												
	747-200	22.3			3	0.9			7	6	2.1	1.8	
	747SP	17.7			4	1.2			7	6	2.1	1.8	

5.4.8 GROUND SERVICE CONNECTIONS - POTABLE AND INJECTION WATER SYSTEMS MODEL 747

5.5 Engine-Starting Pneumatic Requirements

Engine starting is normally provided by the onboard auxiliary power unit (APU) which supplies compressed air to the pneumatic starter at each turbofan engine. After the first engine is started, high-stage bleed air from that engine may be used to start the remaining engines. If cross-bleed starting is used, the thrust on the first engine is increased to above idle to produce the required pressure to assure the HIGH STAGE bleed air light will remain illuminated before starting the remaining engines.

Engine starting air may also be provided by ground carts supplying compressed air to the starter through two 3-in standard connections. Minimum sea-level engine starting air requirements at the connections are shown on the following pages.

Normal starting time (to start bleed valve closure) is 32 sec per engine for standard day sea-level conditions; however, starts of up to 90 sec, maximum, are possible. If sufficient compressed airflow is not available to start the engine properly, then the start must be aborted to avoid damage to the engine.

Maximum air temperature at ground connector must not exceed 450°F. Maximum steady-state air pressure at ground connector is 45 psig.

- NOTES:
- ESTIMATED AIR PRESSURES AND FLOWS REQUIRED AT AIRPLANE GROUND CONNECTION (G.C.) TO PROVIDE MINIMUM STARTING REQUIREMENTS.
 - FOR TWO BOBRICK GROUND CONNECTORS ONLY (EXCEPT AS NOTED).
 - HAMILTON STANDARD STARTER, MODEL PS700-4
 - JT9D SERIES ENGINES
 - COORDINATE WITH USING AIRLINE FOR SPECIFIC PLANNED OPERATING PROCEDURE.

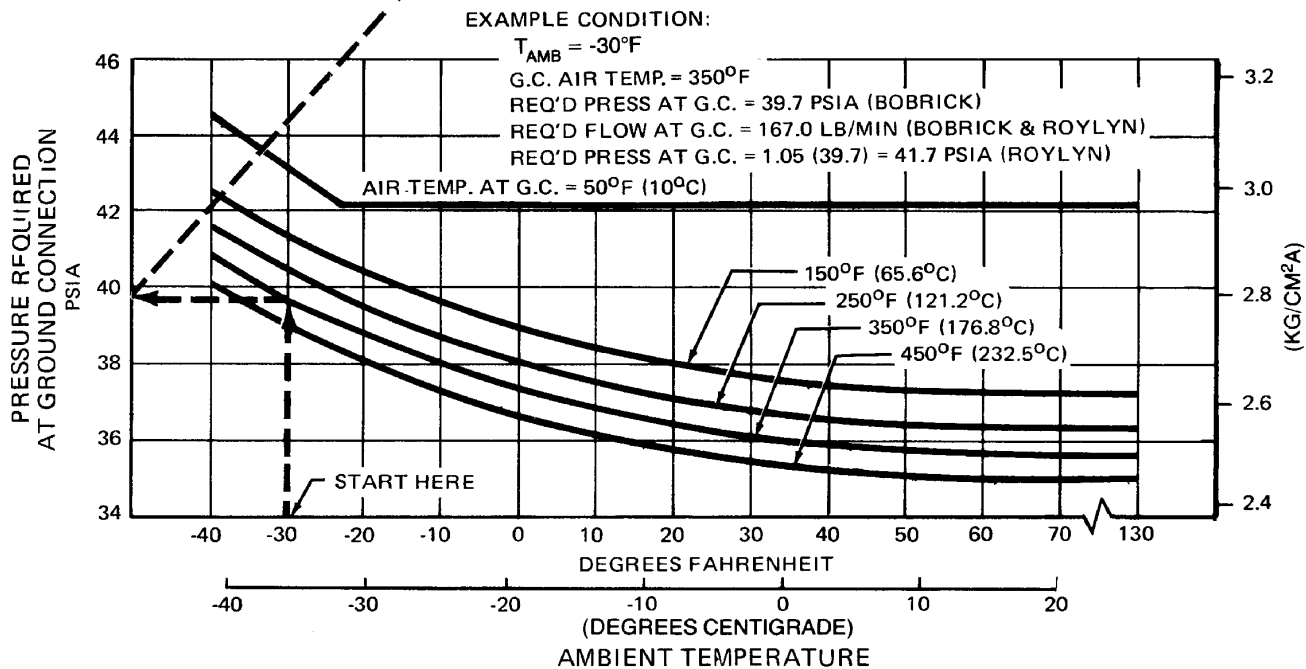
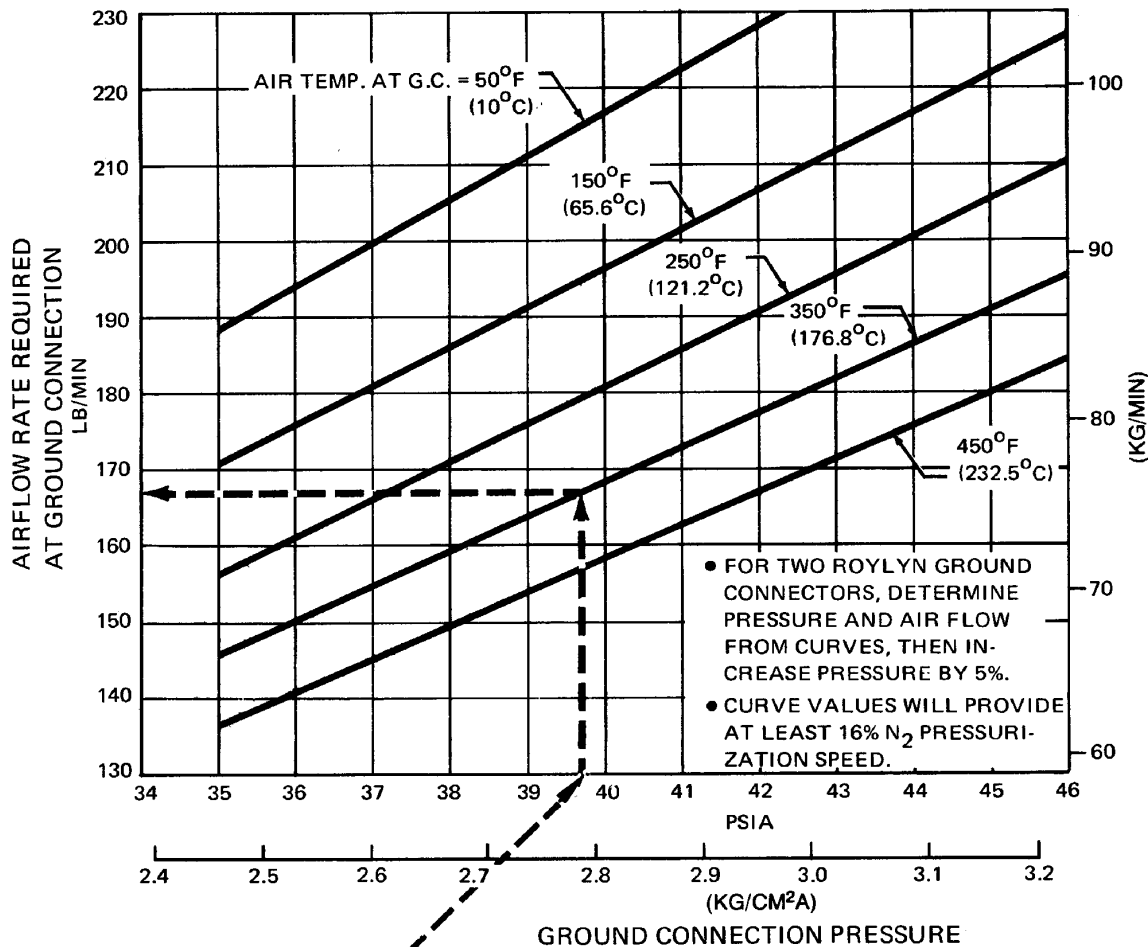

5.5.1 ENGINE-STARTING PNEUMATIC REQUIREMENTS — SEA LEVEL — HAMILTON STANDARD STARTER — JT9D ENGINES MODEL 747

- NOTES:
- ESTIMATED AIR PRESSURES AND FLOWS REQUIRED AT AIRPLANE GROUND CONNECTION (G.C.) TO PROVIDE MINIMUM STARTING REQUIREMENTS
 - FOR TWO BOBRICK GROUND CONNECTORS ONLY (EXCEPT AS NOTED).
 - AIRESEARCH STARTER, MODEL ATS100-384
 - JT9D SERIES ENGINES
 - COORDINATE WITH USING AIRLINE FOR SPECIFIC PLANNED OPERATING PROCEDURE.

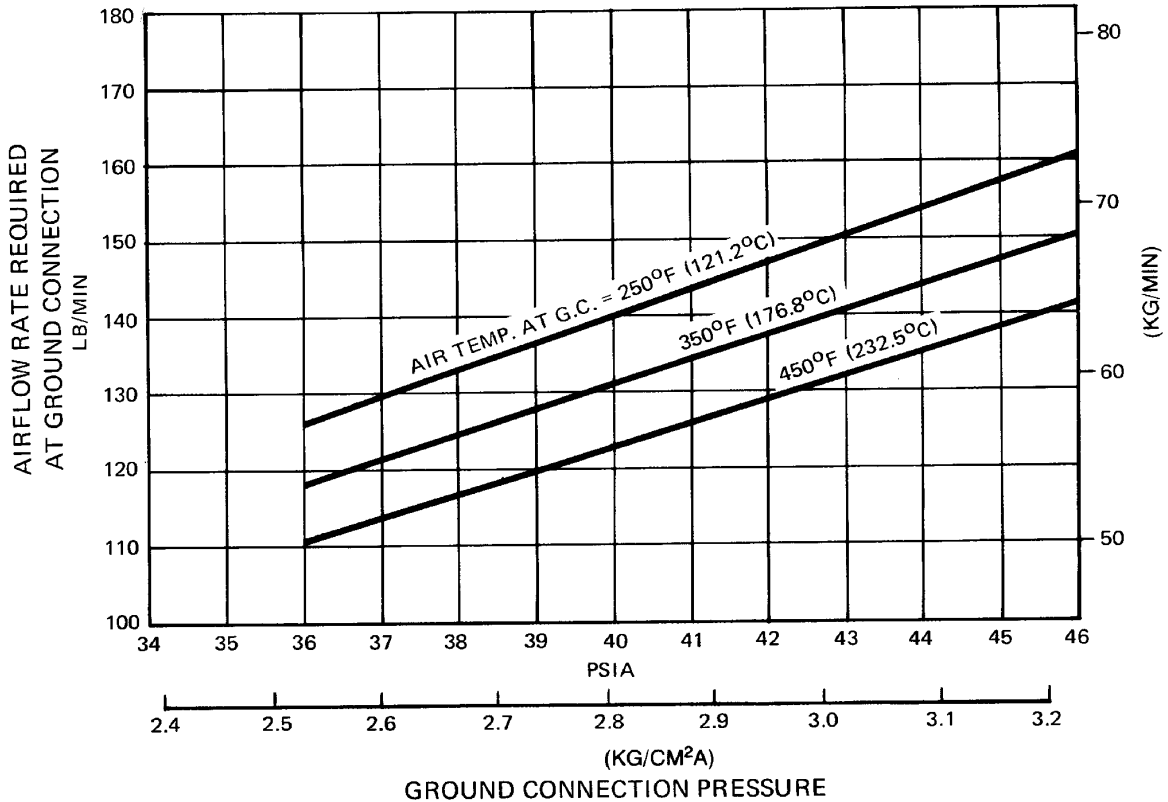

- FOR TWO ROYLYN GROUND CONNECTORS, DETERMINE PRESSURE AND AIR FLOW FROM CURVES, THEN INCREASE PRESSURE BY 5%.
- CURVE VALUES WILL PROVIDE AT LEAST 16% N₂ PRESSURIZATION SPEED.

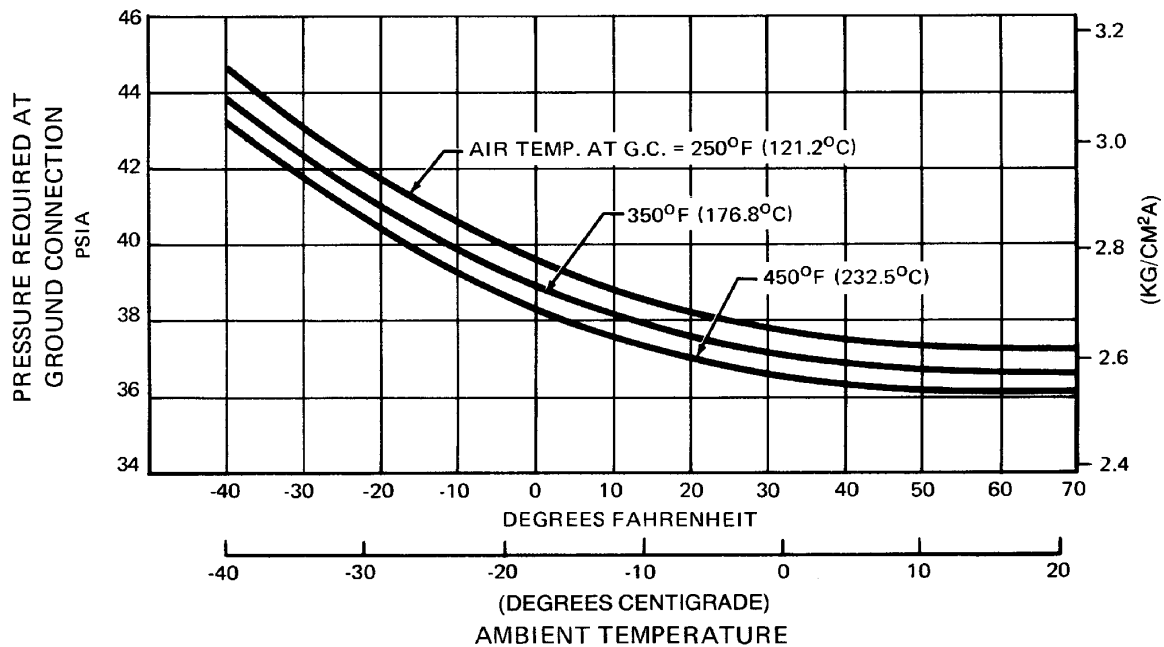

**5.5.2 ENGINE-STARTING PNEUMATIC REQUIREMENTS — SEA LEVEL —
AIRESEARCH STARTER — JT9D ENGINES
MODEL 747**

- NOTES:
- ESTIMATED AIR PRESSURES AND FLOWS REQUIRED AT AIRPLANE GROUND CONNECTION (G.C.) TO PROVIDE MINIMUM STARTING REQUIREMENTS FOR TWO BOBRICK GROUND CONNECTORS ONLY (EXCEPT AS NOTED)
 - AIRESEARCH STARTER, MODEL ATS100-350C
 - CF6-50 SERIES ENGINES
 - COORDINATE WITH USING AIRLINE FOR SPECIFIC PLANNED OPERATING PROCEDURE

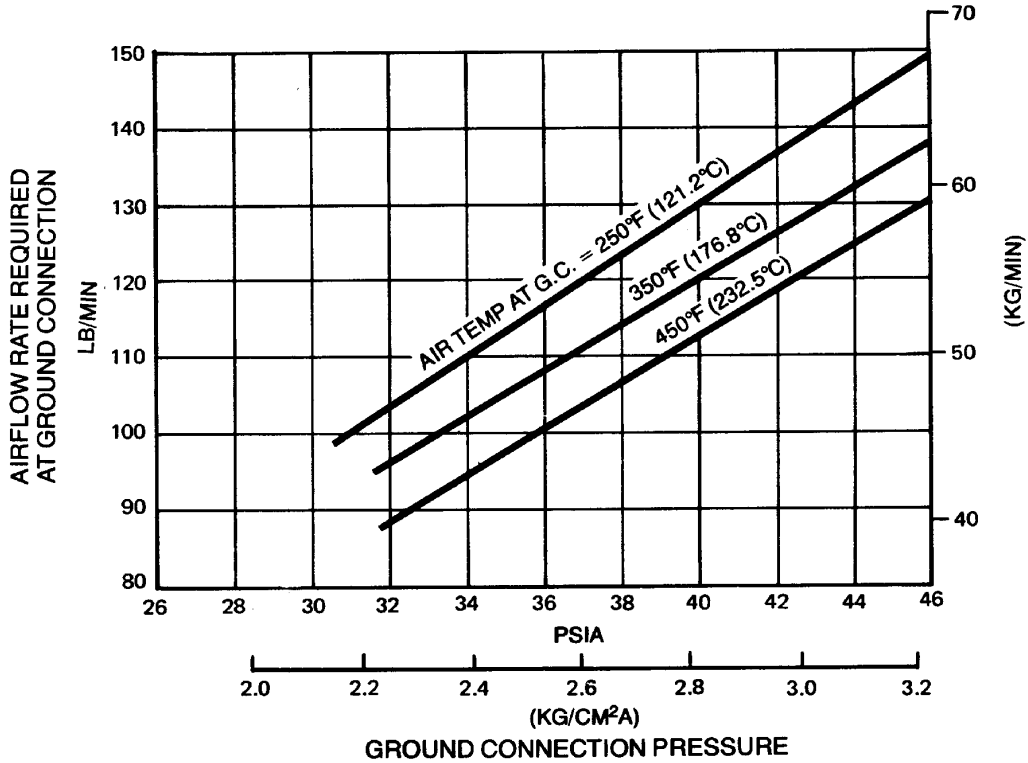

- FOR TWO ROYLYN GROUND CONNECTORS, DETERMINE PRESSURE AND AIR FLOW FROM CURVES, THEN INCREASE PRESSURE BY 5%.
- CURVE VALUES WILL PROVIDE AT LEAST 10% N₂ PRESSURIZATION SPEED.

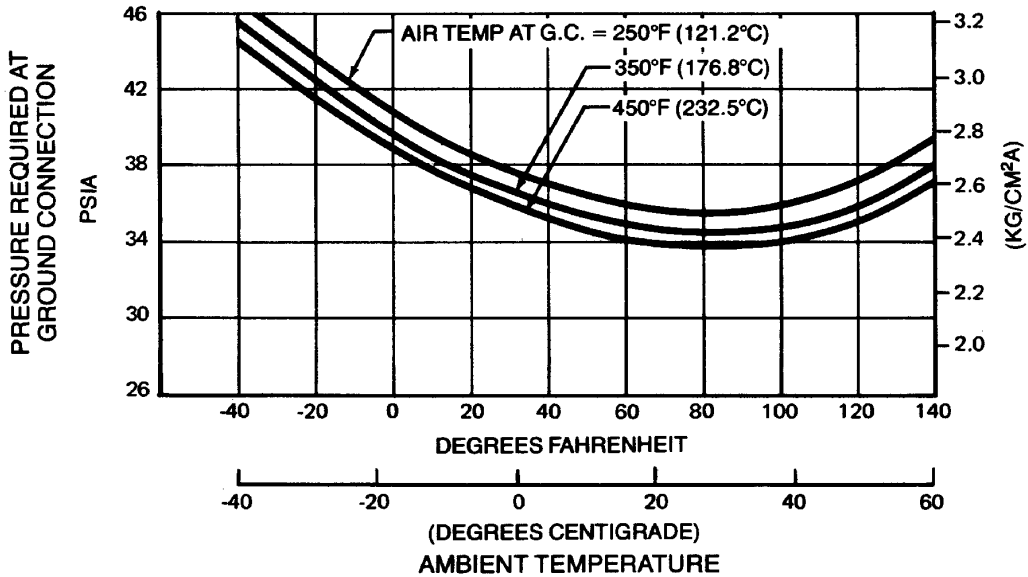

**5.5.3 ENGINE-STARTING PNEUMATIC REQUIREMENTS — SEA LEVEL —
AIRESEARCH STARTER — CF6-50 ENGINES
MODEL 747**

- NOTES:
- ESTIMATED AIR PRESSURES AND FLOWS REQUIRED AT AIRPLANE GROUND CONNECTION (G.C.) TO PROVIDE MINIMUM STARTING REQUIREMENTS
 - FOR TWO BOBRICK GROUND CONNECTORS ONLY (EXCEPT AS NOTED)
 - AIRESEARCH STARTER MODEL ATS100-384D
 - RB211-524 SERIES ENGINES
 - COORDINATE WITH USING AIRLINE FOR SPECIFIC PLANNED OPERATING PROCEDURE

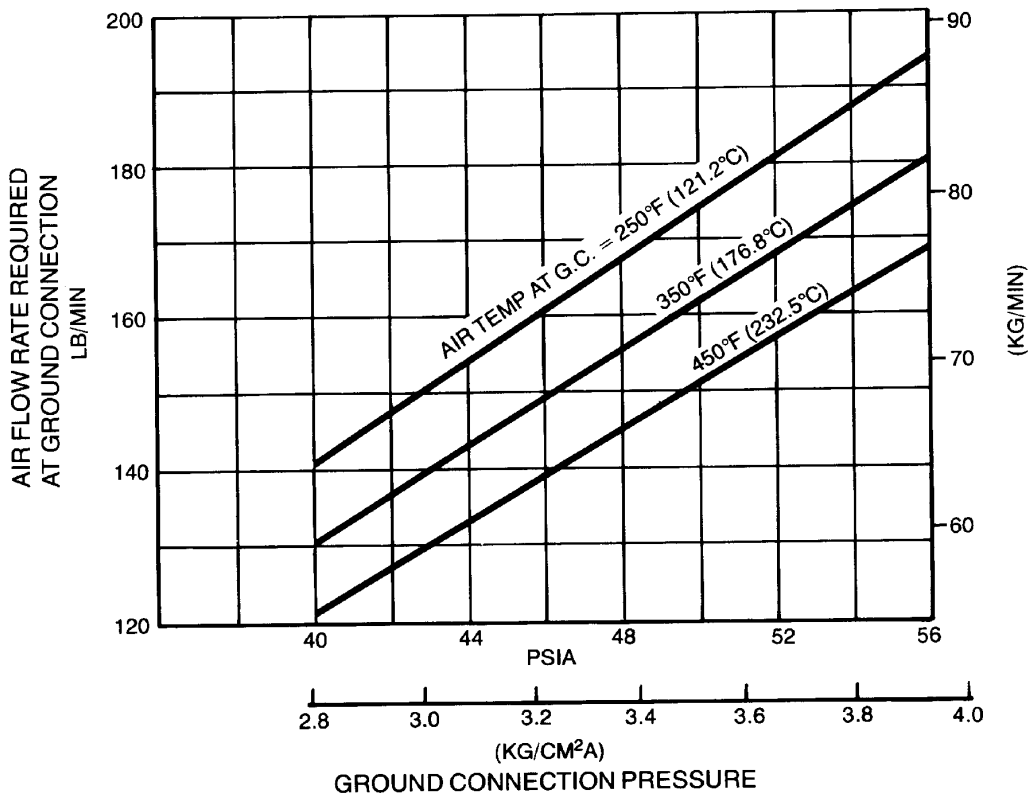

- FOR TWO ROYLYN GROUND CONNECTORS, DETERMINE PRESSURE AND AIR FLOW FROM CURVES, THEN INCREASE PRESSURE BY 5%
- CURVE VALUES WILL PROVIDE AT LEAST 20% N₂ PRESSURIZATION SPEED

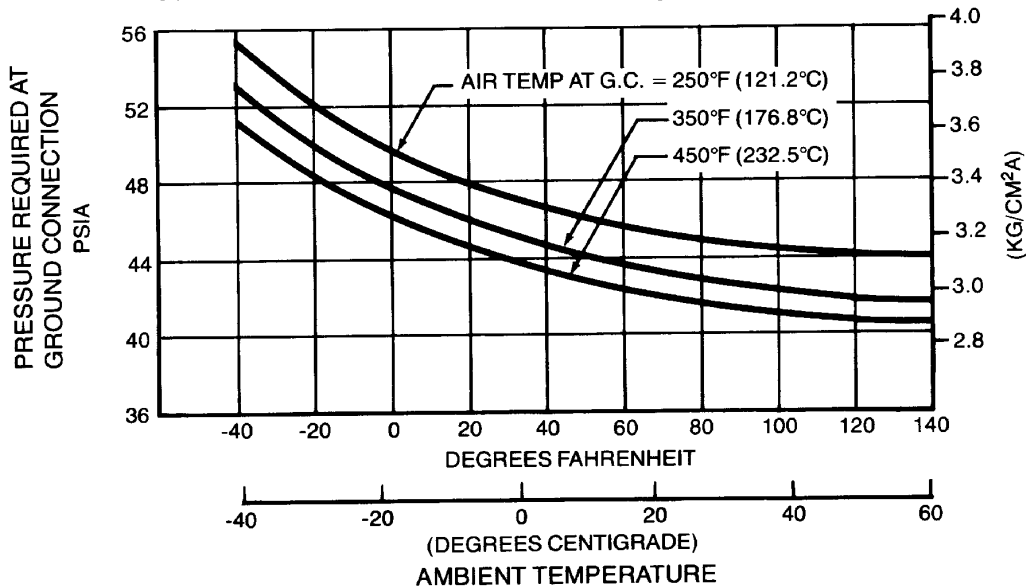

**5.5.4 ENGINE-STARTING PNEUMATIC REQUIREMENTS—SEA LEVEL—
AIRESEARCH STARTER—RB211-524 ENGINES
MODEL 747**

- NOTES:
- ESTIMATED AIR PRESSURES AND FLOWS REQUIRED AT AIRPLANE GROUND CONNECTION (G.C.) TO PROVIDE MINIMUM STARTING REQUIREMENTS
 - FOR TWO BOBRICK GROUND CONNECTORS ONLY (EXCEPT AS NOTED)
 - HAMILTON-STANDARD STARTER, MODEL PS600-3
 - RB211-524 SERIES ENGINES
 - COORDINATE WITH USING AIRLINE FOR SPECIFIC PLANNED OPERATING PROCEDURE

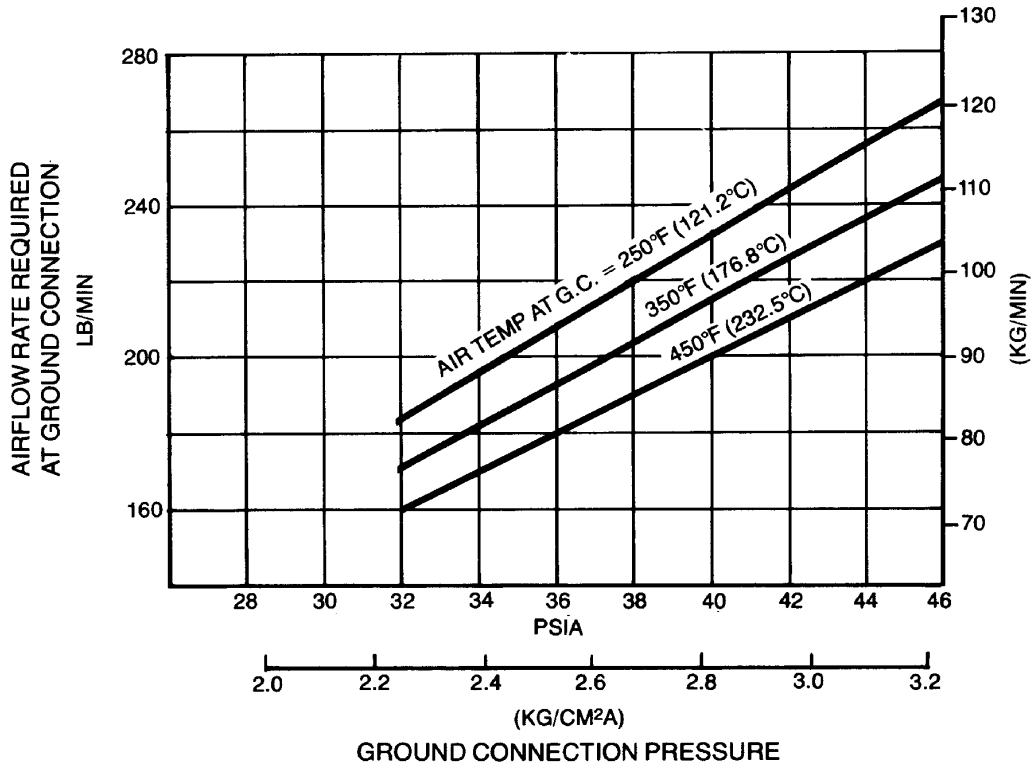

- FOR TWO ROYLYN GROUND CONNECTORS, DETERMINE PRESSURE AND AIR FLOW FROM CURVES, THEN INCREASE PRESSURE BY 5%
- CURVE VALUE WILL PROVIDE AT LEAST 20% N₃ PRESSURIZATION SPEED

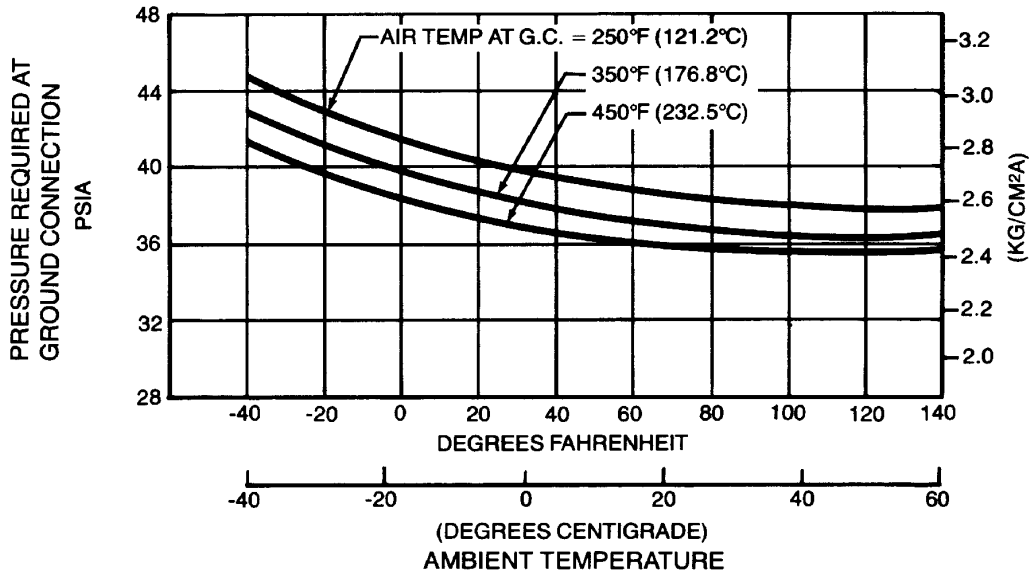

**5.5.5 ENGINE-STARTING PNEUMATIC REQUIREMENTS—SEA LEVEL—
HAMILTON-STANDARD STARTER—RB211-524 ENGINES
MODEL 747**

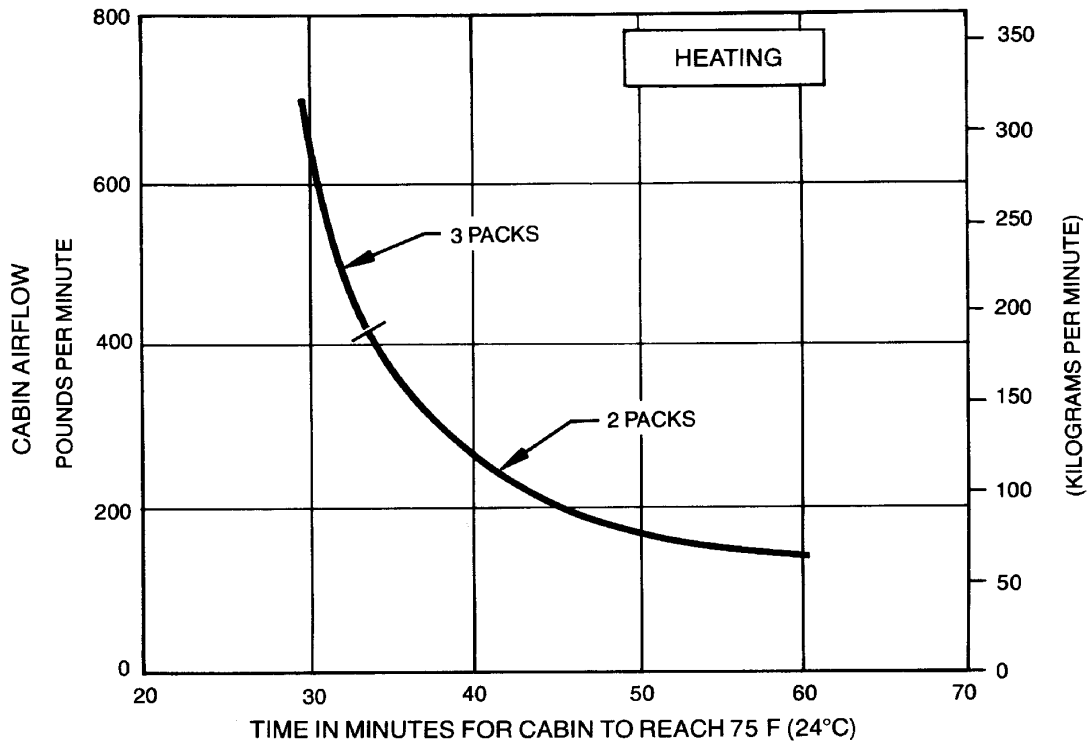

- NOTES:
- AMBIENT AND INITIAL CABIN TEMP. -25°F (-32°C)
 - NO PASSENGERS
 - PACK OUTLET TEMP. 160°F (71°C)
 - DOORS CLOSED
 - RECIRCULATING FANS OFF
 - NO GALLEY LOAD
 - NO LIGHTING LOAD

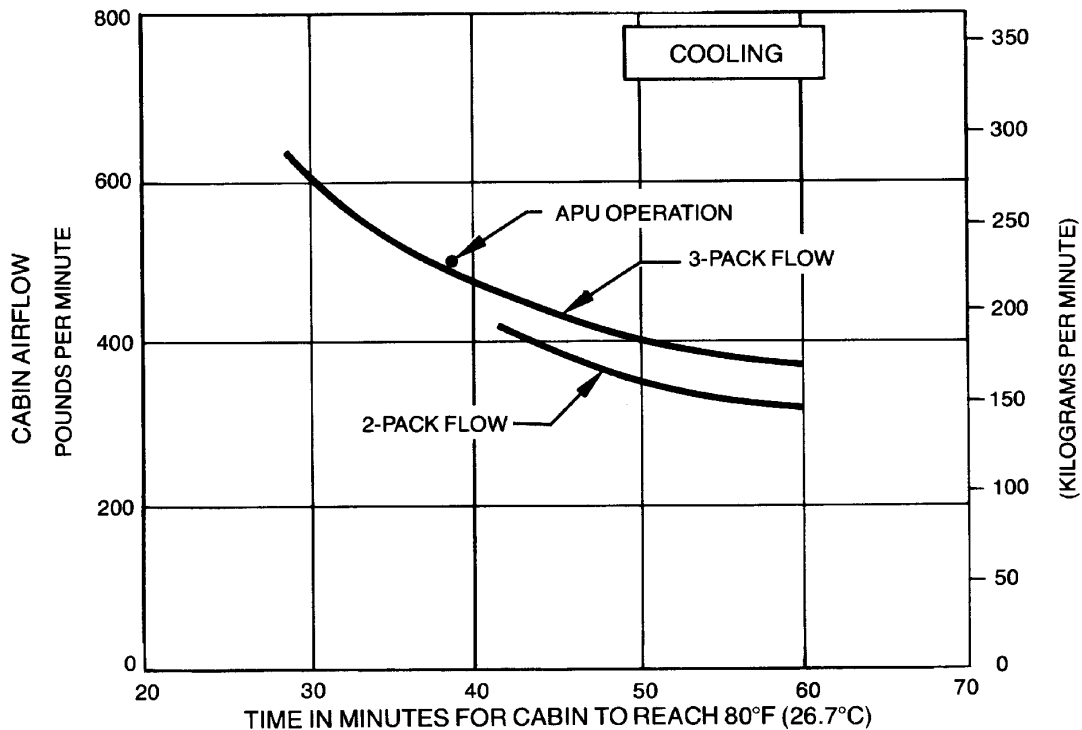

- NOTES:
- INITIAL CABIN TEMP. AT 115°F (46.1°C)
 - NO PASSENGERS
 - OUTSIDE AIR TEMP. AT 100°F (37.8°C)
 - DOORS CLOSED
 - TEMP. AT GROUND CONNECTION 400°F (204.4°C)
 - NO GALLEY LOAD
 - NO LIGHTING LOAD

5.6.1 GROUND PNEUMATIC POWER REQUIREMENTS — HEATING/COOLING
MODELS 747-100B, -200B, -200C, -300 (PASSENGER CONFIGURATIONS)

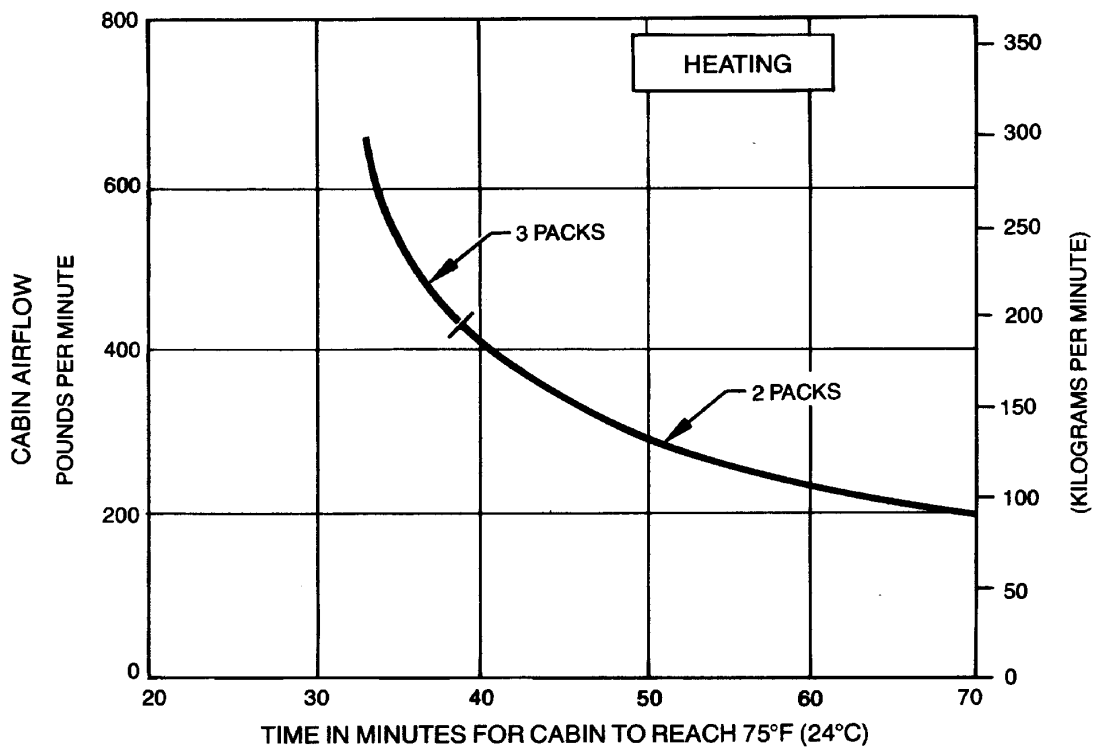

NOTES:

- AMBIENT AND INITIAL CABIN TEMP. -25 F (-32°C)
- PACK OUTLET TEMP. 160°F (71°C)
- RECIRCULATING FANS OFF
- DOORS CLOSED

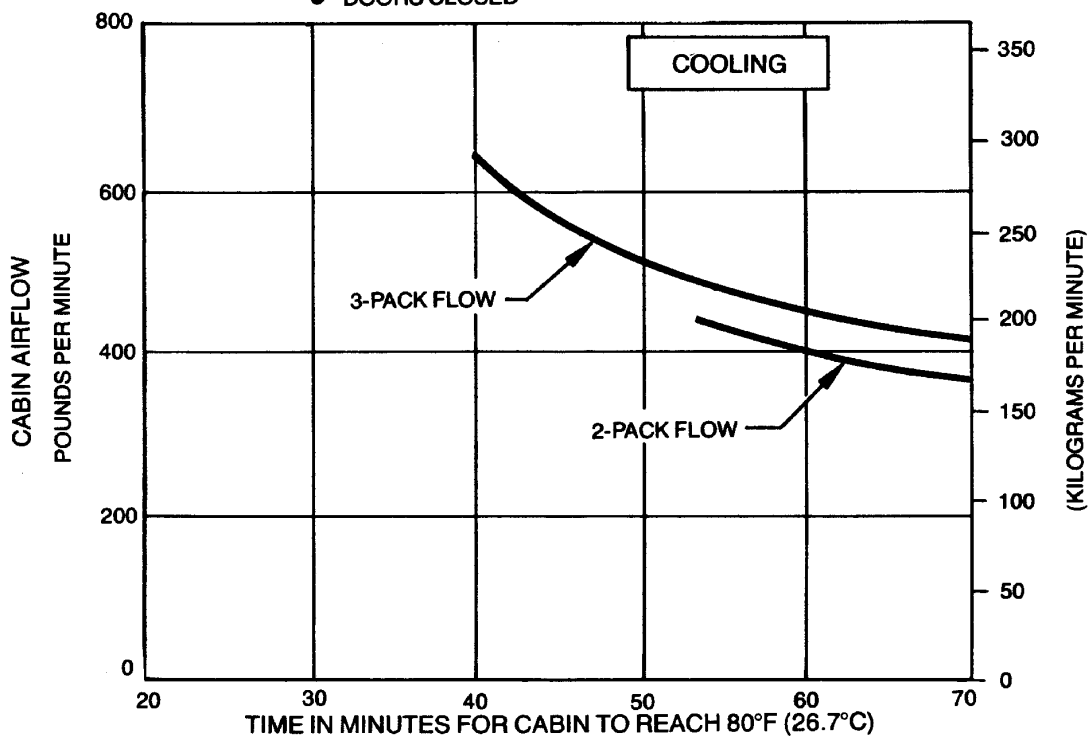

NOTES:

- INITIAL CABIN TEMP. AT 115°F (46.1°C)
- OUTSIDE AIR TEMP. AT 100°F (37.8°C)
- TEMP. AT GROUND CONNECTION 400°F (204.4°C)
- DOORS CLOSED

**5.6.2 GROUND PNEUMATIC POWER REQUIREMENTS — HEATING/COOLING
MODELS 747-100SF, -200F, -200C (CARGO CONFIGURATIONS)**

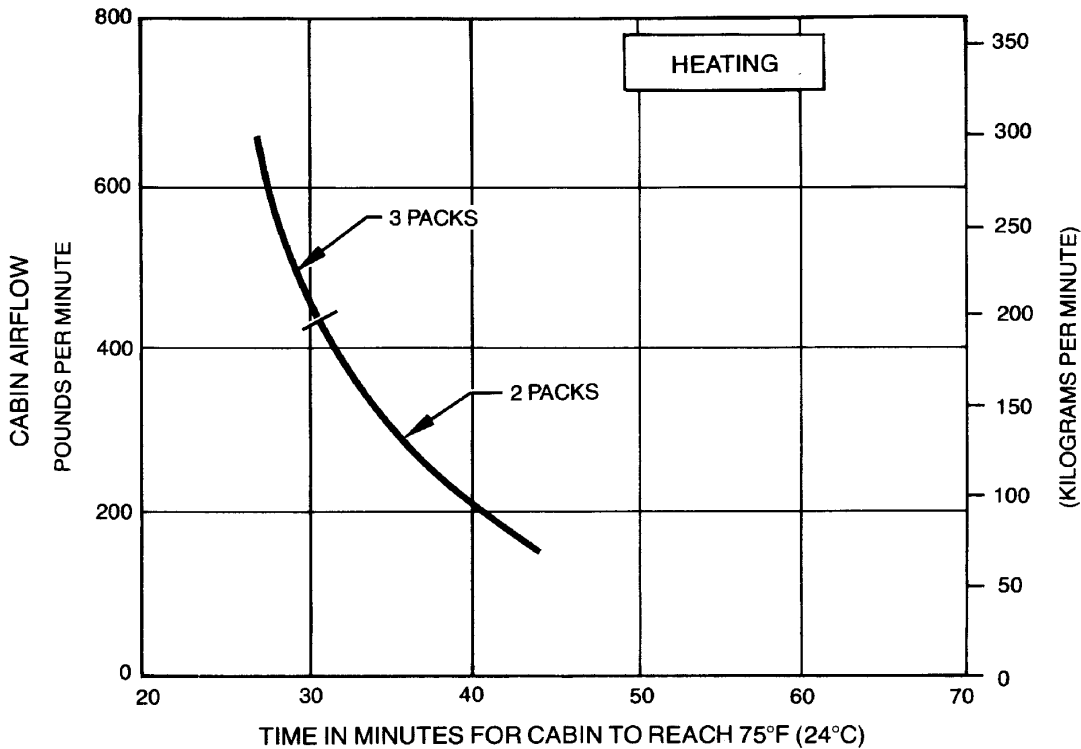

- NOTES:
- AMBIENT AND INITIAL CABIN TEMP. -25°F (-32°C)
 - PACK OUTLET TEMP. 160°F (71°C)
 - RECIRCULATING FANS OFF
 - NO PASSENGERS
 - DOORS CLOSED
 - NO GALLEY LOAD
 - NO LIGHTING LOAD

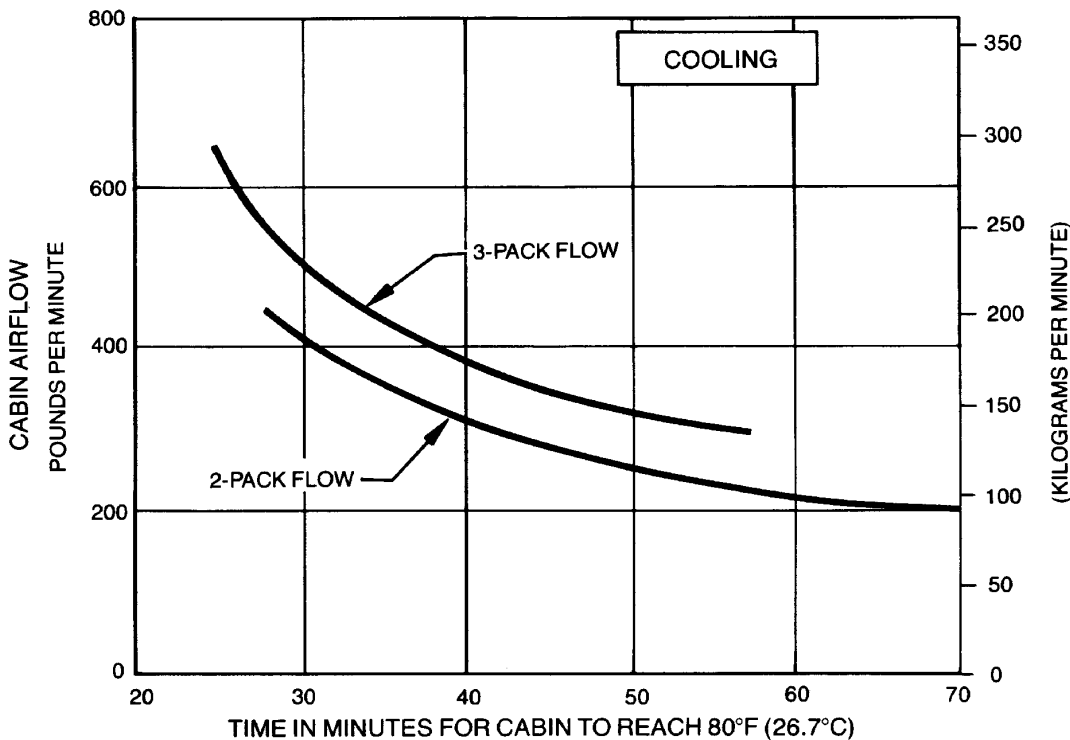

- NOTES:
- INITIAL CABIN TEMP. AT 115°F (46.1°C)
 - OUTSIDE AIR TEMP. AT 100°F (37.8°C)
 - TEMP. AT GROUND CONNECTION 400°F (204.4°C)
 - NO PASSENGERS
 - DOORS CLOSED
 - NO GALLEY LOAD
 - NO LIGHTING LOAD

5.6.3 GROUND PNEUMATIC POWER REQUIREMENTS — HEATING/COOLING MODEL 747SP

CONDITIONS:

ALL DOOR AND HATCHES CLOSED

① 75°F (23.9°C) CABIN TEMP., 511 OCCUPANTS; 28,000 BTU/HR (7,050 KG CAL/HR) SOLAR LOAD AND 75,000 BTU/HR (18,900 KG CAL/HR) ELECTRICAL LOAD.

② 80°F (26.7°C) CABIN TEMP., HEAT LOADS SAME AS ① ABOVE

③ 75°F (23.9°C) CABIN TEMP., 3 OCCUPANTS, 28,000 BTU/HR (7,050 KG CAL/HR) SOLAR LOAD

④ 80°F (26.7°C) CABIN TEMP., HEAT LOADS SAME AS ③ ABOVE

⑤ ⑥ & ⑦ 75°F (23.9°C) CABIN TEMP., NO OCCUPANTS OR HEAT LOADS.

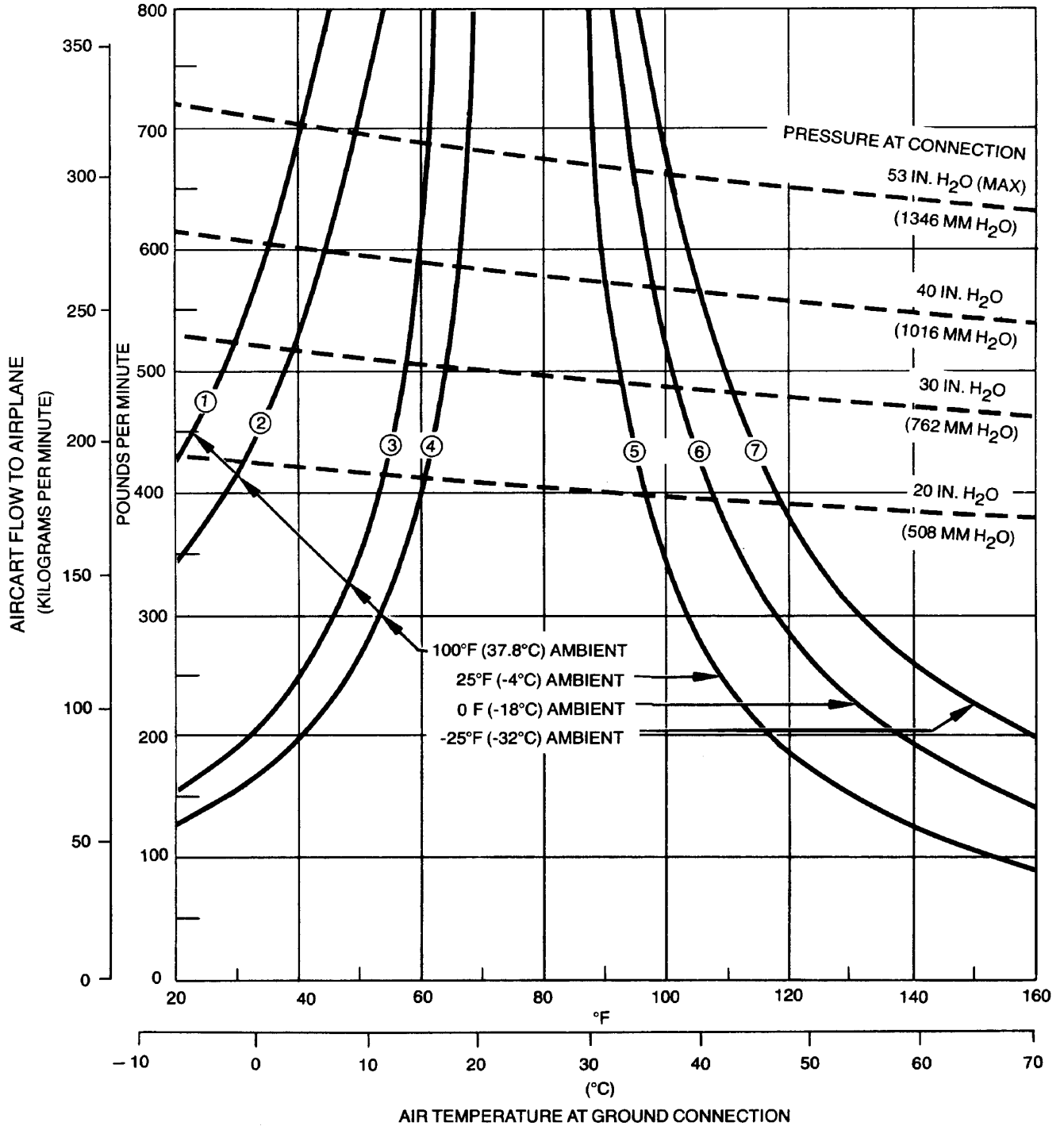

5.7.1 CONDITIONED AIR FLOW REQUIREMENTS
MODELS 747-100B, -200B, -200C, -300 (PASSENGER CONFIGURATIONS)

CONDITIONS:

- ① 75°F (23.9°C) CABIN TEMP., 3 OCCUPANTS; 4,200 BTU/HR (1,060 KG CAL/HR) SOLAR LOAD AND 15,000 BTU/HR (3,780 KG CAL/HR) ELECTRICAL LOAD AND 100°F (37.8°C) AMBIENT TEMPERATURE
- ② 80°F (26.7°C) CABIN TEMP., HEAT LOADS SAME AS ① ABOVE
- ③ 75°F (23.9°C) CABIN TEMP., NO HEAT LOADS, 25°F (-4°C) AMBIENT
- ④ SAME AS ③ EXCEPT 0°F (-18°C) AMBIENT
- ⑤ SAME AS ③ EXCEPT -25°F (-32°C) AMBIENT

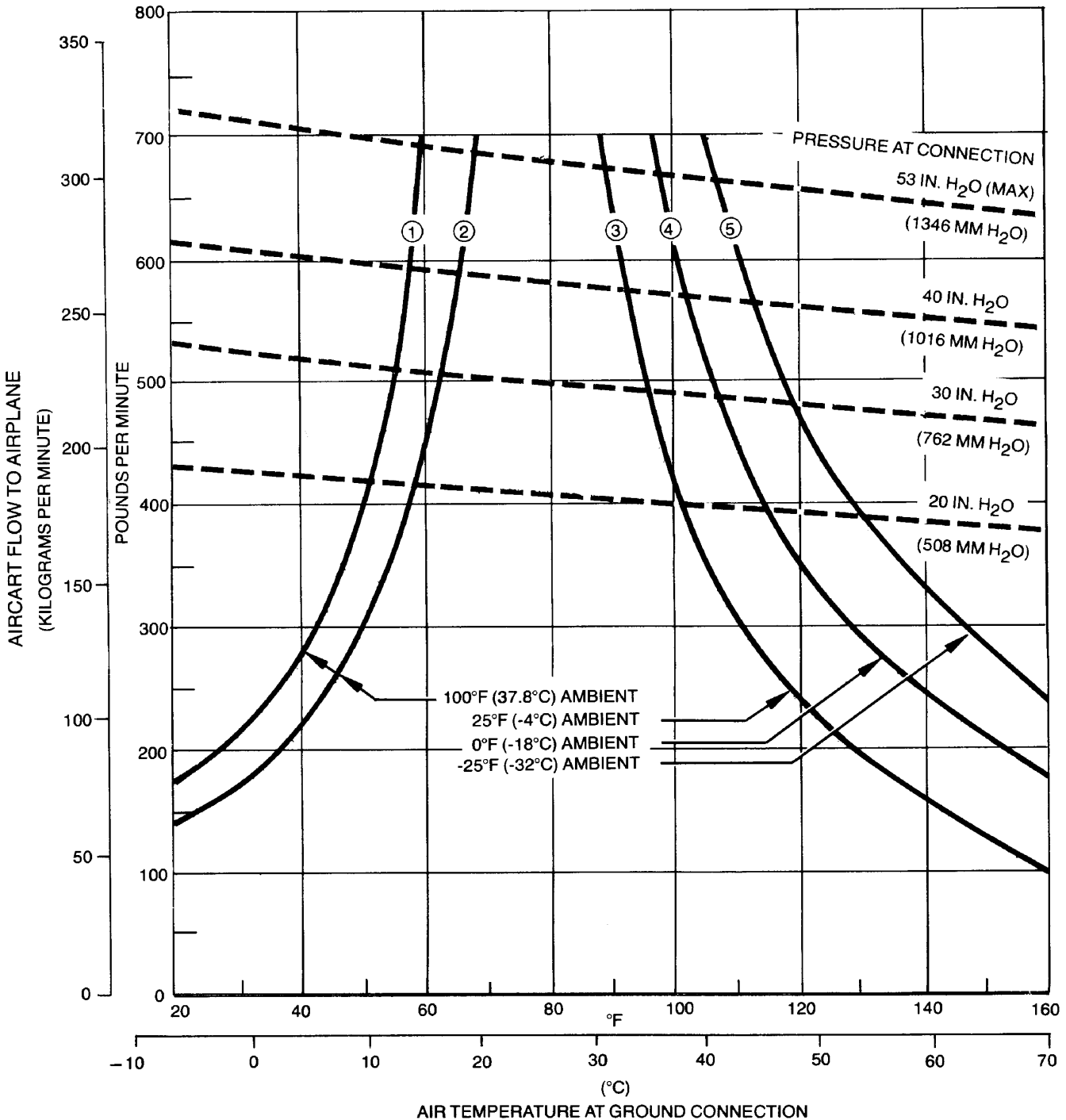

5.7.2 CONDITIONED AIR FLOW REQUIREMENTS
MODELS 747-100SF, 200C, 200F (CARGO CONFIGURATIONS)

CONDITIONS:

ALL DOOR AND HATCHES CLOSED

① 75°F (23.9°C) CABIN TEMP, 322 OCCUPANTS; 19,000 BTU/HR (4,790 KG CAL/HR) SOLAR LOAD AND 60,000 BTU/HR (15,120 KG CAL/HR) ELECTRICAL LOAD.

② 80°F (26.7°C) CABIN TEMP, HEAT LOADS SAME AS 1, ABOVE.

③ 75°F (23.9°C) CABIN TEMP, 3 OCCUPANTS, 19,000 BTU/HR (4,790 KG CAL/HR) SOLAR LOAD.

④ 80°F (26.7°C) CABIN TEMP, HEAT LOADS SAME AS 3, ABOVE.

⑤ ⑥ & ⑦ 75°F (23.9°C) CABIN TEMP., NO OCCUPANTS OR HEAT LOADS.

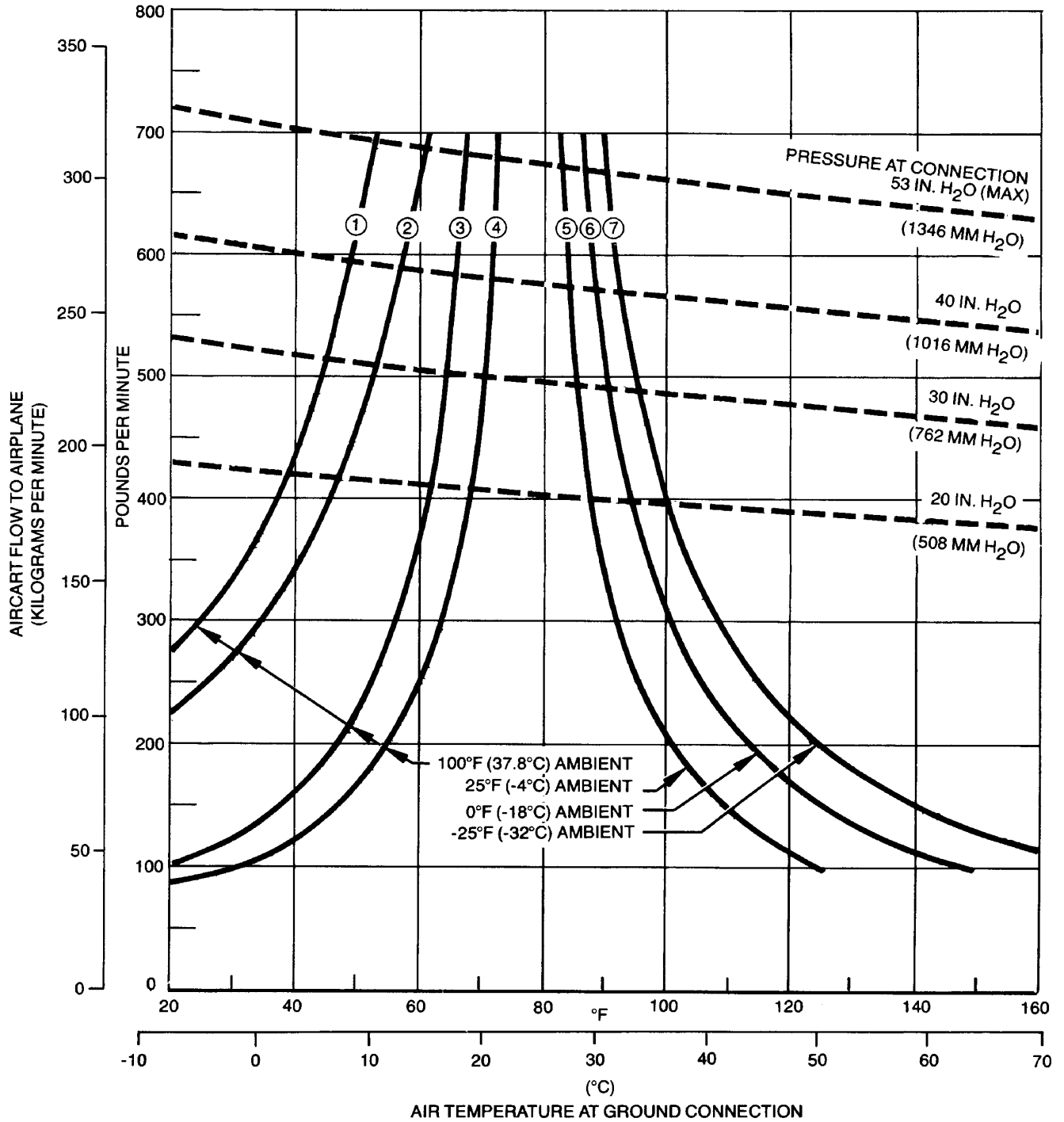

**5.7.3 CONDITIONED AIR FLOW REQUIREMENTS
MODEL 747SP**

5.8 Ground Towing Requirements

Ground towing requirements for various towing conditions are presented on the following pages.

Drawbar pull and total traction wheel load may be determined by considering airplane weight, pavement slope, coefficient of friction, and engine idle thrust.

EXAMPLE:

In the examples shown, airplane weight is assumed to be 445,000 lb (202,000 kg).

Towing on wet concrete (line A) against a 1% slope with no engine thrust requires a drawbar pull of 22,000 lb (10,000 kg) and a total traction wheel load of 38,000 lb (17,200 kg).

When the airplane is backed against four-engine idle thrust and a 1% slope on wet concrete (line B), the required drawbar pull is 28,200 lb (12,800 kg) and required total traction wheel load is 49,000 lb (22,300 kg).

- NOTES: 1. UNUSUAL BREAKAWAY CONDITIONS NOT SHOWN.
 2. STRAIGHT-LINE TOW.
 3. COEFFICIENTS OF FRICTION (μ) ARE ESTIMATED FOR RUBBER-TIRED TOW VEHICLES.
 4. FOR TOWING DATA RELATED TO TURNING, SEE SEC. 4.2.

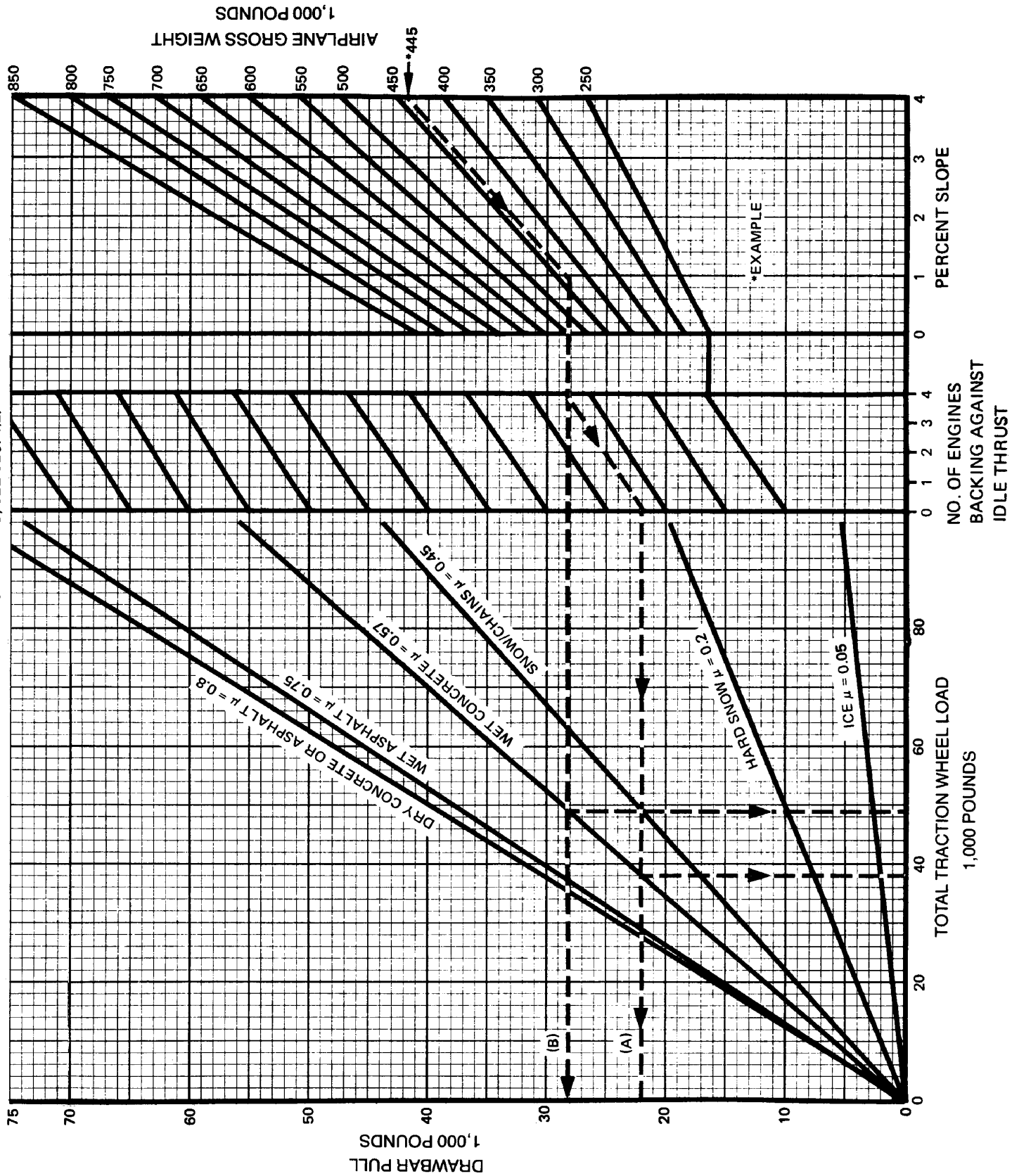

5.8.1 GROUND TOWING REQUIREMENTS — ENGLISH UNITS
MODEL 747

- NOTES: 1. UNUSUAL BREAKAWAY CONDITIONS NOT SHOWN
 2. STRAIGHT-LINE TOW
 3. COEFFICIENTS OF FRICTION (μ) ARE ESTIMATED FOR RUBBER-TIRED TOW VEHICLES.
 4. FOR TOWING DATA RELATED TO TURNING, SEE SEC. 4.2.

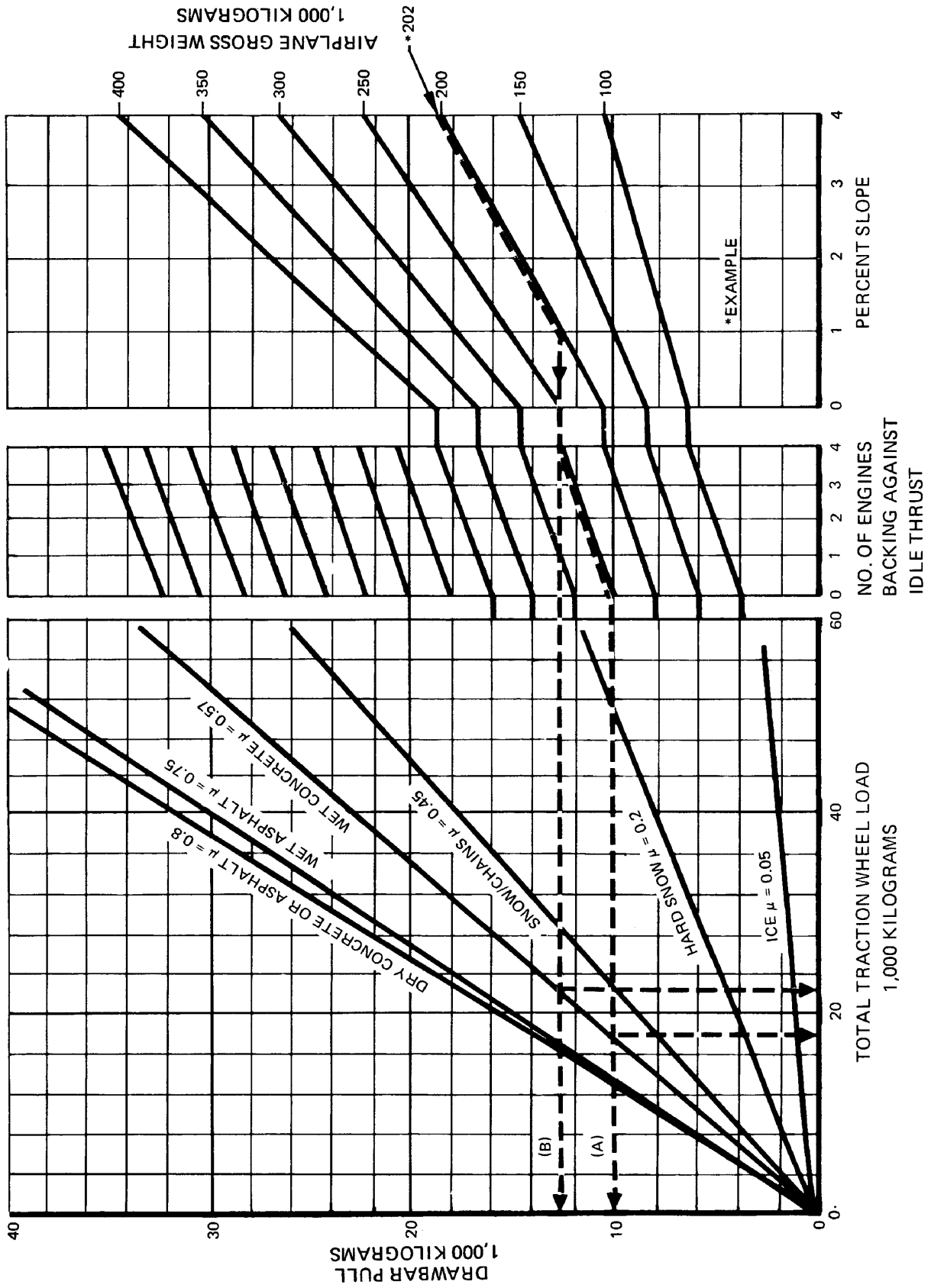

5.8.2 GROUND TOWING REQUIREMENTS — METRIC UNITS
MODEL 747

6.0 JET ENGINE WAKE AND NOISE DATA

6.1 Jet Engine Exhaust Velocities and Temperatures

6.2 Airport and Community Noise

6.0 JET ENGINE WAKE AND NOISE DATA

6.1 Jet Engine Exhaust Velocities and Temperatures

This section shows exhaust velocity and temperature contours aft of the 747. The contours were calculated from a standard computer analysis using three-dimensional viscous flow equations with mixing of primary, fan, and free-stream flow. The presence of the ground plane is included in the calculations as well as engine tilt and toe-in. Mixing of flows from the engines is calculated. The analysis does not include thermal buoyancy effects which tend to elevate the jet wake above the ground plane. The buoyancy effects are considered to be small relative to the lateral velocity and therefore are not included.

The graphs show jet wake velocity and temperature contours for representative engine types. The results are valid for sea level, static, standard-day conditions, without wind. The effect of wind on jet wakes was not included. There is evidence to show that a downwind or an upwind component does not simply add or subtract from the jet wake velocity, but rather carries the whole envelope in the direction of the wind. Cross winds may carry the jet wake contour far to the side at large distances behind the airplane.

Data in this section represent four engine settings; takeoff, high breakaway, low breakaway, and ground idle. Thrust settings are approximately 50,000 lb (27,700 kg), 11,000 lb (5,000 kg), 6,000 lb (2,700 kg), and 2,000 lb (900 kg) respectively.

NOTES:

- ENGINE TYPE JT9D-3, BLOCK II (SAME NOZZLE AS -7)
- DATA ARE APPLICABLE TO JT9D-7 ENGINE
- TEST 25-3
- TEST SITE ELEV. 1186 FT (362 M)
- AMBIENT AIR TEMP. 50°F (10°C)
- HEADWINDS LESS THAN 6 MPH (9.6 KMPH)

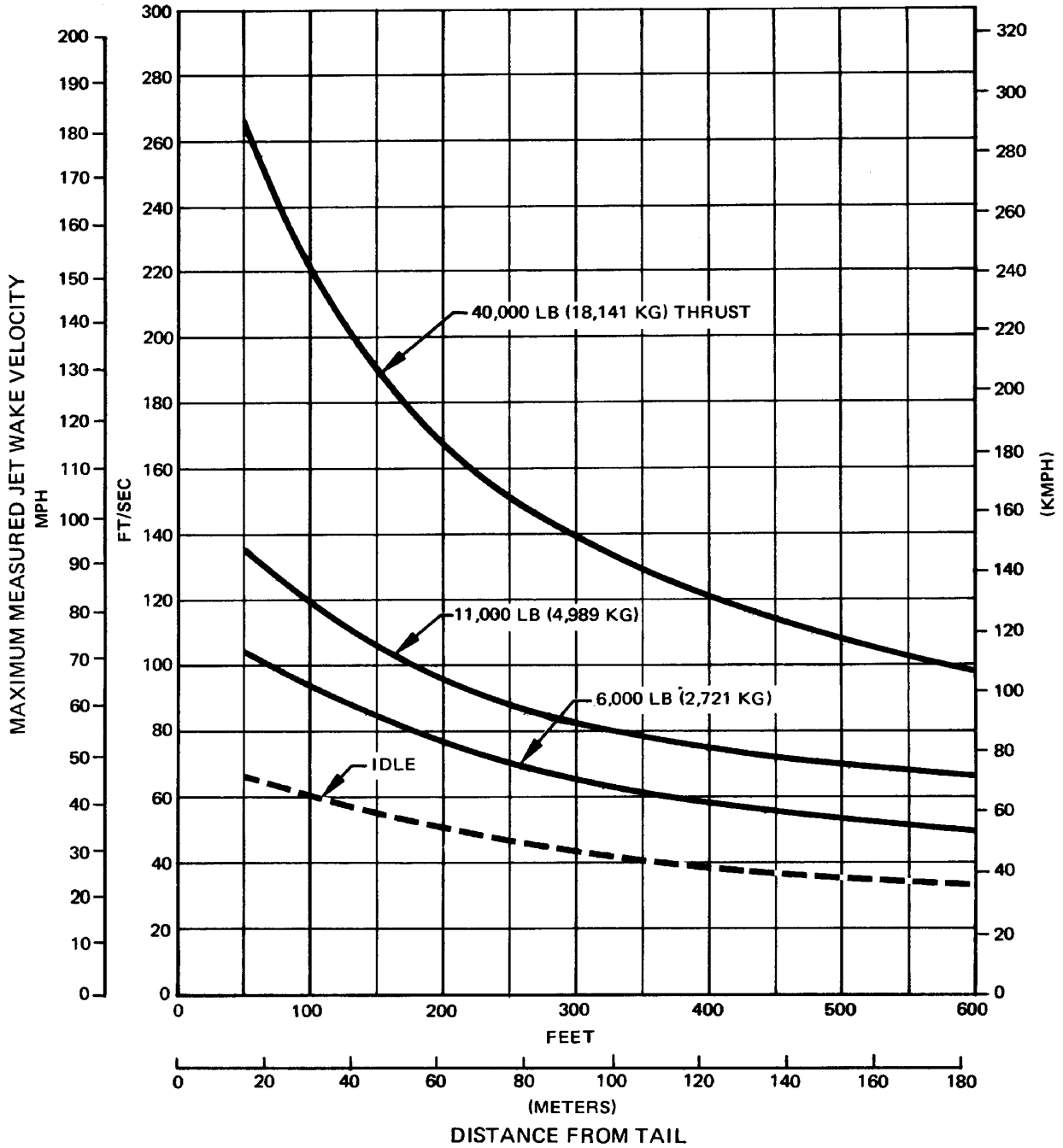

**6.1.1 MAXIMUM MEASURED JET WAKE VELOCITY (JT9D-3, BLK II)
MODEL 747**

- NOTES:
- ENGINE THRUST, IDLE SETTING 2,000 POUNDS (900 KILOGRAMS) NOMINAL
 - CONTOURS CALCULATED FROM COMPUTER DATA
 - STANDARD DAY
 - SEA LEVEL
 - NEGLIGIBLE WIND
 - FOR 747SP EXHAUST CONTOUR LENGTHS, ADD 30 FEET (9.14 METERS)

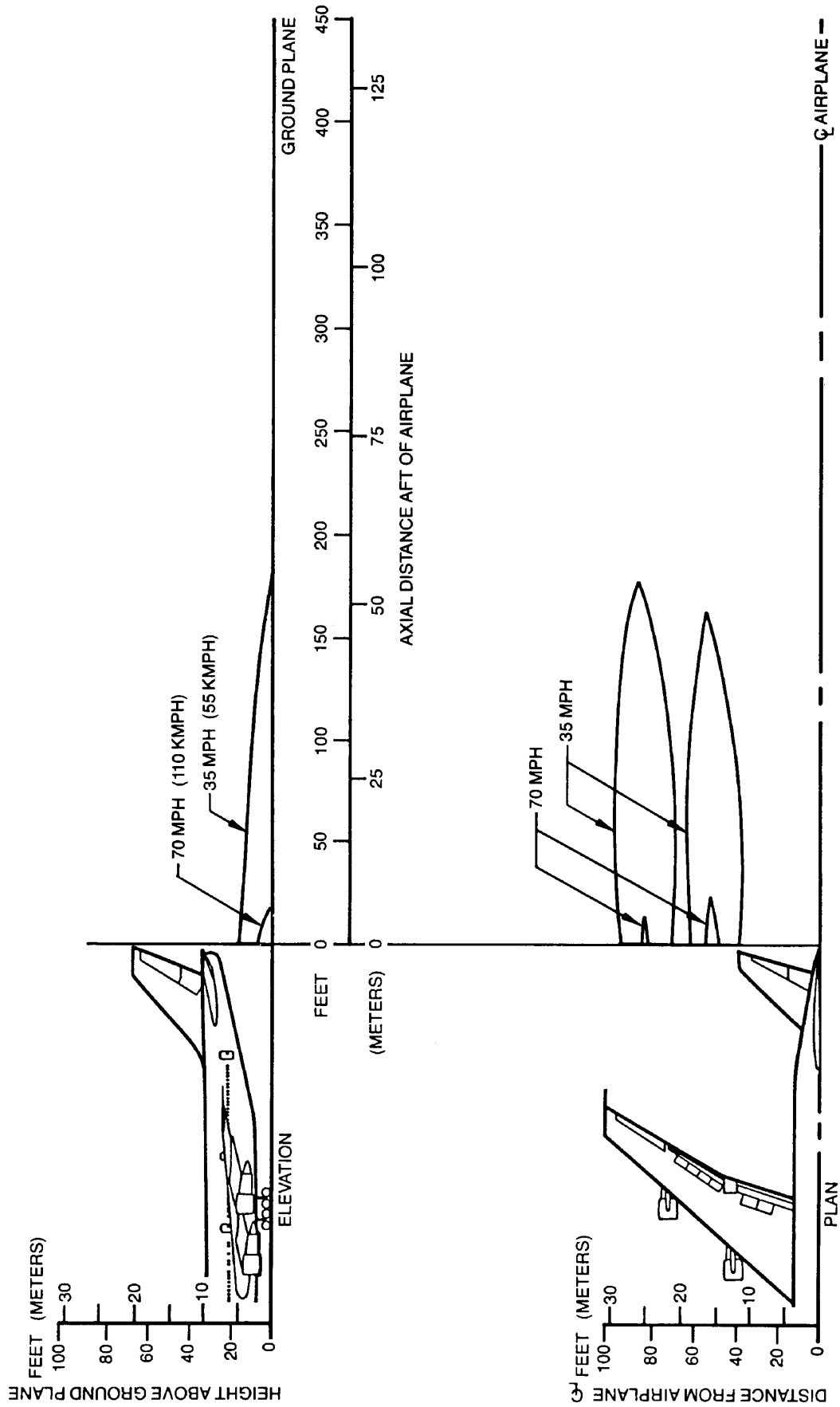

6.1.2 JET ENGINE EXHAUST VELOCITY CONTOURS - IDLE THRUST MODEL 747

- NOTES:
- ENGINE THRUST, LOW BREAKAWAY, 6,000 POUNDS (2,700 KILOGRAMS) NOMINAL
 - CONTOURS CALCULATED FROM COMPUTER DATA
 - STANDARD DAY
 - SEA LEVEL
 - NEGLIGIBLE WIND
 - FOR 747SP EXHAUST CONTOUR LENGTHS, ADD 30 FEET (9.14 METERS)

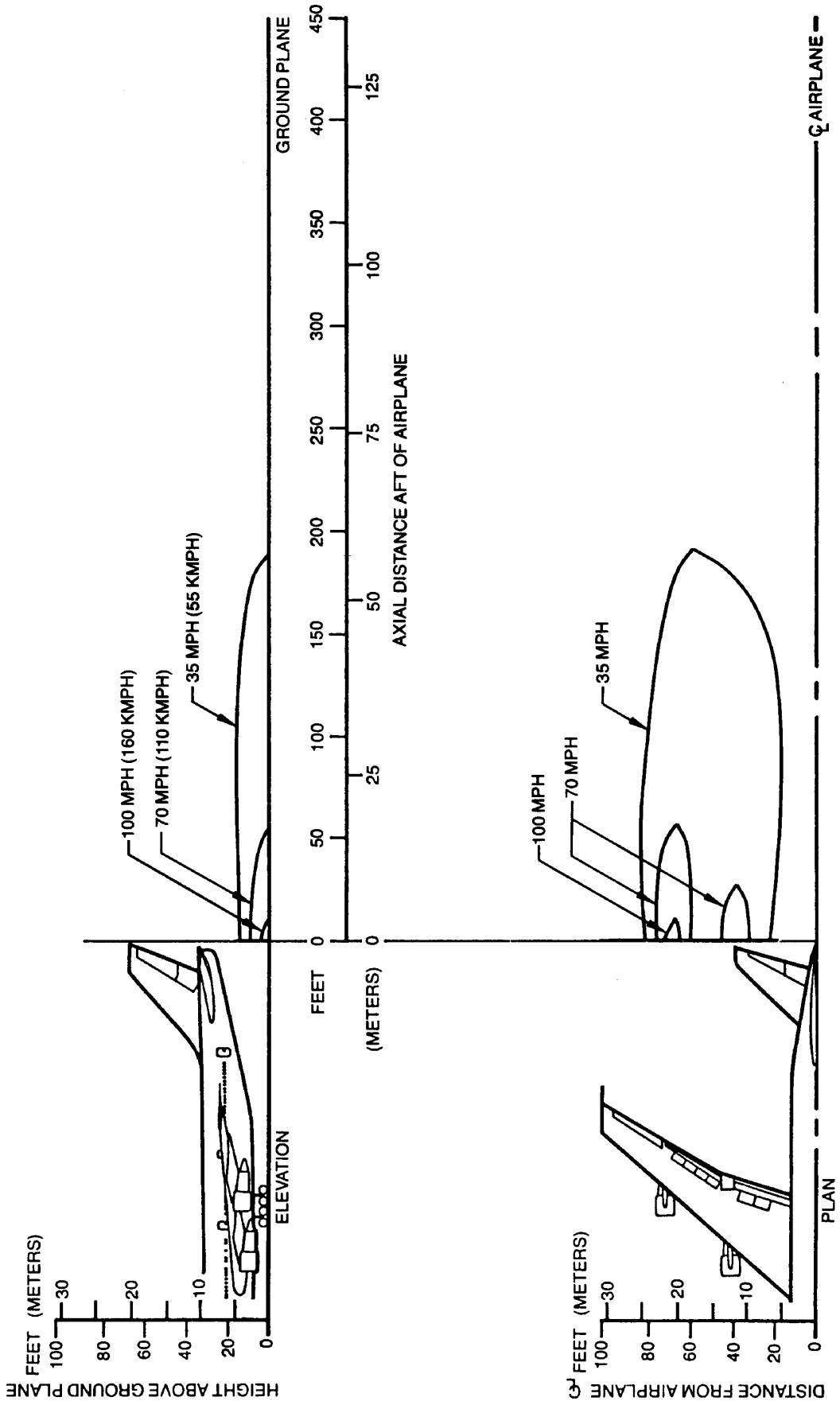

6.1.3 JET ENGINE EXHAUST VELOCITY CONTOURS - LOW BREAKAWAY THRUST MODEL 747

- NOTES:
- ENGINE THRUST, HIGH BREAKAWAY, 11,000 POUNDS (5,000 KILOGRAMS) NOMINAL
 - CONTOURS CALCULATED FROM COMPUTER DATA
 - STANDARD DAY
 - SEA LEVEL
 - NEGLIGIBLE WIND
 - FOR 747SP EXHAUST CONTOUR LENGTHS, ADD 30 FEET (9.14 METERS)

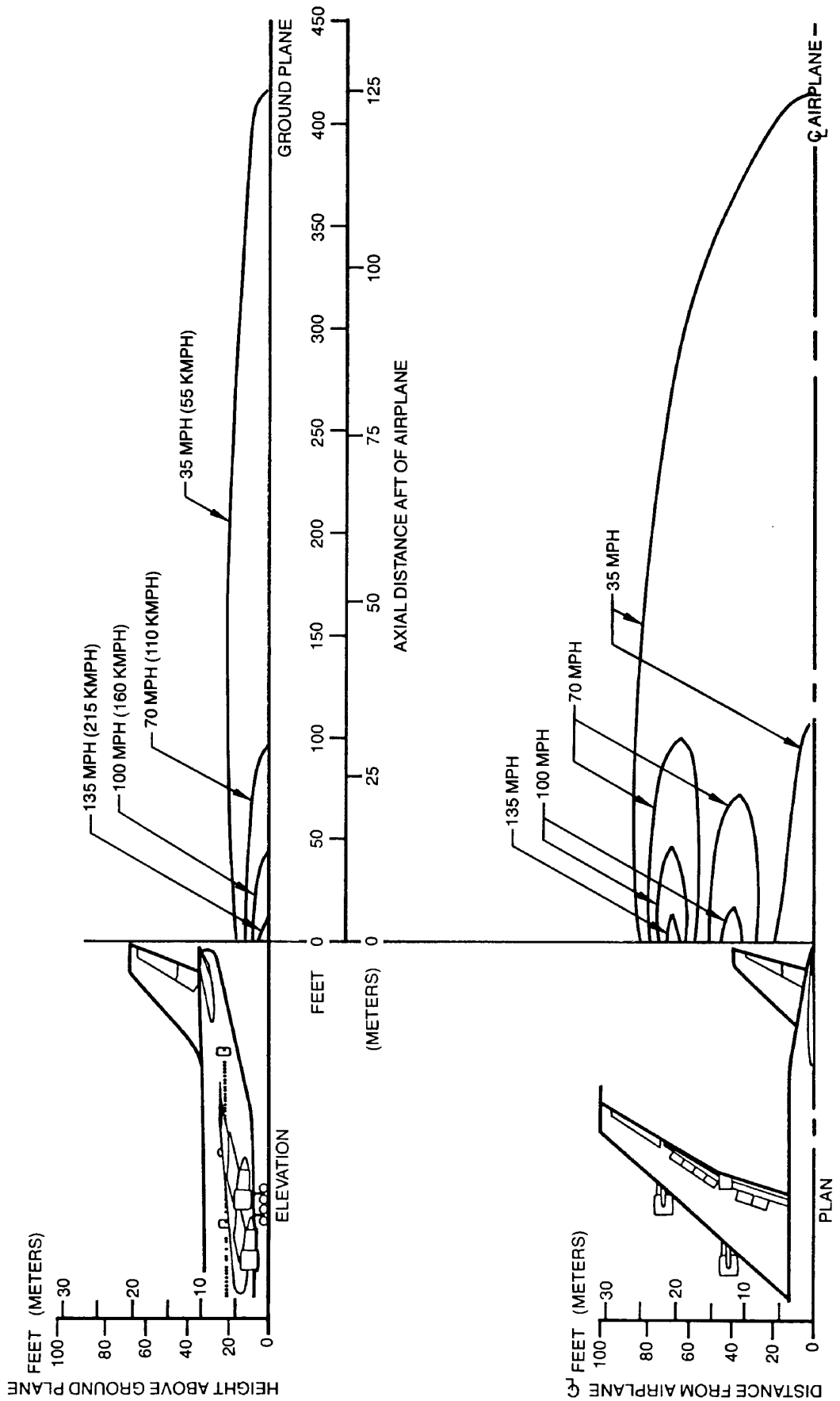

6.1.4 JET ENGINE EXHAUST VELOCITY CONTOURS - HIGH BREAKAWAY THRUST
MODEL 747

- NOTES:
- ENGINE THRUST, TAKEOFF SETTING, 50,000 POUNDS (22,700 KILOGRAMS) NOMINAL
 - CONTOURS CALCULATED FROM COMPUTER DATA
 - STANDARD DAY
 - SEA LEVEL
 - NEGLIGIBLE WIND
 - FOR 747SP EXHAUST CONTOUR LENGTHS, ADD 30 FEET (9.14 METERS)

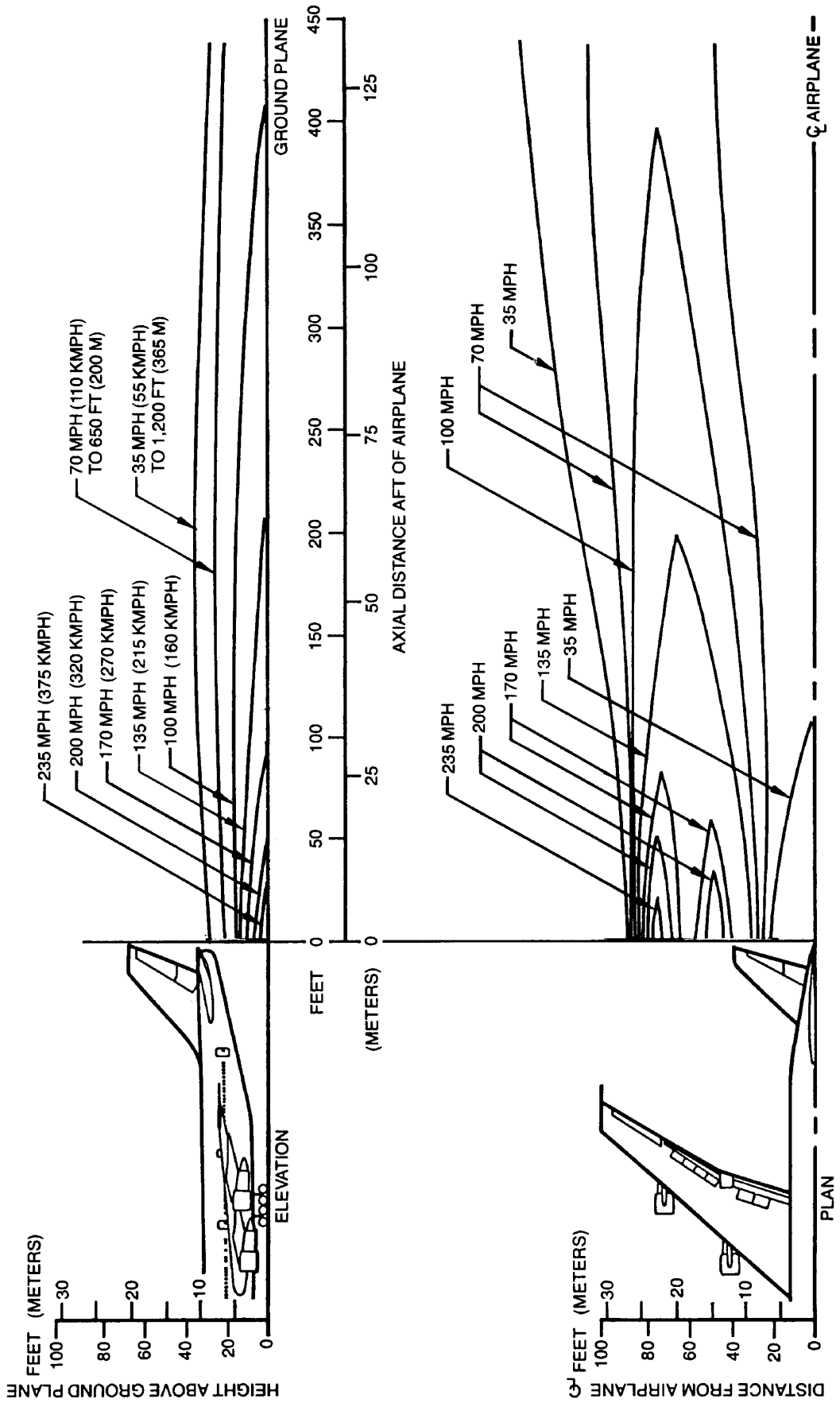

**6.1.5 JET ENGINE EXHAUST VELOCITY CONTOURS - TAKEOFF THRUST
MODEL 747**

- NOTES:
- ENGINE THRUST, IDLE SETTING, 2,000 POUNDS (900 KILOGRAMS) NOMINAL
 - CONTOURS CALCULATED FROM COMPUTER DATA
 - STANDARD DAY
 - SEA LEVEL
 - NEGLIGIBLE WIND
 - FOR 747SP EXHAUST CONTOUR LENGTHS, ADD 30 FEET (9.14 METERS)

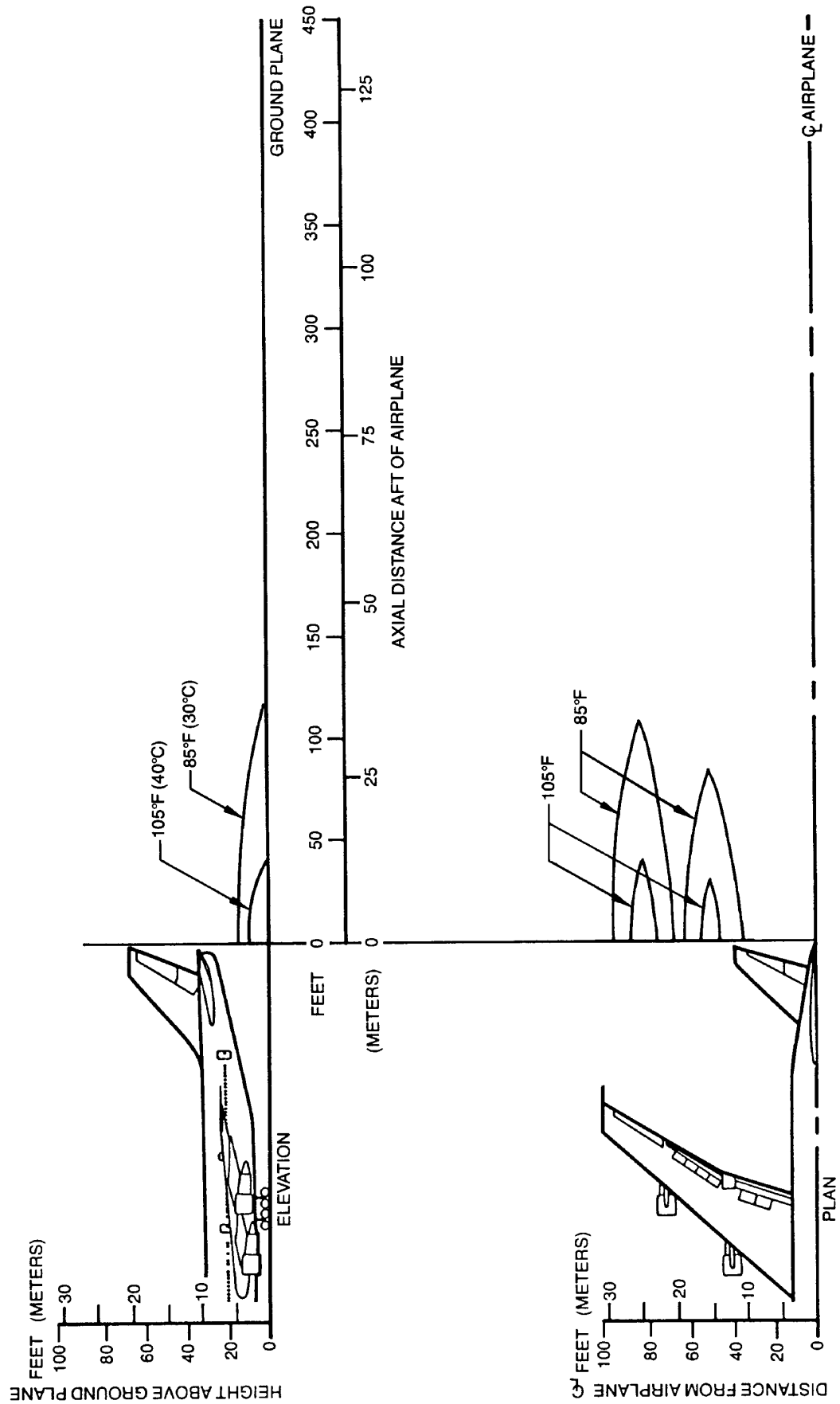

6.1.6 JET ENGINE EXHAUST TEMPERATURE CONTOURS - IDLE THRUST MODEL 747

- NOTES:
- ENGINE THRUST, LOW BREAKAWAY, 6,000 POUNDS (2,700 KILOGRAMS) NOMINAL
 - CONTOURS CALCULATED FROM COMPUTER DATA
 - STANDARD DAY
 - SEA LEVEL
 - NEGLIGIBLE WIND
 - FOR 747SP EXHAUST CONTOUR LENGTHS, ADD 30 FEET (9.14 METERS)

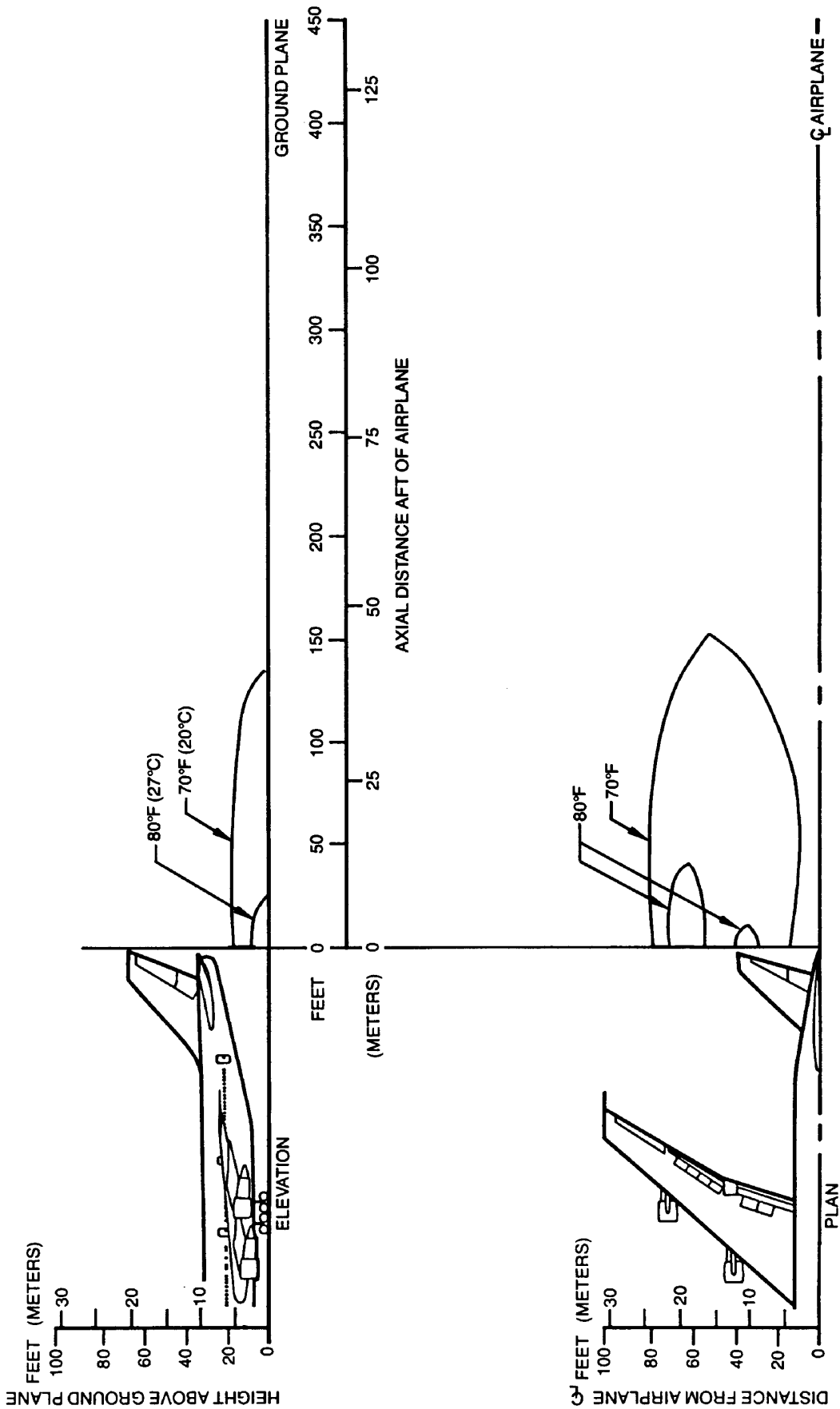

**6.1.7 JET ENGINE EXHAUST TEMPERATURE CONTOURS - LOW BREAKAWAY THRUST
MODEL 747**

- NOTES:
- ENGINE THRUST, HIGH BREAKAWAY, 11,000 POUNDS (5,000 KILOGRAMS) NOMINAL
 - CONTOURS CALCULATED FROM COMPUTER DATA
 - STANDARD DAY
 - SEA LEVEL
 - NEGLIGIBLE WIND
 - FOR 747SP EXHAUST CONTOUR LENGTHS, ADD 30 FEET (9.14 METERS)

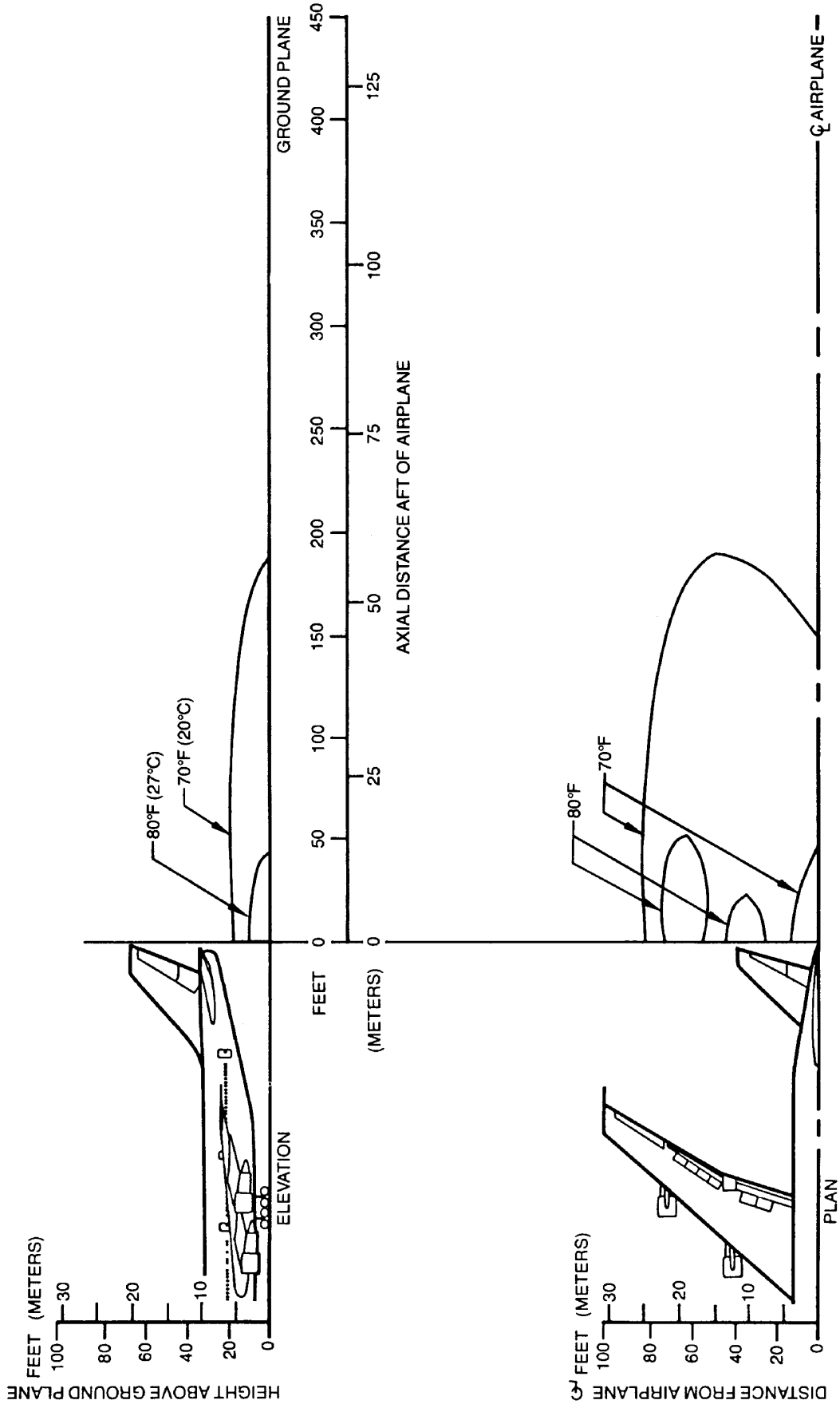

**6.1.8 JET ENGINE EXHAUST TEMPERATURE CONTOURS - HIGH BREAKAWAY THRUST
MODEL 747**

- NOTES:
- ENGINE THRUST, TAKEOFF SETTING, 50,000 POUNDS (22,700 KILOGRAMS) NOMINAL
 - CONTOURS CALCULATED FROM COMPUTER DATA
 - STANDARD DAY
 - SEA LEVEL
 - NEGLIGIBLE WIND
 - FOR 747SP EXHAUST CONTOUR LENGTHS, ADD 30 FEET (9.14 METERS)

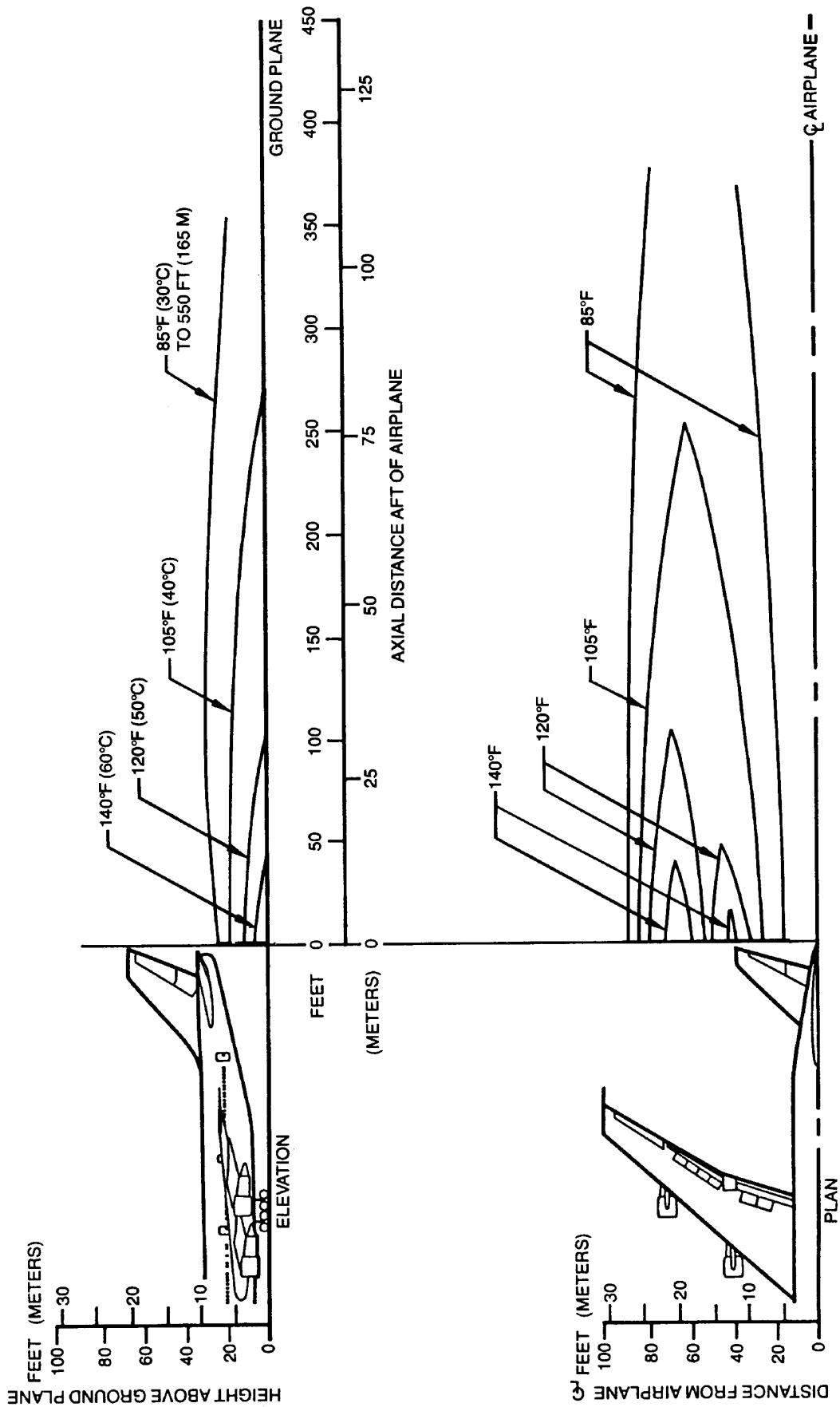

6.1.9 JET ENGINE EXHAUST TEMPERATURE CONTOURS - TAKEOFF THRUST MODEL 747

6.2 Airport and Community Noise

Airport noise is of major concern to the airport and community planner. The airport is a major element in the community's transportation system and, as such, is vital to its growth. However, the airport must also be a good neighbor, and this can be accomplished only with proper planning. Since aircraft noise extends beyond the boundaries of the airport, it is vital to consider the impact on surrounding communities. Many means have been devised to provide the planner with a tool to estimate the impact of airport operations. Too often they oversimplify noise to the point where the results become erroneous. Noise is not a simple subject; therefore, there are no simple answers.

The cumulative noise contour is an effective tool. However, care must be exercised to ensure that the contours, used correctly, estimate the noise resulting from aircraft operations conducted at an airport.

The size and shape of the single-event contours, which are inputs into the cumulative noise contours, are dependent upon numerous factors. They include the following:

1. Operational Factors
 - (a) Aircraft Weight-Aircraft weight is dependent on distance to be traveled, en route winds, payload, and anticipated aircraft delay upon reaching the destination.
 - (b) Engine Power Settings-The rates of ascent and descent and the noise levels emitted at the source are influenced by the power setting used.
 - (c) Airport Altitude-Higher airport altitude will affect engine performance and thus can influence noise.

2. Atmospheric Conditions-Sound Propagation
 - (a) Wind-With stronger headwinds, the aircraft can take off and climb more rapidly relative to the ground. Also, winds can influence the distribution of noise in surrounding communities.
 - (b) Temperature and Relative Humidity-The absorption of noise in the atmosphere along the transmission path between the aircraft and the ground observer varies with both temperature and relative humidity.

3. Surface Condition-Shielding, Extra Ground Attenuation (EGA)

- (a) Terrain-If the ground slopes down after takeoff or up before landing, noise will be reduced since the aircraft will be at a higher altitude above ground. Additionally, hills, shrubs, trees, and large buildings can act as sound buffers.

All these factors can alter the shape and size of the contours appreciably. To demonstrate the effect of some of these factors, estimated noise level contours for two different operating conditions are shown below. These contours reflect a given noise level upon a ground level plane at runway elevation.

Condition 1

Landing

Maximum Structural Landing
Weight
10-kn Headwind
3° Approach
84°F
Humidity 15%

Takeoff

Maximum Gross Takeoff
Weight
Zero Wind
84°F
Humidity 15%

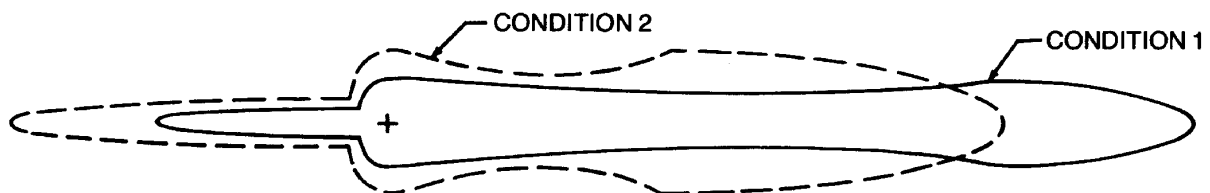

Condition 2

Landing

85% of Maximum Structural
Landing Weight
10-kn Headwind
3° Approach
59°F
Humidity 70%

Takeoff

80% of Maximum Gross
Takeoff Weight
10-kn Headwind
59°F
Humidity 70%

As indicated from these data, the contour size varies substantially with operating and atmospheric conditions. Most aircraft operations are, of course, conducted at less than maximum gross weights because average flight distances are much shorter than maximum aircraft range capability and average load factors are less than 100%. Therefore, in developing cumulative contours for planning purposes, it is recommended that the airlines serving a particular city be contacted to provide operational information.

In addition, there are no universally accepted methods for developing aircraft noise contours or for relating the acceptability of specific zones to specific land uses. It is therefore expected that noise contour data for particular aircraft and the impact assessment methodology will be changing. To ensure that the best currently available information of this type is used in any planning study, it is recommended that it be obtained directly from the Office of Environmental Quality in the Federal Aviation Administration in Washington, D.C.

It should be noted that the contours shown herein are only for illustrating the impact of operating and atmospheric conditions and do not represent the single-event contour of the family of aircraft described in this document. It is expected that the cumulative contours will be developed as required by planners using the data and methodology applicable to their specific study.

- 7.0 PAVEMENT DATA**
 - 7.1 General Information**
 - 7.2 Landing-Gear Footprint**
 - 7.3 Maximum Pavement Loads**
 - 7.4 Landing-Gear Loading on Pavement**
 - 7.5 Flexible-Pavement Requirements - U.S. Army
Corps of Engineers Method (S-77-1)**
 - 7.6 Flexible-Pavement Requirements - LCN Conversion**
 - 7.7 Rigid-Pavement Requirements - Portland Cement
Association Design Method**
 - 7.8 Rigid-Pavement Requirements - LCN Conversion**
 - 7.9 Rigid-Pavement Requirements - FAA Design**
 - 7.10 ACN/PCN Reporting System: Flexible and Rigid
Pavements**

7.0 PAVEMENT DATA

7.1 General Information

A brief description of the pavement charts that follow will help in their use for airport planning. Each airplane configuration is depicted with a minimum range of six loads imposed on the main landing gear to aid in interpolation between the discrete values shown. All curves for any single chart represent data based on rated loads and tire pressures considered normal and acceptable by current aircraft tire manufacturer's standards. Tire pressures, where specifically designated on tables and charts, are at values obtained under loaded conditions as certificated for commercial use.

Section 7.2 presents basic data on the landing gear footprint configuration, maximum design taxi loads, and tire sizes and pressures.

Maximum pavement loads for certain critical conditions at the tire-to-ground interface are shown in Section 7.3, with the tires having equal loads on the struts.

Pavement requirements for commercial airplanes are customarily derived from the static analysis of loads imposed on the main landing gear struts. The chart in Section 7.4 is provided in order to determine these loads throughout the stability limits of the airplane at rest on the pavement. These main landing gear loads are used as the point of entry to the pavement design charts, interpolating load values where necessary.

The flexible pavement design curves (Section 7.5) are based on procedures set forth in Instruction Report No. S-77-1, "Procedures for Development of CBR Design Curves," dated June 1977, and as modified according to the methods described in ICAO Aerodrome Design Manual, Part 3, Pavements, 2nd Edition, 1983, Section 1.1 (The ACN-PCN Method), and utilizing the alpha factors approved by ICAO in October 2007. Instruction Report No. S-77-1 was prepared by the U.S. Army Corps of Engineers Waterways Experiment Station, Soils and Pavements Laboratory, Vicksburg, Mississippi. The line showing 10,000 coverages is used to calculate Aircraft Classification Number (ACN).

The following procedure is used to develop the curves, such as shown in Section 7.5:

1. Having established the scale for pavement depth at the bottom and the scale for CBR at the top, an arbitrary line is drawn representing 6,000 annual departures.
2. Values of the aircraft gross weight are then plotted.
3. Additional annual departure lines are then drawn based on the load lines of the aircraft gross weights already established.
4. An additional line representing 10,000 coverages (used to calculate the flexible-pavement Aircraft Classification Number) is also placed.

All Load Classification Number (LCN) curves (Sections 7.6 and 7.8) have been developed from a computer program based on data provided in International Civil Aviation Organization (ICAO) document 7920-AN/865/2, Aerodrome Manual, Part 2, "Aerodrome Physical Characteristics," 2nd edition, 1965. LCN values are shown directly for parameters of weight on main landing gear, tire pressure, and radius of relative stiffness (k) for rigid pavement or pavement thickness or depth factor (h) for flexible pavement.

Rigid-pavement design curves (Section 7.7) have been prepared with the Westergaard equation in general accordance with the procedures outlined in the Design of Concrete Airport Pavement (1955 edition) by Robert G. Packard, published by the Portland Cement Association, 5420 Old Orchard Road, Skokie, Illinois 60076. These curves are modified to the format described in the Portland Cement Association publication XP6705-2, Computer Program for Airport Pavement Design (Program PDILB), 1968, by Robert G. Packard.

The following procedure is used to develop the rigid-pavement design curves such as shown in Section 7.7:

1. Having established the scale for pavement thickness to the left and the scale for allowable working stress to the right, an arbitrary load line is drawn representing the main landing gear maximum weight to be shown.
2. Values of the subgrade modulus (k) are then plotted.
3. Additional load lines for the incremental values of weight on the main landing gear are drawn on the basis of the curve for $k = 300$, already established.

The rigid-pavement design curves (Section 7.9) have been developed based on methods used in the FAA Advisory Circular AC 150/5320-6C, 7 December 1978. The following procedure is used to develop the curves, such as shown in Section 7.9:

1. Having established the scale for pavement flexural strength on the left and temporary scale for pavement thickness on the right, an arbitrary load line is drawn representing the main landing gear maximum weight to be shown at 5,000 coverages.
2. Values of the subgrade modulus (k) are then plotted.
3. Additional load lines for the incremental values of weight are then drawn on the basis of the subgrade modulus curves already established.
4. The permanent scale for the rigid-pavement thickness is then placed. Lines for other than 5,000 coverages are established based on the aircraft pass-to-coverage ratio.

Although not explicitly shown, the Portland Cement Association design-method curves are also applicable for the 747SP model. To use these curves for the 747SP, select a curve within the required main-gear load and tire pressure range. The pavement parameters then determined will approximate closely those for the 747SP.

The ACN/PCN system(Section 7.10) as referenced in Amendment 35 to ICAO Annex 14, "Aerodromes", 7th Edition, June 1976, provides a standardized international airplane/pavement rating system replacing the various S, T, TT, LCN, AUW, ISWL, etc., rating systems used throughout the world. ACN is the Aircraft Classification Number and PCN is the Pavement Classification Number. An aircraft having an ACN equal to or less than the PCN can operate on the pavement subject to any limitation on the tire pressure. Numerically, the ACN is two times the derived single-wheel load expressed in thousands of kilograms, where the derived single wheel load is defined as the load on a single tire inflated to 180 psi (1.25 MPa) that would have the same pavement requirements as the aircraft. Computationally, the ACN/PCN system uses the PCA program PDILB for rigid pavements and S-77-1 for flexible pavements to calculate ACN values. The method of pavement evaluation is left up to the airport with the results of their evaluation presented as follows:

PCN	Pavement Type	Subgrade Category	Tire-Pressure Category	Evaluation Method
	R - Rigid	A- High	W - No Limit	T - Technical
	F - Flexible	B - Medium	X - To 254 psi (1.75 MPa)	U - Using aircraft
		C - Low	Y - To 181 psi (1.25 MPa)	
		D - Ultra Low	Z - To 73 psi (0.5 MPa)	

Sections 7.10.1 and 7.10.2 show the aircraft ACN values for flexible pavements. The four subgrade categories are:

- Code A - High Strength - CBR 15
- Code B - Medium Strength - CBR 10
- Code C - Low Strength - CBR 6
- Code D - Ultra Low Strength - CBR 3

Sections 7.10.3 and 7.10.4 show the aircraft ACN values for rigid pavements. The four subgrade categories are:

- Code A - High Strength, $k = 550 \text{ pci}$ (150 MN/m^3)
- Code B - Medium Strength, $k = 300 \text{ pci}$ (80 MN/m^3)
- Code C - Low Strength, $k = 150 \text{ pci}$ (40 MN/m^3)
- Code D - Ultra Low Strength, $k = 75 \text{ pci}$ (20 MN/m^3)

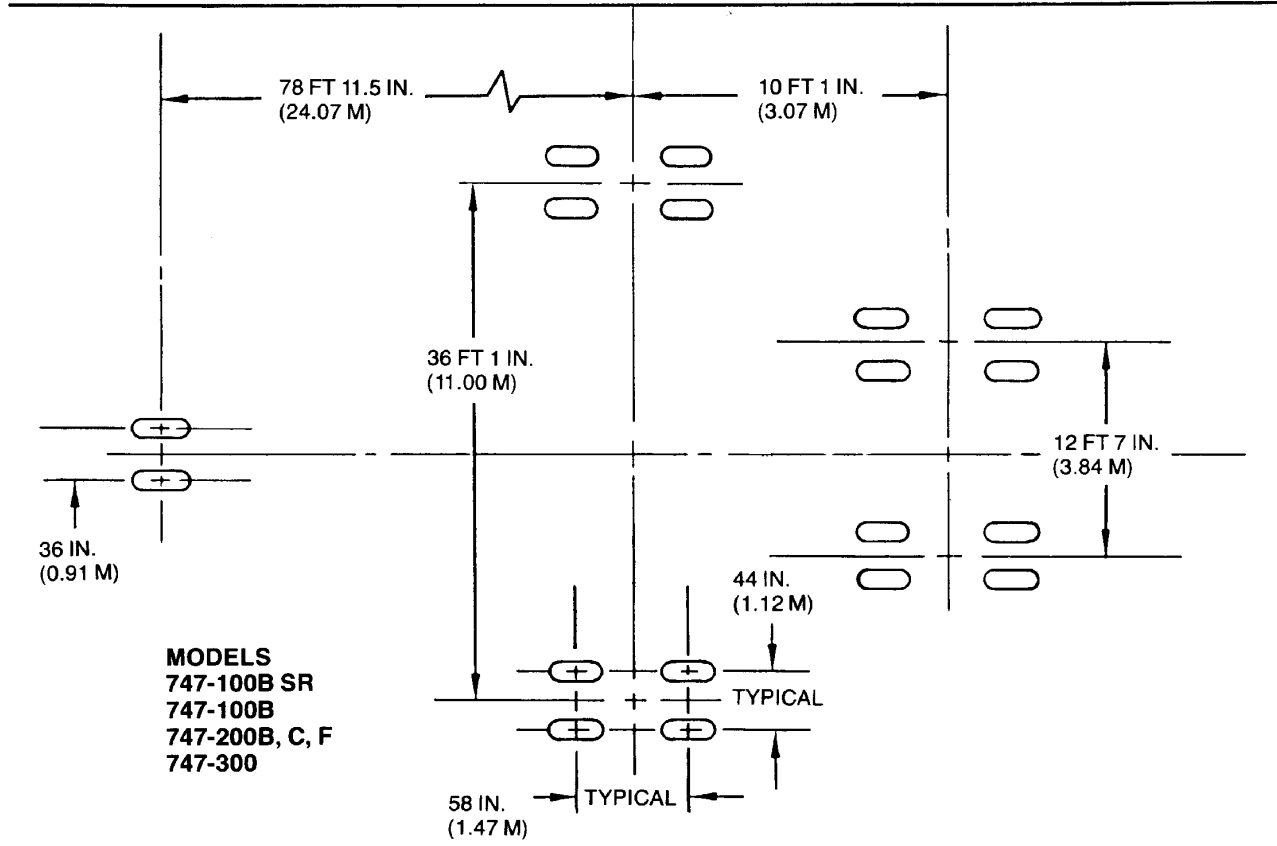
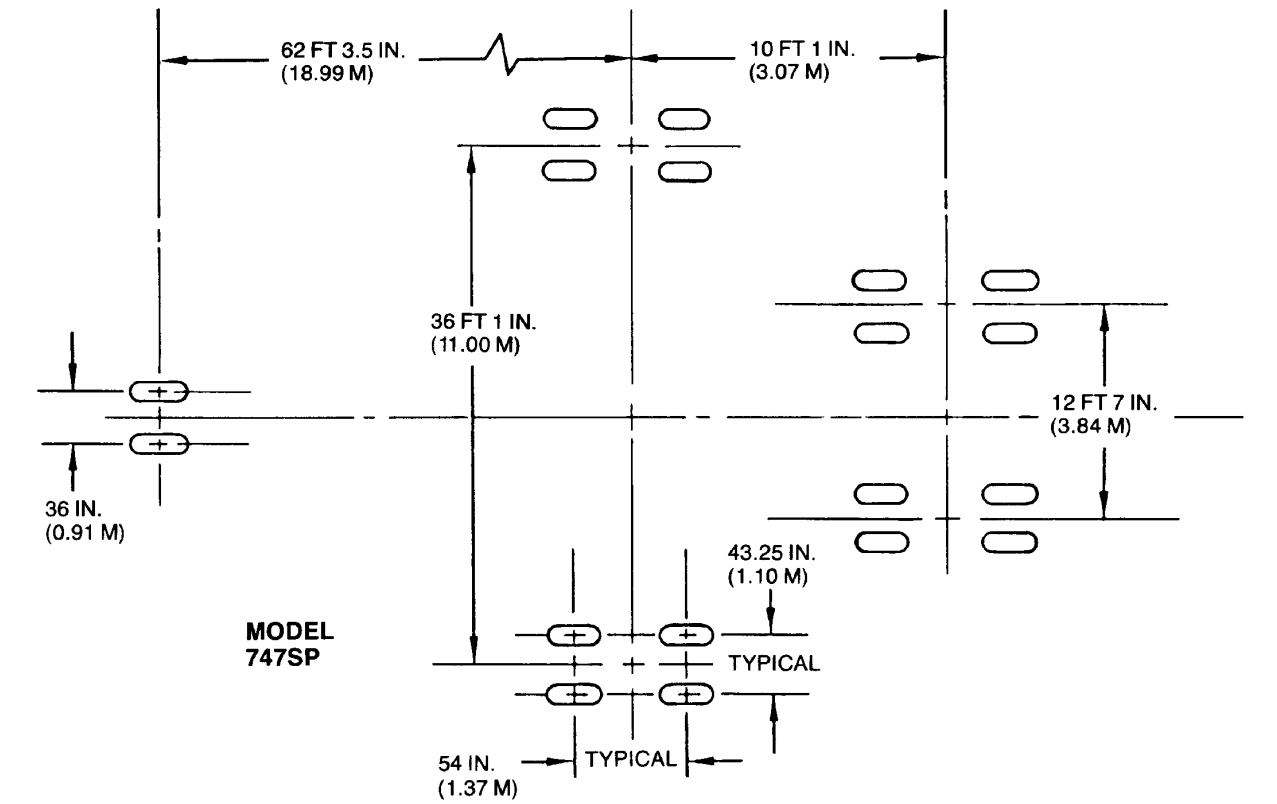

7.2.1 LANDING GEAR FOOTPRINT
MODEL 747

		AIRPLANE MODEL						
		-100B/300 SR		-100B/300			SP	
MAXIMUM DESIGN TAXI WEIGHT	LB KG	523,000 TO 573,000 237,200 TO 259,900	603,000 TO 613,000 273,500 TO 278,100	713,000 323,400	738,000 334,800	753,000 341,600	636,000 TO 676,000 288,500 TO 306,600	696,000 TO 703,000 315,700 TO 318,900
PERCENT OF WEIGHT ON MAIN GEAR		SEE SECTION 7.4					SEE SECTION 7.4	
NOSE GEAR TIRE SIZE	IN.	49x17 30PR	49x17 30PR	46x16 30PR	46x16 30PR	49x17 30PR	49x17 30PR	49x17 32PR
NOSE GEAR TIRE PRESSURE	PSI KG/ CM ²	127 8.9	140 9.8	195 13.7	202 14.2	170 12.0	202 14.2	209 14.7
MAIN GEAR TIRE SIZE	IN.	49x17 30PR	49x17 30PR	46x16 30PR	46x16 30PR	49x17 30PR	46x16 26PR	46x16 30PR
MAIN GEAR TIRE PRESSURE	PSI KG/ CM ²	151 10.6	161 11.3	217 15.3	226 15.9	191 13.4	188 13.2	203 14.3

NEW TIRES PER FAR 25, DECEMBER 31, 1979:

NOSE GEAR TIRE SIZE	IN.	49x17 28PR	49x17 28PR	46x16 30PR	46x16 32PR	49x17 32PR	49x17 30PR	49x17 32PR
NOSE GEAR TIRE PRESSURE	PSI KG/ CM ²	127 8.9	139 9.8	195 13.7	206 14.5	170 12.0	202 14.2	209 14.7
MAIN GEAR TIRE SIZE	IN.	49x17 28PR	49x17 28PR	46x16 30PR	46x16 32PR	49x17 32PR	46x16 28PR	46x16 30PR
MAIN GEAR TIRE PRESSURE	PSI KG/ CM ²	152 10.7	162 11.4	219 15.4	232 16.3	192 13.5	198 13.9	205 14.4

7.2.2 LANDING GEAR FOOTPRINT DATA
MODELS 747-100B, -300B, SP

		AIRPLANE MODEL				
		-200B, -200C, -200F, -300			-200C, -200F	
MAXIMUM DESIGN TAXI WEIGHT	LB	778,000	788,000 TO 808,000	823,000	836,000	836,000
	KG	352,900	357,400 TO 366,500	373,300	379,200	379,200
PERCENT OF WEIGHT ON MAIN GEAR		SEE SECTION 7.4				
NOSE GEAR TIRE SIZE	IN.	49x17 30PR	49x17 32PR	49x19-20 32PR	49x19-20 32PR	49x19-20 34PR
NOSE GEAR TIRE PRESSURE	PSI	197	202	183	183	188
	KG/CM ²	13.9	14.2	12.9	12.9	13.2
MAIN GEAR TIRE SIZE	IN.	49x17 30PR	49x17 32PR	49x19-20 32PR	49x19-20 32PR	49x19-20 34PR
MAIN GEAR TIRE PRESSURE	PSI	198	202	188	188	201
	KG/CM ²	13.9	14.2	13.2	13.2	14.1

NEW TIRES PER FAR 25, DECEMBER 31, 1979:

NOSE GEAR TIRE SIZE	IN.	49x17 32PR	49x17 32PR	49x19-20 32PR	49x19-20 32PR	49x19-20 34PR
NOSE GEAR TIRE PRESSURE	PSI	196	202	183	183	188
	KG/CM ²	13.8	14.2	12.9	12.9	13.2
MAIN GEAR TIRE SIZE	IN.	49x17 32PR	49x17 32PR	49x19-20 32PR	49x19-20 32PR	49x19-20 34PR
MAIN GEAR TIRE PRESSURE	PSI	199	204	189	190	201
	KG/CM ²	14.0	14.3	13.3	13.4	14.1

7.2.3 LANDING GEAR FOOTPRINT DATA
MODELS 747-200, -300

V_{NG} = MAXIMUM VERTICAL NOSE-GEAR GROUND LOAD AT MOST FORWARD CG
 V_{MG} = MAXIMUM VERTICAL MAIN-GEAR GROUND LOAD AT MOST AFT CG
 H = MAXIMUM HORIZONTAL GROUND LOAD FROM BRAKING

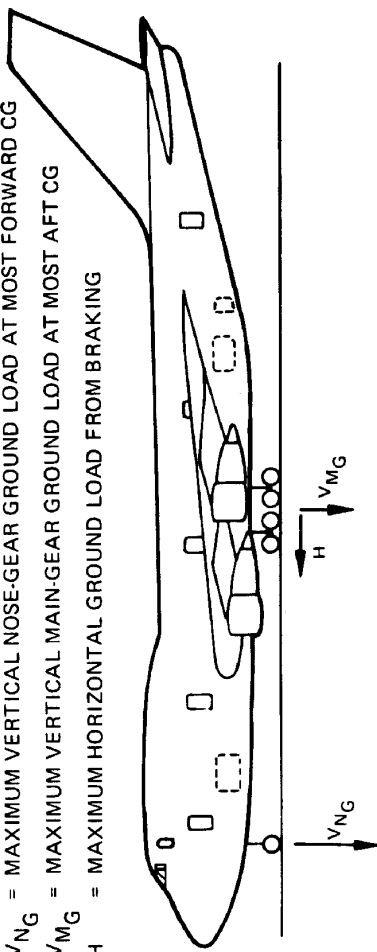

MODEL	MAXIMUM GROSS WEIGHT		V_{NG}				V_{MG} PER STRUT (4)				H PER STRUT (4)			
	LB	KG	STATIC AT MOST FORWARD CG		STATIC PLUS FORCE DUE TO BRAKING AT MOST FORWARD CG		MAXIMUM LOAD OCCURRING AT STATIC AFT CG		AT STEADY BRAKING AT 10 FT/SEC ² DECELERATION		AT INSTANTANEOUS BRAKING (COEFF OF FRICTION = 0.8)			
			LB	KG	LB	KG	LB	KG	LB	KG	LB	KG	LB	KG
-100B SR/300 SR	523,000	237,200	53,100	24,100	83,000	37,650	126,000	57,150	40,600	18,400	100,800	45,700	40,600	18,400
-100B SR/300 SR	573,000	259,900	58,600	26,600	91,200	41,350	138,000	62,600	44,500	20,200	110,400	50,100	44,500	20,200
-100B SR/300 SR	603,000	273,500	63,200	28,650	97,500	44,250	145,200	65,850	46,800	21,250	116,200	52,700	46,800	21,250
-100B SR/300 SR	613,000	278,100	64,300	29,150	99,100	44,950	147,700	67,000	47,600	21,600	118,200	53,600	47,600	21,600
-100B/300	713,000	323,400	74,700	33,900	116,600	52,900	166,500	75,500	55,400	25,150	133,200	60,400	55,400	25,150
-100B/300	738,000	334,800	77,400	35,100	120,700	54,750	170,600	77,400	57,300	26,000	136,500	61,900	57,300	26,000
-100B/300	753,000	341,600	78,900	35,800	122,300	55,450	174,000	78,900	58,500	26,550	139,200	63,150	58,500	26,550
SP	636,000	288,500	90,900	41,200	133,200	60,450	147,200	66,750	49,400	22,400	117,800	53,400	49,400	22,400
SP	666,000	302,000	95,200	43,200	139,700	63,350	152,200	69,000	51,700	23,450	121,700	55,200	51,700	23,450
SP	676,000	306,600	96,600	43,800	142,100	64,450	152,800	69,300	52,500	23,800	122,300	55,550	52,500	23,800
SP	696,000	315,700	96,700	43,850	144,300	65,450	153,600	69,650	54,000	24,500	122,900	55,750	54,000	24,500
SP	703,000	318,900	96,800	43,900	145,000	65,750	154,100	69,900	54,600	24,750	123,300	55,950	54,600	24,750

7.3.1 MAXIMUM PAVEMENT LOADS
 MODELS 747-100B, -300, SP

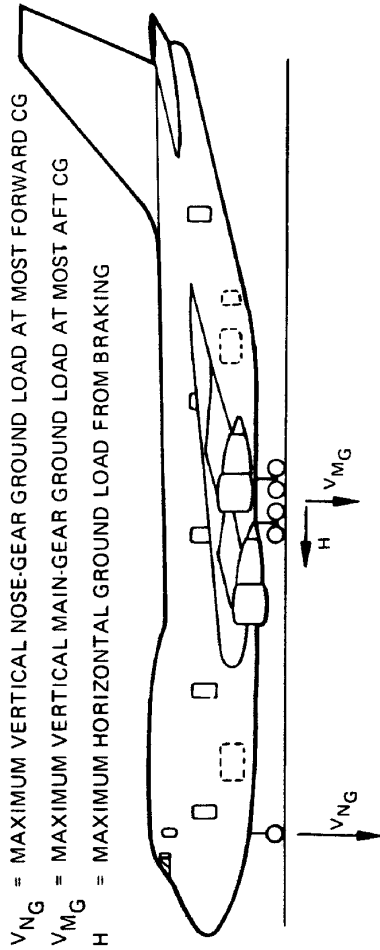

V_{NG} = MAXIMUM VERTICAL NOSE-GEAR GROUND LOAD AT MOST FORWARD CG

V_{MG} = MAXIMUM VERTICAL MAIN-GEAR GROUND LOAD AT MOST AFT CG

H = MAXIMUM HORIZONTAL GROUND LOAD FROM BRAKING

MODEL	MAXIMUM GROSS WEIGHT		V_{NG}				V_{MG} PER STRUT (4)				H PER STRUT (4)			
			STATIC AT MOST FORWARD CG		STATIC PLUS FORCE DUE TO BRAKING AT MOST FORWARD CG		MAXIMUM LOAD OCCURRING AT STATIC AFT CG		AT STEADY BRAKING 10 FT/SEC ² DECELERATION		AT INSTANTANEOUS BRAKING (COEFF OF FRICTION = 0.8)			
	LB	KG	LB	KG	LB	KG	LB	KG	LB	KG	LB	KG	LB	KG
-200B/300, 200C, -200B/300 COMBI	778,000	352,900	90,400	41,000	135,700	61,550	183,800	83,350	60,400	27,400	147,000	66,700	147,000	66,700
-200F	778,000	352,900	84,100	38,150	129,400	58,700	183,800	83,350	60,400	27,400	147,000	66,700	147,000	66,700
-200B/300, -200B/300 COMBI	788,000	357,400	91,600	41,550	137,700	62,450	185,200	84,000	61,200	27,750	148,200	67,200	148,200	67,200
-200C	788,000	357,400	90,800	41,200	136,900	62,100	185,200	84,000	61,200	27,750	148,200	67,200	148,200	67,200
-200F	788,000	357,400	84,700	38,400	130,700	59,300	185,200	84,000	61,200	27,750	148,200	67,200	148,200	67,200
-200B/300, -200B/300 COMBI	808,000	366,500	93,400	42,350	141,100	63,950	187,900	85,250	62,700	28,450	150,300	68,200	150,300	68,200
-200C	808,000	366,500	91,800	41,650	139,500	63,300	187,900	82,250	62,700	28,450	150,300	68,200	150,300	68,200
-200F	808,000	366,500	85,500	38,800	133,200	60,400	187,900	85,250	62,700	28,450	150,300	68,200	150,300	68,200
-200B/300, -200B/300 COMBI	823,000	373,300	93,000	42,200	141,300	64,100	189,900	86,150	63,900	29,000	151,900	69,000	151,900	69,000
-200C	823,000	373,300	92,400	41,900	140,700	63,800	189,900	86,150	63,900	29,000	151,900	69,000	151,900	69,000
-200F	823,000	373,300	86,300	39,150	134,600	61,050	189,900	86,150	63,900	29,000	151,900	69,000	151,900	69,000
-200B, -300	836,000	379,200	92,800	42,100	137,800	62,500	190,100	86,250	64,900	29,450	152,100	69,000	152,100	69,000
-200C	836,000	379,200	92,800	42,100	141,700	64,250	190,100	86,250	64,900	29,450	152,100	69,000	152,100	69,000
-200C	836,000	379,200	92,800	42,100	141,700	64,250	193,900	87,950	64,900	29,450	155,100	70,350	155,100	70,350
-200B COMBI, -300 COMBI	836,000	379,200	92,800	42,100	139,900	63,450	190,100	86,250	64,900	29,450	152,100	69,000	152,100	69,000
-200B COMBI, -300 COMBI	836,000	379,200	92,800	42,100	139,900	63,450	193,900	87,950	64,900	29,450	155,100	70,350	155,100	70,350
-200F	836,000	379,200	86,800	39,350	135,600	61,500	190,100	86,250	64,900	29,450	152,100	69,000	152,100	69,000
-200F	836,000	379,200	86,800	39,350	135,600	61,500	193,900	87,950	64,900	29,450	155,100	70,350	155,100	70,350

7.3.2 MAXIMUM PAVEMENT LOADS MODELS 747-200, -300

NOTE: UNSHADED AREAS REPRESENT OPERATIONAL LIMITS.

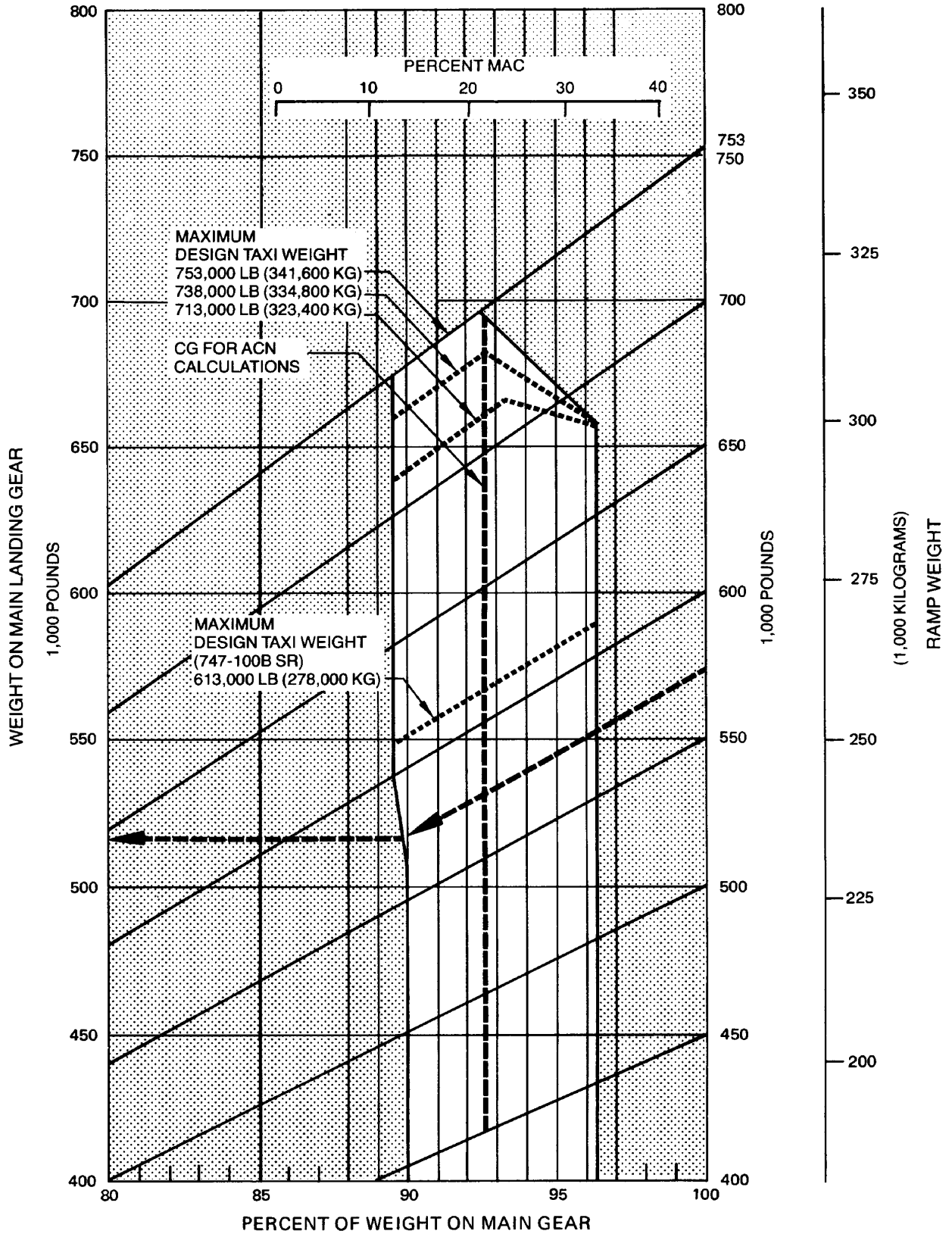

7.4.1 LANDING GEAR LOADING ON PAVEMENT
MODELS 747-100B, -300

NOTE: UNSHADED AREAS REPRESENT OPERATIONAL LIMITS.

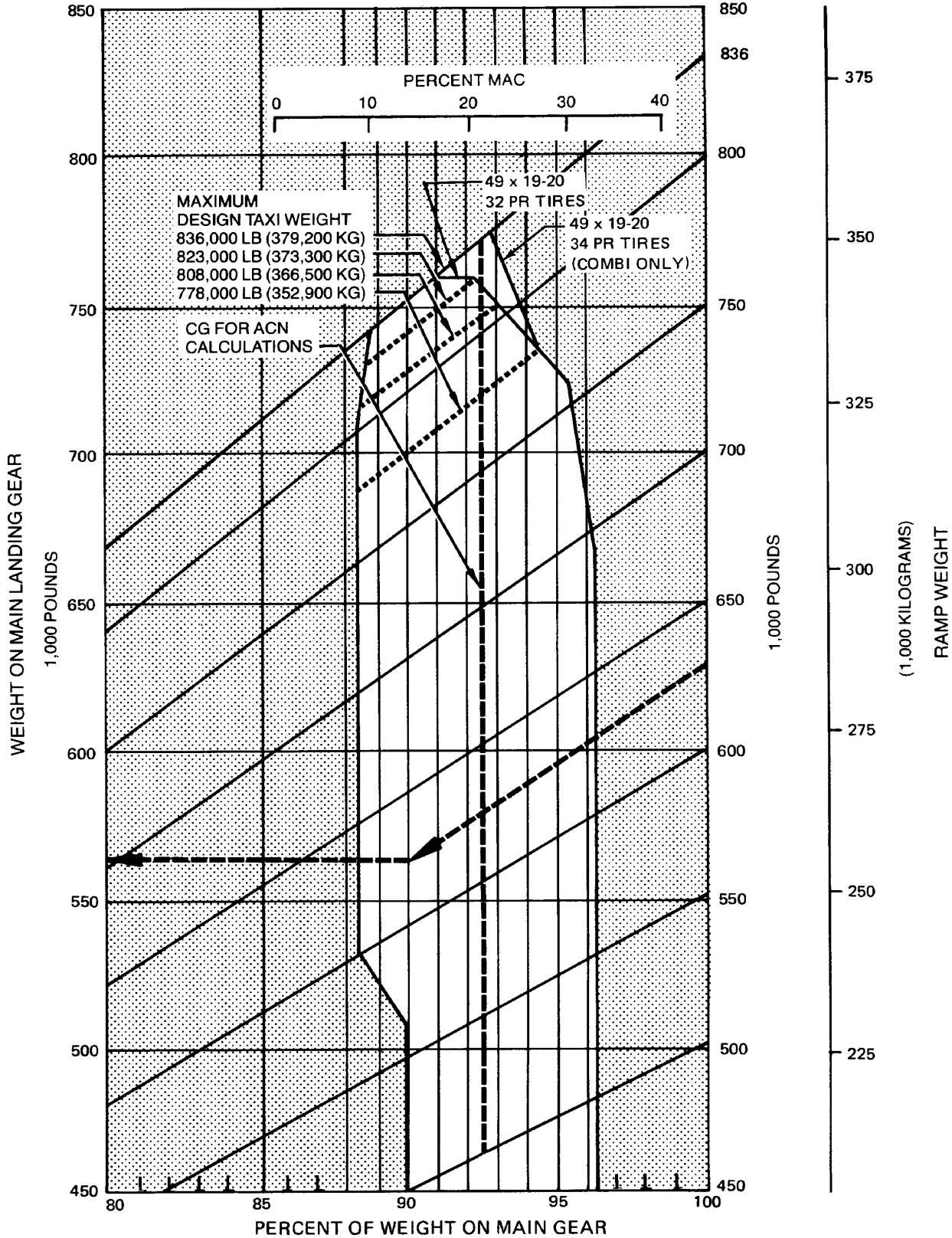

7.4.2 LANDING GEAR LOADING ON PAVEMENT
MODELS 747-200B, -300, COMBI

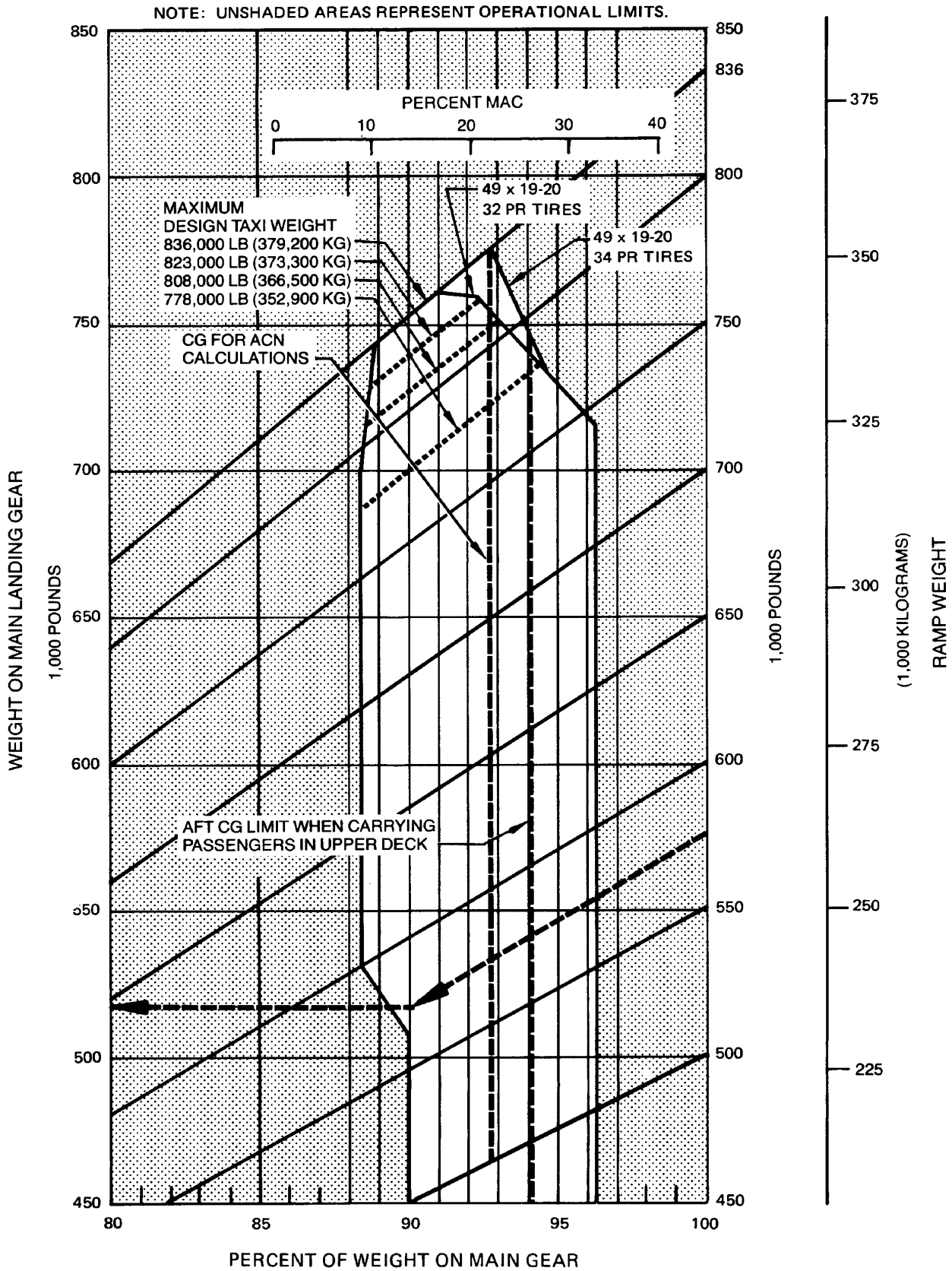

7.4.3 LANDING GEAR LOADING ON PAVEMENT
MODEL 747-200C

D6-58326

MAY 1984

195

NOTE: UNSHADED AREAS REPRESENT OPERATIONAL LIMITS.

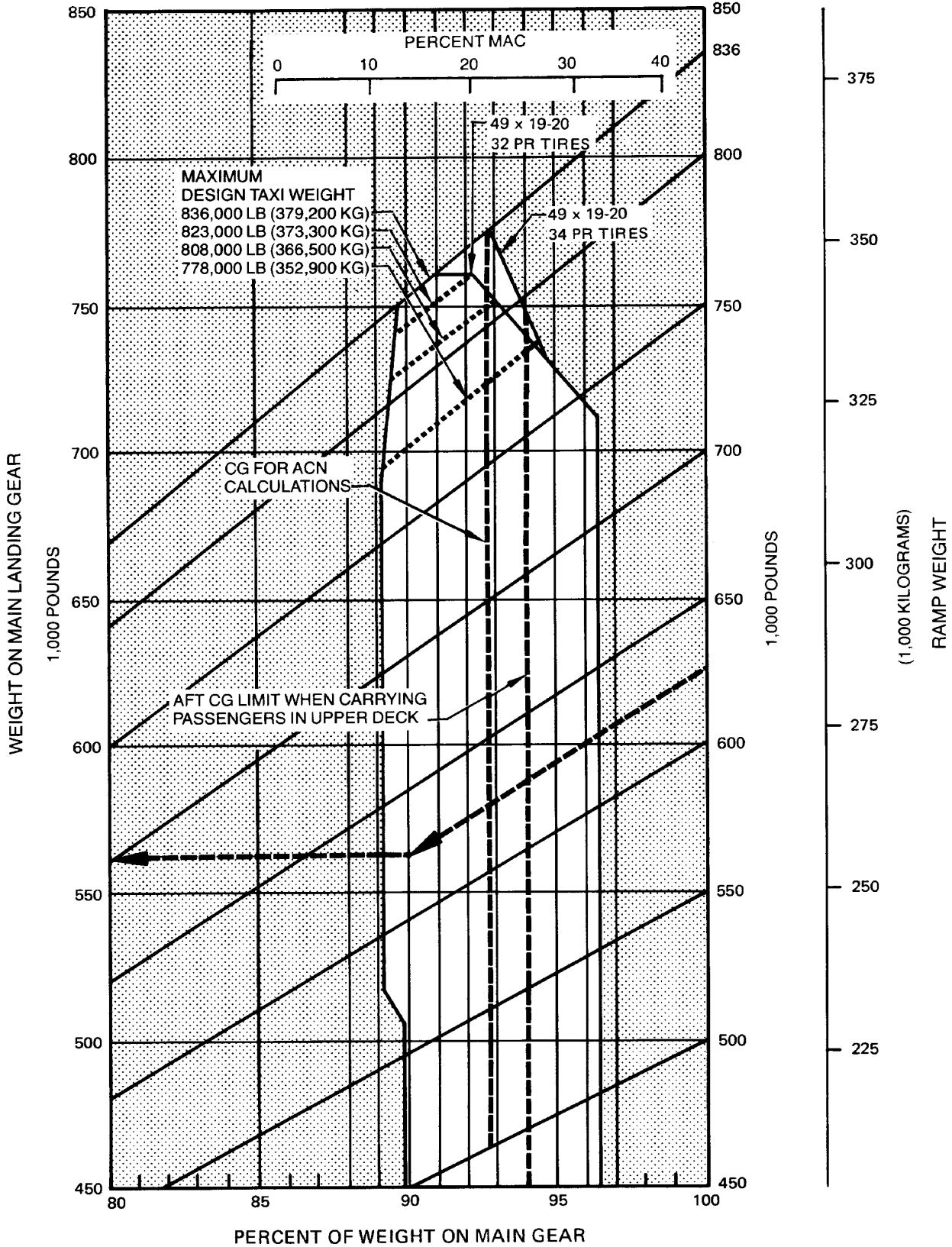

7.4.4 LANDING GEAR LOADING ON PAVEMENT
MODEL 747-200F

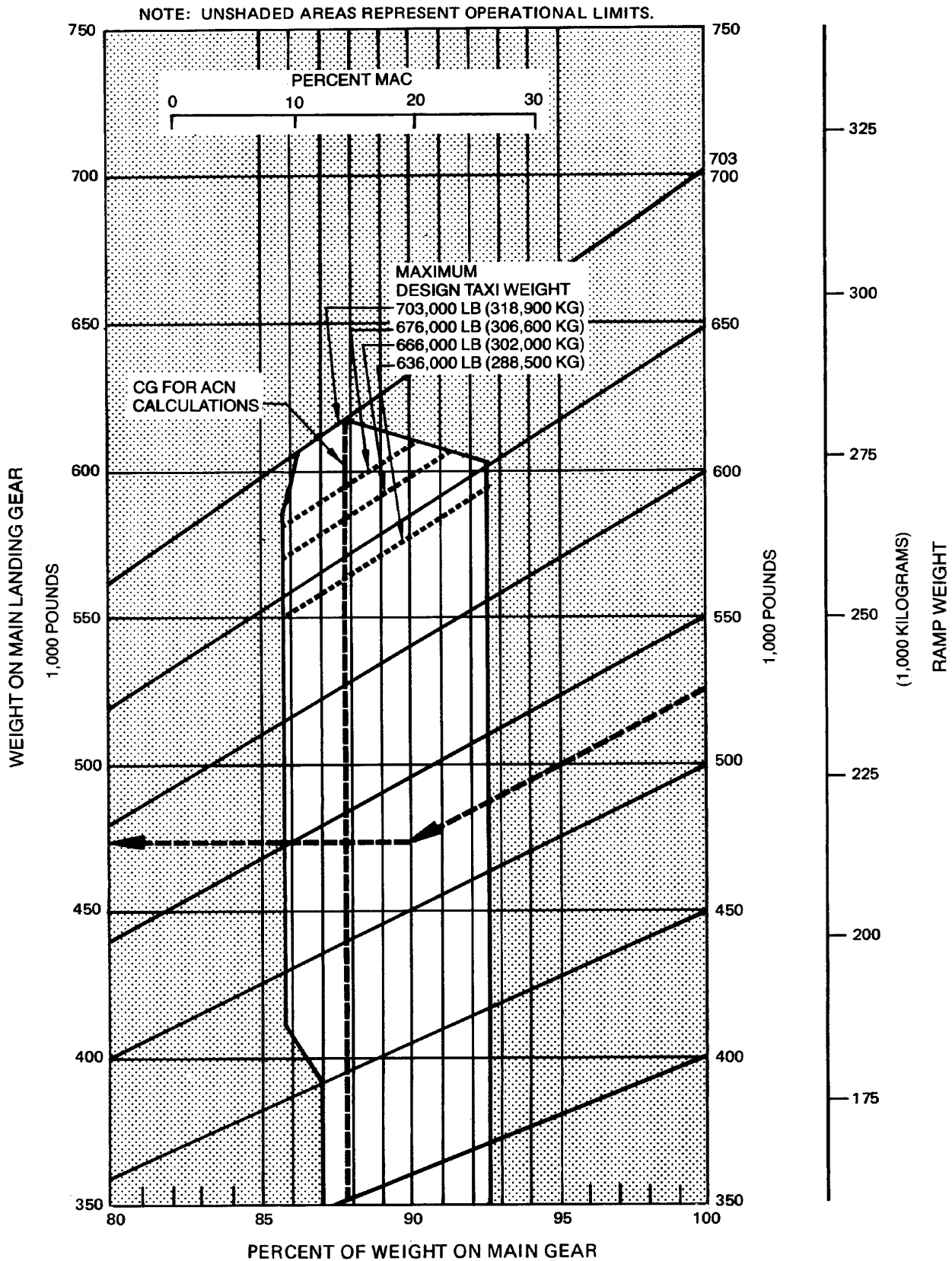

7.4.5 LANDING GEAR LOADING ON PAVEMENT
MODEL 747SP

D6-58326

MAY 1984

197

7.5 Flexible-Pavement Requirements - U.S. Army Corps of Engineers Method S-77-1

The 747 flexible-pavement design charts that follow present data of six incremental main-gear loadings (four on the 747SP) at the minimum tire pressure required at the maximum design taxi weight of the model under consideration.

In the example shown on the next page, for a CBR of 30 and an annual departure level of 6,000, the required flexible-pavement thickness for an airplane with a main-gear loading of 700,000 lb is 12 in.

The line showing 10,000 coverages is used for ACN calculations (see Section 7.10).

The FAA design method uses a similar procedure using total airplane weight instead of weight on main landing gears. The equivalent main gear loads for a given airplane weight could be calculated from Section 7.4.

CALIFORNIA BEARING RATIO (CBR)

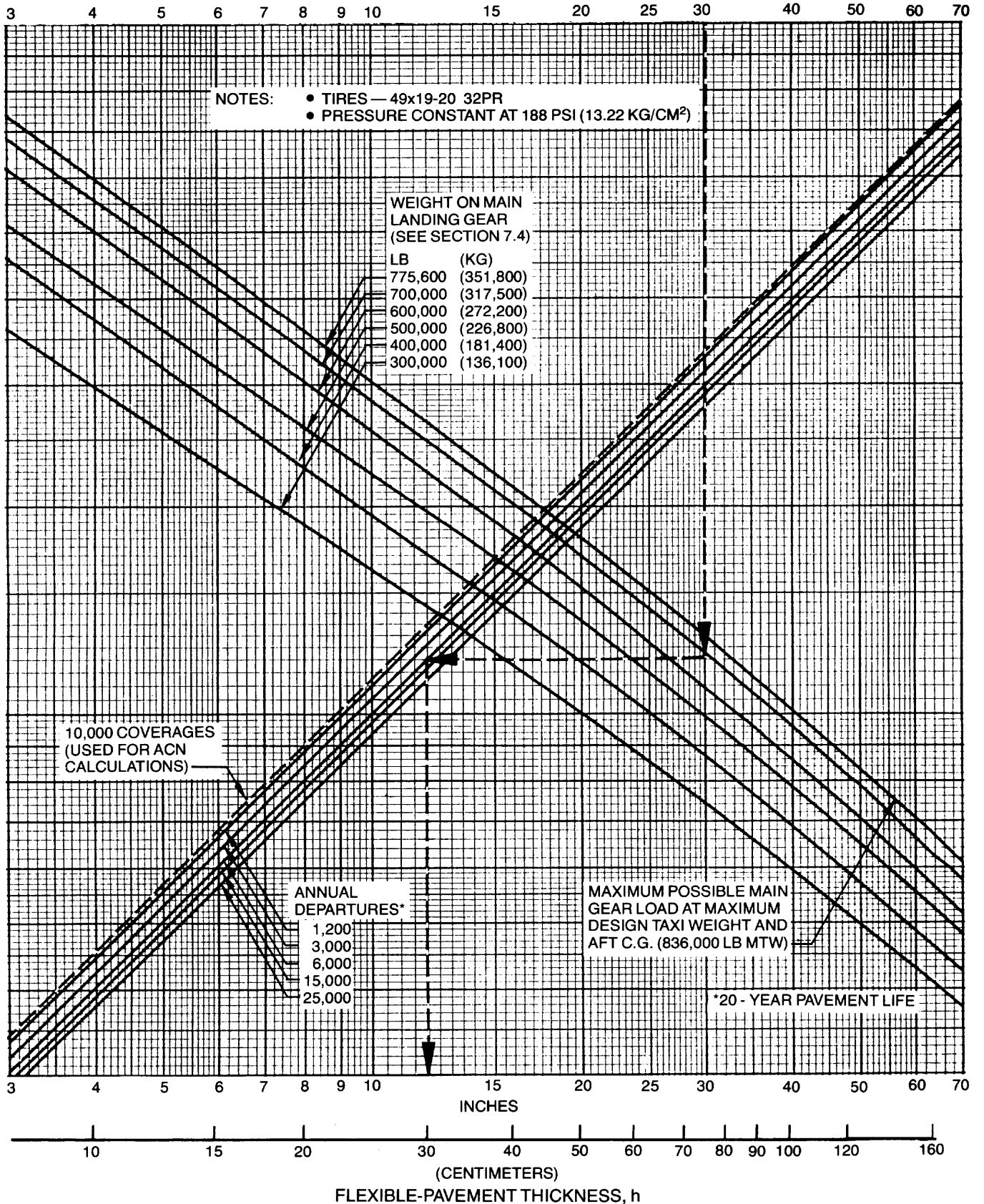

7.5.1 FLEXIBLE-PAVEMENT REQUIREMENTS-U.S. ARMY CORPS OF ENGINEERS DESIGN METHOD S-77-1 AND FAA DESIGN METHOD MODELS 747-100B, -200, -300

D6-58326

MAY 1984

199

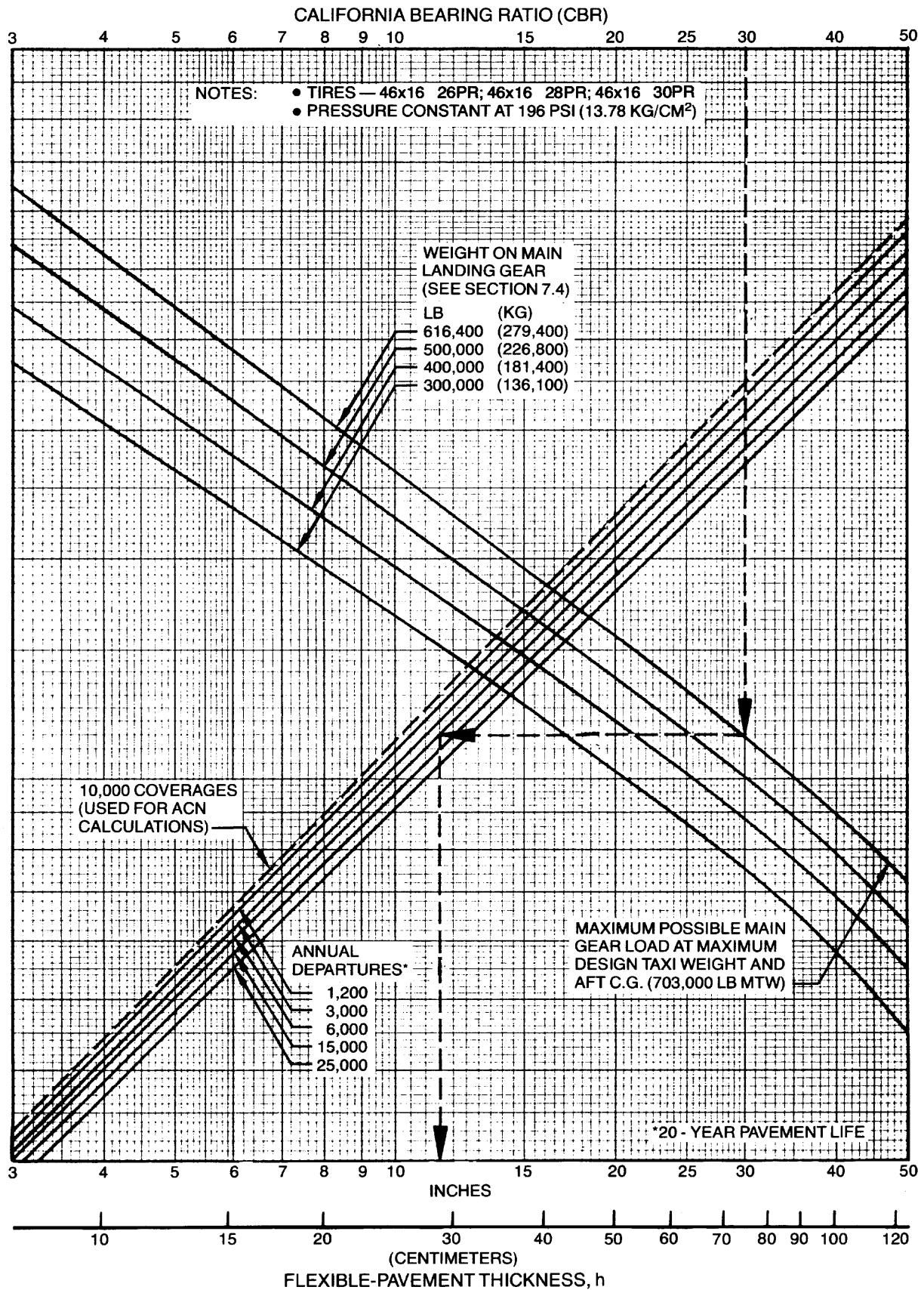

7.5.2 FLEXIBLE-PAVEMENT REQUIREMENTS-U.S. ARMY CORPS OF ENGINEERS DESIGN METHOD S-77-1 AND FAA DESIGN METHOD MODEL 747SP

7.6 Flexible-Pavement Requirements—LCN Conversion

To determine the airplane weight that can be accommodated on a particular flexible pavement, both the LCN and the thickness (h) of the pavement must be known.

In the example shown on the next page, flexible-pavement thickness (h) is shown at 30 in. with an LCN of 52. For these conditions, the apparent maximum allowable weight permissible on the main landing gear is 400,000 lb.

Note: Provided that the resultant airplane LCN is not more than 10% above the published pavement LCN, the bearing strength of the pavement can be sufficient for unlimited use by the aircraft. The figure of 10% has been chosen as representing the lowest degree of variation in LCN that is significant (reference: ICAO Aerodrome Manual, Part 2, "Aerodrome Physical Characteristics," Chapter 4, Paragraph 4.1.5.7v, 2nd Edition, dated 1965).

- NOTES:
- TIRES — 49x17 28PR; 49x17 30PR
 - PRESSURE RANGE FROM 151 TO 162 PSI (10.6 TO 11.4 KG/CM²)
 - EQUIVALENT SINGLE-WHEEL LOADS ARE DERIVED BY METHODS SHOWN IN ICAO AERODROME MANUAL, PART 2, PAR. 4.1.3. DATED 1965

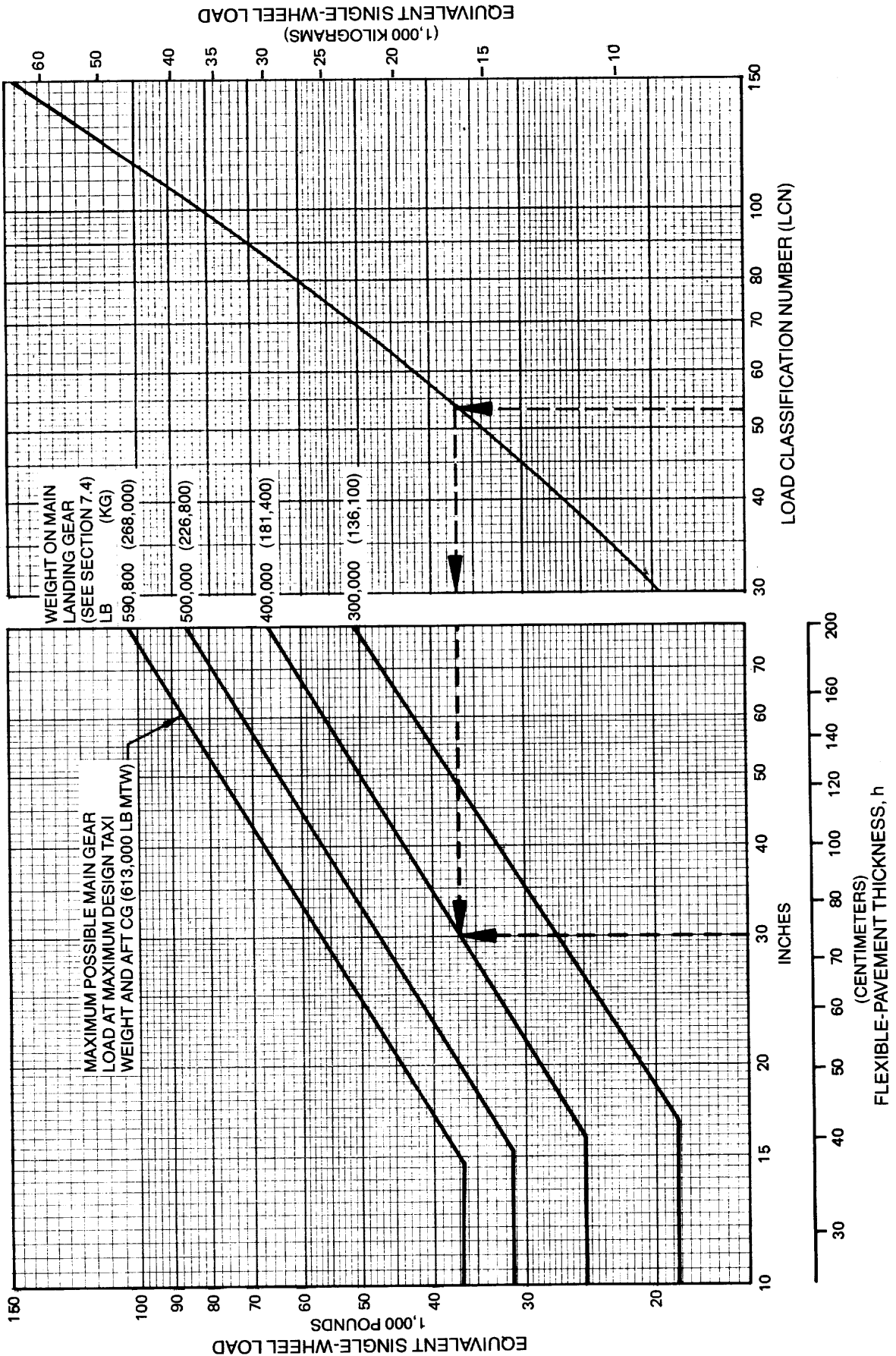

7.6.1 FLEXIBLE-PAVEMENT REQUIREMENTS — LCN CONVERSION
 MODELS 747-100B SR, -300 SR UP TO 613,000 LB (278,100 KG) MTW

- NOTES:
- TIRES — 46x16 30PR
 - PRESSURE RANGE FROM 217 TO 219 PSI (15.3 TO 15.4 KG/CM²)
 - EQUIVALENT SINGLE-WHEEL LOADS ARE DERIVED BY METHODS SHOWN IN ICAO AERODROME MANUAL, PART 2, PAR. 4.1.3, DATED 1965

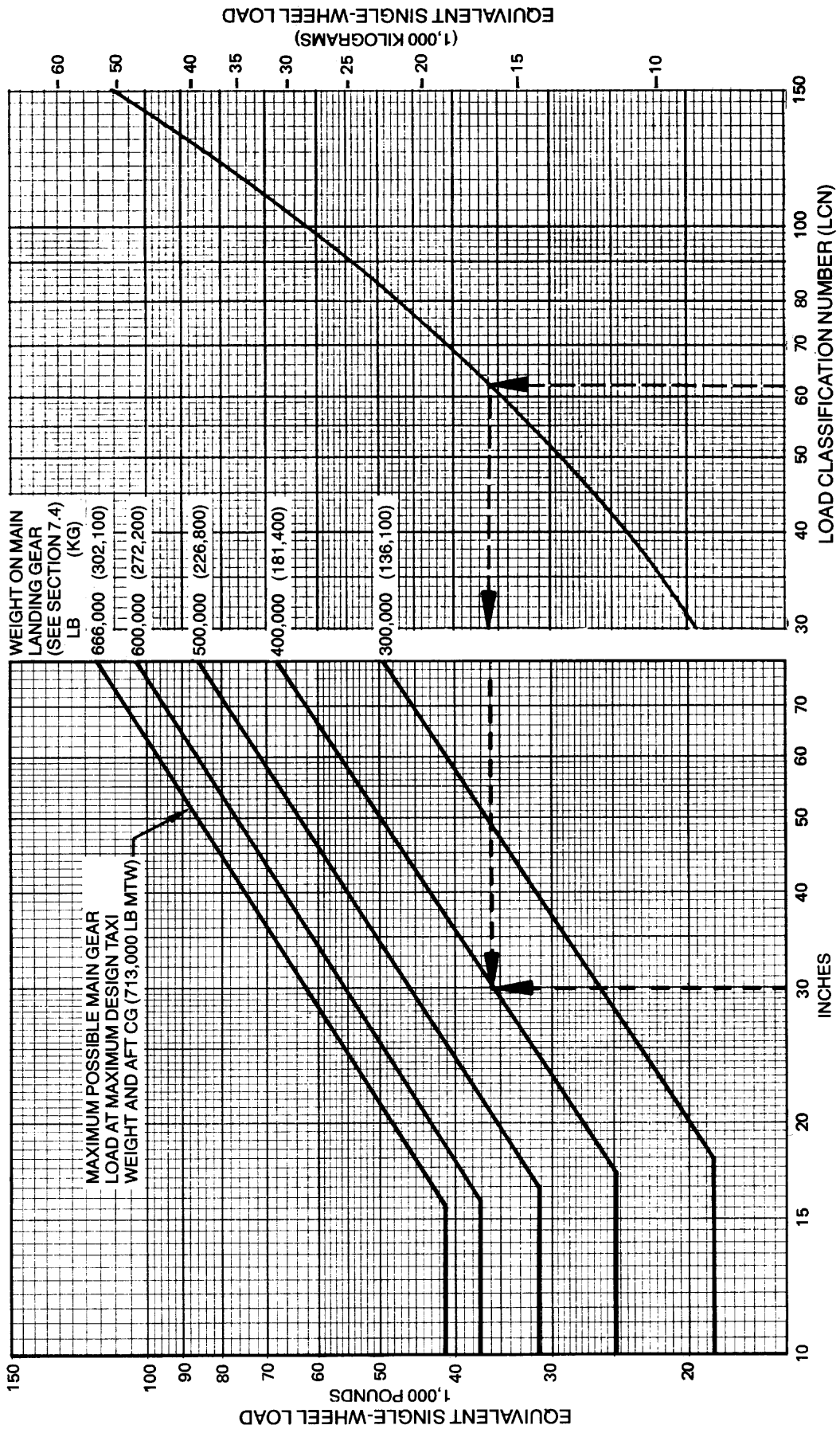

7.6.2 FLEXIBLE-PAVEMENT REQUIREMENTS — LCN CONVERSION
 MODELS 747-100B, -300 AT 713,100 LB (323,400 KG) MTW

- NOTES:
- TIRES — 46x16 30PR; 46x16 32PR
 - PRESSURE RANGE FROM 226 TO 232 PSI (15.9 TO 16.3 KG/CM²)
 - EQUIVALENT SINGLE-WHEEL LOADS ARE DERIVED BY METHODS SHOWN IN ICAO AERODROME MANUAL, PART 2, PAR. 4.1.3, DATED 1965

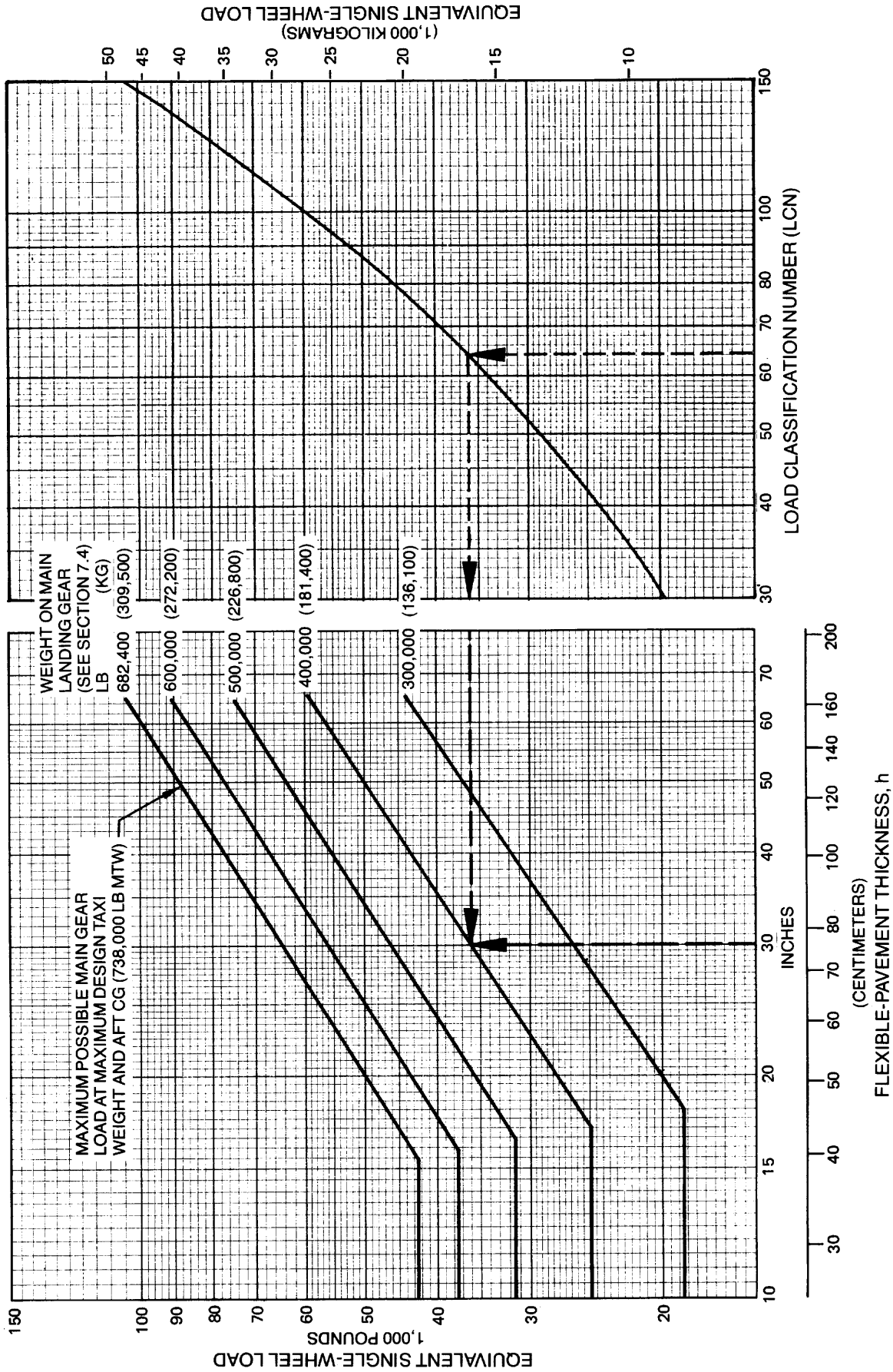

7.6.3 FLEXIBLE-PAVEMENT REQUIREMENTS — LCN CONVERSION
MODELS 747-100B, -300 AT 738,000 LB (334,800 KG) MTW

- NOTES:
- TIRES — 49x19-20 34PR; 49x17 30PR; 49x17 32PR; 49x19-20 32PR
 - PRESSURE RANGE FROM 188 TO 201 PSI (13.2 TO 14.1 KG/CM²)
 - EQUIVALENT SINGLE-WHEEL LOADS ARE DERIVED BY METHODS SHOWN IN ICAO AERODROME MANUAL, PART 2, PAR. 4.1.3. DATED 1965

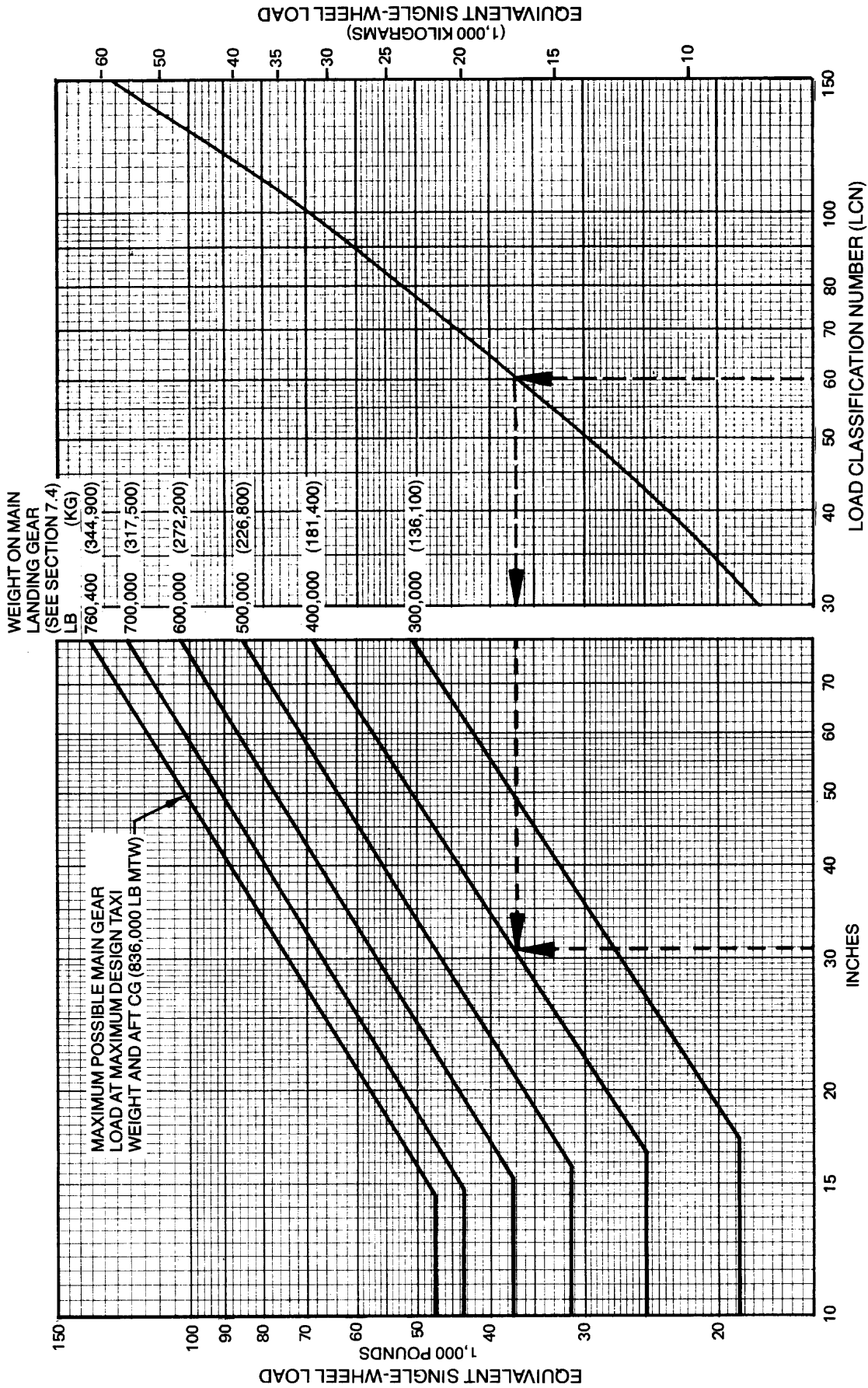

7.6.4 FLEXIBLE-PAVEMENT REQUIREMENTS — LCN CONVERSION

MODELS 747-100B, -300 AT 753,000 LB (341,600 KG) MTW AND
747-200, -300 AT 823,000 LB (373,300 KG) TO 836,000 LB (379,200 KG) MTW

D6-58326

MAY 1984

205

- NOTES:
- TIRES — 49x17 32PR; 49x19-20 34PR
 - PRESSURE RANGE FROM 198 TO 204 PSI (13.9 TO 14.3 KG/CM²)
 - EQUIVALENT SINGLE-WHEEL LOADS ARE DERIVED BY METHODS SHOWN IN ICAO AERODROME MANUAL, PART 2, PAR. 4.1.3, DATED 1965

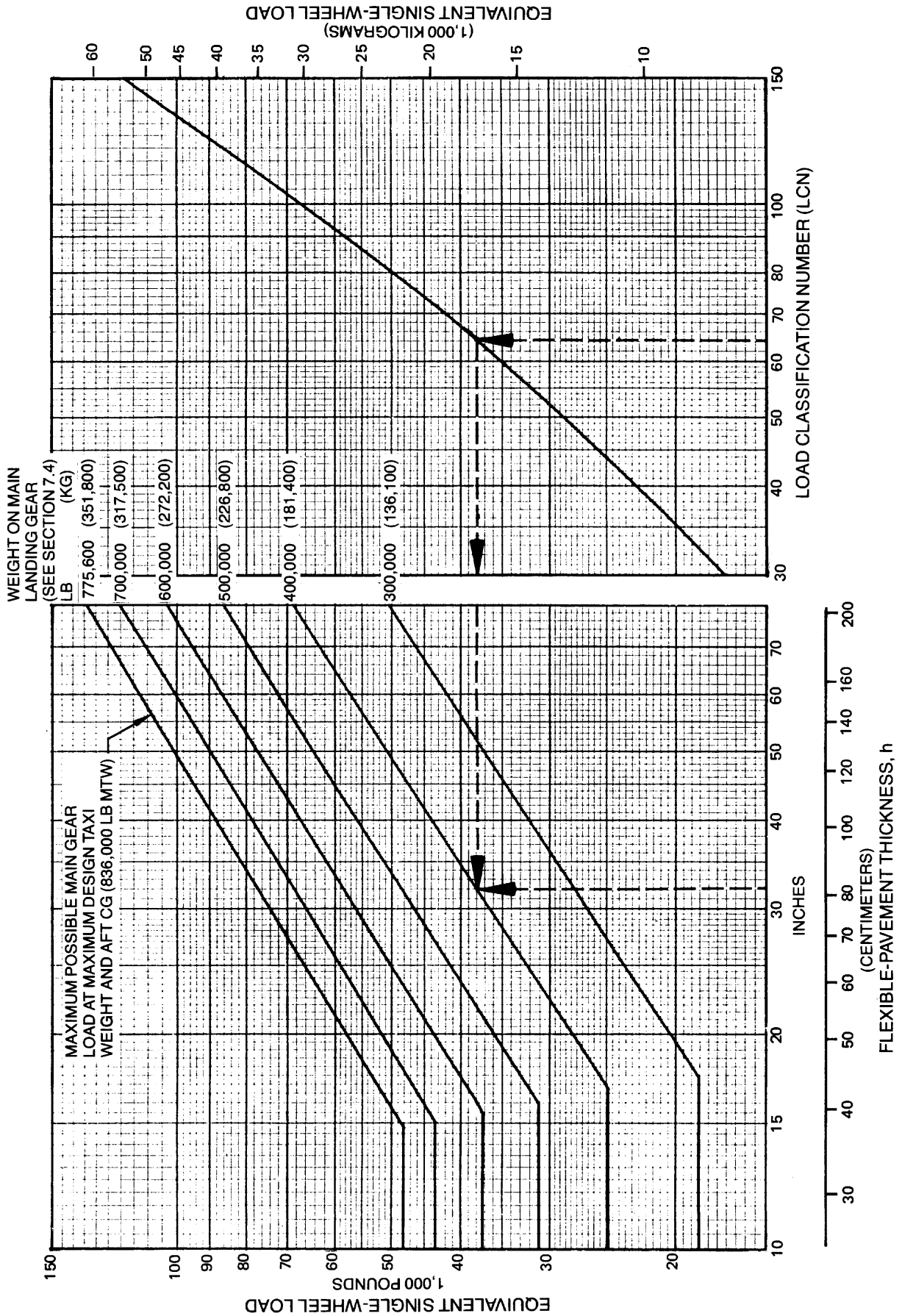

7.6.5 FLEXIBLE-PAVEMENT REQUIREMENTS — LCN CONVERSION

MODELS 747-200, -300 AT 778,000 LB TO 808,000 LB (366,500 KG) AND 836,000 LB (379,200 KG) MTW

- NOTES:
- TIRES — 46x16 26PR; 46x16 28PR; 46x16 30PR
 - PRESSURE RANGE FROM 188 TO 203 PSI (13.22 TO 14.27 KG/CM²)
 - EQUIVALENT SINGLE-WHEEL LOADS ARE DERIVED BY METHODS SHOWN IN ICAO AERODROME MANUAL, PART 2, PAR. 4.1.3. DATED 1965

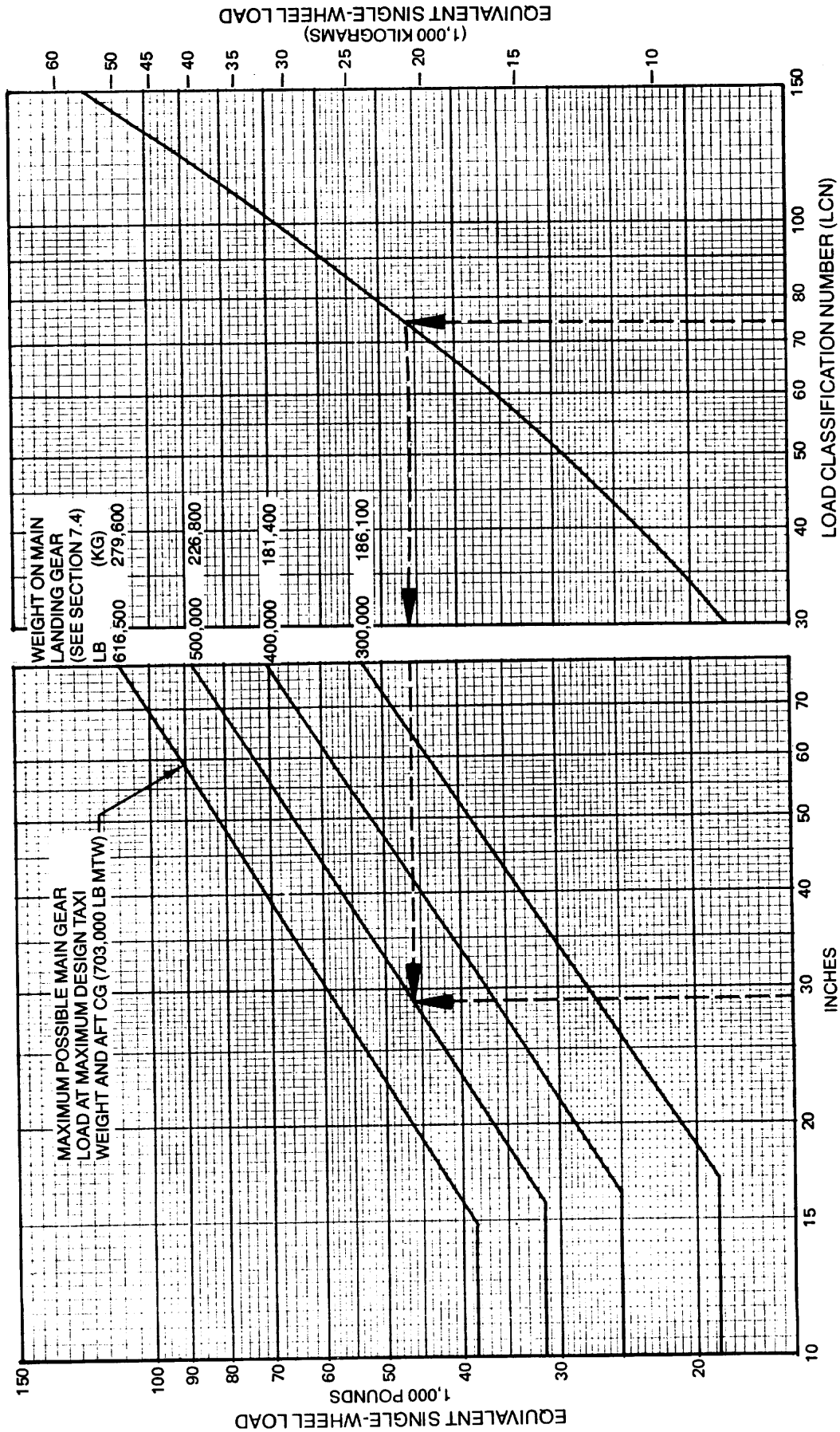

7.6.6 FLEXIBLE-PAVEMENT REQUIREMENTS — LCN CONVERSION
MODELS 747SP UP TO 703,000 LB (318,800 KG) MTW

7.7 Rigid-Pavement Requirements—Portland Cement Association Design Method

Rigid-pavement requirements are based on the Portland Cement Association computerized version of concrete airport pavement design as referenced on each chart.

The 747 rigid-pavement charts that follow are prepared for tires and pressures as indicated. Each chart presents data for a minimum of four incremental main-gear weights at the constant tire pressure required at the maximum gross weight of the 747 model under consideration.

In the example shown on the next page for an allowable working stress of 520 psi, a main gear load of 500,000 lb, and a subgrade strength k of 300, the required rigid-pavement thickness is 7.8 in.

- NOTES:
- TIRES — 49x17 28PR; 49x17 30PR
 - PRESSURE RANGE FROM 151 TO 162 PSI (10.6 TO 11.4 KG/CM²)

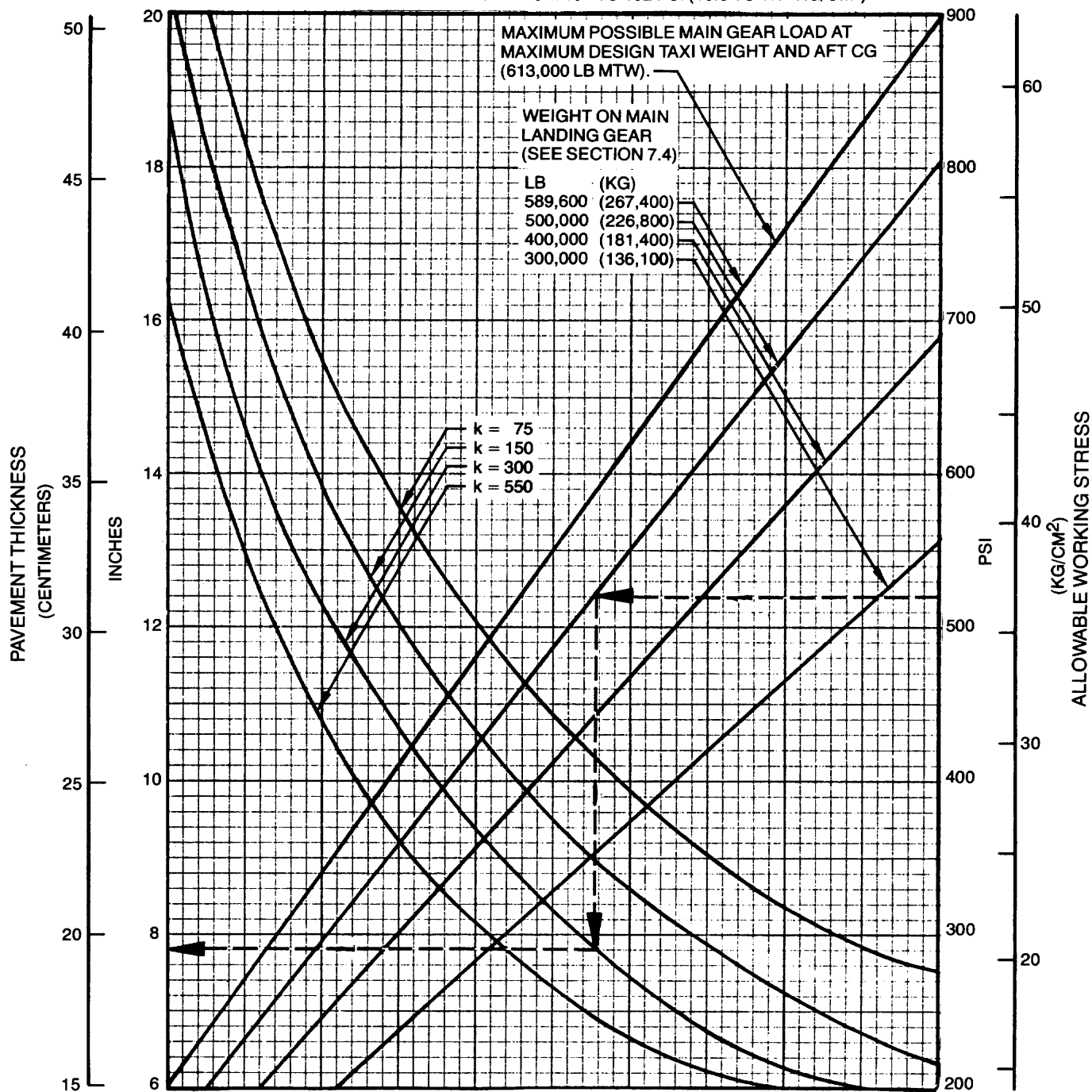

NOTE:
THE VALUES OBTAINED BY USING THE MAXIMUM
LOAD REFERENCE LINE AND ANY VALUE OF k
ARE EXACT. FOR LOADS LESS THAN MAXIMUM,
THE CURVES ARE EXACT FOR k=300 BUT
DEVIATE SLIGHTLY FOR OTHER VALUES OF k.

REFERENCES:
"DESIGN OF CONCRETE AIRPORT PAVEMENT"
AND "COMPUTER PROGRAM FOR AIRPORT
PAVEMENT DESIGN-PROGRAM PDILB,"
PORTLAND CEMENT ASSOCIATION.

7.7.1 RIGID-PAVEMENT REQUIREMENTS - PORTLAND CEMENT ASSOCIATION DESIGN METHOD MODELS 747-100B SR, -300 SR UP TO 613,000 LB (278,100 KG) MTW

- NOTES: • TIRES — 46x16 30PR; 46x16 32PR
 • PRESSURE RANGE FROM 217 TO 232 PSI (15.3 TO 16.3 KG/CM²)

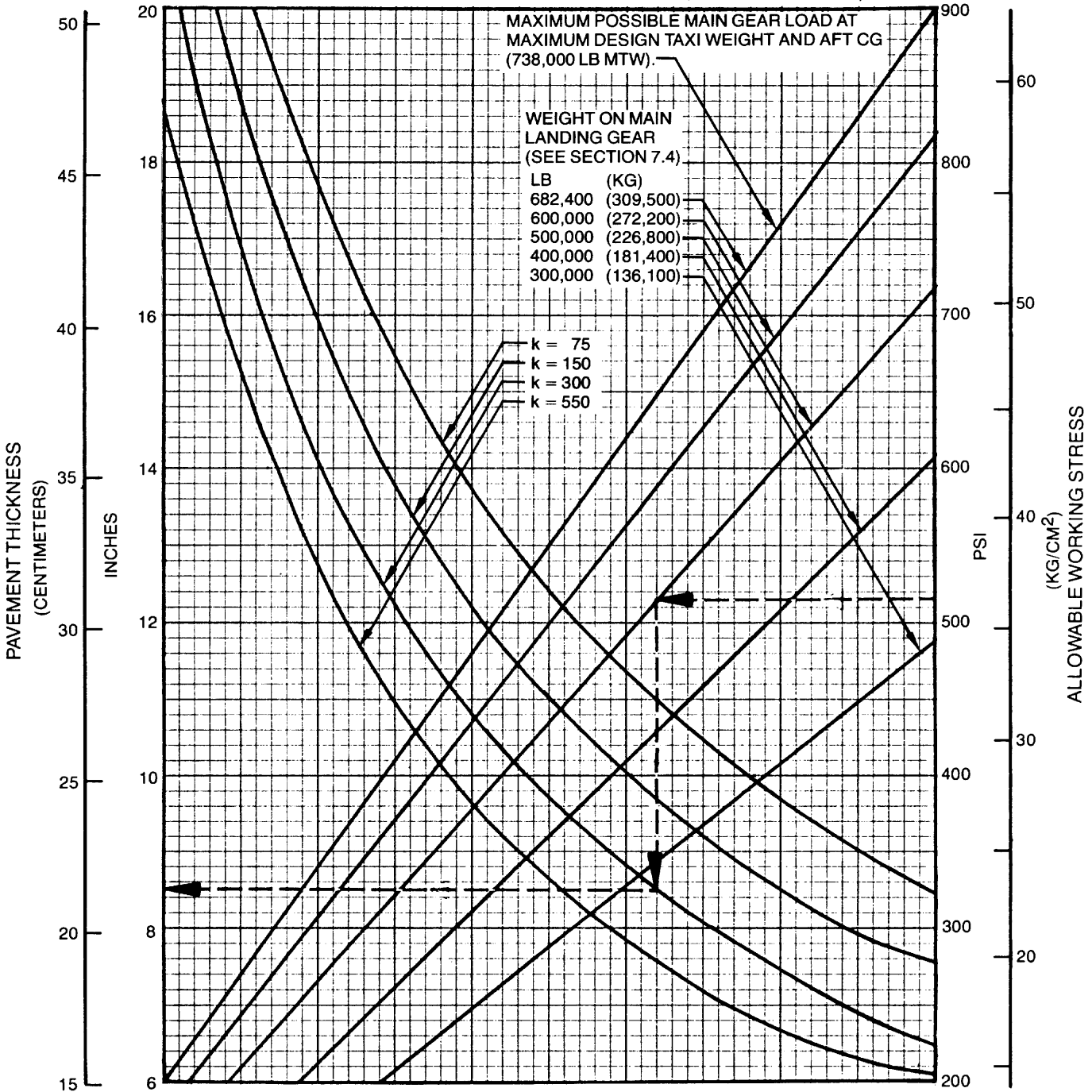

NOTE:
 THE VALUES OBTAINED BY USING THE MAXIMUM
 LOAD REFERENCE LINE AND ANY VALUE OF k
 ARE EXACT. FOR LOADS LESS THAN MAXIMUM,
 THE CURVES ARE EXACT FOR k=300 BUT
 DEVIATE SLIGHTLY FOR OTHER VALUES OF k.

REFERENCES:
 "DESIGN OF CONCRETE AIRPORT PAVEMENT"
 AND "COMPUTER PROGRAM FOR AIRPORT
 PAVEMENT DESIGN-PROGRAM PDILB,,"
 PORTLAND CEMENT ASSOCIATION.

7.7.2 RIGID-PAVEMENT REQUIREMENTS - PORTLAND CEMENT ASSOCIATION DESIGN METHOD
 MODELS 747-100B, -300 UP TO 738,000 LB (334,800 KG) MTW

- NOTES: • TIRES — 49x17 30PR; 49x17 32PR; 49x19-20 32PR; 49x19-20 34PR
 • PRESSURE RANGE FROM 188 TO 204 PSI (13.2 TO 14.4 KG/CM²)

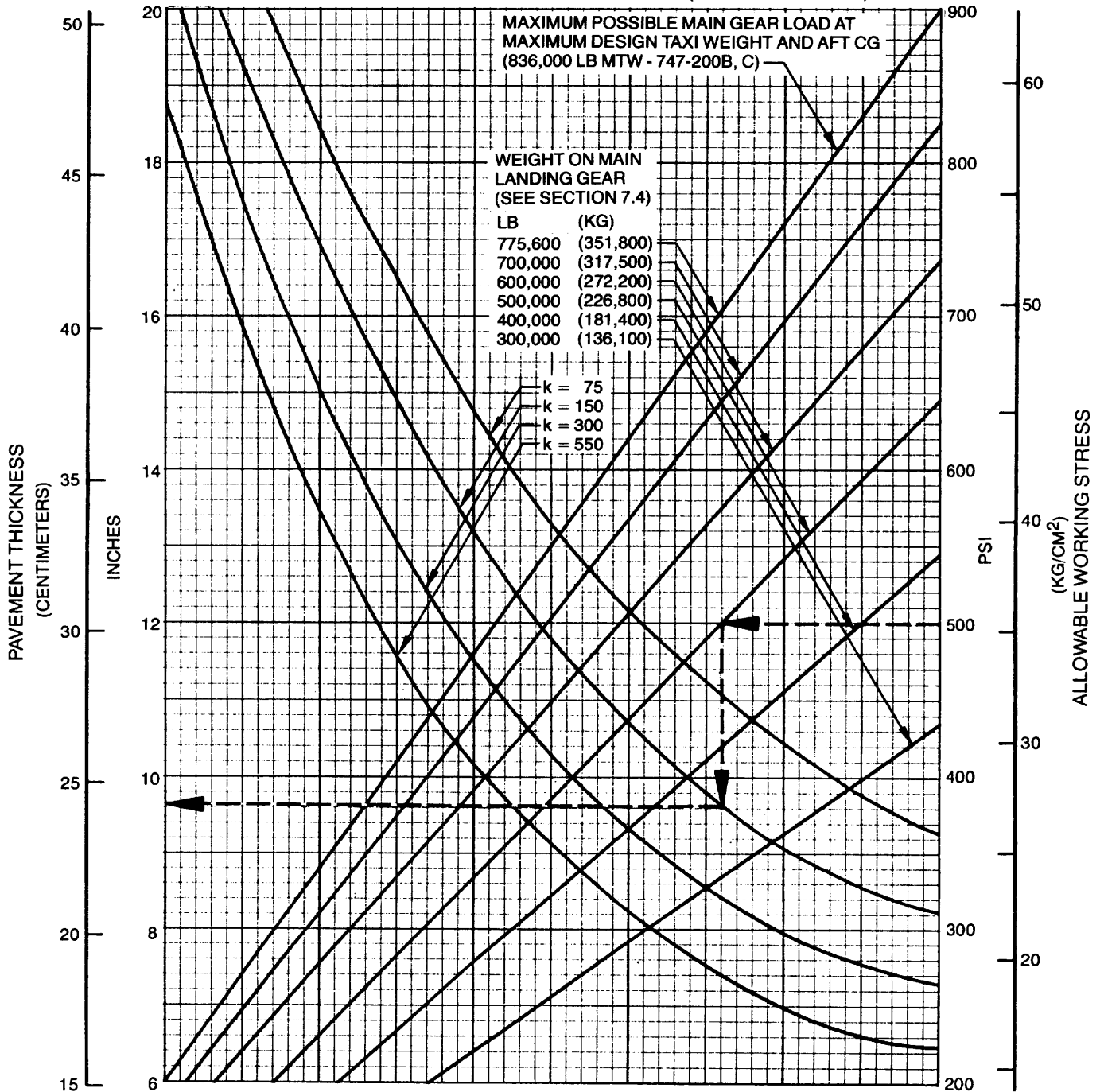

NOTE:
 THE VALUES OBTAINED BY USING THE MAXIMUM
 LOAD REFERENCE LINE AND ANY VALUE OF k
 ARE EXACT. FOR LOADS LESS THAN MAXIMUM,
 THE CURVES ARE EXACT FOR k=300 BUT
 DEVIATE SLIGHTLY FOR OTHER VALUES OF k.

REFERENCES:
 "DESIGN OF CONCRETE AIRPORT PAVEMENT"
 AND "COMPUTER PROGRAM FOR AIRPORT
 PAVEMENT DESIGN-PROGRAM PDILB,"
 PORTLAND CEMENT ASSOCIATION.

7.7.3 RIGID-PAVEMENT REQUIREMENTS-PORTLAND CEMENT ASSOCIATION DESIGN METHOD
 MODELS 747-100B, -300 AT 753,000 LB (341,600 KG) MTW AND 747-200, -300
 UP TO 836,000 LB (379,200 KG) MTW

7.8 Rigid-Pavement Requirements - LCN Conversion

To determine the airplane weight that can be accommodated on a particular rigid pavement, both the LCN of the pavement and the radius of relative stiffness k of the pavement must be known.

In the example shown on the next page the rigid-pavement radius of relative stiffness is shown at 40 with an LCN of 58. For these conditions, the apparent maximum allowable weight permissible on the main landing gear is 500,000 lb.

Note: Provided that the resultant airplane LCN is not more than 10% above the published pavement LCN, the bearing strength of the pavement can be considered sufficient for unlimited use by the airplane. The figure of 10% has been chosen as representing the lowest degree of variation of LCN that is significant (reference: ICAO Aerodrome Manual, Part 2, "Aerodrome Physical Characteristics," Chapter 4, Paragraph 4.1.5.7v, 2nd Edition dated 1965).

RADIUS OF RELATIVE STIFFNESS ℓ

VALUES IN INCHES

$$\text{RADIUS OF RELATIVE STIFFNESS, } \ell = \sqrt[4]{\frac{E d^3}{12(1-\mu^2)k}} = 24.1652 \sqrt[4]{\frac{d^3}{k}}$$

WHERE: E = YOUNG'S MODULUS = 4×10^6 PSI
 k = SUBGRADE MODULUS (LB/IN.³)
 d = RIGID-PAVEMENT THICKNESS (INCHES)
 μ = POISSON'S RATIO = 0.15

d(IN.)	k=50	k=100	k=150	k=200	k=250	k=300	k=350	k=400	k=500
6	34.84	29.30	26.47	24.63	23.30	22.26	21.42	20.72	19.59
6.5	36.99	31.11	28.11	26.16	24.74	23.64	22.74	22.00	20.80
7	39.11	32.89	29.72	27.65	26.15	24.99	24.04	23.25	21.99
7.5	41.19	34.63	31.29	29.12	27.54	26.32	25.32	24.49	23.16
8	43.23	36.35	32.85	30.57	28.91	27.62	26.58	25.70	24.31
8.5	45.24	38.04	34.37	31.99	30.25	28.91	27.81	26.90	25.44
9	47.22	39.71	35.88	33.39	31.58	30.17	29.03	28.08	26.55
9.5	49.17	41.35	37.36	34.77	32.89	31.42	30.23	29.24	27.65
10	51.10	42.97	38.83	36.14	34.17	32.65	31.42	30.39	28.74
10.5	53.01	44.57	40.28	37.48	35.45	33.87	32.59	31.52	29.81
11	54.89	46.16	41.71	38.81	36.71	35.07	33.75	32.64	30.87
11.5	56.75	47.72	43.12	40.13	37.95	36.26	34.89	33.74	31.91
12	58.59	49.27	44.52	41.43	39.18	37.44	36.02	34.84	32.95
12.5	60.41	50.80	45.90	42.72	40.40	38.60	37.14	35.92	33.97
13	62.22	52.32	47.27	43.99	41.61	39.75	38.25	36.99	34.99
13.5	64.00	53.82	48.63	45.26	42.80	40.89	39.35	38.06	35.99
14	65.77	55.31	49.98	46.51	43.98	42.02	40.44	39.11	36.99
14.5	67.53	56.78	51.31	47.75	45.16	43.15	41.51	40.15	37.97
15	69.27	58.25	52.63	48.98	46.32	44.26	42.58	41.19	38.95
15.5	70.99	59.70	53.94	50.20	47.47	45.36	43.64	42.21	39.92
16	72.70	61.13	55.24	51.41	48.62	46.45	44.70	43.23	40.88
16.5	74.40	62.56	56.53	52.61	49.75	47.54	45.74	44.24	41.84
17	76.08	63.98	57.81	53.80	50.88	48.61	46.77	45.24	42.78
17.5	77.75	65.38	59.48	54.98	52.00	49.68	47.80	46.23	43.72
18	79.41	66.78	60.35	56.16	53.11	50.74	48.82	47.22	44.66
19	82.70	69.54	62.84	58.48	55.31	52.84	50.84	49.17	46.51
20	85.95	72.27	65.30	60.77	57.47	54.92	52.84	51.10	48.33
21	89.15	74.97	67.74	63.04	59.62	56.96	54.81	53.01	50.13
22	92.31	77.63	70.14	65.28	61.73	58.98	56.75	54.89	51.91
23	95.44	80.26	72.52	67.49	63.83	60.98	58.68	56.75	53.67
24	98.54	82.86	74.87	69.68	65.90	62.96	60.58	58.59	55.41

7.8.1 RADIUS OF RELATIVE STIFFNESS (REFERENCE: PORTLAND CEMENT ASSOCIATION)

- NOTES:
- TIRES — 49x17 28PR; 49x17 30PR
 - PRESSURE RANGE FROM 151 TO 162 PSI (10.6 TO 11.4 KG/CM²)
 - EQUIVALENT SINGLE-WHEEL LOADS ARE DERIVED BY METHODS SHOWN IN ICAO AERODROME MANUAL, PART 2, PAR. 4.1.3. DATED 1965

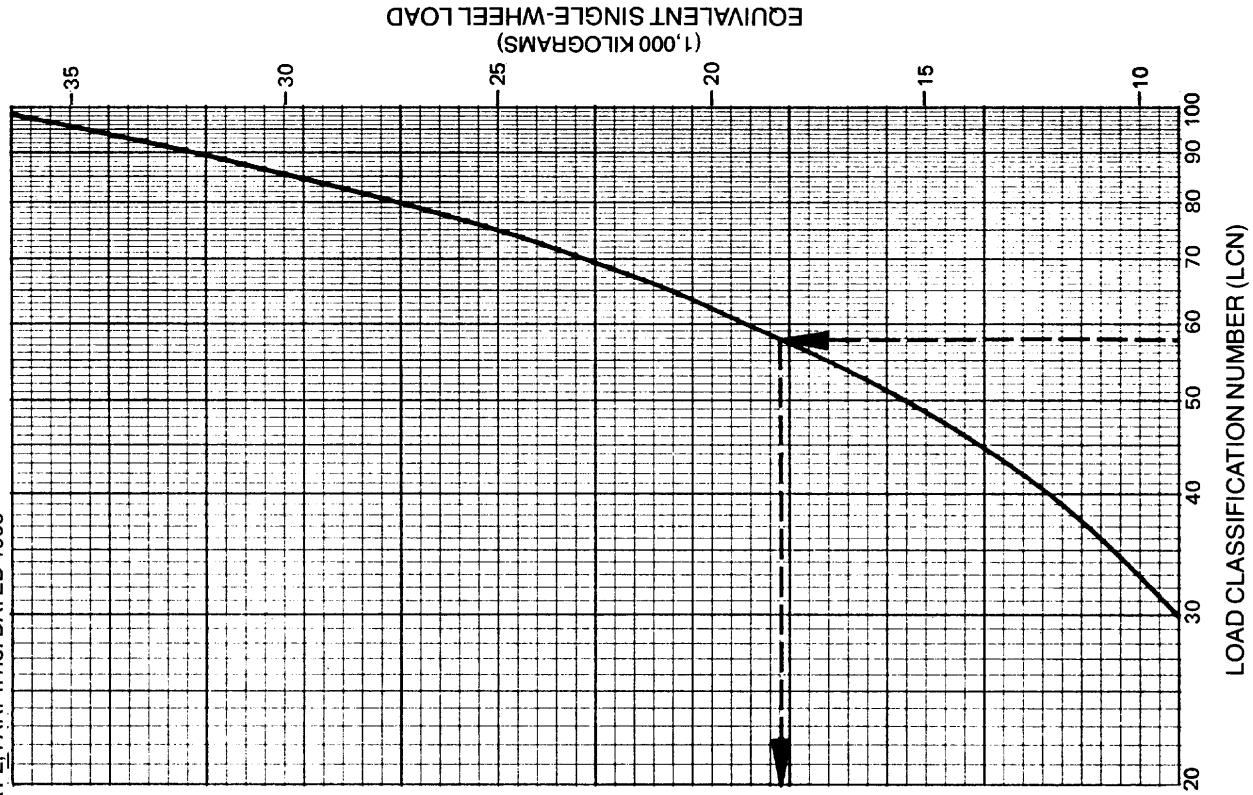
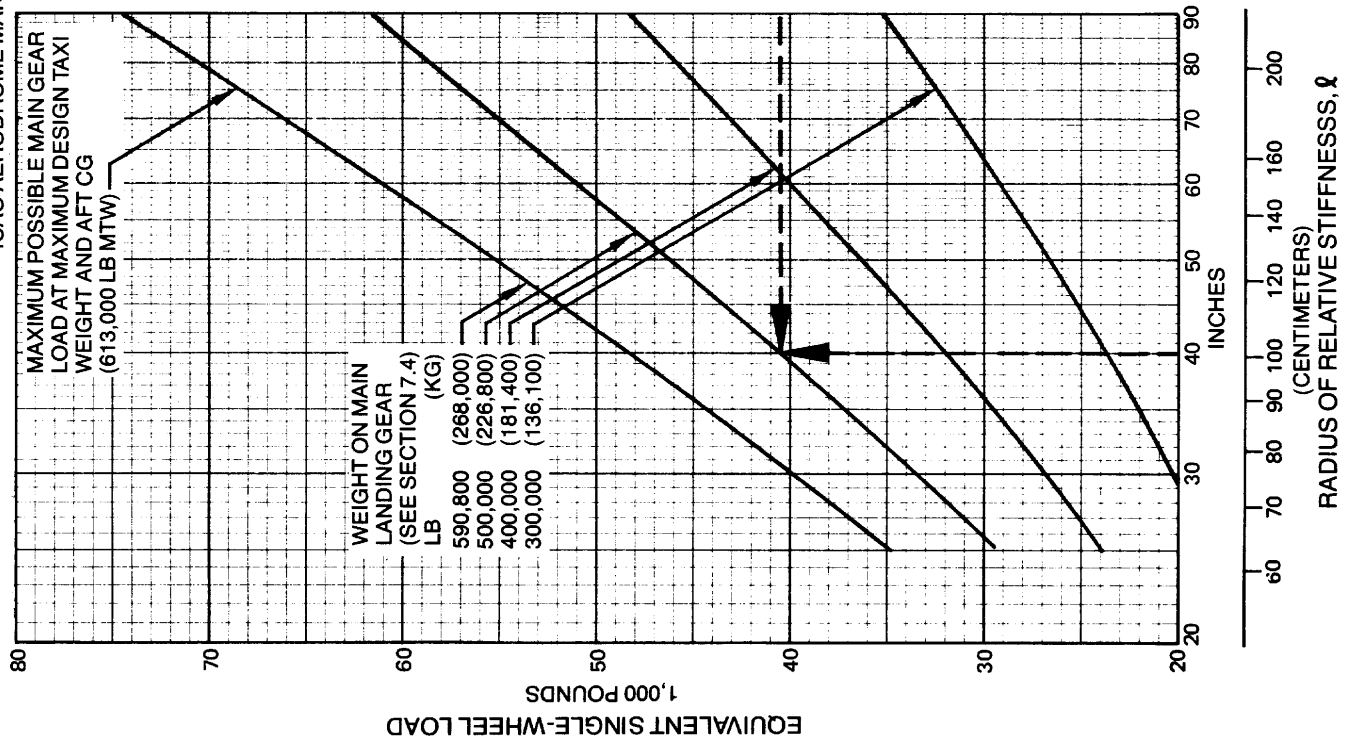

7.8.2 RIGID-PAVEMENT REQUIREMENTS — LCN CONVERSION

MODELS 747-100B SR, -300 SR; UP TO 613,000 LB (278,100 KG) MTW

- NOTES:
- TIRES — 46x16 30PR
 - PRESSURE RANGE FROM 217 TO 219 PSI (15.3 TO 15.4 KG/CM²)
 - EQUIVALENT SINGLE-WHEEL LOADS ARE DERIVED BY METHODS SHOWN IN ICAO AERODROME MANUAL, PART 2, PAR. 4.1.3, DATED 1965

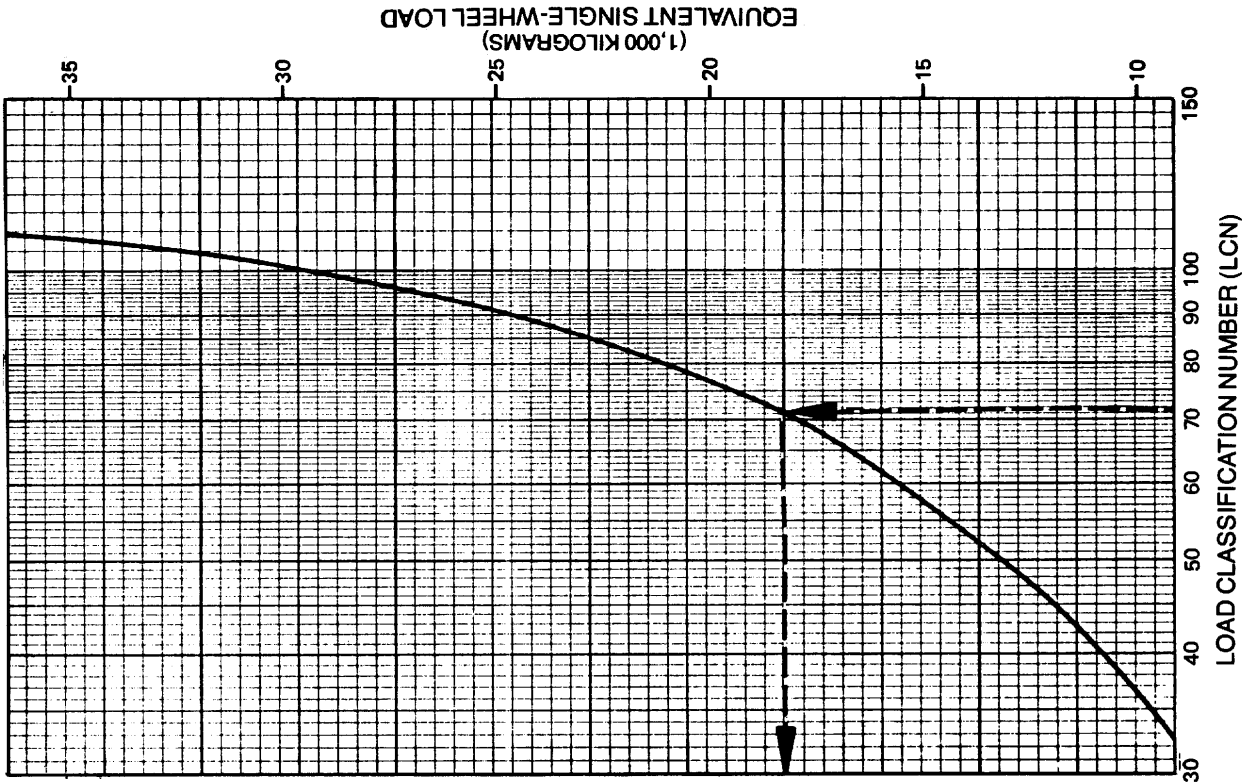
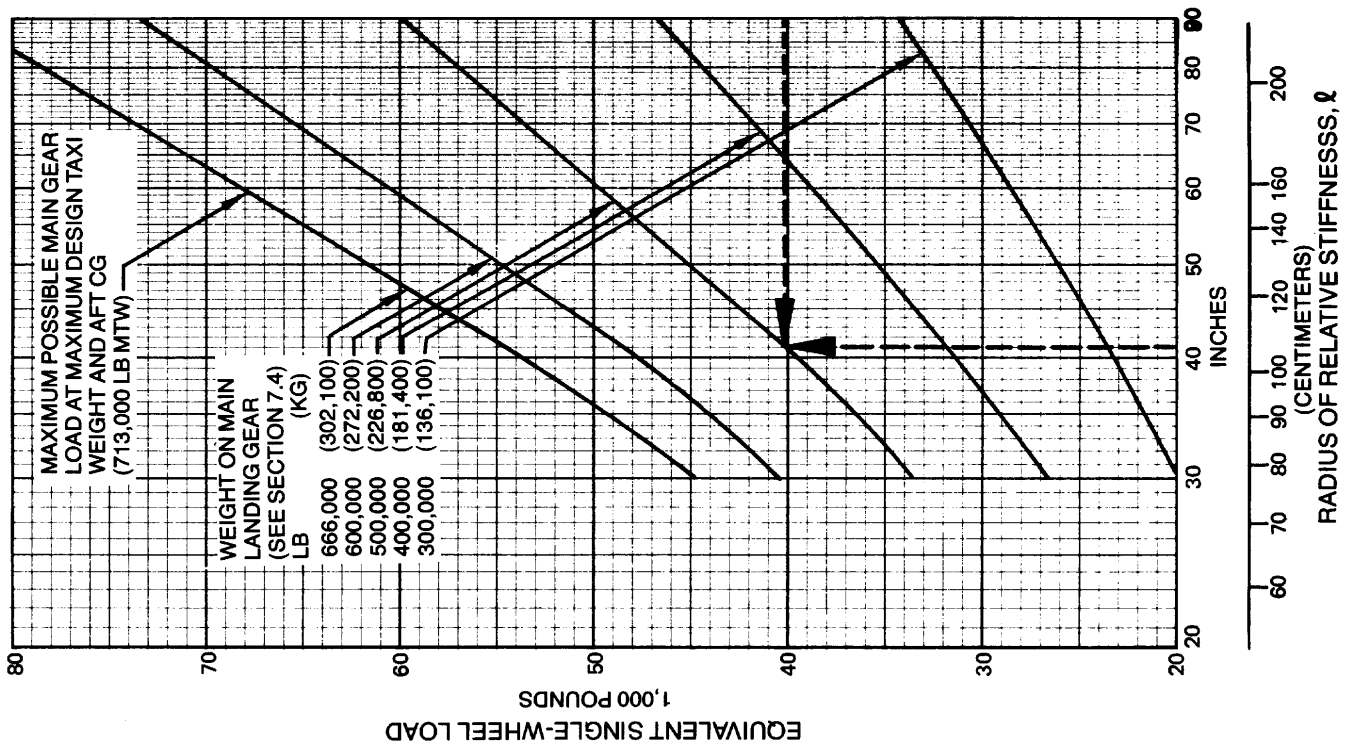

7.8.3 RIGID-PAVEMENT REQUIREMENTS — LCN CONVERSION MODELS 747-100B, -300 AT 713,000 LB (323,400 KG) MTW

- NOTES:
- TIRES — 46x16 30PR; 46x16 32PR
 - PRESSURE RANGE FROM 226 TO 232 PSI (15.9 TO 16.3 KG/CM²)
 - EQUIVALENT SINGLE-WHEEL LOADS ARE DERIVED BY METHODS SHOWN IN ICAO AERODROME MANUAL, PART 2, PAR. 4.1.3. DATED 1965

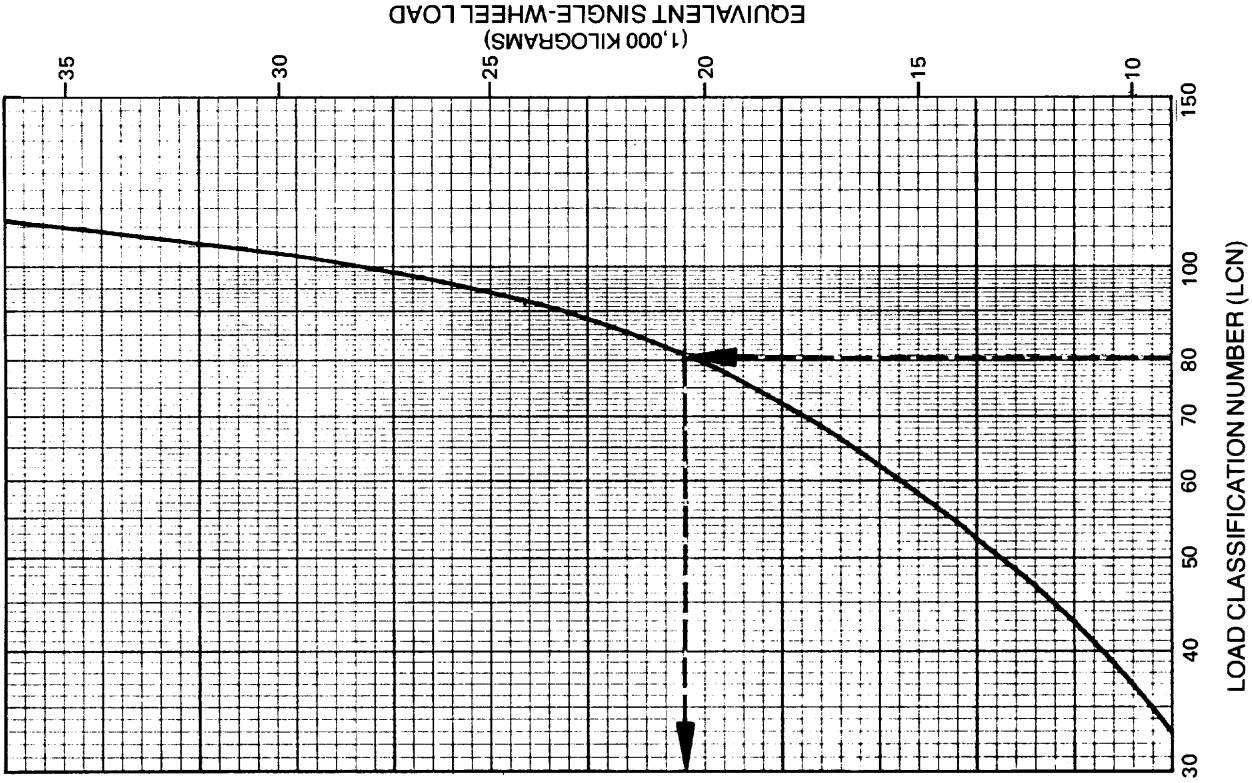
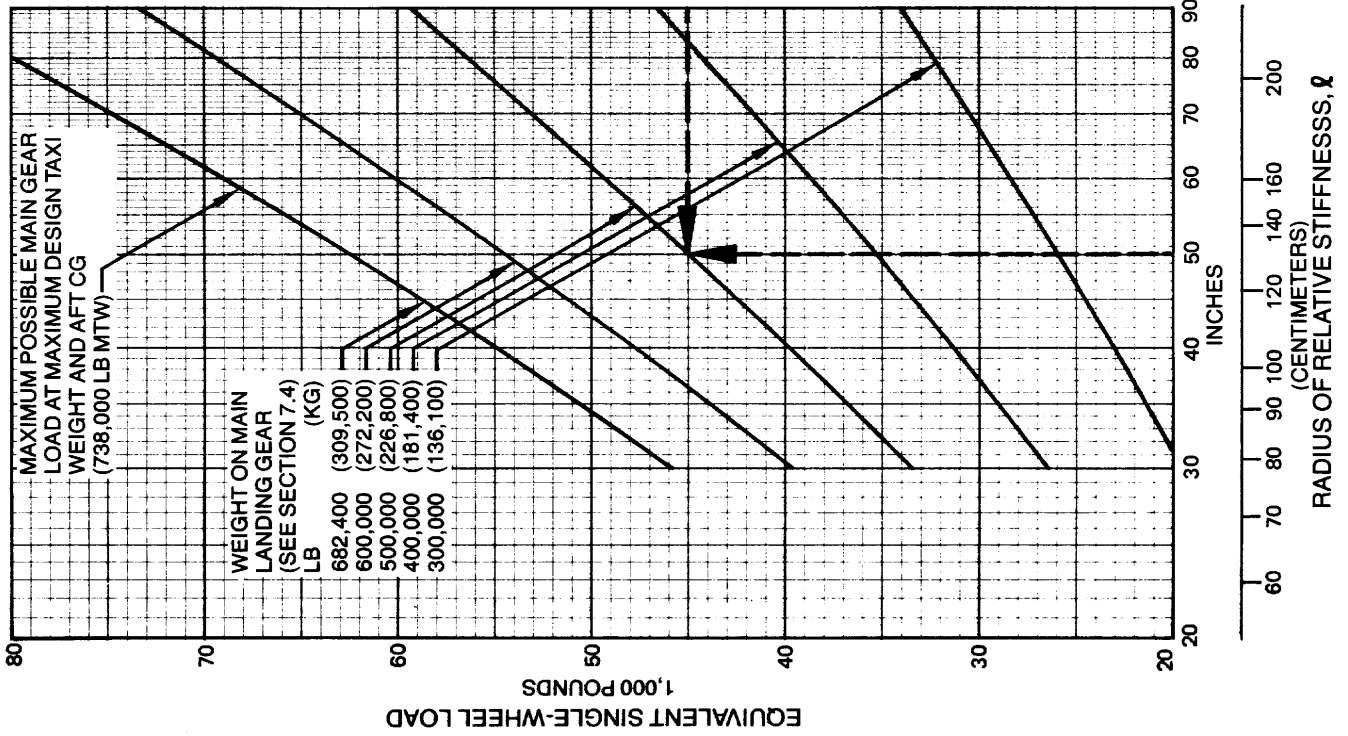

7.8.4 RIGID-PAVEMENT REQUIREMENTS — LCN CONVERSION
MODELS 747-100B, -300 AT 738,000 LB (334,800 KG) MTW

- NOTES:
- TIRES — 49x19-20 34PR; 49x17 30PR; 49x17 32PR; 49x19-20 32PR
 - PRESSURE RANGE FROM 188 TO 192 PSI (13.2 TO 13.5 KG/CM²)
 - EQUIVALENT SINGLE-WHEEL LOADS ARE DERIVED BY METHODS SHOWN IN ICAO AERODROME MANUAL, PART 2, PAR. 4.1.3, DATED 1965

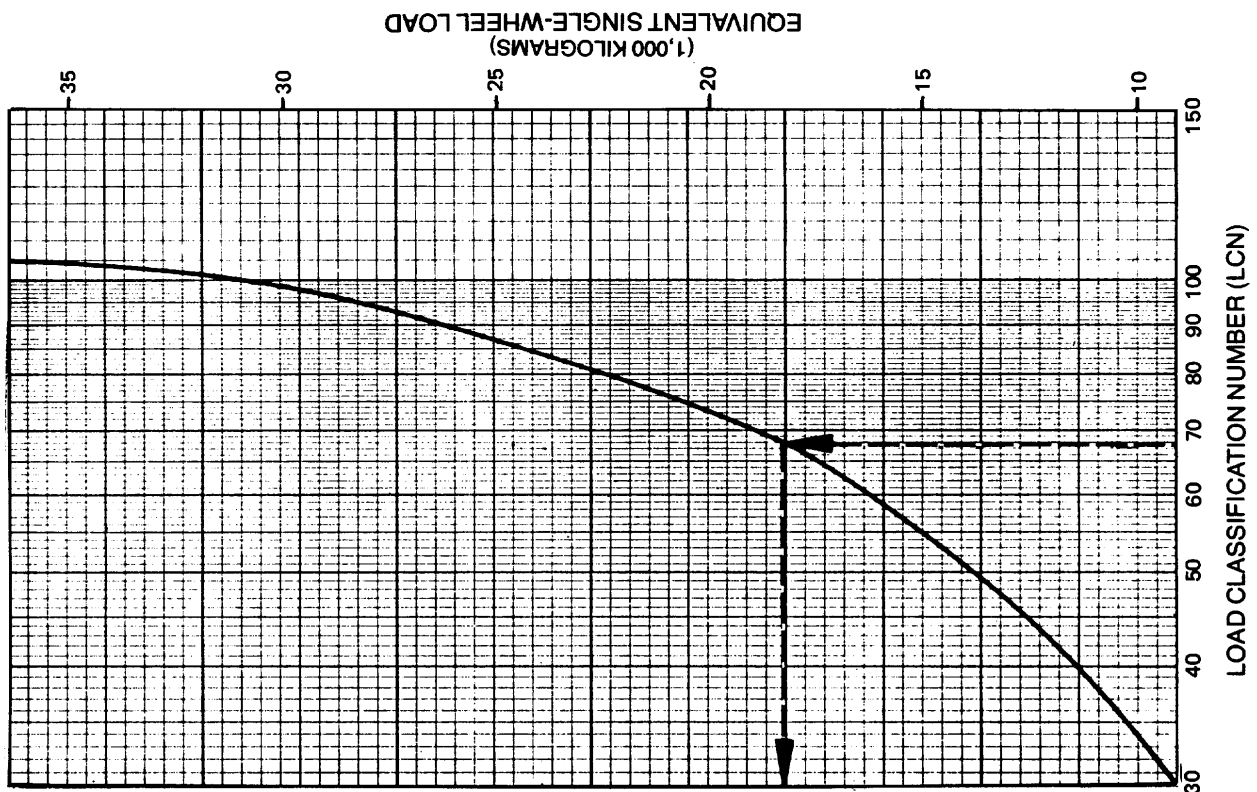
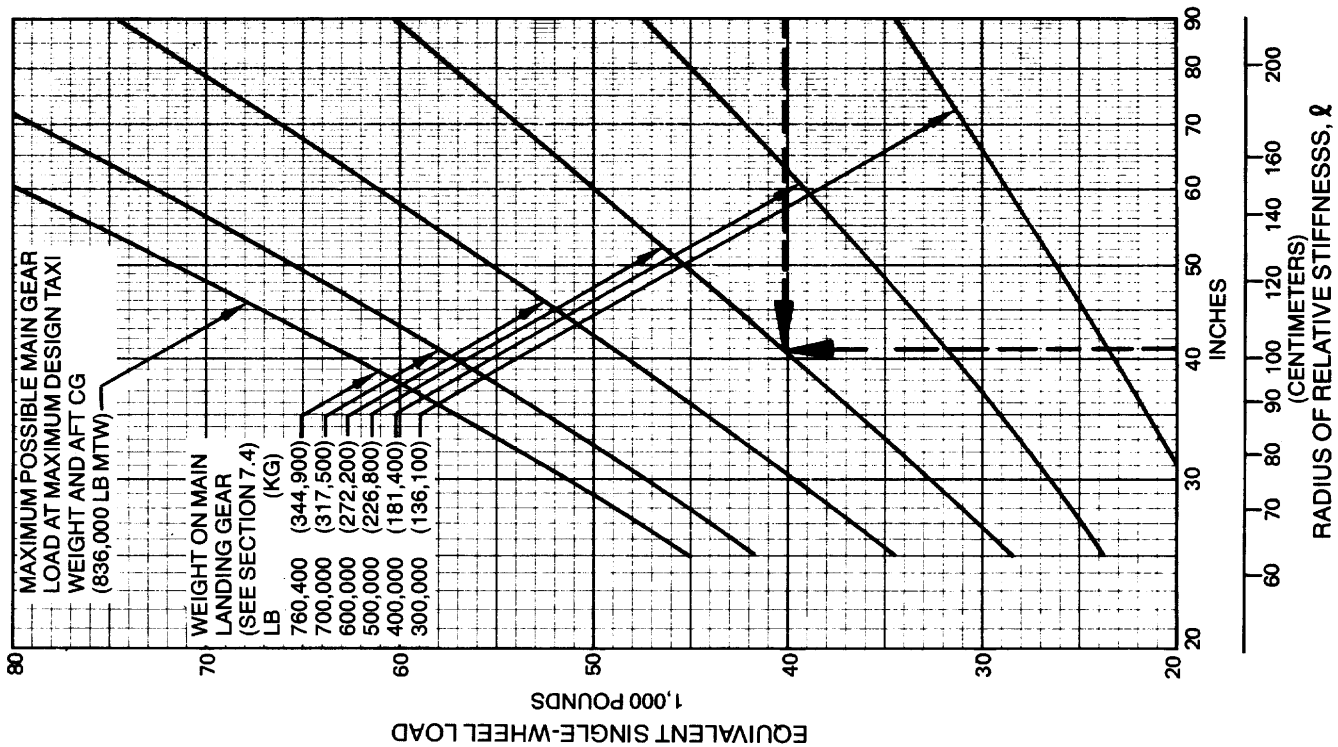

7.8.5 RIGID-PAVEMENT REQUIREMENTS — LCN CONVERSION

MODELS 747-100B, -300 AT 753,000 LB (341,600 KG) MTW AND 747-200, -300 AT 823,000 LB (373,300 KG) TO 836,000 LB (379,200 KG) MTW

- NOTES:
- TIRES — 49x17 30PR; 49x17 32PR
 - PRESSURE RANGE FROM 198 TO 205 PSI (13.9 TO 14.4 KG/CM²)
 - EQUIVALENT SINGLE-WHEEL LOADS ARE DERIVED BY METHODS SHOWN IN ICAO AERODROME MANUAL, PART 2, PAR. 4.1.3. DATED 1965

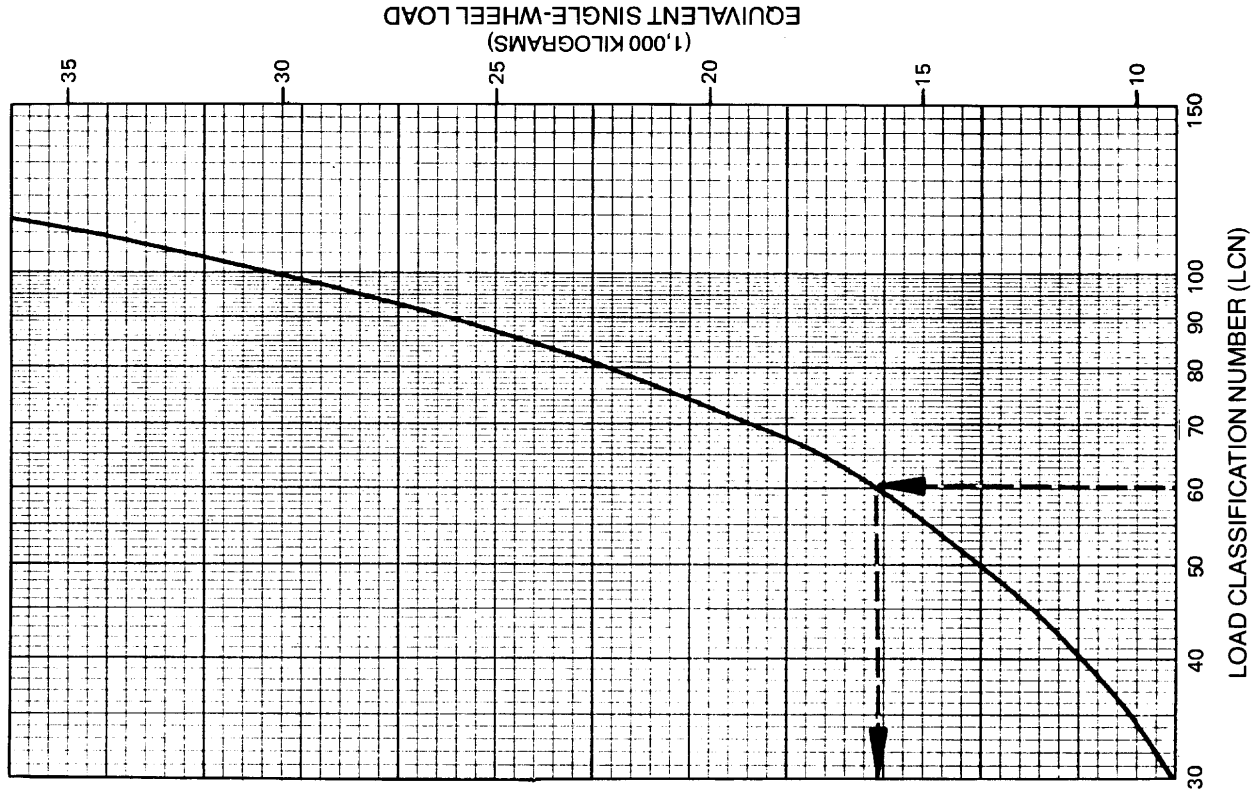
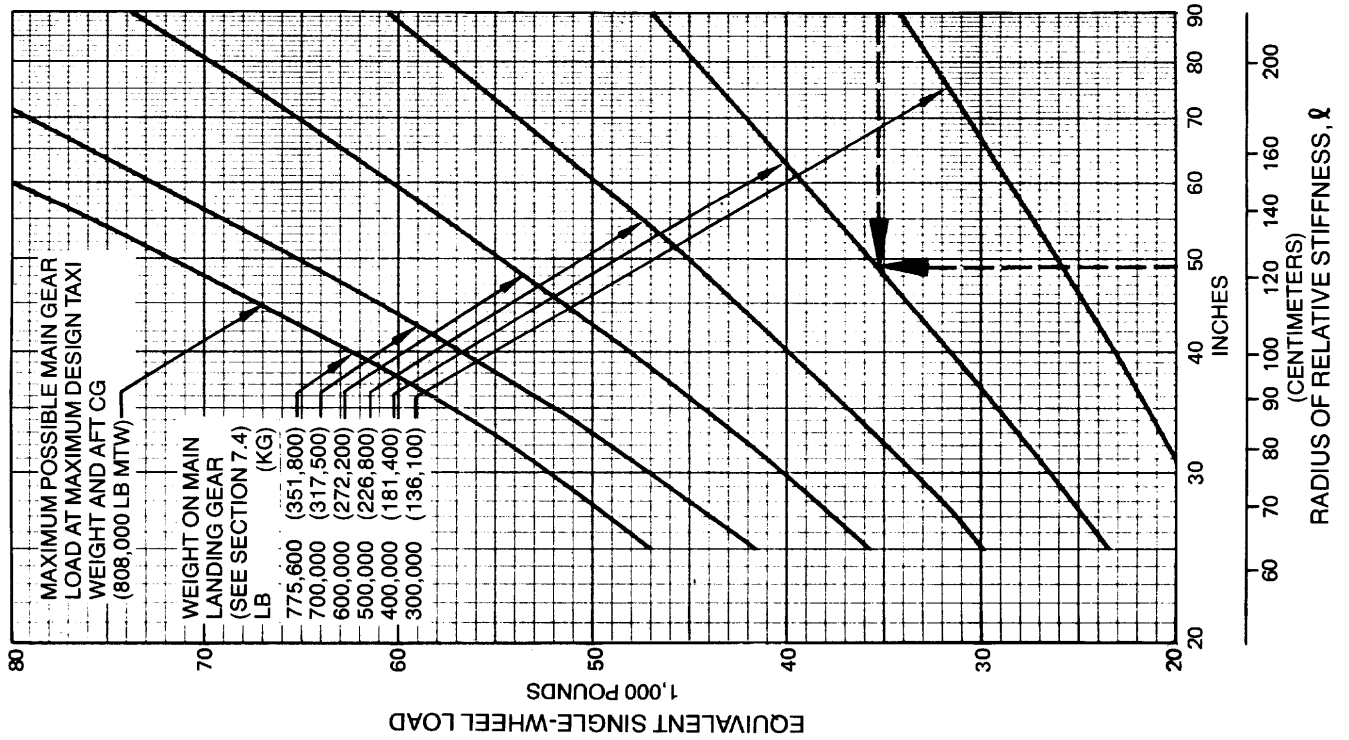

7.8.6 RIGID-PAVEMENT REQUIREMENTS — LCN CONVERSION
 MODELS 747-200, -300; UP TO 808,000 LB (366,500 KG) MTW

- NOTES:
- TIRES — 46x16 26PR; 46x16 28PR; 46x16 30PR
 - PRESSURE RANGE FROM 188 TO 203 PSI (13.22 to 14.27 KG/CM²)
 - EQUIVALENT SINGLE-WHEEL LOADS ARE DERIVED BY METHODS SHOWN IN ICAO AERODROME MANUAL, PART 2, PAR. 4.1.3, DATED 1965

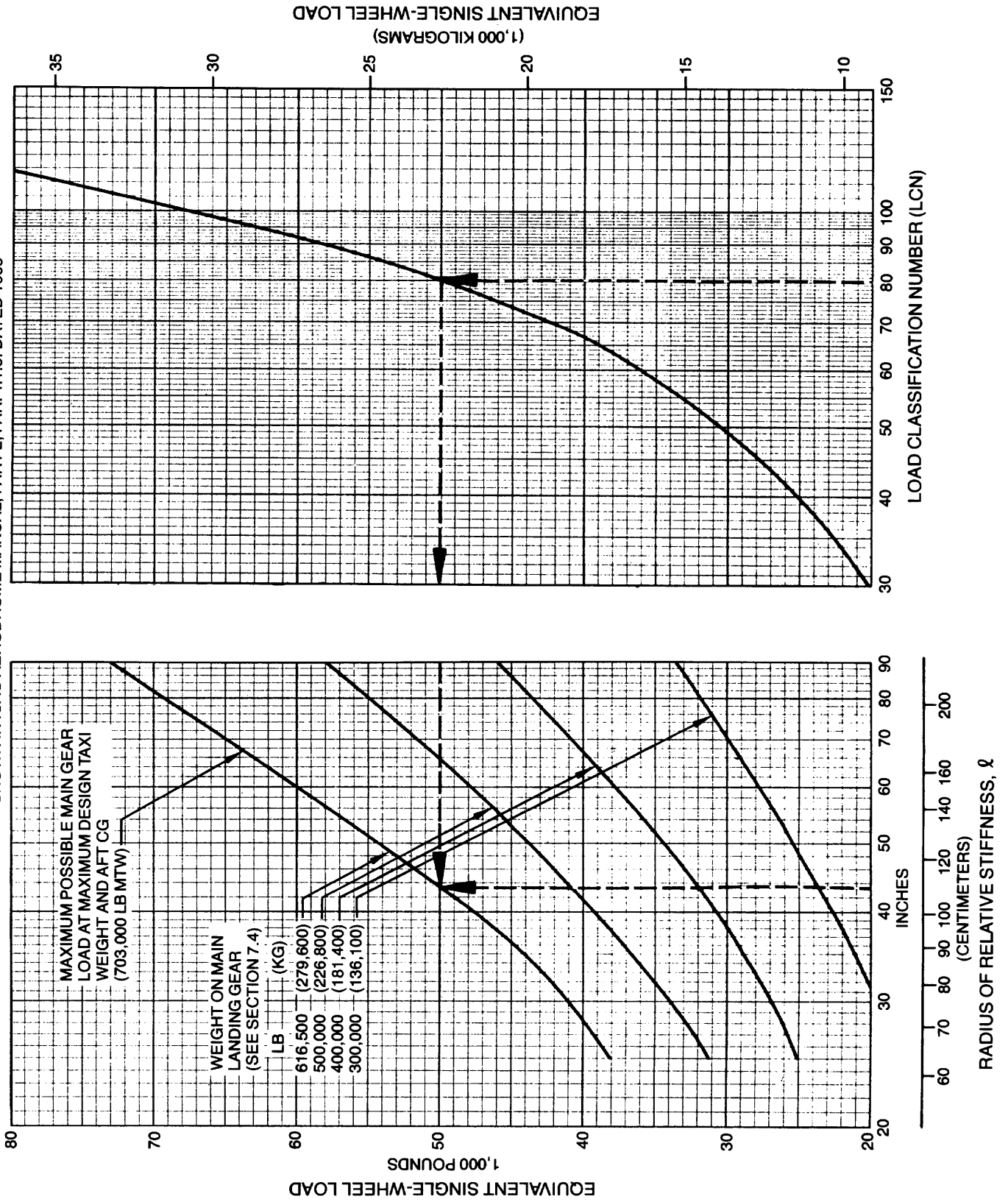

7.8.7 RIGID-PAVEMENT REQUIREMENTS — LCN CONVERSION
MODELS 747SP UP TO 703,000 LB (318,800 KG) MTW

D6-58326

MAY 1984

219

7.9 Rigid-Pavement Requirements-FAA Design Method

To determine the airplane weight that can be accommodated on a particular rigid pavement, the pavement flexural strength, the subgrade strength (k), and the number of annual departures must be known.

In the example shown, the pavement flexural strength is shown at 700 psi, the subgrade strength is shown at $k = 300$, and the annual departure level is 3,000. For these conditions, the required rigid-pavement thickness for an airplane with a main-gear load of 700,000 lb is 11.8 in.

NOTE: ALL TIRES — CONTACT AREA CONSTANT AT 264 IN.² (0.170 M²)

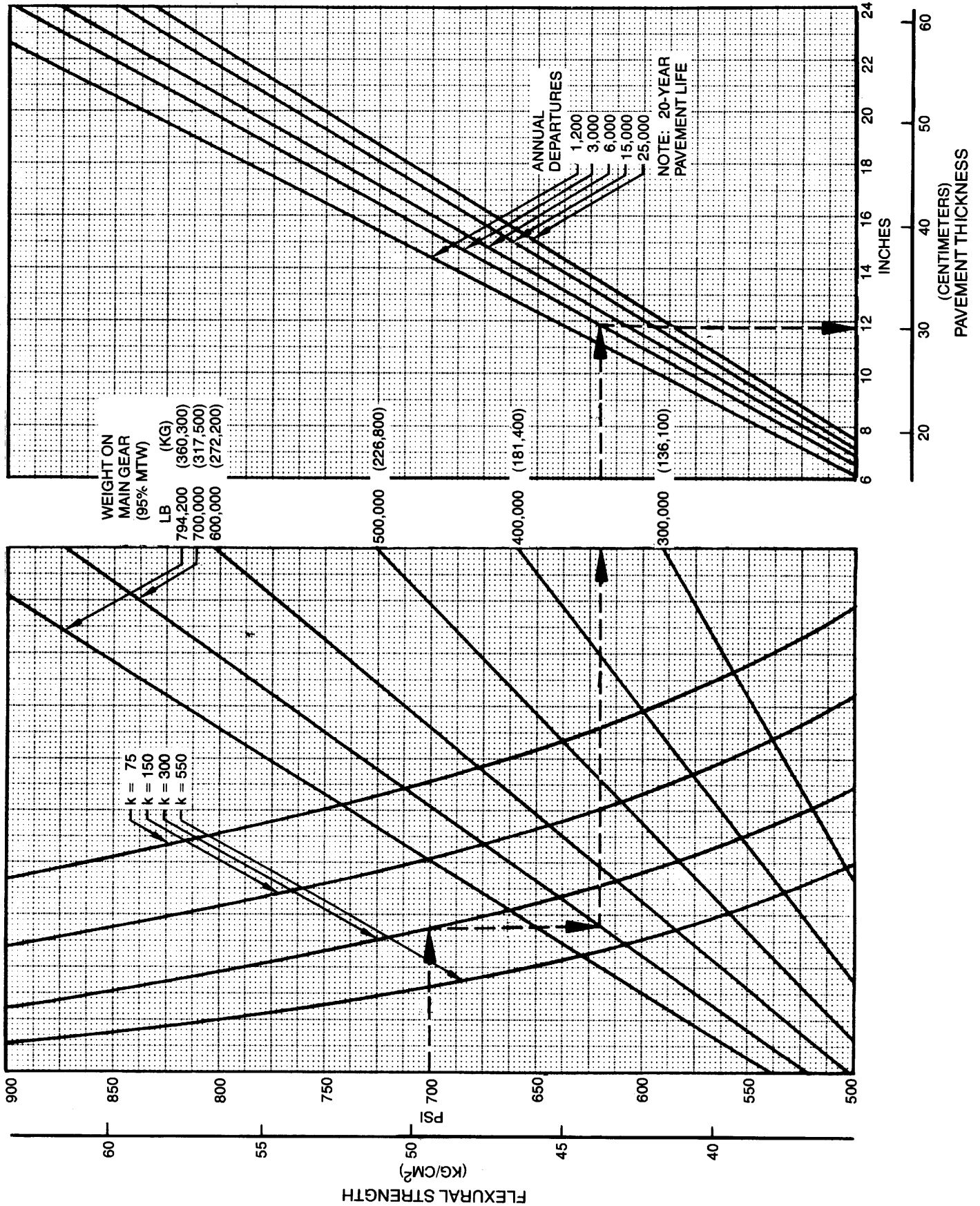

7.9.1 RIGID-PAVEMENT REQUIREMENTS - FAA METHOD
 MODELS 747-100B, -200, -300

NOTE: ALL TIRES — CONTACT AREA CONSTANT AT 212 IN.² (0.137 M²)

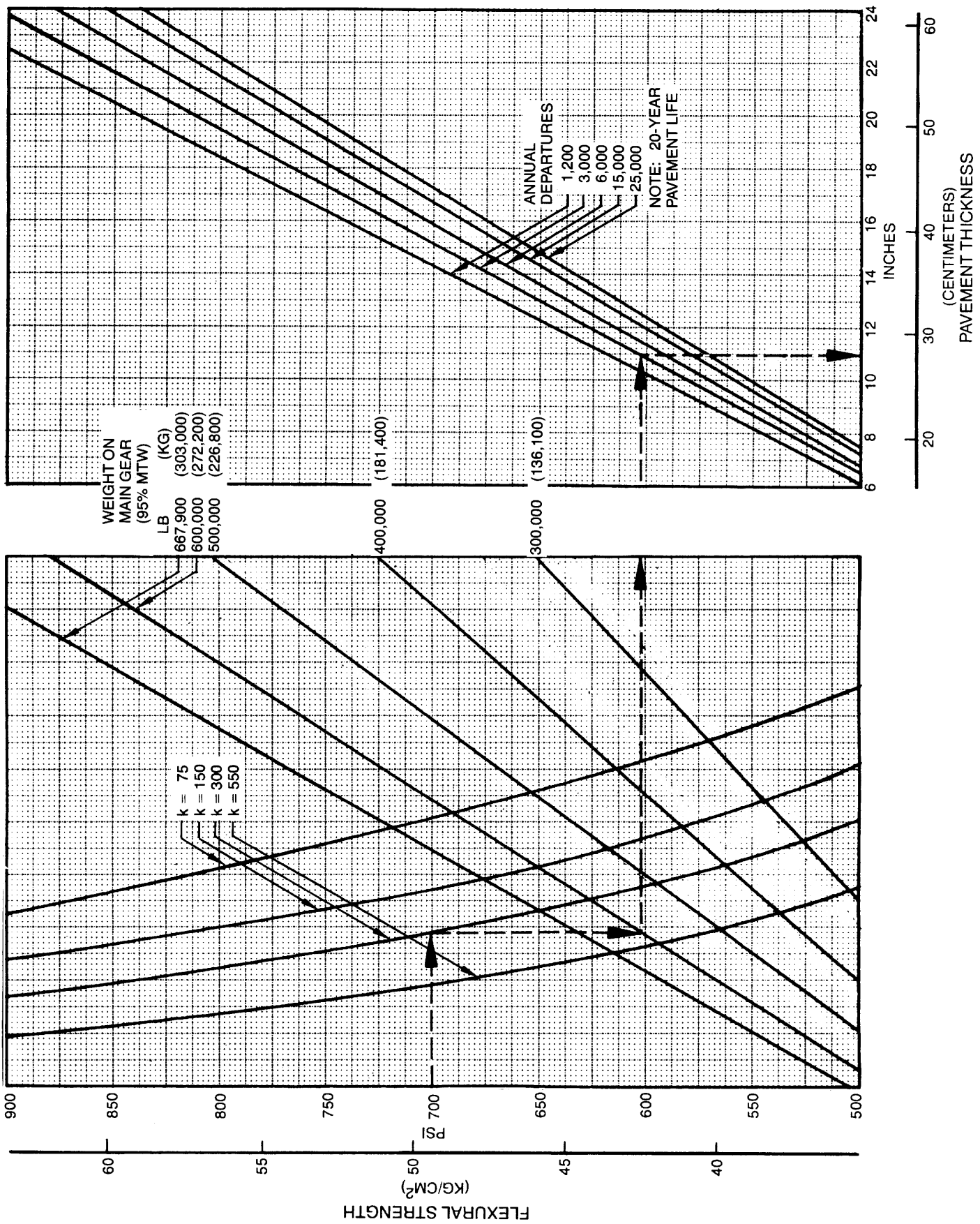

7.9.2 RIGID-PAVEMENT REQUIREMENTS - FAA METHOD
MODEL 747SP

7.10 ACN/PCN Reporting System: Flexible and Rigid Pavements

To determine the ACN of an aircraft on flexible or rigid pavement, both the aircraft gross weight and the subgrade strength category must be known. In the chart in Section 7.10.1, for example, for an aircraft with gross weight of 540,000 lb and ultra-low subgrade strength, the flexible pavement ACN is 47. Referring to 7.10.3 for the same gross weight and subgrade strength, the ACN for rigid pavement is 44.

Note: An aircraft with an ACN equal to or less than the reported PCN can operate on the pavement subject to any limitations on the tire pressure. (Ref.: Amendment 35 to ICAO Annex 14 Aerodromes, 7th Edition, June 1976).

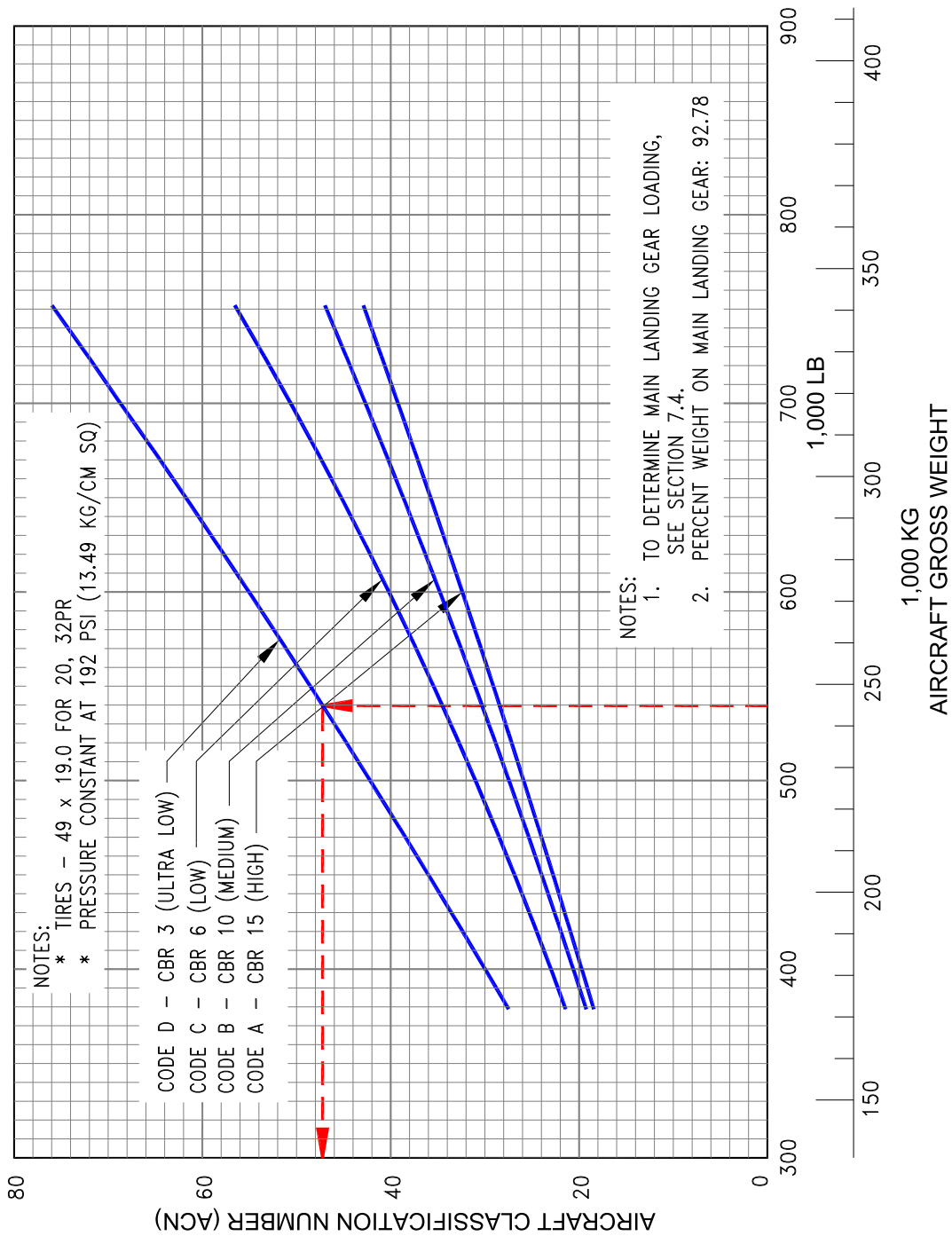

7.10.1 AIRCRAFT CLASSIFICATION NUMBER - FLEXIBLE PAVEMENT
 MODEL 747-100

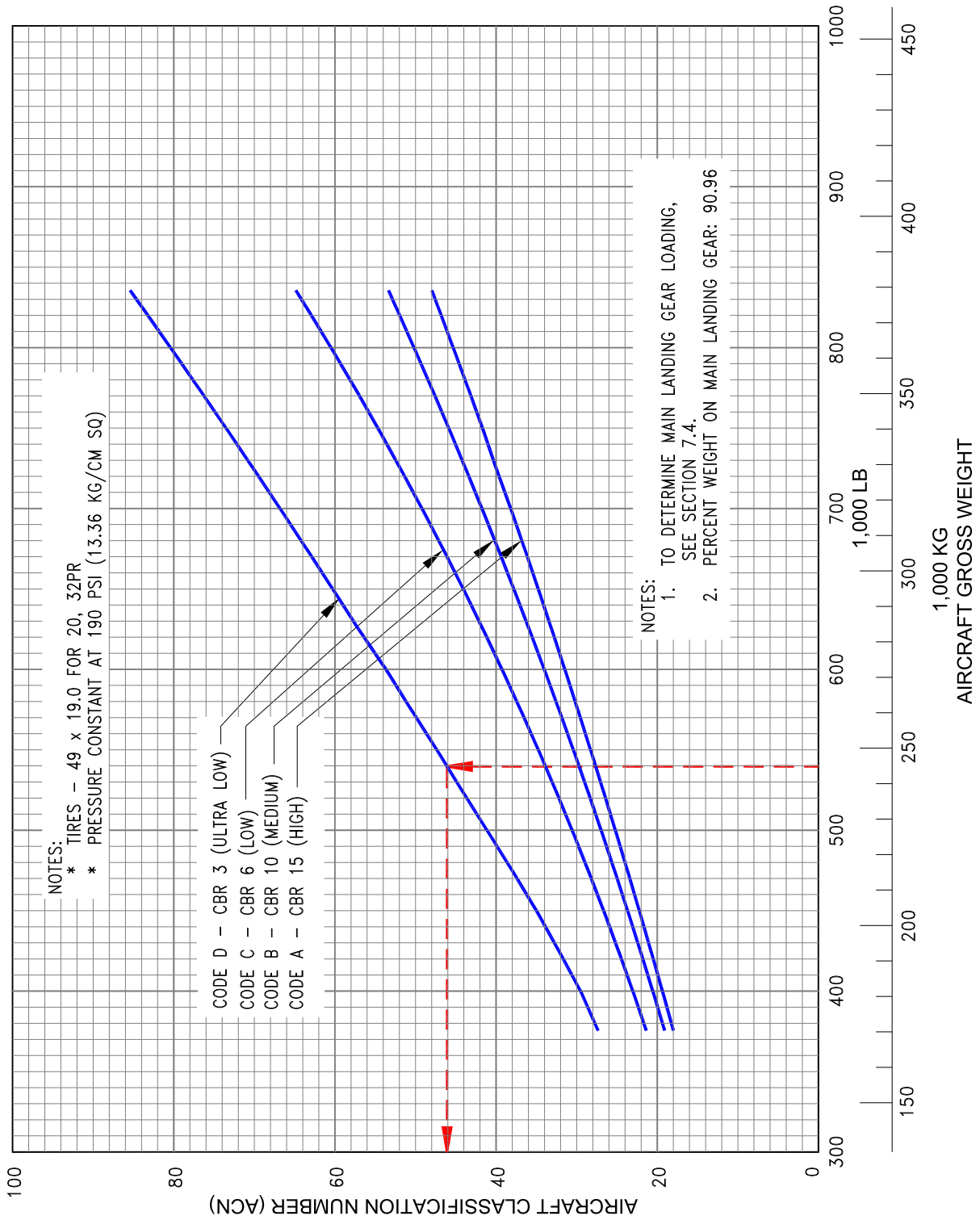

7.10.1 AIRCRAFT CLASSIFICATION NUMBER - FLEXIBLE PAVEMENT
 MODELS 747-200, -300

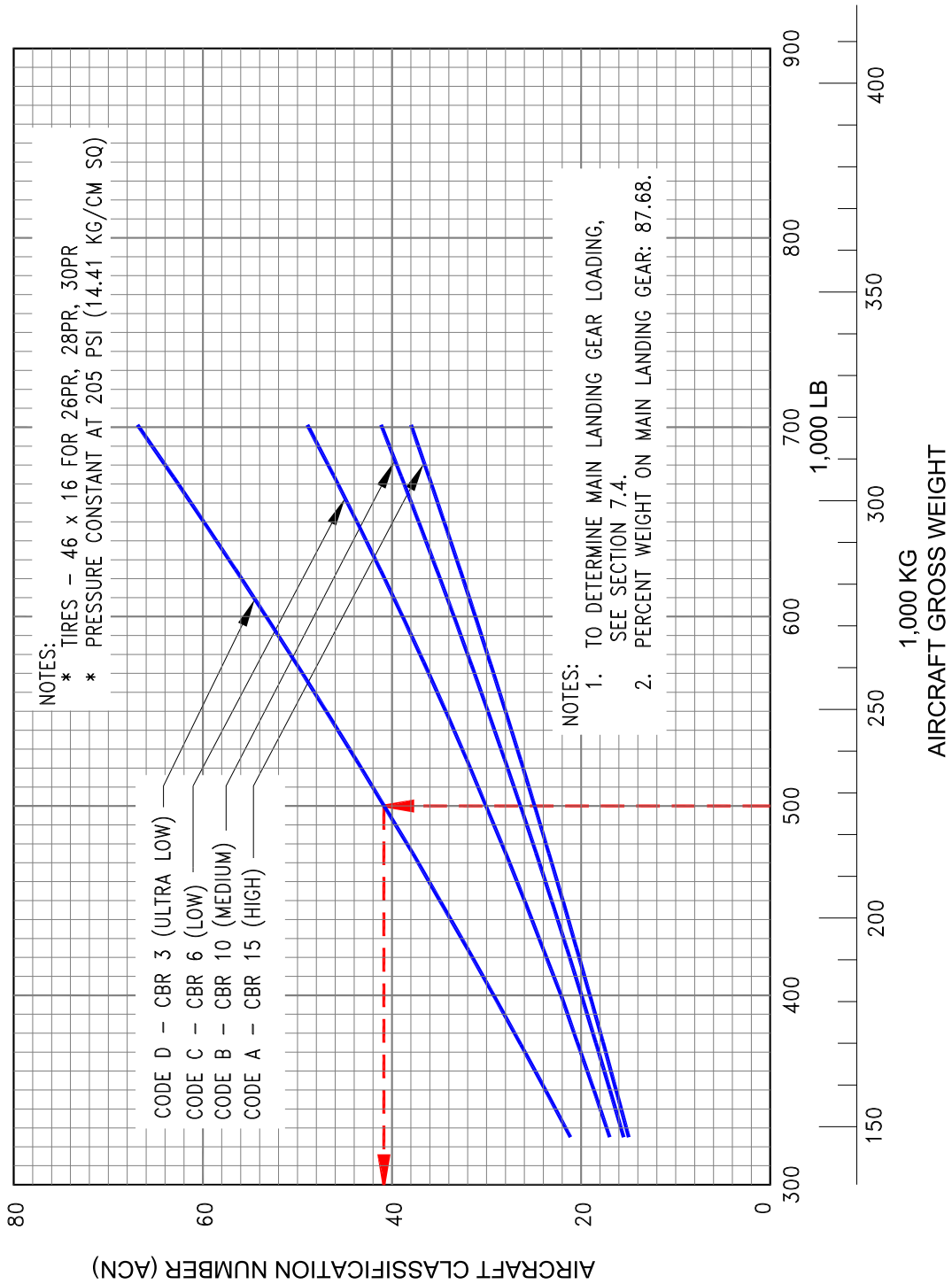

7.10.2 AIRCRAFT CLASSIFICATION NUMBER - FLEXIBLE PAVEMENT
 MODEL 747SP

- NOTES:
- TIRES - 49x19-20 32 PR
 - PRESSURE CONSTANT AT 188 PSI (13.22 KG/CM²)

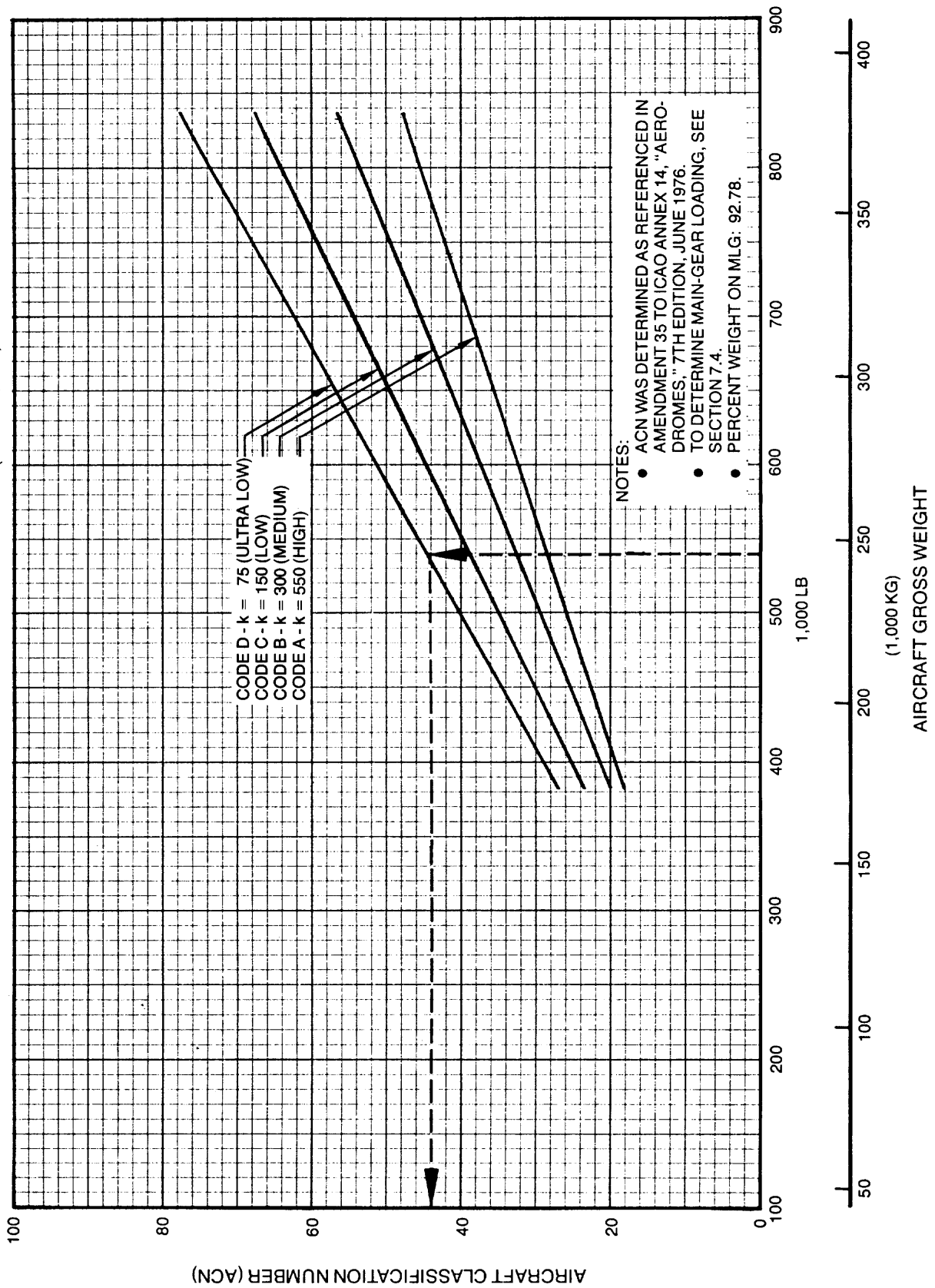

7.10.3 AIRCRAFT CLASSIFICATION NUMBER - RIGID PAVEMENT
 MODELS 747-100, -200, -300

- NOTES:
- TIRES — 46x16 26PR; 46x16 28PR; 46x16 30PR
 - PRESSURE CONSTANT AT 196 PSI (13.78 KG/CM²)

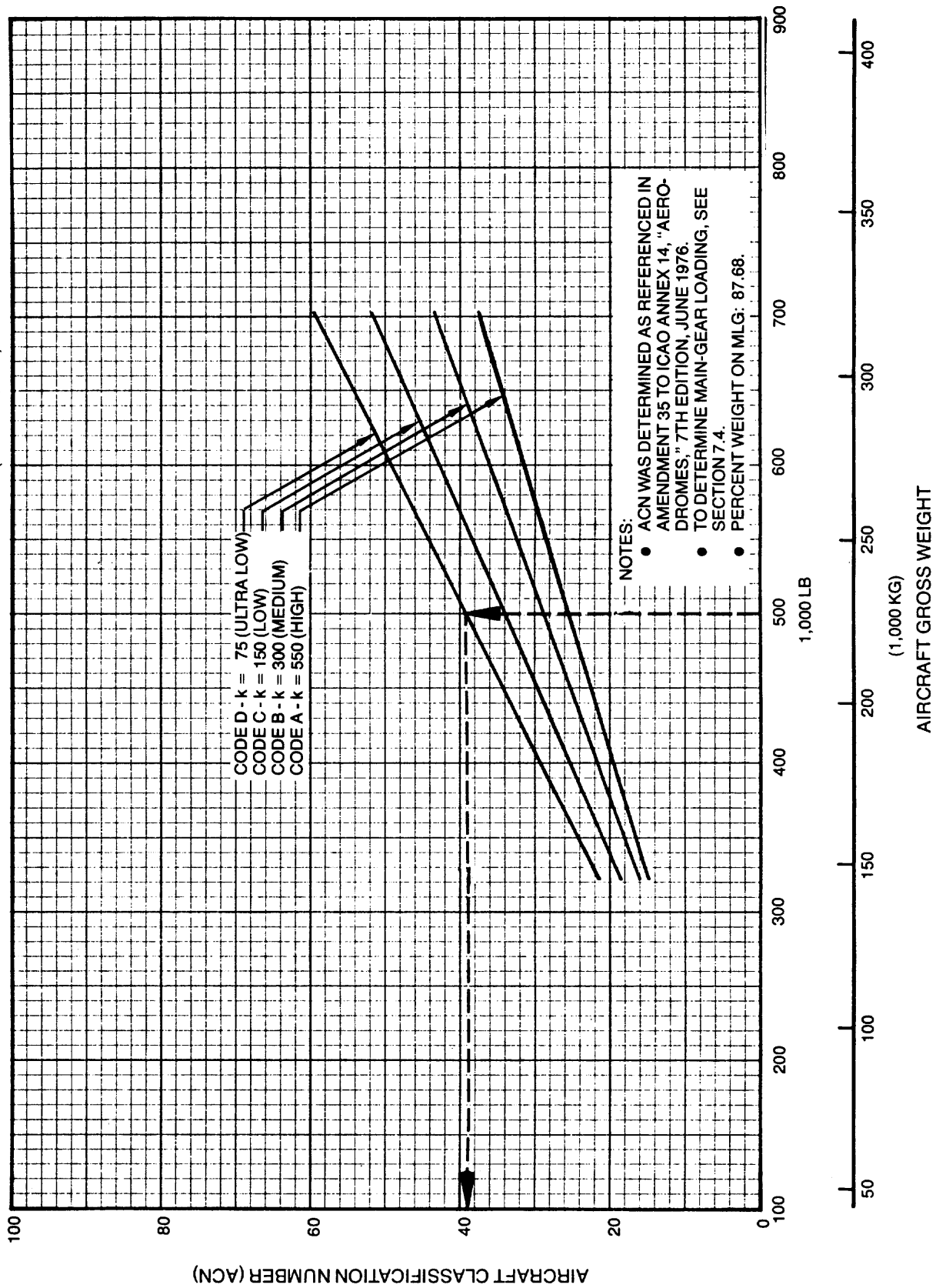

**7.10.4 AIRCRAFT CLASSIFICATION NUMBER - RIGID PAVEMENT
 MODEL 747SP**

7.10.5 Development of ACN Charts

The following ACN charts for flexible and rigid pavements were developed by methods referenced in Amendment 35 to ICAO Annex 14. The procedures used to develop these charts are also described below.

The following procedure is used to develop the flexible-pavement ACN charts:

1. Determine the percentage of weight on the main gear to be used in steps 2, 3, and 4 below. It is the maximum aft center of gravity position that yields the critical loading on the critical gear (see Section 7.4). This center of gravity position is used to determine the main-gear loads at all gross weights of the model being considered.
2. Establish a flexible-pavement requirements chart using the S-77-1 design method, such as shown on the right-hand side of the chart. Use standard subgrade strengths of CBR 3, 6, 10, and 15 and 10,000 coverages. This chart provides the same thickness values as those of section 7.5, but is presented here in a different format.
3. Determine reference thickness values from the pavement requirements chart of step 2 for each standard subgrade strength and gear loading.
4. Enter the reference thickness values into the ACN flexible-pavement conversion chart shown on the left-hand side of the chart to determine ACN. This chart was developed using the S-77-1 design method with a single tire inflated to 180 psi (1.25 MPa) pressure and 10,000 coverages. The ACN is two times the derived single-wheel load expressed in thousands of kilograms. These values of ACN are then plotted as a function of aircraft gross weight, as shown on 7.10.1 and 7.10.2.

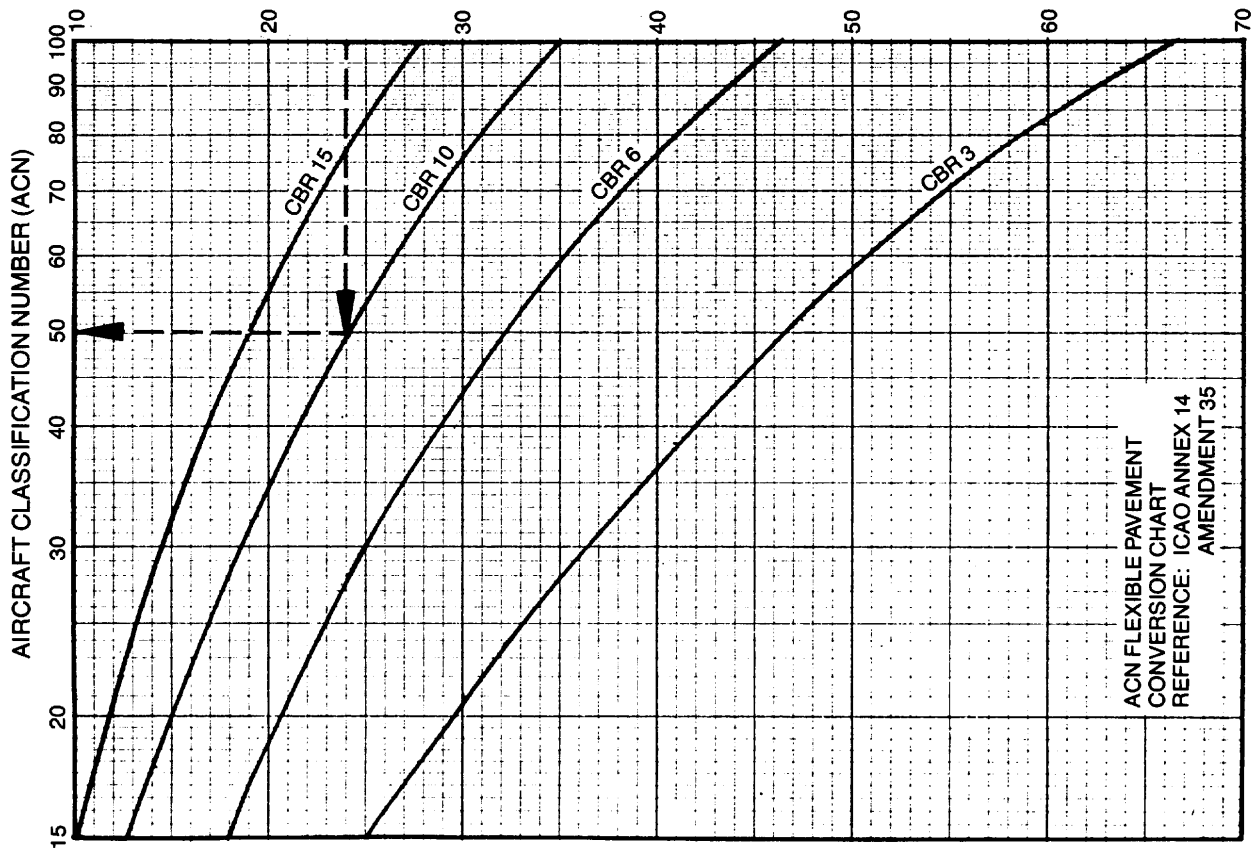
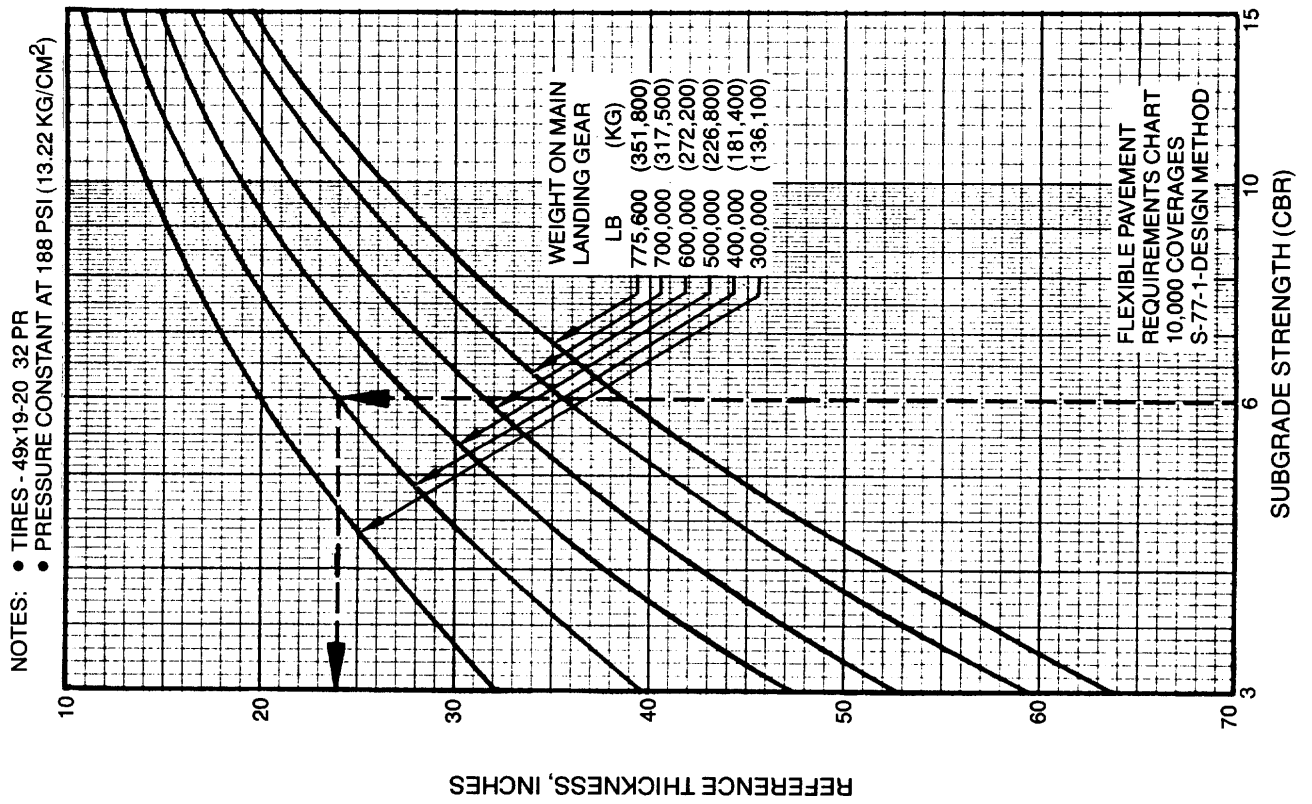

7.10.5 DEVELOPMENT OF AIRCRAFT CLASSIFICATION NUMBER (ACN) - FLEXIBLE PAVEMENT MODELS 747-100, -200, -300

The following procedure is used to develop the rigid-pavement ACN charts:

1. Determine the percentage of weight on the main gear to be used in steps 2, 3 and 4 below. It is the maximum aft center of gravity position that yields the critical loading on the critical gear (see Section 7.4). This center of gravity position used to determine main-gear loads at all gross weights of the model being considered.
2. Establish a rigid-pavement requirements chart using the PCA computer program PDILB, such as shown on the right-hand side of the chart. Use standard subgrade strengths of $k = 75, 150, 300,$ and 550 pci — nominal values for $K=20, 40, 80,$ and 150 MN/m³, respectively. This chart provides the same thickness values of those in Section 7.7.
3. Determine reference thickness values from the pavement requirements chart of step 2 for each standard subgrade strength and gear loading at 400 psi working stress (nominal value for 2.75 MPa working stress).
4. Enter the reference thickness values into the ACN rigid-pavement conversion chart shown on the left-hand side of the chart to determine ACN. This chart was developed using the PCA Computer program PDILB with a single tire inflated to 180 psi (1.25 MPa) pressure and a working stress of 400 psi. The ACN is two times the derived single-wheel load expressed in thousands of kilograms. These values of ACN are then plotted as a function for aircraft gross weight, as shown on 7.10.3 and 7.10.4.

- TIRES — 49x17 30PR; 49x17 32PR; 49x19-20 32PR; 49x19-20 34PR
- PRESSURE RANGE FROM 188 TO 204 PSI (13.2 to 14.4 KG/CM²)

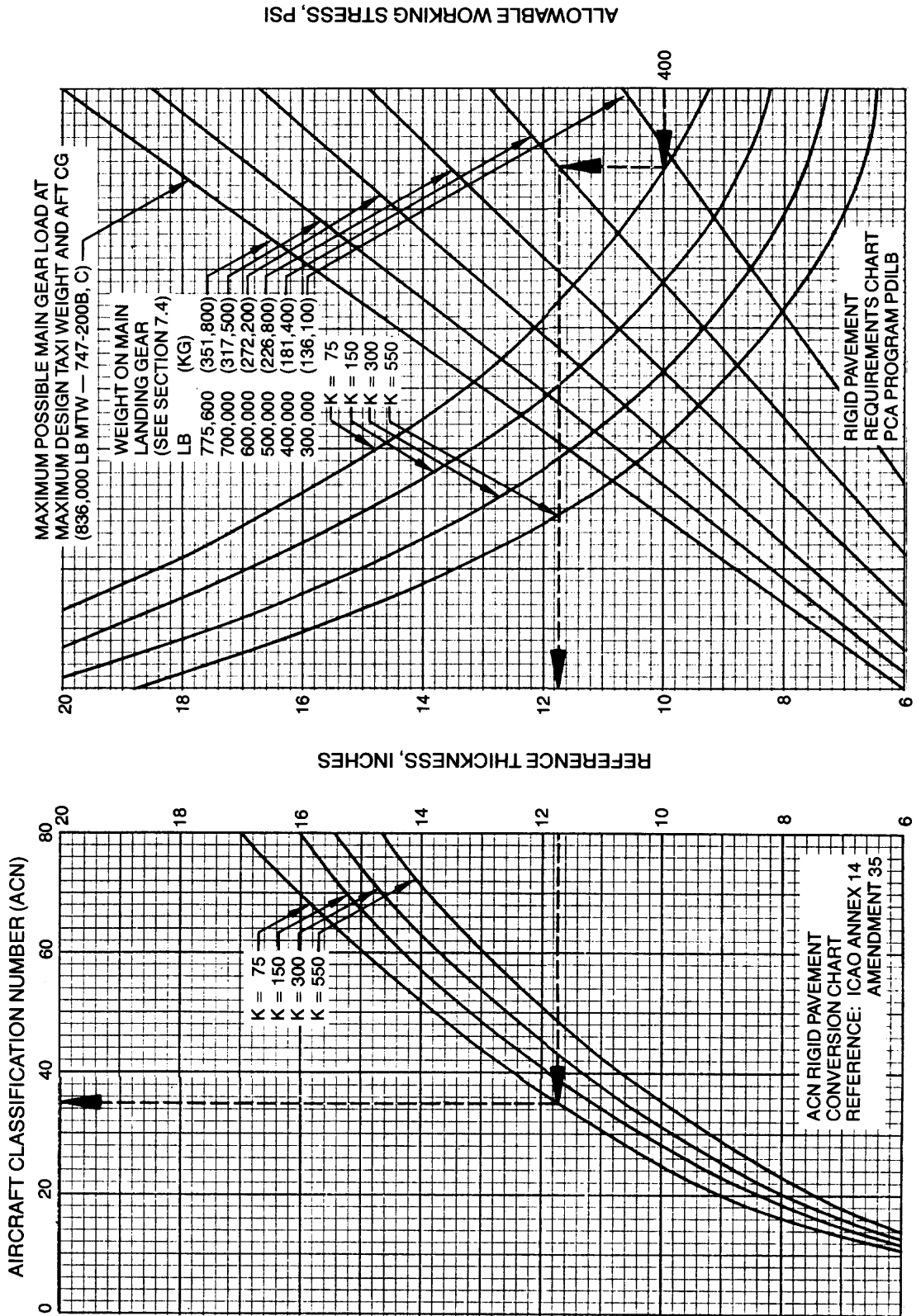

7.10.6 DEVELOPMENT OF AIRCRAFT CLASSIFICATION NUMBER (ACN) — RIGID PAVEMENT MODELS 747-100, -200, -300

THIS PAGE INTENTIONALLY LEFT BLANK

8.0 FUTURE 747 DERIVATIVE AIRPLANES

8.0 FUTURE 747 DERIVATIVE AIRPLANES

Several derivatives are being studied to provide additional capabilities for the 747.

Near term seating capacity growth has been accomplished by the 747-300 with the stretched upper deck. Additional seating capacity could be obtained by conventional body extensions or by upper deck extensions. A 31-foot body stretch with a partial stretched upper deck could provide an increase of 150 passengers over the 747-200. Studies have verified that body length increases up to 50 feet are technically feasible. Landing gear wheel base would be modified accordingly. Full-length extension of the upper deck is an alternate method of increasing seating capacity. This could provide 650 total seats without increasing overall body length. Double deck configurations with moderate body extensions could provide mixed-class seating capacities in excess of 700.

Where current range capability can be traded for increased payloads, existing maximum gross weights will suffice and no wing dimensional changes are necessary. Where range must be maintained with substantial payload increases, gross weights close to 1,000,000 lb are possible with new-generation wings, with a corresponding increase in wingspan of up to 60 ft. As airplane weight and size increase, planned thrust growth of current engines will provide takeoff performance equal to or better than that of current models, and the required pavement thickness can be controlled by changes in landing gear configurations.

The 747SP vertical tail rises 2 ft higher than that of the basic 747. Future growth versions of the 747 could require tail height increases of up to 8 ft, depending on body length, engine size, and more outboard engine placement resulting from the increased wingspan.

The above discussion covers 747 growth “possibilities.” Whether and/or when these or other possibilities are actually built is entirely dependent on future airline requirements. In any event, impact on airport facilities will be a consideration in configuration and design.

- 9.0 **SCALED 747 DRAWINGS**
- 9.1-9.5 **747-100B, -200, -300**
- 9.6-9.10 **747SP**

THIS PAGE INTENTIONALLY LEFT BLANK

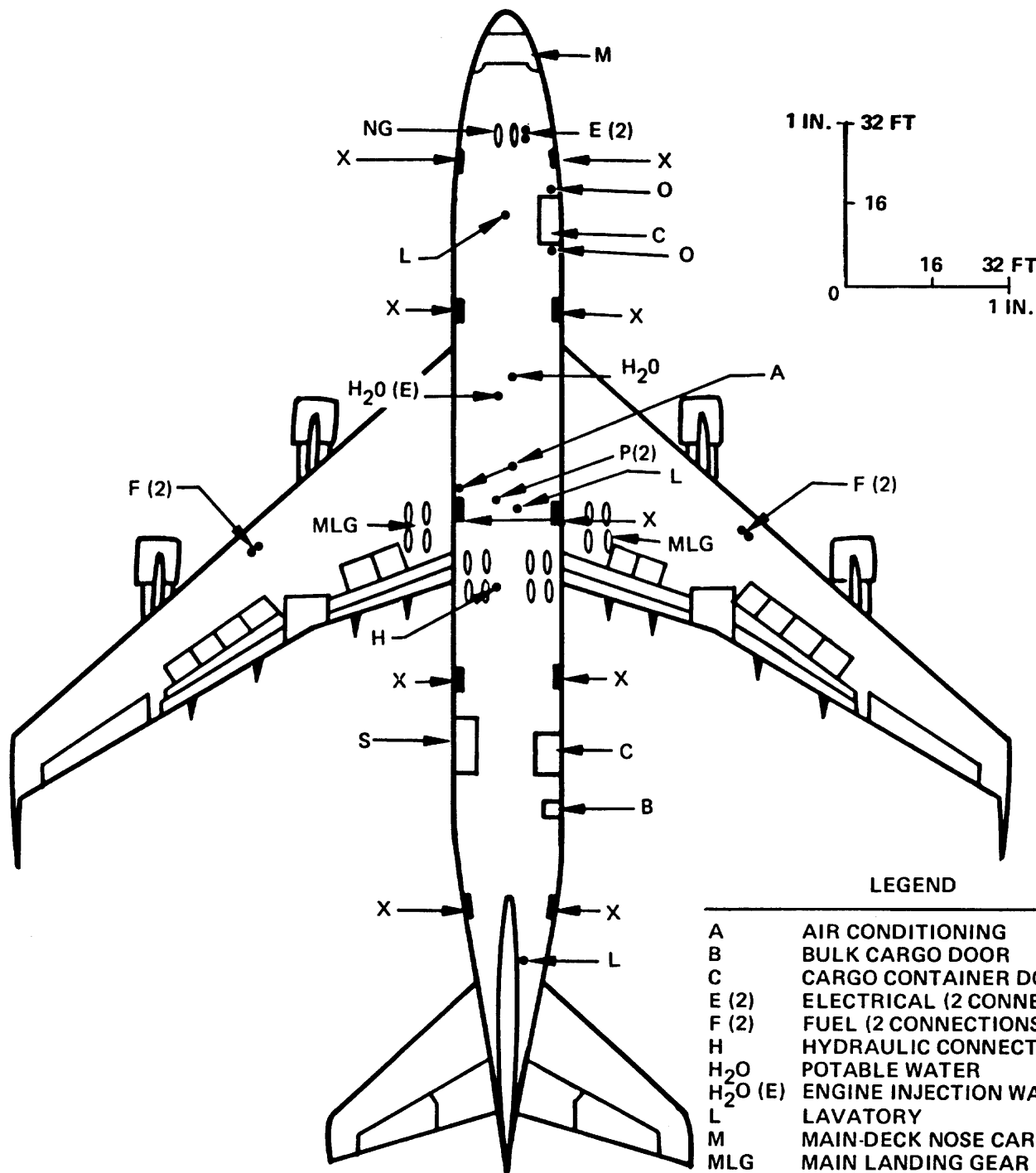

LEGEND

A	AIR CONDITIONING
B	BULK CARGO DOOR
C	CARGO CONTAINER DOOR
E (2)	ELECTRICAL (2 CONNECTIONS)
F (2)	FUEL (2 CONNECTIONS)
H	HYDRAULIC CONNECTION
H ₂ O	POTABLE WATER
H ₂ O (E)	ENGINE INJECTION WATER
L	LAVATORY
M	MAIN-DECK NOSE CARGO DOOR
MLG	MAIN LANDING GEAR
NG	NOSE GEAR
O	OXYGEN
P (2)	PNEUMATIC AIR START (2 CONN.)
S	MAIN-DECK SIDE CARGO DOOR
X	PASSENGER DOOR

- NOTES:**
1. FOR TURNING RADIUS DATA, SEE SEC. 4.2 AND 4.3.
 2. CONSULT USING AIRLINE FOR APPLICABLE SERVICE CONNECTIONS AND OPTIONS.

9.1 SCALED DRAWING - 1 IN. = 32 FT
 MODELS 747-100B, -200, -300

THIS PAGE INTENTIONALLY LEFT BLANK

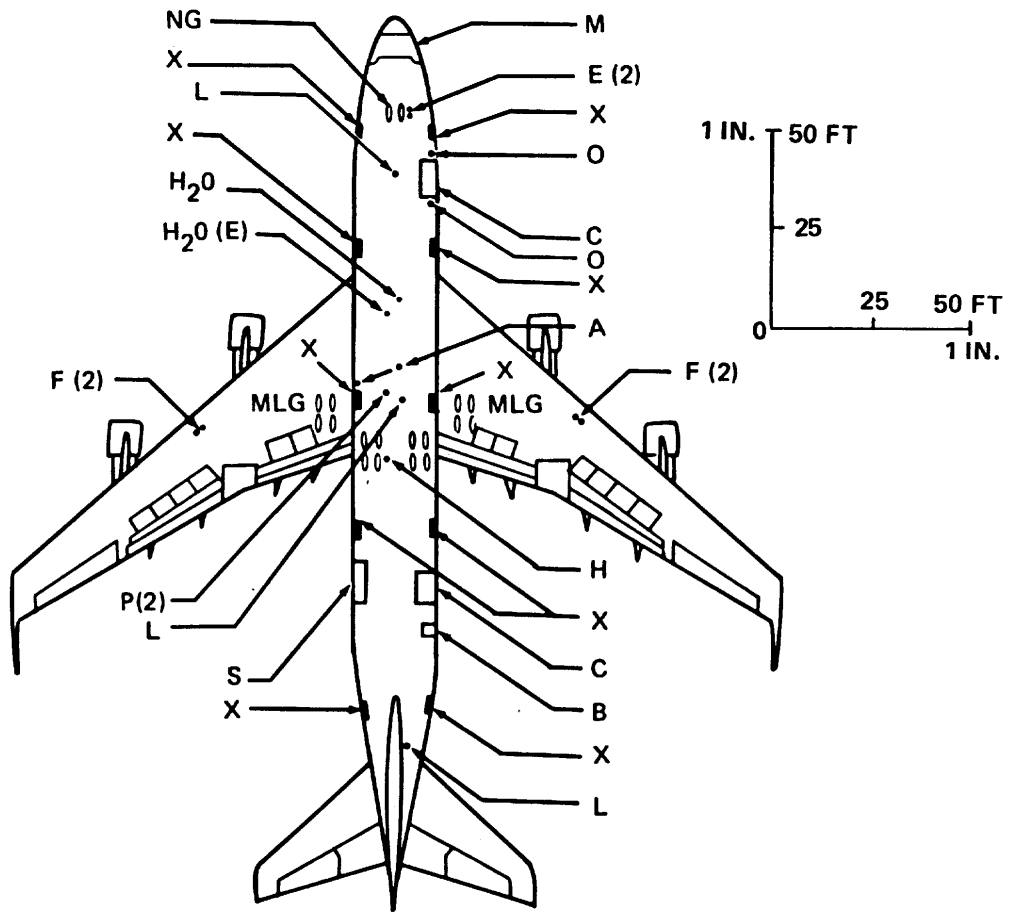

LEGEND

A	AIR CONDITIONING
B	BULK CARGO DOOR
C	CARGO CONTAINER DOOR
E (2)	ELECTRICAL (2 CONNECTIONS)
F (2)	FUEL (2 CONNECTIONS)
H	HYDRAULIC CONNECTION
H ₂ O	POTABLE WATER
H ₂ O (E)	ENGINE INJECTION WATER
L	LAVATORY
M	MAIN-DECK NOSE CARGO DOOR
MLG	MAIN LANDING GEAR
NG	NOSE GEAR
O	OXYGEN
P (2)	PNEUMATIC AIR START (2 CONN.)
S	MAIN-DECK SIDE CARGO DOOR
X	PASSENGER DOOR

- NOTES: 1. FOR TURNING RADIUS DATA, SEE SEC. 4.2 AND 4.3.
 2. CONSULT USING AIRLINE FOR APPLICABLE SERVICE CONNECTIONS AND OPTIONS.

9.2 SCALED DRAWING - 1 IN. = 50 FT
 MODELS 747-100B, -200, -300

THIS PAGE INTENTIONALLY LEFT BLANK

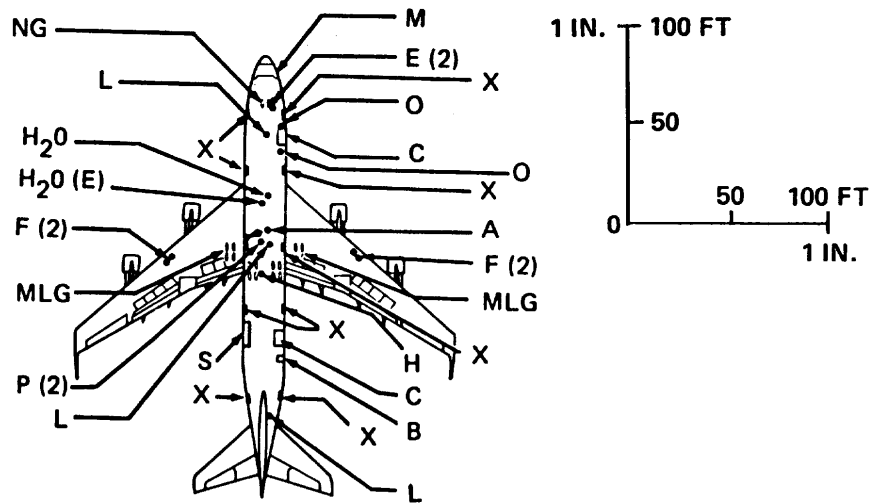

LEGEND

A	AIR CONDITIONING
B	BULK CARGO DOOR
C	CARGO CONTAINER DOOR
E (2)	ELECTRICAL (2 CONNECTIONS)
F (2)	FUEL (2 CONNECTIONS)
H	HYDRAULIC CONNECTION
H ₂ O	POTABLE WATER
H ₂ O (E)	ENGINE INJECTION WATER
L	LAVATORY
M	MAIN-DECK NOSE CARGO DOOR
MLG	MAIN LANDING GEAR
NG	NOSE GEAR
O	OXYGEN
P (2)	PNEUMATIC AIR START (2 CONN.)
S	MAIN-DECK SIDE CARGO DOOR
X	PASSENGER DOOR

- NOTES: 1. FOR TURNING RADIUS DATA, SEE SEC. 4.2 AND 4.3.
 2. CONSULT USING AIRLINE FOR APPLICABLE SERVICE CONNECTIONS AND OPTIONS.

9.3 SCALED DRAWING - 1 IN. = 100 FT
 MODELS 747-100B, -200, -300

D6-58326

MAY 1984

241

THIS PAGE INTENTIONALLY LEFT BLANK

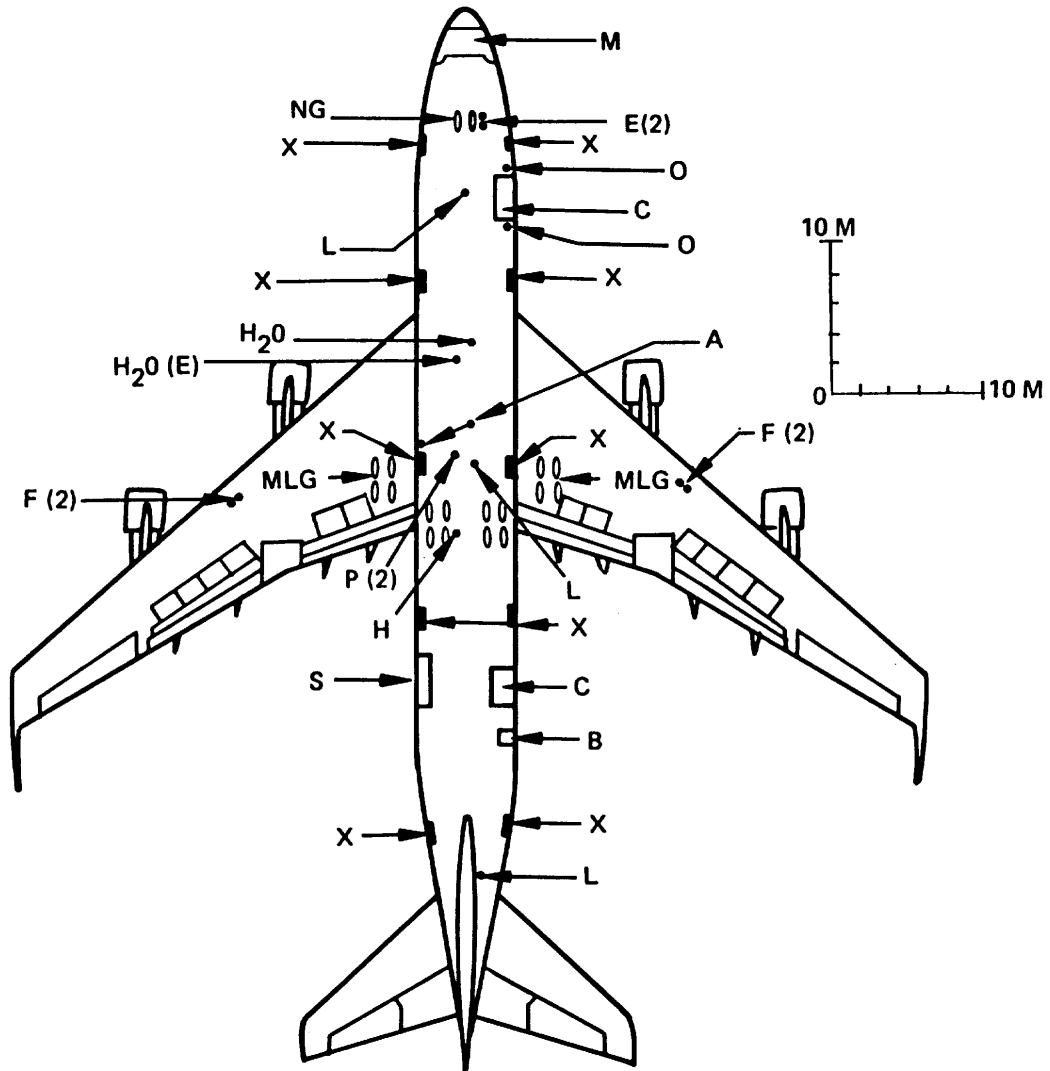

LEGEND

A	AIR CONDITIONING
B	BULK CARGO DOOR
C	CARGO CONTAINER DOOR
E (2)	ELECTRICAL (2 CONNECTIONS)
F (2)	FUEL (2 CONNECTIONS)
H	HYDRAULIC CONNECTION
H ₂ O	POTABLE WATER
H ₂ O (E)	ENGINE INJECTION WATER
L	LAVATORY
M	MAIN-DECK NOSE CARGO DOOR
MLG	MAIN LANDING GEAR
NG	NOSE GEAR
O	OXYGEN
P (2)	PNEUMATIC AIR START (2 CONN.)
S	MAIN-DECK SIDE CARGO DOOR
X	PASSENGER DOOR

- NOTES:**
1. FOR TURNING RADIUS DATA, SEE SEC. 4.2 AND 4.3.
 2. CONSULT USING AIRLINE FOR APPLICABLE SERVICE CONNECTIONS AND OPTIONS.

9.4 SCALED DRAWING - 1:500
 MODELS 747-100B, -200, -300

THIS PAGE INTENTIONALLY LEFT BLANK

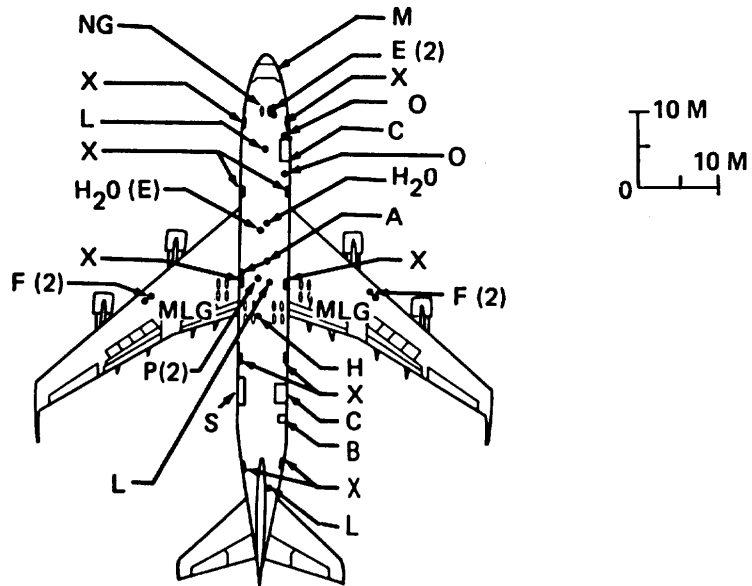

LEGEND

A	AIR CONDITIONING
B	BULK CARGO DOOR
C	CARGO CONTAINER DOOR
E (2)	ELECTRICAL (2 CONNECTIONS)
F (2)	FUEL (2 CONNECTIONS)
H	HYDRAULIC CONNECTION
H ₂ O	POTABLE WATER
H ₂ O (E)	ENGINE INJECTION WATER
L	LAVATORY
M	MAIN-DECK NOSE CARGO DOOR
MLG	MAIN LANDING GEAR
NG	NOSE GEAR
O	OXYGEN
P (2)	PNEUMATIC AIR START (2 CONN.)
S	MAIN-DECK SIDE CARGO DOOR
X	PASSENGER DOOR

- NOTES: 1. FOR TURNING RADIUS DATA, SEE SEC. 4.2 AND 4.3.
 2. CONSULT USING AIRLINE FOR APPLICABLE SERVICE CONNECTIONS AND OPTIONS.

9.5 SCALED DRAWING - 1:1,000
 MODELS 747-100B, -200, -300

D6-58326

MAY 1984

245

THIS PAGE INTENTIONALLY LEFT BLANK

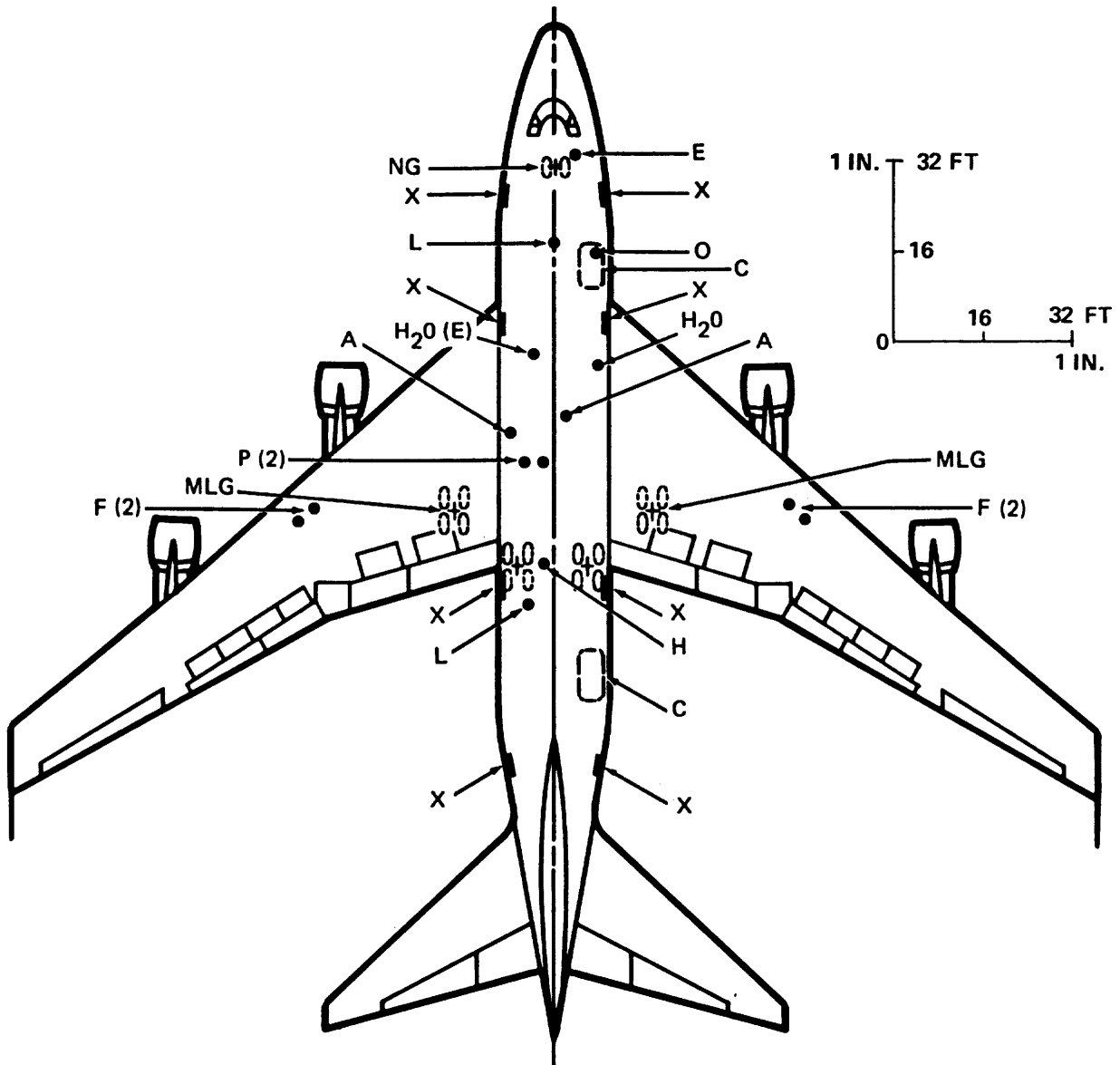

LEGEND

A	AIR CONDITIONING
C	CARGO CONTAINER DOOR
E	ELECTRICAL
F (2)	FUEL (2 CONNECTIONS)
H	HYDRAULIC CONNECTION
H ₂ O	POTABLE WATER
H ₂ O (E)	ENGINE INJECTION WATER
L	LAVATORY
MLG	MAIN LANDING GEAR
NG	NOSE GEAR
O	OXYGEN
P (2)	PNEUMATIC AIR START (2 CONN.)
X	PASSENGER DOOR

NOTE: FOR TURNING RADIUS DATA, SEE SEC. 4.2 AND 4.3

9.6 SCALED DRAWING - 1 IN. = 32 FT
MODEL 747SP

THIS PAGE INTENTIONALLY LEFT BLANK

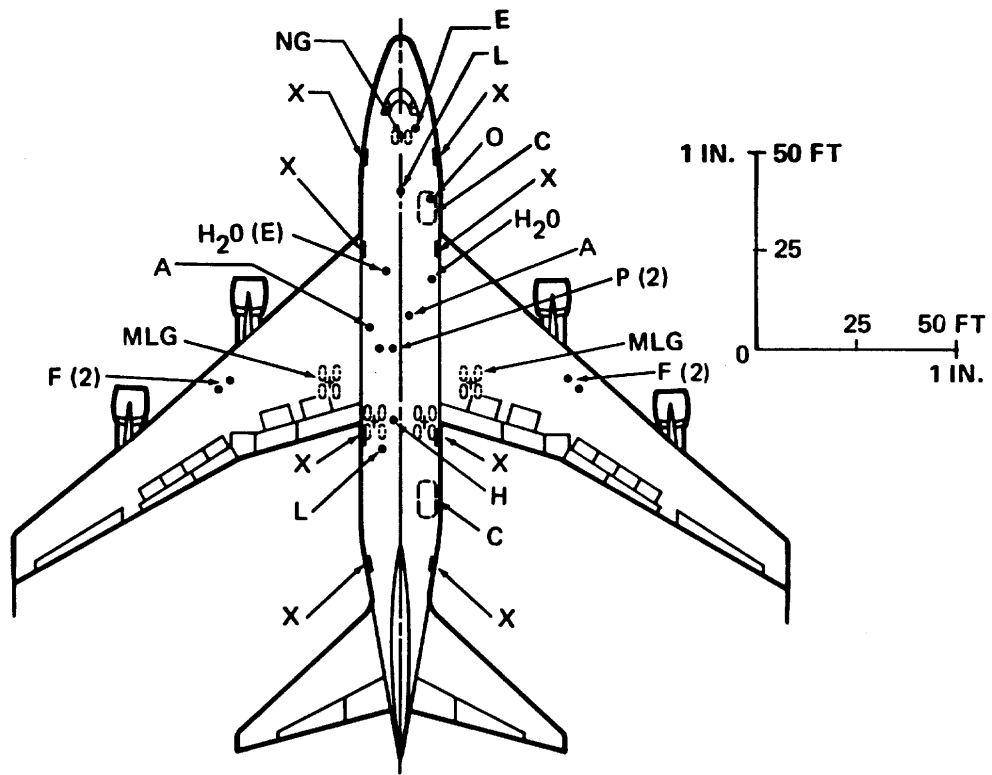

LEGEND

A	AIR CONDITIONING
C	CARGO CONTAINER DOOR
E	ELECTRICAL
F (2)	FUEL (2 CONNECTIONS)
H	HYDRAULIC CONNECTION
H ₂ O	POTABLE WATER
H ₂ O (E)	ENGINE INJECTION WATER
L	LAVATORY
MLG	MAIN LANDING GEAR
NG	NOSE GEAR
O	OXYGEN
P (2)	PNEUMATIC AIR START (2 CONN.)
X	PASSENGER DOOR

NOTE: FOR TURNING RADIUS DATA,
SEE SEC. 4.2 AND 4.3

9.7 SCALED DRAWING - 1 IN. = 50 FT
MODEL 747SP

THIS PAGE INTENTIONALLY LEFT BLANK

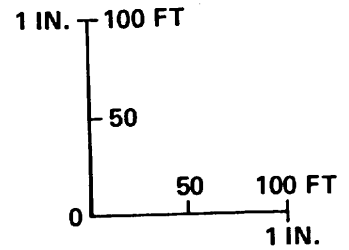
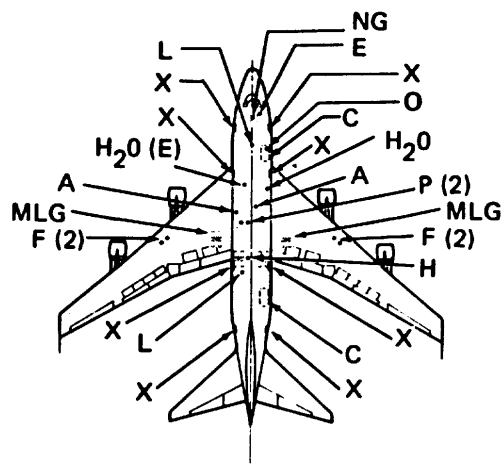

LEGEND

A	AIR CONDITIONING
C	CARGO CONTAINER DOOR
E	ELECTRICAL
F (2)	FUEL (2 CONNECTIONS)
H	HYDRAULIC CONNECTION
H ₂ O	POTABLE WATER
H ₂ O (E)	ENGINE INJECTION WATER
L	LAVATORY
MLG	MAIN LANDING GEAR
NG	NOSE GEAR
O	OXYGEN
P (2)	PNEUMATIC AIR START (2 CONN.)
X	PASSENGER DOOR

NOTE: FOR TURNING RADIUS DATA,
SEE SEC. 4.2 AND 4.3

9.8 SCALED DRAWING - 1 IN. = 100 FT MODEL 747SP

THIS PAGE INTENTIONALLY LEFT BLANK

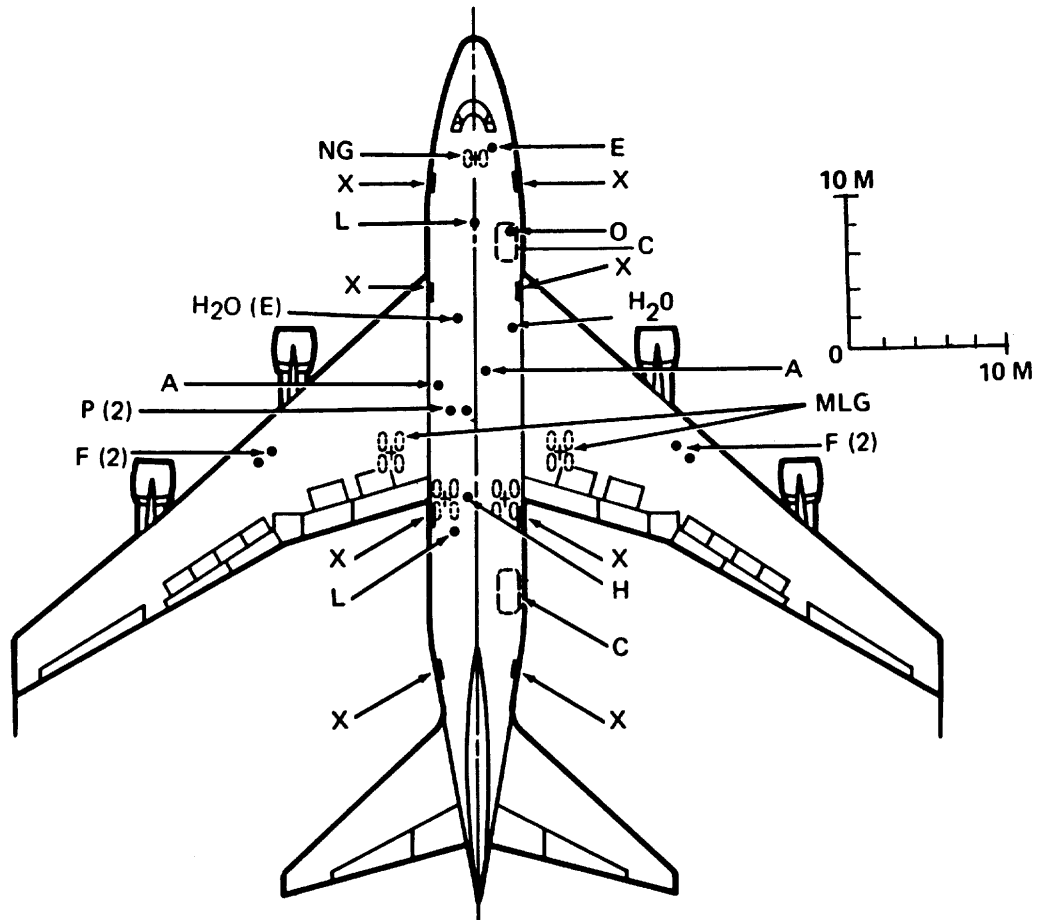

LEGEND

A	AIR CONDITIONING
C	CARGO CONTAINER DOOR
E	ELECTRICAL
F (2)	FUEL (2 CONNECTIONS)
H	HYDRAULIC CONNECTION
H ₂ O	POTABLE WATER
H ₂ O (E)	ENGINE INJECTION WATER
L	LAVATORY
MLG	MAIN LANDING GEAR
NG	NOSE GEAR
O	OXYGEN
P (2)	PNEUMATIC AIR START (2 CONN.)
X	PASSENGER DOOR

NOTE: FOR TURNING RADIUS DATA,
SEE SEC. 4.2 AND 4.3

9.9 SCALED DRAWING - 1:500
MODEL 747SP

THIS PAGE INTENTIONALLY LEFT BLANK

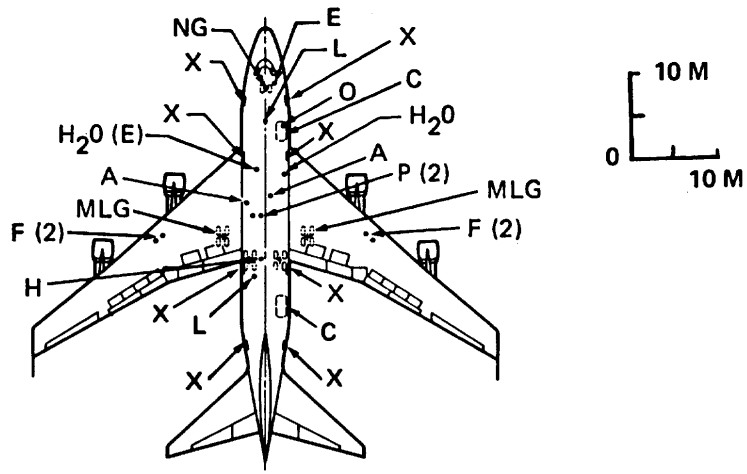

LEGEND

A	AIR CONDITIONING
C	CARGO CONTAINER DOOR
E	ELECTRICAL
F (2)	FUEL (2 CONNECTIONS)
H	HYDRAULIC CONNECTION
H ₂ O	POTABLE WATER
H ₂ O (E)	ENGINE INJECTION WATER
L	LAVATORY
MLG	MAIN LANDING GEAR
NG	NOSE GEAR
O	OXYGEN
P (2)	PNEUMATIC AIR START (2 CONN.)
X	PASSENGER DOOR
NOTE:	FOR TURNING RADIUS DATA, SEE SEC 4.2 AND 4.3

9.10 SCALED DRAWING - 1:1,000
MODEL 747SP

D6-58326

APRIL 1981

255

THIS PAGE INTENTIONALLY LEFT BLANK