



CAGE Code 81205

737 MAX Airplane Characteristics for Airport Planning

DOCUMENT NUMBER:
D6-38A004

REVISION:
REV C

REVISION DATE:
November 2018

CONTENT OWNER:

Boeing Commercial Airplanes

All revisions to this document must be approved by the content owner before release.



Revision Record

Revision Letter	C
Revision Date	June 2018
Changes in This Revision	BBJ MAX 8: Updated Release All sections
Revision Letter	B
Revision Date	June 2018
Changes in This Revision	737-7: Initial Release 737-9: Updated Release All sections
Revision Letter	A
Revision Date	August 2017
Changes in This Revision	737-8-200 / -9 / BBJ MAX 8: Initial Release 737-8: Updated Release All sections
Revision Letter	New
Revision Date	July 2015
Changes in This Revision	Initial release of 737-8 data. All sections

Table of Contents

1.0	SCOPE AND INTRODUCTION	1-1
1.1	SCOPE	1-1
1.2	INTRODUCTION	1-2
1.3	BRIEF DESCRIPTION OF THE 737 MAX FAMILY OF AIRPLANES	1-3
1.4	CONVERSION FACTORS	1-4
2.0	AIRPLANE DESCRIPTION	2-5
2.1	GENERAL CHARACTERISTICS	2-5
2.1.1	General Characteristics: Model 737-7	2-6
2.1.2	General Characteristics: Model 737-8 / -8-200	2-7
2.1.3	General Characteristics: Model BBJ MAX 8	2-8
2.1.4	General Characteristics: Model 737-9	2-9
2.2	GENERAL DIMENSIONS	2-10
2.2.1	General Dimensions: Model 737-7	2-10
2.2.2	General Dimensions: Model 737-8 / -8-200 / BBJ MAX 8	2-11
2.2.3	General Dimensions: Model 737-9	2-12
2.3	GROUND CLEARANCES	2-13
2.3.1	Ground Clearances: Model 737-7	2-13
2.3.2	Ground Clearances: Model 737-8 / -8-200 / BBJ MAX 8	2-14
2.3.3	Ground Clearances: Model 737-9	2-15
2.4	INTERIOR ARRANGEMENTS	2-16
2.4.1	Interior Arrangements: Model 737-7	2-16
2.4.2	Interior Arrangements: Model 737-8	2-17
2.4.3	Interior Arrangements: Model 737-8-200	2-18
2.4.4	Interior Arrangements: Model 737-9	2-19
2.5	CABIN CROSS SECTIONS	2-20
2.5.1	Cabin Cross-Sections: All Models	2-20
2.6	LOWER CARGO COMPARTMENTS	2-21
2.6.1	Lower Cargo Compartments: All Models	2-21
2.6.2	Lower Cargo Compartments: Model BBJ MAX 8	2-22
2.7	DOOR CLEARANCES	2-23
2.7.1	Passenger and Cargo Door Locations: All Models	2-23
2.7.2	Door Clearances - Forward Main Entry Door: All Models	2-24
2.7.3	Door Clearances - Optional Forward Airstairs, Forward Main Entry Door: All Models	2-25
2.7.4	Door Clearances: Sensor and Probe Locations - Forward Cabin Doors: All Models	2-26
2.7.5	Door Clearances – Forward Service Door: All Models	2-27
2.7.6	Door Clearances - Aft Entry/Service Door: All Models	2-28

2.7.7	Door Clearances - Lower Deck Cargo Compartments: All Models	2-29
3.0	AIRPLANE PERFORMANCE	3-30
3.1	GENERAL INFORMATION.....	3-30
3.2	PAYLOAD/RANGE FOR LONG RANGE CRUISE	3-31
3.2.1	Payload/Range for Long Range Cruise: Model 737-7 / -8-200	3-31
3.2.2	Payload/Range for Long Range Cruise: Model 737-8.....	3-32
3.2.3	Payload/Range for Long Range Cruise: Model BBJ MAX 8.....	3-33
3.2.4	Payload/Range for Long Range Cruise: Model 737-9.....	3-34
3.3	FAA/EASA TAKEOFF RUNWAY LENGTH REQUIREMENTS	3-35
3.3.1	FAA/EASA Takeoff Runway Length Requirements: Model 737-7 / -8-200	3-35
3.3.2	FAA/EASA Takeoff Runway Length Requirements - Standard Day, Dry Runway: Model 737-8 (LEAP-1B25 Engine).....	3-36
3.3.3	FAA/EASA Takeoff Runway Length Requirements - Standard Day + 27°F (STD + 15°C), Dry Runway: Model 737-8 (LEAP-1B25 Engine)	3-37
3.3.4	FAA/EASA Takeoff Runway Length Requirements - Standard Day + 45°F (STD + 25°C), Dry Runway: Model 737-8 (LEAP-1B25 Engine)	3-38
3.3.5	FAA/EASA Takeoff Runway Length Requirements - Standard Day + 63°F (STD + 35 °C), Dry Runway: Model 737-8 (LEAP-1B25 Engine)	3-39
3.3.6	FAA/EASA Takeoff Runway Length Requirements - Standard Day, Dry Runway: Model 737-8 / BBJ MAX 8 (LEAP-1B28B1 / -1B28BBJ1 Engines).....	3-40
3.3.7	FAA/EASA Takeoff Runway Length Requirements - Standard Day + 27°F (STD + 15°C), Dry Runway: Model 737-8 / BBJ MAX 8 (LEAP-1B28B1 / -1B28BBJ1 Engines)	3-41
3.3.8	FAA/EASA Takeoff Runway Length Requirements - Standard Day + 45°F (STD + 25°C), Dry Runway: Model 737-8 / BBJ MAX 8 (LEAP-1B28B1 / -1B28BBJ1 Engines)	3-42
3.3.9	FAA/EASA Takeoff Runway Length Requirements - Standard Day + 63°F (STD + 35 °C), Dry Runway: Model 737-8 / BBJ MAX 8 (LEAP-1B28B1 / -1B28BBJ1 Engines)	3-43
3.3.10	FAA/EASA Takeoff Runway Length Requirements - Standard Day, Dry Runway: Model 737-9 (LEAP-1B27 Engine).....	3-44
3.3.11	FAA/EASA Takeoff Runway Length Requirements - Standard Day + 27°F (STD + 15°C), Dry Runway: Model 737-9 (LEAP-1B27 Engine)	3-45
3.3.12	FAA/EASA Takeoff Runway Length Requirements - Standard Day + 45°F (STD + 25°C), Dry Runway: Model 737-9 (LEAP-1B27 Engine)	3-46

3.3.13	FAA/EASA Takeoff Runway Length Requirements - Standard Day + 63°F (STD + 35 °C), Dry Runway: Model 737-9 (LEAP-1B27 Engine)	3-47
3.3.14	FAA/EASA Takeoff Runway Length Requirements - Standard Day, Dry Runway: Model 737-9 (LEAP-1B28 Engine).....	3-48
3.3.15	FAA/EASA Takeoff Runway Length Requirements - Standard Day + 27°F (STD + 15°C), Dry Runway: Model 737-9 (LEAP-1B28 Engine)	3-49
3.3.16	FAA/EASA Takeoff Runway Length Requirements - Standard Day + 45°F (STD + 25°C), Dry Runway: Model 737-9 (LEAP-1B28 Engine)	3-50
3.3.17	FAA/EASA Takeoff Runway Length Requirements - Standard Day + 63°F (STD + 35 °C), Dry Runway: Model 737-9 (LEAP-1B28 Engine)	3-51
3.4	FAA/EASA LANDING RUNWAY LENGTH REQUIREMENTS.....	3-52
3.4.1	FAA/EASA Landing Runway Length Requirements: Model 737-7 / -8-200	3-52
3.4.2	FAA/EASA Landing Runway Length Requirements - Flaps 15: Model 737-8 / BBJ MAX 8.....	3-53
3.4.3	FAA/EASA Landing Runway Length Requirements - Flaps 30: Model 737-8 / BBJ MAX 8.....	3-54
3.4.4	FAA/EASA Landing Runway Length Requirements - Flaps 40: Model 737-8 / BBJ MAX 8.....	3-55
3.4.5	FAA/EASA Landing Runway Length Requirements - Flaps 15: Model 737-9.....	3-56
3.4.6	FAA/EASA Landing Runway Length Requirements - Flaps 30: Model 737-9.....	3-57
3.4.7	FAA/EASA Landing Runway Length Requirements - Flaps 40: Model 737-9.....	3-58
4.0	GROUND MANEUVERING	4-59
4.1	GENERAL INFORMATION.....	4-59
4.2	TURNING RADII	4-60
4.2.1	Turning Radii – No Slip Angle: Model 737-7	4-60
4.2.2	Turning Radii – No Slip Angle: Model 737-8 / -8-200 / BBJ MAX 8	4-61
4.2.3	Turning Radii – No Slip Angle: Model 737-9	4-62
4.3	CLEARANCE RADII	4-63
4.3.1	Clearance Radii – 3° and 5° Slip Angles: All Models	4-63
4.4	VISIBILITY FROM COCKPIT IN STATIC POSITION: ALL MODELS	4-64
4.5	RUNWAY AND TAXIWAY TURNPATHS	4-65
4.5.1	Runway and Taxiway Turnpaths - Runway-to-Taxiway, More Than 90-Degree Turn: Model 737-7	4-65

4.5.2	Runway and Taxiway Turnpaths - Runway-to-Taxiway, 90-Degree Turn: Model 737-7.....	4-66
4.5.3	Runway and Taxiway Turnpaths - Taxiway-to-Taxiway, 90-Degree Turn: Model 737-7.....	4-67
4.5.4	Runway and Taxiway Turnpaths - Runway-to-Taxiway, More Than 90-Degree Turn: Model 737-8 / -8-200 / BBJ MAX 8.....	4-68
4.5.5	Runway and Taxiway Turnpaths - Runway-to-Taxiway, 90-Degree Turn: Model 737-8 / -8-200 / BBJ MAX 8.....	4-69
4.5.6	Runway and Taxiway Turnpaths - Taxiway-to-Taxiway, 90-Degree Turn: Model 737-8 / -8-200 / BBJ MAX 8.....	4-70
4.5.7	Runway and Taxiway Turnpaths - Runway-to-Taxiway, More Than 90-Degree Turn: Model 737-9.....	4-71
4.5.8	Runway and Taxiway Turnpaths - Runway-to-Taxiway, 90-Degree Turn: Model 737-9.....	4-72
4.5.9	Runway and Taxiway Turnpaths - Taxiway-to-Taxiway, 90-Degree Turn: Model 737-9.....	4-73
4.6	RUNWAY HOLDING BAY: MODEL 737, ALL MODELS.....	4-74
5.0	TERMINAL SERVICING.....	5-75
5.1	AIRPLANE SERVICING ARRANGEMENT - TYPICAL TURNAROUND.....	5-76
5.1.1	Airplane Servicing Arrangement - Typical Turnaround: Model 737-7.....	5-76
5.1.2	Airplane Servicing Arrangement - Typical Turnaround: Model 737-8 / -8-200 / BBJ MAX 8.....	5-77
5.1.3	Airplane Servicing Arrangement - Typical Turnaround: Model 737-9.....	5-78
5.1.4	Airplane Servicing Arrangement - Typical En Route: All Models.....	5-79
5.2	TERMINAL OPERATIONS - TURNAROUND STATION.....	5-80
5.2.1	Terminal Operations – Turnaround Station: Model 737-7.....	5-80
5.2.2	Terminal Operations – Turnaround Station: Model 737-8.....	5-81
5.2.3	Terminal Operations – Turnaround Station: Model 737-8-200.....	5-82
5.2.4	Terminal Operations – Turnaround Station: Model 737-9.....	5-83
5.3	TERMINAL OPERATIONS - EN ROUTE STATION.....	5-84
5.3.1	Terminal Operations - En Route Station: Model 737-7.....	5-84
5.3.2	Terminal Operations - En Route Station: Model 737-8.....	5-85
5.3.3	Terminal Operations - En Route Station: Model 737-8-200.....	5-86
5.3.4	Terminal Operations - En Route Station: Model 737-9.....	5-87
5.4	GROUND SERVICING CONNECTIONS.....	5-88
5.4.1	Ground Service Connections - Locations: Model 737-7.....	5-88
5.4.2	Ground Service Connections - Locations: Model 737-8 / -8-200 / BBJ MAX 8.....	5-89
5.4.3	Ground Service Connections - Locations: Model 737-9.....	5-90

5.4.4	Ground Servicing Connections and Capacities: All Models.....	5-91
5.5	ENGINE STARTING PNEUMATIC REQUIREMENTS	5-92
5.5.1	Engine Start Pneumatic Requirements - Sea Level: All Models	5-92
5.6	GROUND PNEUMATIC POWER REQUIREMENTS	5-93
5.6.1	Ground Pneumatic Power Requirements - Heating/Cooling: All Models.....	5-93
5.7	CONDITIONED AIR REQUIREMENTS	5-94
5.7.1	Conditioned Air Flow Requirements: All Models.....	5-94
5.8	GROUND TOWING REQUIREMENTS	5-95
5.8.1	Ground Towing Requirements - English Units: All Models	5-95
5.8.2	Ground Towing Requirements - Metric Units: All Models.....	5-96
6.0	JET ENGINE WAKE AND NOISE DATA	6-1
6.1	JET ENGINE EXHAUST VELOCITIES AND TEMPERATURES	6-1
6.1.1	Jet Engine Exhaust Velocity Contours - Idle Thrust: Model 737-7.....	6-2
6.1.2	Jet Engine Exhaust Velocity Contours - Breakaway Thrust / 0% Slope / Both Engines / MTW: Model 737-7	6-3
6.1.3	Jet Engine Exhaust Velocity Contours - Breakaway Thrust / 1% Slope / Both Engines / MTW: Model 737-7	6-4
6.1.4	Jet Engine Exhaust Velocity Contours - Breakaway Thrust / 0% Slope / Single Engine / MTW: Model 737-7	6-5
6.1.5	Jet Engine Exhaust Velocity Contours - Breakaway Thrust / 0% Slope / Single Engine / MLW: Model 737-7	6-6
6.1.6	Jet Engine Exhaust Velocity Contours - Takeoff Thrust: Model 737-7	6-7
6.1.7	Jet Engine Exhaust Temperature Contours – Idle/Breakaway Thrust: Model 737-7	6-8
6.1.8	Jet Engine Exhaust Temperature Contours – Takeoff Thrust: Model 737-7	6-9
6.1.9	Jet Engine Exhaust Velocity Contours - Idle Thrust: Model 737-8 / -8-200 / BBJ MAX 8.....	6-10
6.1.10	Jet Engine Exhaust Velocity Contours - Breakaway Thrust / 0% Slope / Both Engines / MTW: Model 737-8 / -8-200 / BBJ MAX 8.....	6-11
6.1.11	Jet Engine Exhaust Velocity Contours - Breakaway Thrust / 1% Slope / Both Engines / MTW: Model 737-8 / -8-200 / BBJ MAX 8.....	6-12
6.1.12	Jet Engine Exhaust Velocity Contours - Breakaway Thrust / 0% Slope / Single Engine / MTW: Model 737-8 / -8-200 / BBJ MAX 8.....	6-13
6.1.13	Jet Engine Exhaust Velocity Contours - Breakaway Thrust / 0% Slope / Single Engine / MLW: Model 737-8 / -8-200 / BBJ MAX 8.....	6-14

6.1.14	Jet Engine Exhaust Velocity Contours - Takeoff Thrust: Model 737-8 / -8-200 / BBJ MAX 8	6-15
6.1.15	Jet Engine Exhaust Temperature Contours – Idle/Breakaway Thrust: Model 737-8 / -8-200 / BBJ MAX 8	6-16
6.1.16	Jet Engine Exhaust Temperature Contours – Takeoff Thrust: Model 737-8 / -8-200 / BBJ MAX 8	6-17
6.1.17	Jet Engine Exhaust Velocity Contours - Idle Thrust: Model 737-9.....	6-18
6.1.18	Jet Engine Exhaust Velocity Contours - Breakaway Thrust / 0% Slope / Both Engines / MTW: Model 737-9	6-19
6.1.19	Jet Engine Exhaust Velocity Contours - Breakaway Thrust / 1% Slope / Both Engines / MTW: Model 737-9	6-20
6.1.20	Jet Engine Exhaust Velocity Contours - Breakaway Thrust / 0% Slope / Single Engine / MTW: Model 737-9	6-21
6.1.21	Jet Engine Exhaust Velocity Contours - Breakaway Thrust / 0% Slope / Single Engine / MLW: Model 737-9	6-22
6.1.22	Jet Engine Exhaust Velocity Contours - Takeoff Thrust: Model 737-9	6-23
6.1.23	Jet Engine Exhaust Temperature Contours – Idle/Breakaway Thrust: Model 737-9	6-24
6.1.24	Jet Engine Exhaust Temperature Contours – Takeoff Thrust: Model 737-9.....	6-25
6.2	AIRPORT AND COMMUNITY NOISE.....	6-26
7.0	PAVEMENT DATA	7-1
7.1	GENERAL INFORMATION.....	7-1
7.2	LANDING GEAR FOOTPRINT	7-3
7.2.1	Landing Gear Footprint: All Models.....	7-3
7.3	MAXIMUM PAVEMENT LOADS.....	7-4
7.3.1	Maximum Pavement Loads: All Models	7-4
7.4	LANDING GEAR LOADING ON PAVEMENT	7-5
7.4.1	Landing Gear Loading on Pavement: Model 737-7.....	7-5
7.4.2	Landing Gear Loading on Pavement: Model 737-8 / -8-200 / BBJ MAX 8	7-6
7.4.3	Landing Gear Loading on Pavement: Model 737-9.....	7-7
7.5	FLEXIBLE PAVEMENT REQUIREMENTS - FAA DESIGN METHOD	7-8
7.6	FLEXIBLE PAVEMENT REQUIREMENTS - LCN CONVERSION.....	7-9
7.7	RIGID PAVEMENT REQUIREMENTS - PORTLAND CEMENT ASSOCIATION DESIGN METHOD	7-10
7.8	RIGID PAVEMENT REQUIREMENTS - LCN CONVERSION	7-11
7.9	RIGID PAVEMENT REQUIREMENTS - FAA DESIGN METHOD	7-12
7.10	ACN/PCN REPORTING SYSTEM - FLEXIBLE AND RIGID PAVEMENTS	7-13

7.10.1	Aircraft Classification Number - Flexible Pavement: Model 737-7	7-14
7.10.2	Aircraft Classification Number - Rigid Pavement: Model 737-7	7-15
7.10.3	Aircraft Classification Number - Flexible Pavement: Model 737-8 / -8-200 / BBJ MAX 8.....	7-16
7.10.4	Aircraft Classification Number - Rigid Pavement: Model 737-8 / - 8-200 / BBJ MAX 8	7-17
7.10.5	Aircraft Classification Number - Flexible Pavement: Model 737-9	7-1
7.10.6	Aircraft Classification Number - Rigid Pavement: Model 737-9	7-2
8.0	FUTURE 737 DERIVATIVE AIRPLANES.....	8-3
9.0	SCALED 737 DRAWINGS	9-4
9.1	MODEL 737-7	9-5
9.1.1	Scaled Drawings – 1:500: Model 737-7.....	9-5
9.2	MODEL 737-8.....	9-6
9.2.1	Scaled Drawings – 1:500: Model 737-8.....	9-6
9.3	MODEL 737-9.....	9-7
9.3.1	Scaled Drawings – 1:500: Model 737-9.....	9-7

1.0 SCOPE AND INTRODUCTION

1.1 SCOPE

This document provides, in a standardized format, airplane characteristics data for general airport planning. Since operational practices vary among airlines, specific data should be coordinated with the using airlines prior to facility design. Boeing Commercial Airplanes should be contacted for any additional information required.

Content of the document reflects the results of a coordinated effort by representatives from the following organizations:

- Aerospace Industries Association
- Airports Council International - North America
- Air Transport Association of America
- International Air Transport Association

The airport planner may also want to consider the information presented in the "Commercial Aircraft Design Characteristics - Trends and Growth Projections," for long range planning needs and can be accessed via the following website:

<http://www.boeing.com/airports>

The document is updated periodically and represents the coordinated efforts of the following organizations regarding future aircraft growth trends.

- International Coordinating Council of Aerospace Industries Associations
- Airports Council International - North America
- Air Transport Association of America
- International Air Transport Association

1.2 INTRODUCTION

This document conforms to NAS 3601. It provides characteristics of the Boeing Model 737 MAX airplane for airport planners and operators, airlines, architectural and engineering consultant organizations, and other interested industry agencies. Airplane changes and available options may alter model characteristics. Data contained herein is generic in scope and not customer-specific.

For additional information contact:

Boeing Commercial Airplanes
2201 Seal Beach Blvd. M/C: 110-SB02
Seal Beach, CA 90740-1515
U.S.A.

Attention: Manager, Airport Compatibility Engineering

Email: AirportCompatibility@boeing.com

1.3 BRIEF DESCRIPTION OF THE 737 MAX FAMILY OF AIRPLANES

The 737 MAX is the latest series of derivative airplanes in the 737 family of airplanes. The 737 MAX airplanes include 737-7, 737-8, 737-8-200, 737-9, 737-10, and the Business Jet versions.

The 737 MAX series airplanes have improved fuel efficiency, increased payload or range, and reduced emissions and noise. The 737 MAX incorporates an all new CFM LEAP-1B engine for improved fuel-efficiency and reduced community noise. One of the characteristics new to the 737 MAX family which improves operational efficiency is the new Advanced Technology (AT) winglet with a distinctive dual-feather configuration to improve aerodynamics.

The 737 MAX family remains a Federal Aviation Administration (FAA) Airplane Design Group III and International Civil Aviation Organization (ICAO) Aerodrome Reference Code Letter C aircraft.

1.4 CONVERSION FACTORS

The data in this manual is provided in both English and Metric units. Unless otherwise stated, the conversions listed below are used throughout this manual.

MULTIPLY	BY	TO OBTAIN
Pounds	0.45359237	Kilograms
U.S. Gallons	3.78541180	Liters
Inches	2.54000000	Centimeters
Feet	0.30480000	Meters

When totals or summations are required the English values are summed separately from the Metric values. Differences may occur when comparing the English total with metric totals due to rounding.

All metric values are converted from English values. When using the conversion factors in this manual, all resultants will be rounded except when the value is a weight limitation. For minimum or maximum weight limitations the resultant metric values will be rounded up or truncated, whichever is more conservative.

2.0 AIRPLANE DESCRIPTION

2.1 GENERAL CHARACTERISTICS

Maximum Design Taxi Weight (MTW). Maximum weight for ground maneuver as limited by aircraft strength and airworthiness requirements. (It includes weight of taxi and run-up fuel.)

Maximum Design Takeoff Weight (MTOW). Maximum weight for takeoff as limited by aircraft strength and airworthiness requirements. (This is the maximum weight at start of the takeoff run.)

Maximum Design Landing Weight (MLW). Maximum weight for landing as limited by aircraft strength and airworthiness requirements.

Maximum Design Zero Fuel Weight (MZFW). Maximum weight allowed before usable fuel and other specified usable agents must be loaded in defined sections of the aircraft as limited by strength and airworthiness requirements.

Operating Empty Weight (OEW). Weight of structure, powerplant, furnishing systems, unusable fuel and other unusable propulsion agents, and other items of equipment that are considered an integral part of a particular airplane configuration. Also included are certain standard items, personnel, equipment, and supplies necessary for full operations, excluding usable fuel and payload.

Maximum Payload. Maximum design zero fuel weight minus operational empty weight.

Maximum Seating Capacity. The maximum number of passengers specifically certificated or anticipated for certification.

Maximum Cargo Volume. The maximum space available for cargo.

Usable Fuel. Fuel available for aircraft propulsion.

2.1.1 General Characteristics: Model 737-7

CHARACTERISTICS	UNITS	MODEL 737-7
MAX DESIGN TAXI WEIGHT	POUNDS	177,500
	KILOGRAMS	80,512
MAX DESIGN TAKEOFF WEIGHT	POUNDS	177,000
	KILOGRAMS	80,285
MAX DESIGN LANDING WEIGHT	POUNDS	145,600
	KILOGRAMS	66,043
MAX DESIGN ZERO FUEL WEIGHT	POUNDS	138,700
	KILOGRAMS	62,913
SEATING CAPACITY	TWO-CLASS	153
	SINGLE-CLASS	172
MAX CARGO VOLUME - LOWER DECK	CUBIC FEET	1,139
	CUBIC METERS	32.3
USABLE FUEL *[1]	US GALLONS	6,820
	LITERS	25,816
	POUNDS	45,694
	KILOGRAMS	20,730

NOTES:

*[1] FUEL DENSITY = 6.7 LBS/US GAL

2.1.2 General Characteristics: Model 737-8 / -8-200

CHARACTERISTICS	UNITS	MODEL 737-8	MODEL 737-8-200
MAX DESIGN TAXI WEIGHT	POUNDS	181,700	181,700
	KILOGRAMS	82,417	82,417
MAX DESIGN TAKEOFF WEIGHT	POUNDS	181,200	181,200
	KILOGRAMS	82,190	82,190
MAX DESIGN LANDING WEIGHT	POUNDS	152,800	152,800
	KILOGRAMS	69,308	69,308
MAX DESIGN ZERO FUEL WEIGHT	POUNDS	145,400	145,400
	KILOGRAMS	65,952	65,952
SEATING CAPACITY	TWO-CLASS	178	*[2]
	SINGLE-CLASS	189	200
MAX CARGO VOLUME - LOWER DECK	CUBIC FEET	1,540	1,540
	CUBIC METERS	43.6	43.6
USABLE FUEL *[1]	US GALLONS	6,820	6,820
	LITERS	25,817	25,817
	POUNDS	45,694	45,694
	KILOGRAMS	20,731	20,731

NOTES:

*[1] FUEL DENSITY = 6.7 LBS/US GAL

*[2] ONLY SINGLE-CLASS LAYOUT

2.1.3 General Characteristics: Model BBJ MAX 8

CHARACTERISTICS	UNITS	MODEL BBJ MAX 8
MAX DESIGN TAXI WEIGHT	POUNDS	181,700
	KILOGRAMS	82,417
MAX DESIGN TAKEOFF WEIGHT	POUNDS	181,200
	KILOGRAMS	82,190
MAX DESIGN LANDING WEIGHT	POUNDS	152,800
	KILOGRAMS	69,308
MAX DESIGN ZERO FUEL WEIGHT	POUNDS	145,400
	KILOGRAMS	65,952
SEATING CAPACITY	TWO-CLASS	*[1]
	SINGLE-CLASS	*[1]

AUXILIARY TANK CONFIGURATIONS: LOWER DECK MAXIMUM CARGO VOLUME AND USABLE FUEL *[2]											
	NUMBER OF AUXILIARY FUEL TANKS										
	0	0	0	0	0	1	1	2	1	2	2
	0	1	2	3	4	3	4	3	5	4	5
TOTAL CARGO (CU FT)	1,526	1,272	1,272	1,176	1,066	968	858	855	746	745	633
TOTAL CARGO (CU M)	43.2	36.0	36.0	33.3	30.2	27.4	24.3	24.2	21.1	21.1	17.9
FUEL (US GAL)	6,820	7,335	7,791	8,310	8,834	8,802	9,326	9,325	9,871	9,849	10,394
FUEL (LITER)	25,816	27,765	29,492	31,456	33,440	33,319	35,302	35,298	37,365	37,282	39,345
FUEL (LBS)	45,694	49,145	52,200	55,677	59,188	58,973	62,484	62,478	66,136	65,988	69,640
FUEL (KGS)	20,730	22,295	23,682	22,259	26,852	26,755	28,347	28,344	30,004	29,937	31,594

NOTES:

*[1] BBJ LAYOUTS ARE CUSTOMIZED

*[2] FUEL DENSITY = 6.7 LBS/US GAL

2.1.4 General Characteristics: Model 737-9

CHARACTERISTICS	UNITS	MODEL 737-9
MAX DESIGN TAXI WEIGHT	POUNDS	195,200
	KILOGRAMS	88,541
MAX DESIGN TAKEOFF WEIGHT	POUNDS	194,700
	KILOGRAMS	88,314
MAX DESIGN LANDING WEIGHT	POUNDS	163,900
	KILOGRAMS	74,343
MAX DESIGN ZERO FUEL WEIGHT	POUNDS	156,500
	KILOGRAMS	70,987
SEATING CAPACITY	TWO-CLASS	193
	SINGLE-CLASS	220
MAX CARGO VOLUME LOWER DECK	CUBIC FEET	1,811
	CUBIC METERS	51.3
USABLE FUEL *[1]	US GALLONS	6,820
	LITERS	25,817
	POUNDS	45,694
	KILOGRAMS	20,731

NOTES:

*[1] FUEL DENSITY = 6.7 LBS/US GAL

2.2 GENERAL DIMENSIONS

2.2.1 General Dimensions: Model 737-7

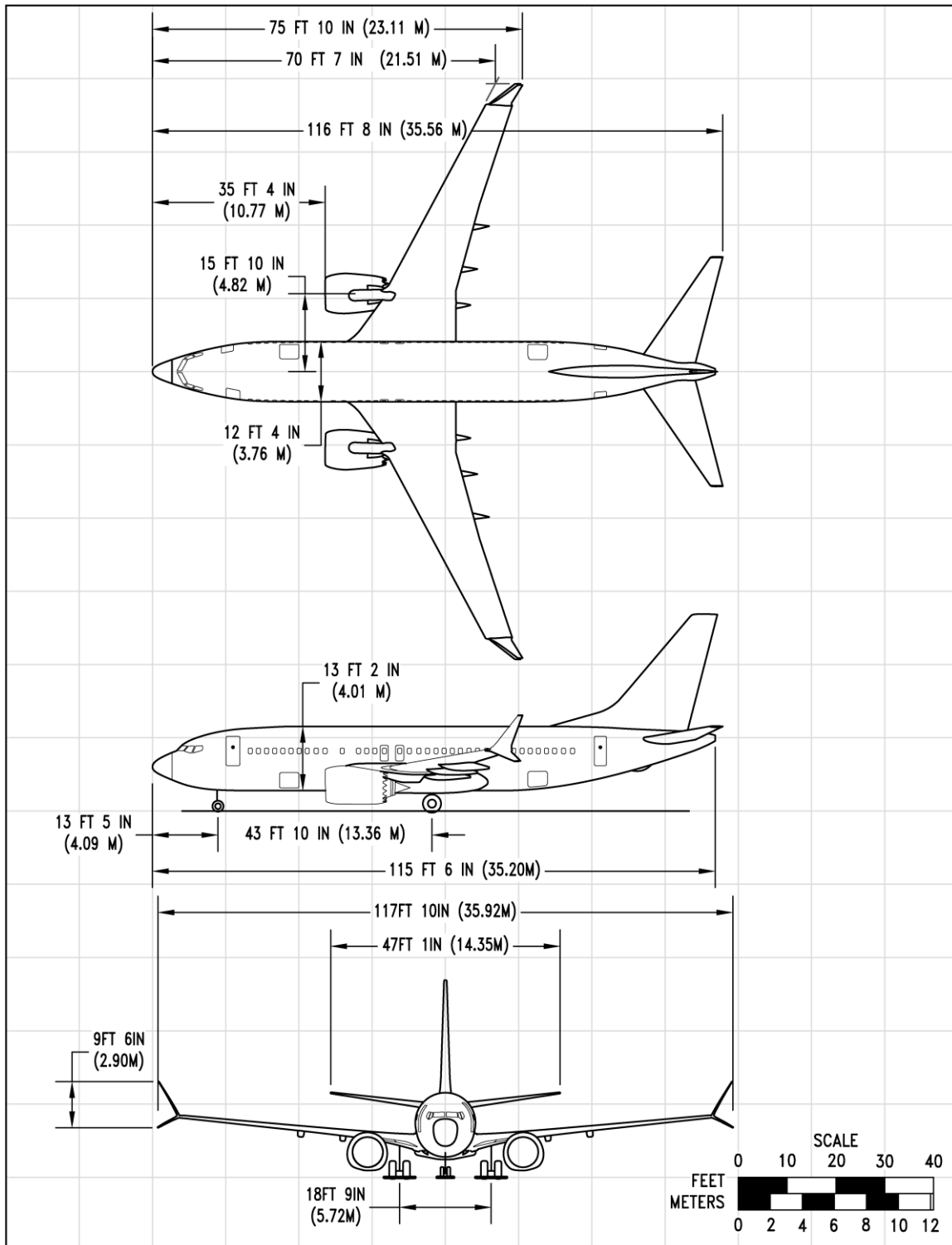

NOTE: THESE DRAWINGS ARE USED FOR AIRPORT PLANNING PURPOSES. THEY ARE ACCURATE WITHIN +/- 6 INCHES.

2.2.2 General Dimensions: Model 737-8 / -8-200 / BBJ MAX 8

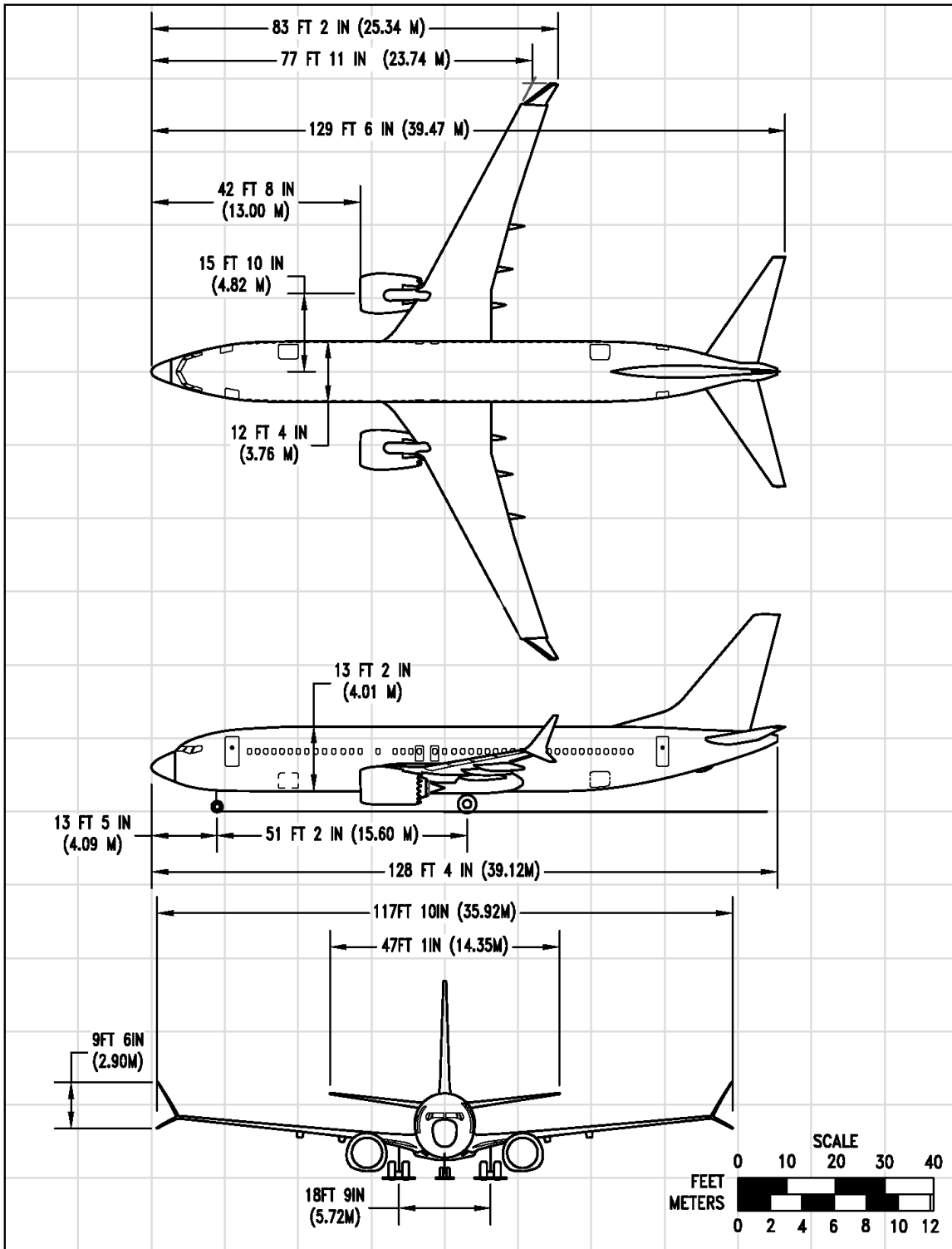

NOTE: THESE DRAWINGS ARE USED FOR AIRPORT PLANNING PURPOSES. THEY ARE ACCURATE WITHIN +/- 6 INCHES.

2.2.3 General Dimensions: Model 737-9

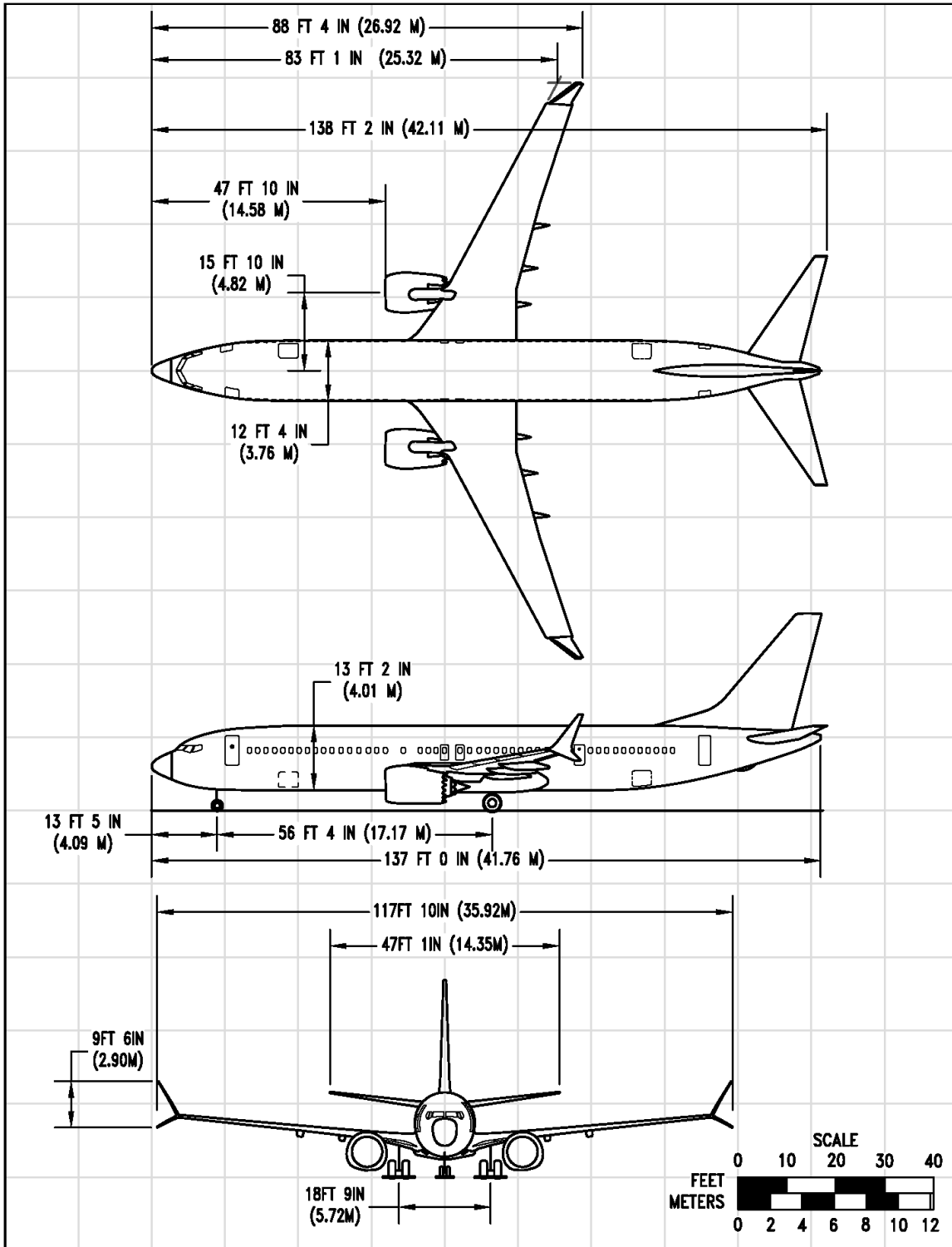

NOTE: THESE DRAWINGS ARE USED FOR AIRPORT PLANNING PURPOSES. THEY ARE ACCURATE WITHIN +/- 6 INCHES.

2.3 GROUND CLEARANCES

2.3.1 Ground Clearances: Model 737-7

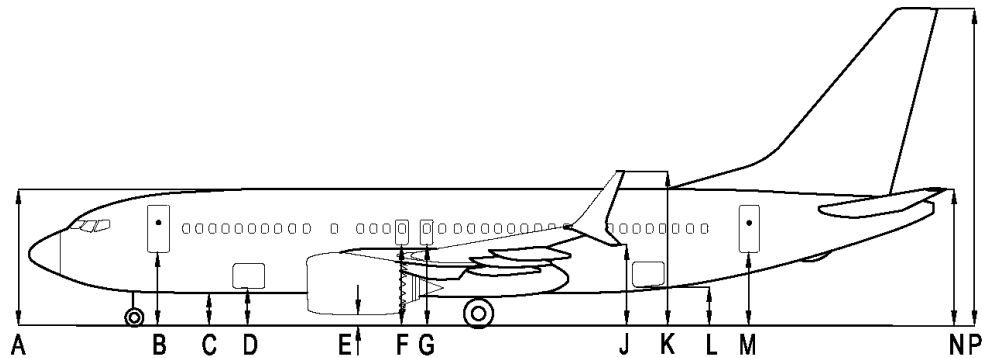

DESCRIPTION	737-7 *[1]			
	MINIMUM		MAXIMUM	
	FT - IN	M	FT - IN	M
A FUSELAGE - TOP	16-7	5.05	18-1	5.51
B FORWARD DOOR, LEFT & RIGHT	9-1	2.77	10-1	3.07
C FUSELAGE - BOTTOM	4-2	1.27	5-1	1.55
D FORWARD CARGO DOOR	4-8	1.42	5-6	1.68
E ENGINE	1-5	0.43	1-10	0.56
F FORWARD OVERWING EXIT DOOR, LEFT & RIGHT	10-2	3.10	10-7	3.23
G AFT OVERWING EXIT, LEFT & RIGHT	10-2	3.10	10-6	3.20
J WINGLET BLADE, LOWER	9-2	2.79	10-4	3.15
K WINGLET BLADE, UPPER	18-9	5.72	19-11	6.07
L AFT CARGO DOOR	4-4	1.32	5-5	1.65
M AFT PASSENGER DOOR, LEFT & RIGHT	8-2	2.49	9-7	2.92
N HORIZONTAL STABILIZER	15-8	4.78	17-8	5.38
P VERTICAL STABILIZER	38-10	11.84	41-0	12.50

NOTES:

*[1] CLEARANCES SHOWN ARE NOMINAL. ADD PLUS OR MINUS 3 INCHES TO ACCOUNT FOR VARIATIONS IN LOADING, OLEO AND TIRE PRESSURES, CENTER OF GRAVITY, ETC. DURING ROUTINE SERVICING, THE AIRPLANE REMAINS RELATIVELY STABLE, PITCH AND ELEVATION CHANGES OCCURRING SLOWLY.

2.3.2 Ground Clearances: Model 737-8 / -8-200 / BBJ MAX 8

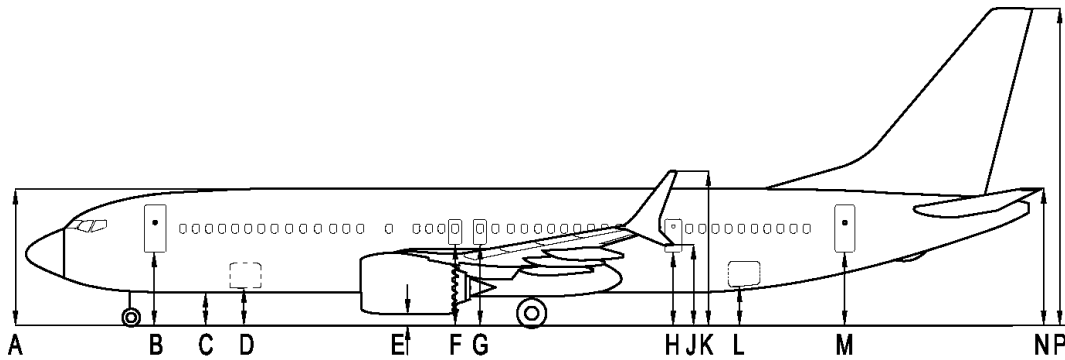

DESCRIPTION	737-8 / -8-200 / BBJ MAX 8 *[1]			
	MINIMUM		MAXIMUM	
	FT - IN	M	FT - IN	M
A FUSELAGE - TOP	16-8	5.08	18-1	5.51
B FORWARD DOOR, LEFT & RIGHT	9-1	2.77	10-1	3.07
C FUSELAGE - BOTTOM	4-2	1.27	5-1	1.55
D FORWARD CARGO DOOR	4-8	1.42	5-6	1.68
E ENGINE	1-5	0.43	1-10	0.56
F FORWARD OVERWING EXIT DOOR, LEFT & RIGHT	10-2	3.10	10-7	3.23
G AFT OVERWING EXIT, LEFT & RIGHT	10-2	3.10	10-6	3.20
H MID EXIT DOOR, LEFT & RIGHT *[2]	8-8	2.64	9-5	2.87
J WINGLET BLADE, LOWER	9-2	2.79	10-4	3.15
K WINGLET BLADE, UPPER	18-9	5.72	19-11	6.07
L AFT CARGO DOOR	4-4	1.32	5-5	1.65
M AFT PASSENGER DOOR, LEFT & RIGHT	8-2	2.49	9-6	2.90
N HORIZONTAL STABILIZER	15-8	4.78	17-7	5.36
P VERTICAL STABILIZER	38-11	11.86	40-10	12.45

NOTES:

*[1] CLEARANCES SHOWN ARE NOMINAL. ADD PLUS OR MINUS 3 INCHES TO ACCOUNT FOR VARIATIONS IN LOADING, OLEO AND TIRE PRESSURES, CENTER OF GRAVITY, ETC. DURING ROUTINE SERVICING, THE AIRPLANE REMAINS RELATIVELY STABLE, PITCH AND ELEVATION CHANGES OCCURRING SLOWLY.

*[2] MID EXIT DOOR ONLY EQUIPPED ON 737-8-200.

2.3.3 Ground Clearances: Model 737-9

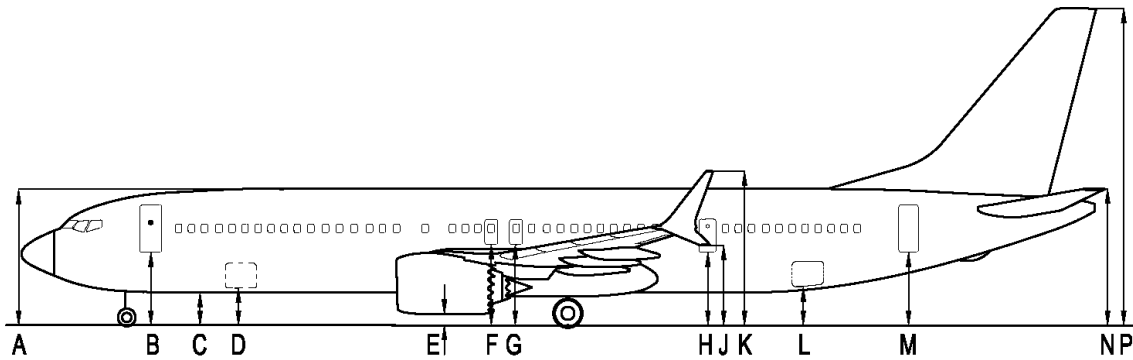

DESCRIPTION	737-9 *[1]			
	MINIMUM		MAXIMUM	
	FT - IN	M	FT - IN	M
A FUSELAGE - TOP	16-8	5.08	18-1	5.51
B FORWARD DOOR, LEFT & RIGHT	9-2	2.79	10-1	3.07
C FUSELAGE - BOTTOM	4-2	1.27	5-1	1.55
D FORWARD CARGO DOOR	4-9	1.45	5-6	1.68
E ENGINE	1-5	0.43	1-10	0.56
F FORWARD OVERWING EXIT DOOR, LEFT & RIGHT	10-2	3.10	10-5	3.18
G AFT OVERWING EXIT, LEFT & RIGHT	10-2	3.10	10-5	3.18
H MID EXIT DOOR, LEFT & RIGHT	8-9	2.67	9-5	2.87
J WINGLET BLADE, LOWER	9-2	2.79	10-4	3.15
K WINGLET BLADE, UPPER	18-9	5.72	19-11	6.07
L AFT CARGO DOOR	4-4	1.32	5-4	1.63
M AFT PASSENGER DOOR, LEFT & RIGHT	8-3	2.51	9-3	2.82
N HORIZONTAL STABILIZER	15-9	4.80	17-6	5.33
P VERTICAL STABILIZER	39-0	11.89	40-8	12.40

NOTE:

*[1] CLEARANCES SHOWN ARE NOMINAL. ADD PLUS OR MINUS 3 INCHES TO ACCOUNT FOR VARIATIONS IN LOADING, OLEO AND TIRE PRESSURES, CENTER OF GRAVITY, ETC. DURING ROUTINE SERVICING, THE AIRPLANE REMAINS RELATIVELY STABLE, PITCH AND ELEVATION CHANGES OCCURRING SLOWLY.

2.4 INTERIOR ARRANGEMENTS

2.4.1 Interior Arrangements: Model 737-7

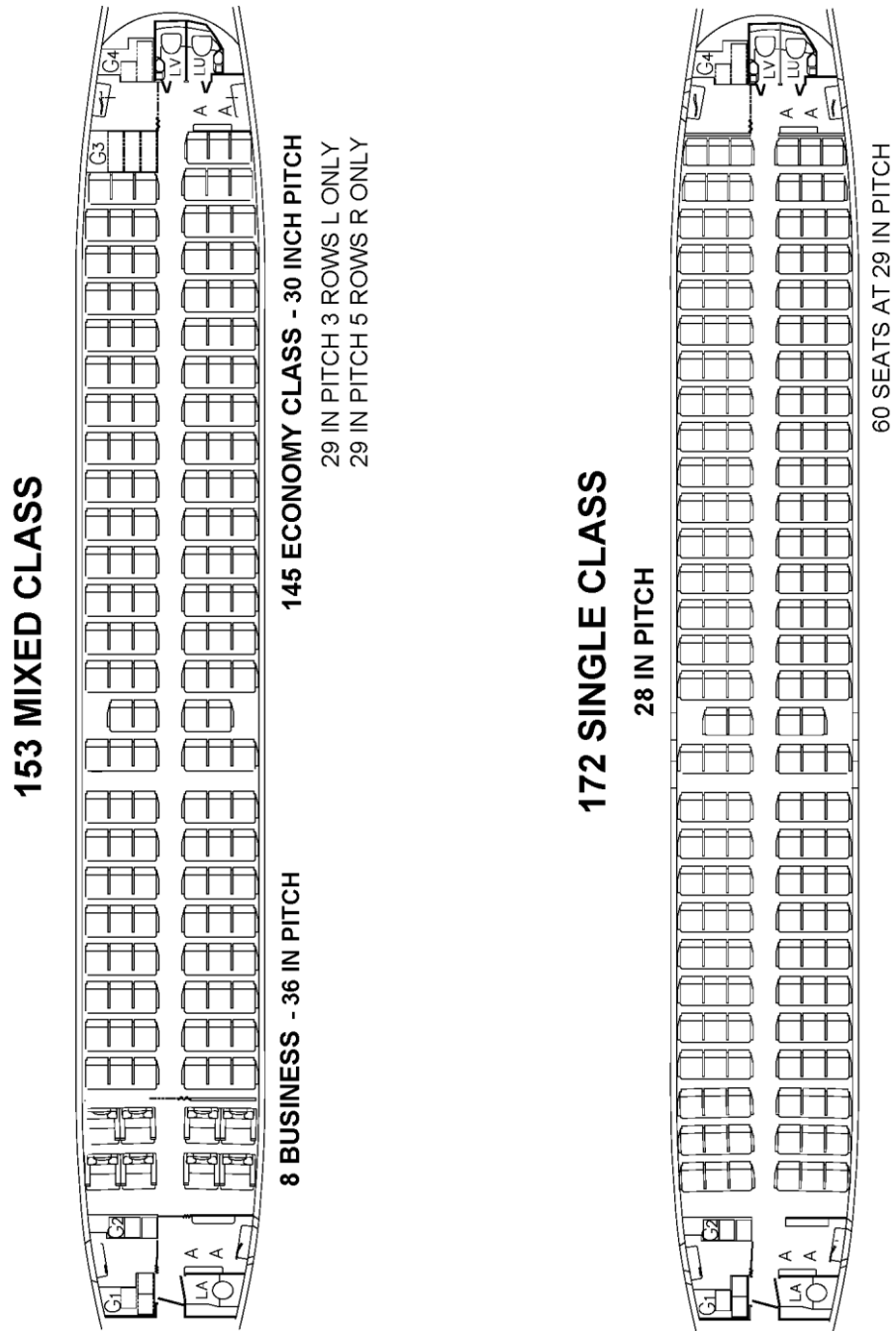

2.4.3 Interior Arrangements: Model 737-8-200

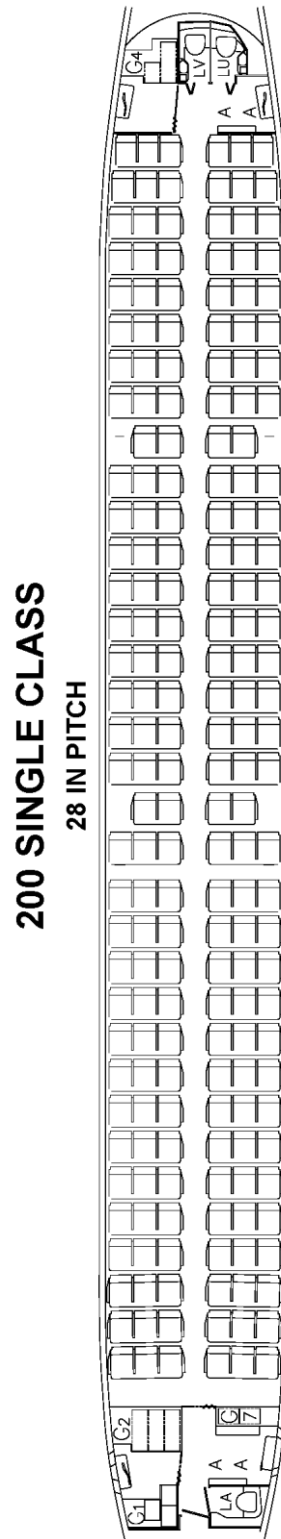

2.4.4 Interior Arrangements: Model 737-9

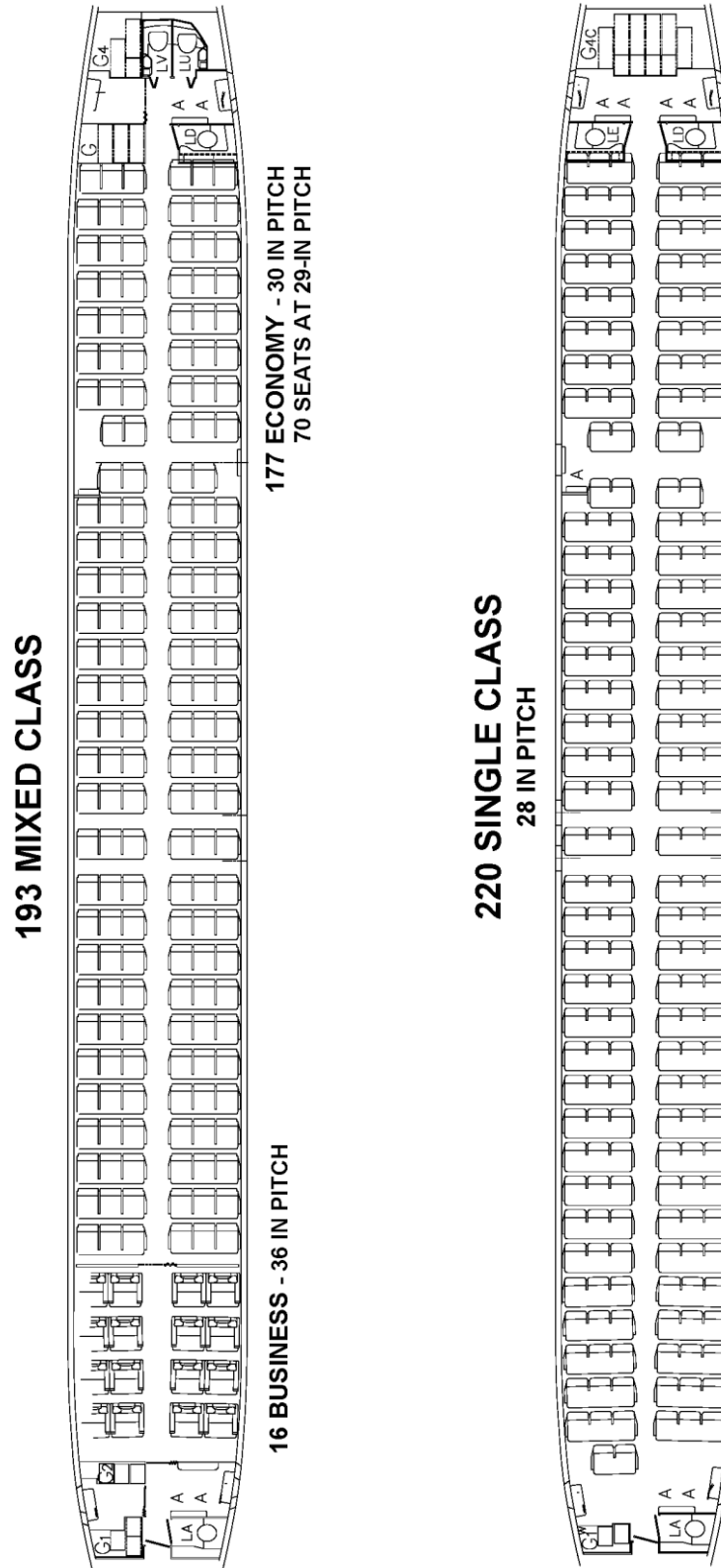

2.5 CABIN CROSS SECTIONS

2.5.1 Cabin Cross-Sections: All Models

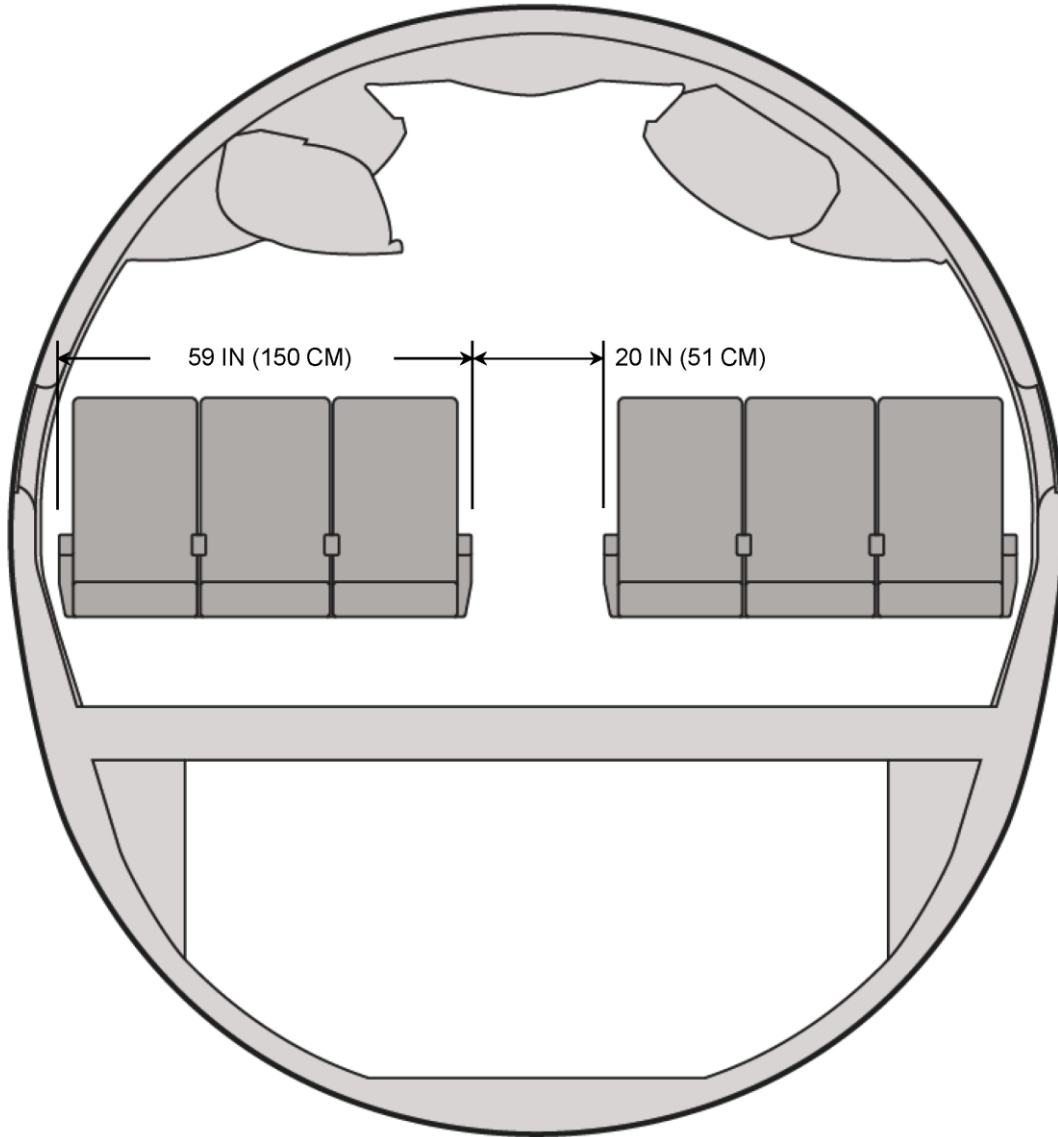

2.6 LOWER CARGO COMPARTMENTS

2.6.1 Lower Cargo Compartments: All Models

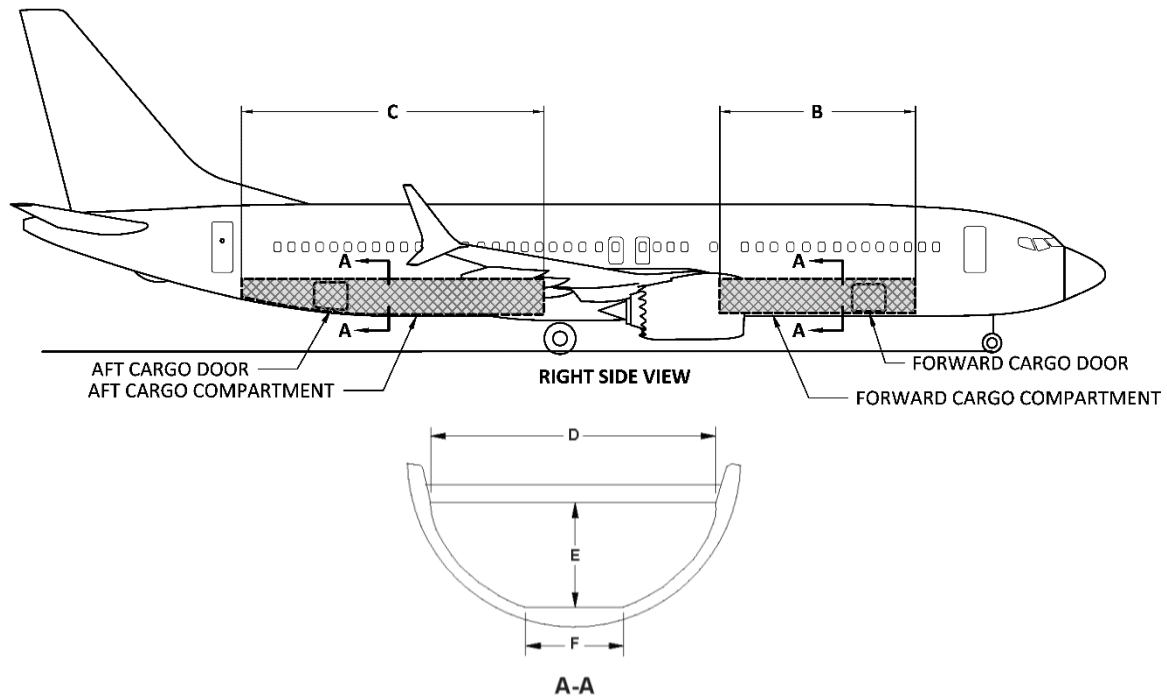

LOWER LOBE CARGO/BAGGAGE COMPARTMENT SIZES *[1]		
AIRPLANE MODEL	FORWARD COMPARTMENT (B) [1]	AFT COMPARTMENT (C)
737-7	17 FT - 4 IN (5.28 M)	30 FT - 3 IN (9.22 M)
737-8/-8-200/ BBJ MAX 8	24 FT - 8 IN (7.52 M)	35 FT - 9 IN (10.90 M)
737-9	29 FT - 10 IN (9.09 M)	39 FT - 3 IN (11.96 M)

SECT A-A	FORWARD CARGO COMPARTMENT	AFT CARGO COMPARTMENT FORWARD BULKHEAD	AFT CARGO COMPARTMENT AFT BULKHEAD
D	10 FT - 0 IN (3.05 M)	9 FT - 7 IN (2.92 M)	6 FT - 10 IN (2.08 M)
E	3 FT - 8 IN (1.12 M)	3 FT - 11 IN (1.19 M)	1 FT - 11 IN (0.59 M)
F	4 FT - 0 IN (1.22 M)	4 FT - 0 IN (1.22 M)	4 FT - 0 IN (1.22 M)

MAXIMUM LOWER LOBE CARGO/BAGGAGE COMPARTMENT VOLUMES *[1]			
AIRPLANE MODEL	FORWARD COMPARTMENT BULK CARGO	AFT COMPARTMENT BULK CARGO *[2]	TOTAL BULK CARGO
737-7	433 CU FT (12.3 CU M)	706 CU FT (20.0 CU M)	1,139 CU FT (32.3 CU M)
737-8/-8-200/ BBJ MAX 8	657 CU FT (18.6 CU M)	883 CU FT (25.0 CU M)	1,540 CU FT (43.6 CU M)
737-9	815 CU FT (23.1 CU M)	996 CU FT (28.2 CU M)	1,811 CU FT (51.3 CU M)

NOTES:

*[1] DOES NOT ACCOUNT FOR BBJ MAX 8 CONFIGURATIONS WITH AUXILIARY TANKS

*[2] OPTIONAL EXTENDED E6 RACK REDUCES CARGO VOLUME BY 14 CU FT (STANDARD ON BBJ MAX)

2.6.2 Lower Cargo Compartments: Model BBJ MAX 8

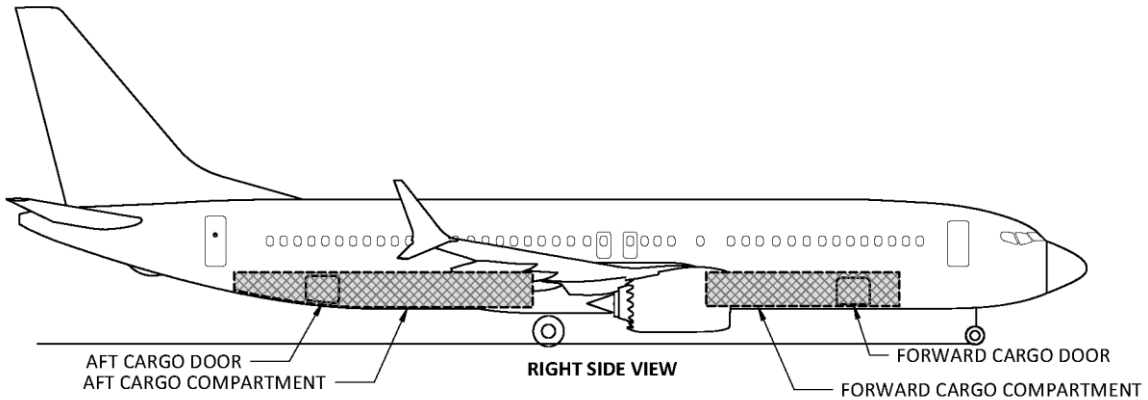

MAXIMUM LOWER LOBE CARGO/BAGGAGE COMPARTMENT VOLUMES				
FORWARD AUXILIARY TANKS	FORWARD COMPARTMENT BULK CARGO	AFT AUXILIARY TANKS	AFT COMPARTMENT BULK CARGO	TOTAL BULK CARGO
0	657 CU FT (18.6 CU M)	0	869 CU FT (24.6 CU M)	1,526 CU FT (43.2 CU M)
0	657 CU FT (18.6 CU M)	1	615 CU FT (17.4 CU M)	1,272 CU FT (36.0 CU M)
0	657 CU FT (18.6 CU M)	2	615 CU FT (17.4 CU M)	1,272 CU FT (36.0 CU M)
0	657 CU FT (18.6 CU M)	3	519 CU FT (14.7 CU M)	1,176 CU FT (33.3 CU M)
0	657 CU FT (18.6 CU M)	4	409 CU FT (11.6 CU M)	1,066 CU FT (30.2 CU M)
1	449 CU FT (12.7 CU M)	3	519 CU FT (14.7 CU M)	968 CU FT (27.4CU M)
1	449 CU FT (12.7 CU M)	4	409 CU FT (11.6 CU M)	858 CU FT (24.3 CU M)
2	336 CU FT (9.5 CU M)	3	519 CU FT (14.7 CU M)	855 CU FT (24.2 CU M)
1	449 CU FT (12.7 CU M)	5	297 CU FT (8.4 CU M)	746 CU FT (21.1 CU M)
2	336 CU FT (9.5 CU M)	4	409 CU FT (11.6 CU M)	745 CU FT (21.1 CU M)
2	336 CU FT (9.5 CU M)	5	297 CU FT (8.4 CU M)	633 CU FT (17.9 CU M)

2.7 DOOR CLEARANCES

2.7.1 Passenger and Cargo Door Locations: All Models

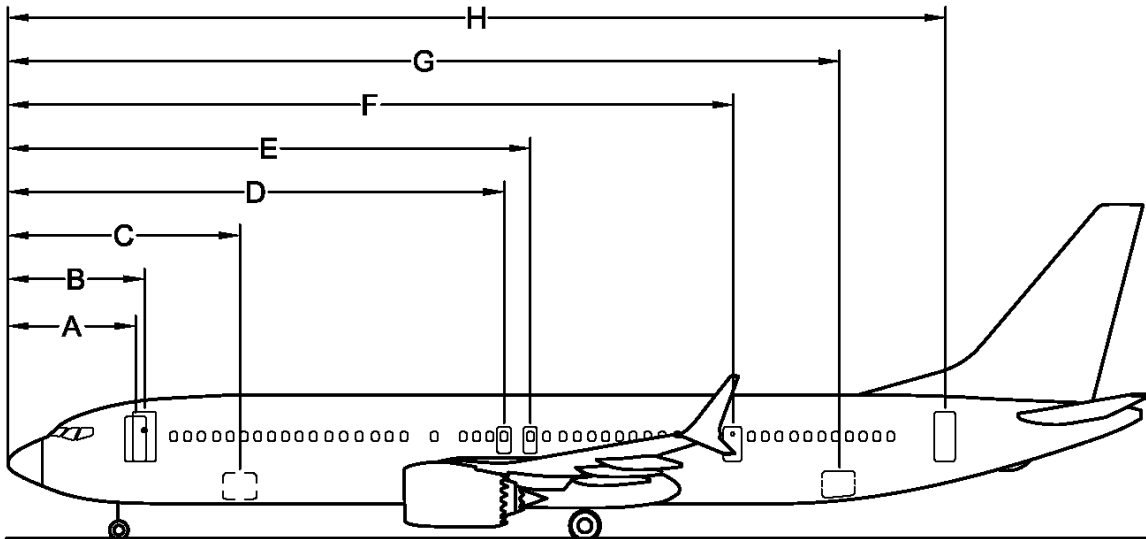

SEE NOTE *[3]

	DOOR NAME	DOOR LOCATION	737-7 FT-IN (M)	737-8/ BBJ MAX 8 FT-IN (M)	737-8-200 FT-IN (M)	737-9 FT-IN (M)
A	FWD SERVICE DOOR NO. 1	RIGHT	15-4 (4.67)	15-4 (4.67)	15-4 (4.67)	15-4 (4.67)
B	FWD MAIN ENTRY DOOR NO. 1	LEFT	16-6 (5.03)	16-6 (5.03)	16-6 (5.03)	16-6 (5.03)
C	FORWARD CARGO DOOR	RIGHT	28-0 (8.53)	28-0 (8.53)	28-0 (8.53)	28-0 (8.53)
D	EMERGENCY EXIT DOOR	LEFT AND RIGHT	47-6 (14.48)	54-10 (16.71)	54-10 (16.71)	60-0 (18.29)
E	EMERGENCY EXIT DOOR	LEFT AND RIGHT	50-8 (15.44)	58-0 (17.68)	58-0 (17.68)	63-2 (19.25)
F	MID EXIT DOOR *[1]	LEFT AND RIGHT	N/A	N/A	82-8 (25.20)	87-7 (26.70)
G	AFT CARGO DOOR	RIGHT	78-11 (24.05)	91-9 (27.97)	91-9 (27.97)	100-5 (30.61)
H	AFT ENTRY/SERVICE DOOR NO. 2 *[2]	LEFT AND RIGHT	91-9 (27.97)	104-7 (31.88)	104-7 (31.88)	113-3 (34.52)

NOTES:

- *[1] MID EXIT DOOR NOT ON 737-7 / -8 / BBJ MAX 8
- *[2] ENTRY DOORS LEFTSIDE, SERVICE DOORS RIGHTSIDE
- *[3] SEE SECTION 2.3 FOR DOOR SILL HEIGHTS

2.7.2 Door Clearances - Forward Main Entry Door: All Models

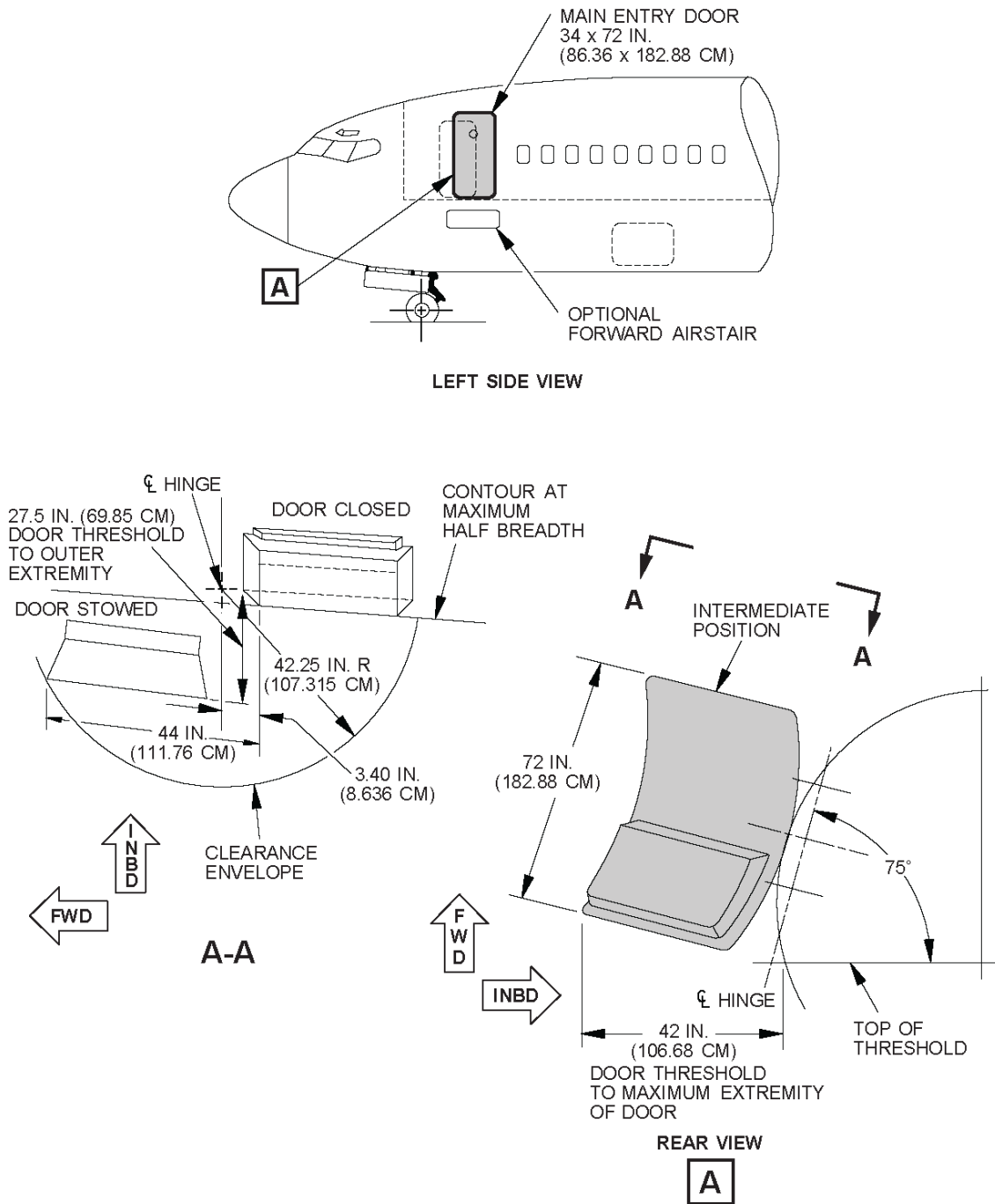

NOTE: SEE SEC 2.7.1 FOR DOOR LOCATION

2.7.3 Door Clearances - Optional Forward Airstairs, Forward Main Entry Door: All Models

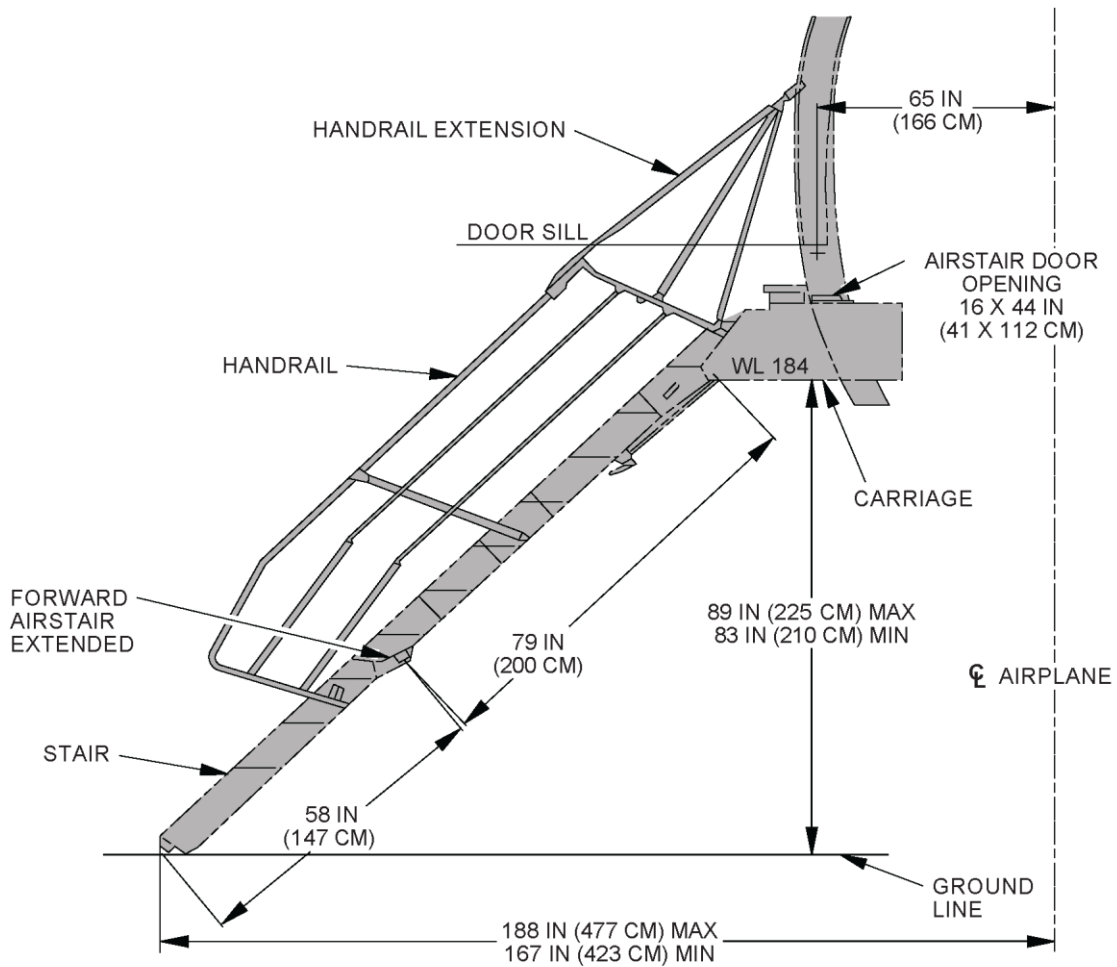

2.7.4 Door Clearances: Sensor and Probe Locations - Forward Cabin Doors: All Models

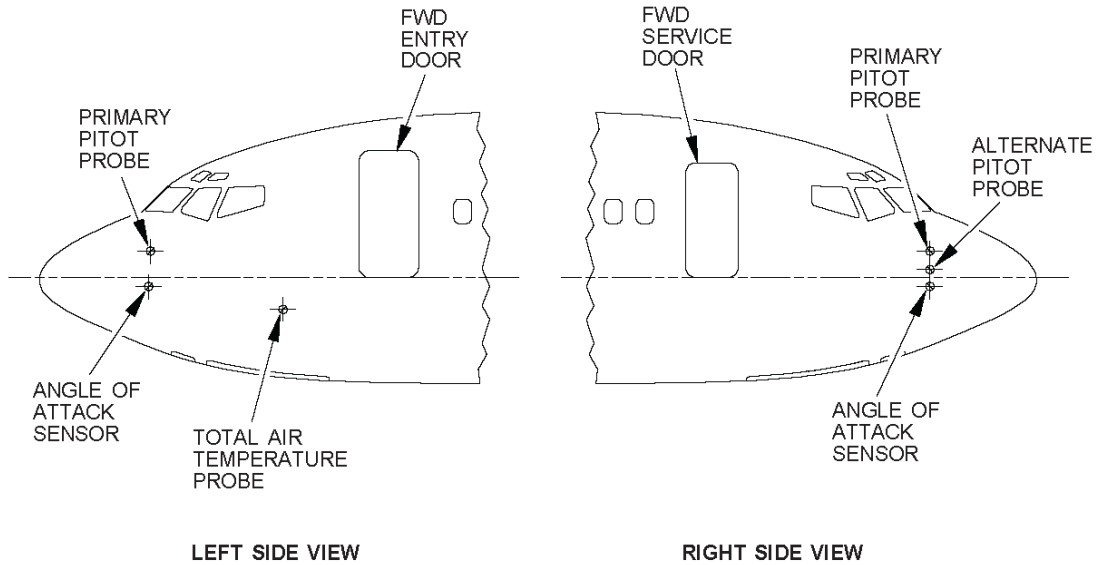

PROBE/SENSOR (SIDE)	DISTANCE AFT OF NOSE	DISTANCE ABOVE (+) OR BELOW (-) DOOR SILL REFERENCE LINE
PRIMARY PITOT (LEFT/RIGHT)	5 FT 2 IN (1.57 M)	+ 15 IN (0.38 M)
ALTERNATE PITOT (RIGHT)	5 FT 2 IN (1.57 M)	+ 3 IN (0.08 M)
ANGLE OF ATTACK (LEFT/RIGHT)	5 FT 2 IN (1.57 M)	- 6 IN (0.15 M)
TOTAL AIR TEMPERATURE (LEFT)	11 FT 6 IN (3.51 M)	- 18 IN (0.46 M)

2.7.5 Door Clearances – Forward Service Door: All Models

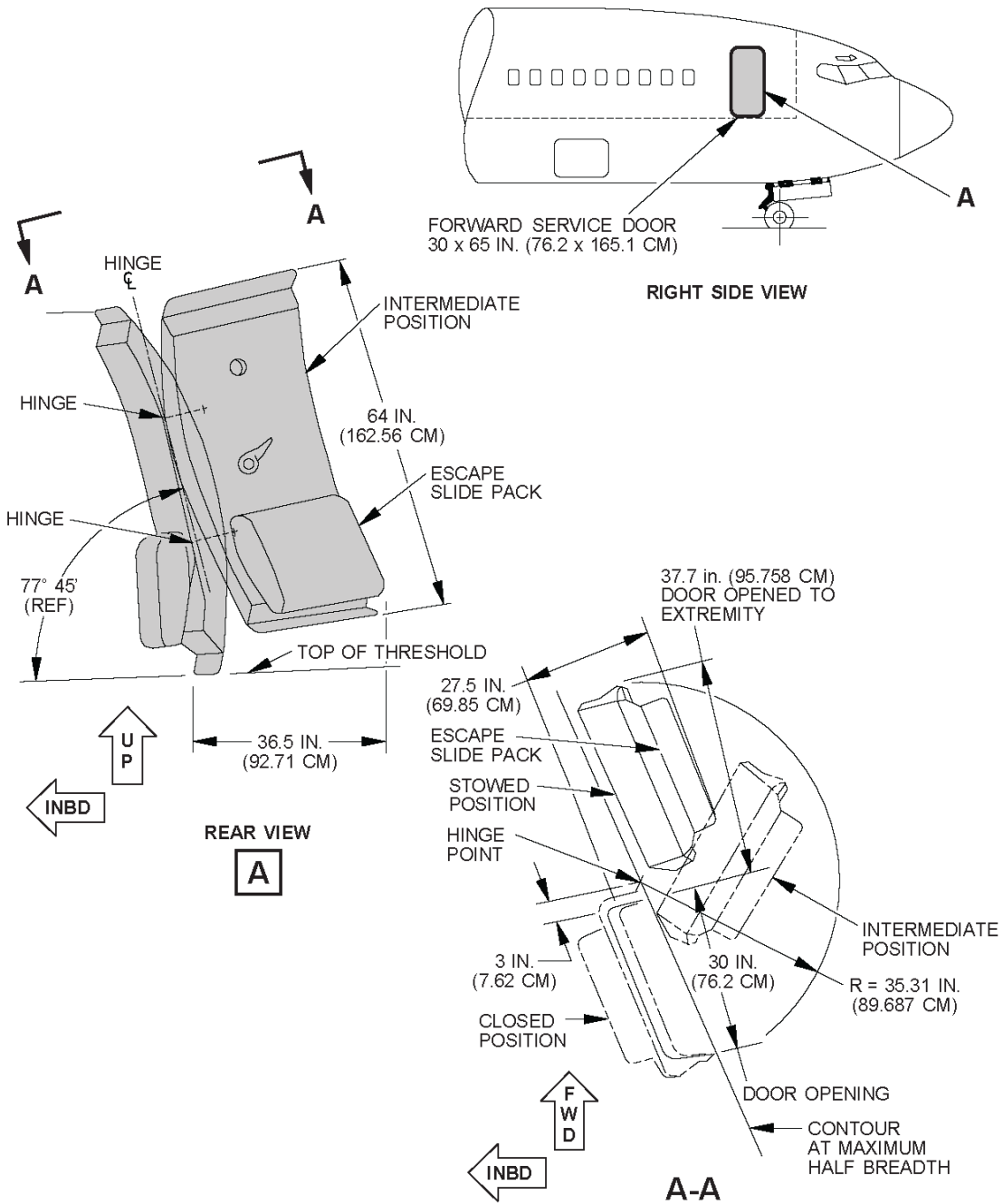

NOTE: SEE SEC 2.7.1 FOR DOOR LOCATION

2.7.6 Door Clearances - Aft Entry/Service Door: All Models

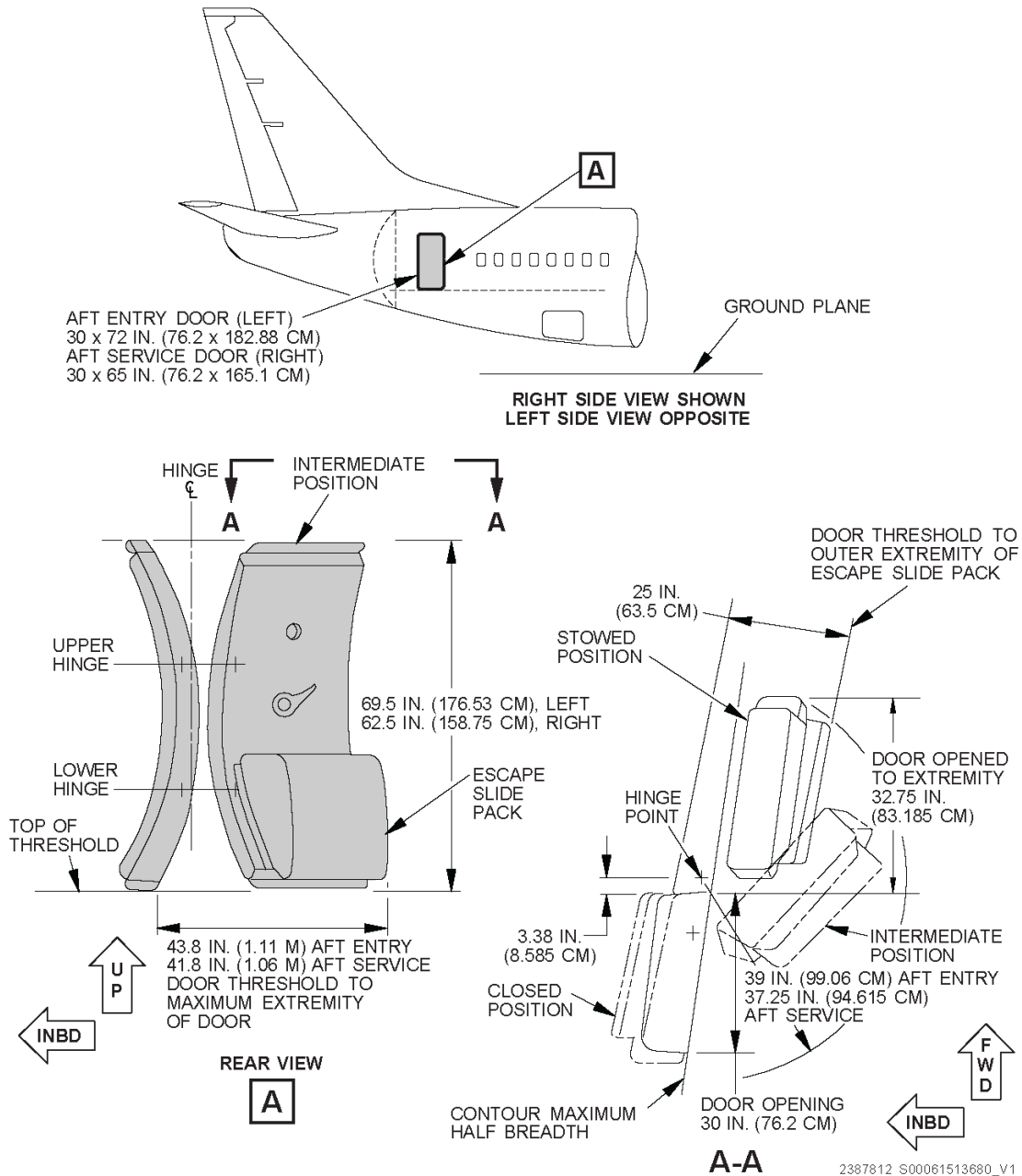

NOTE: SEE SEC 2.7.1 FOR DOOR LOCATION

2.7.7 Door Clearances - Lower Deck Cargo Compartments: All Models

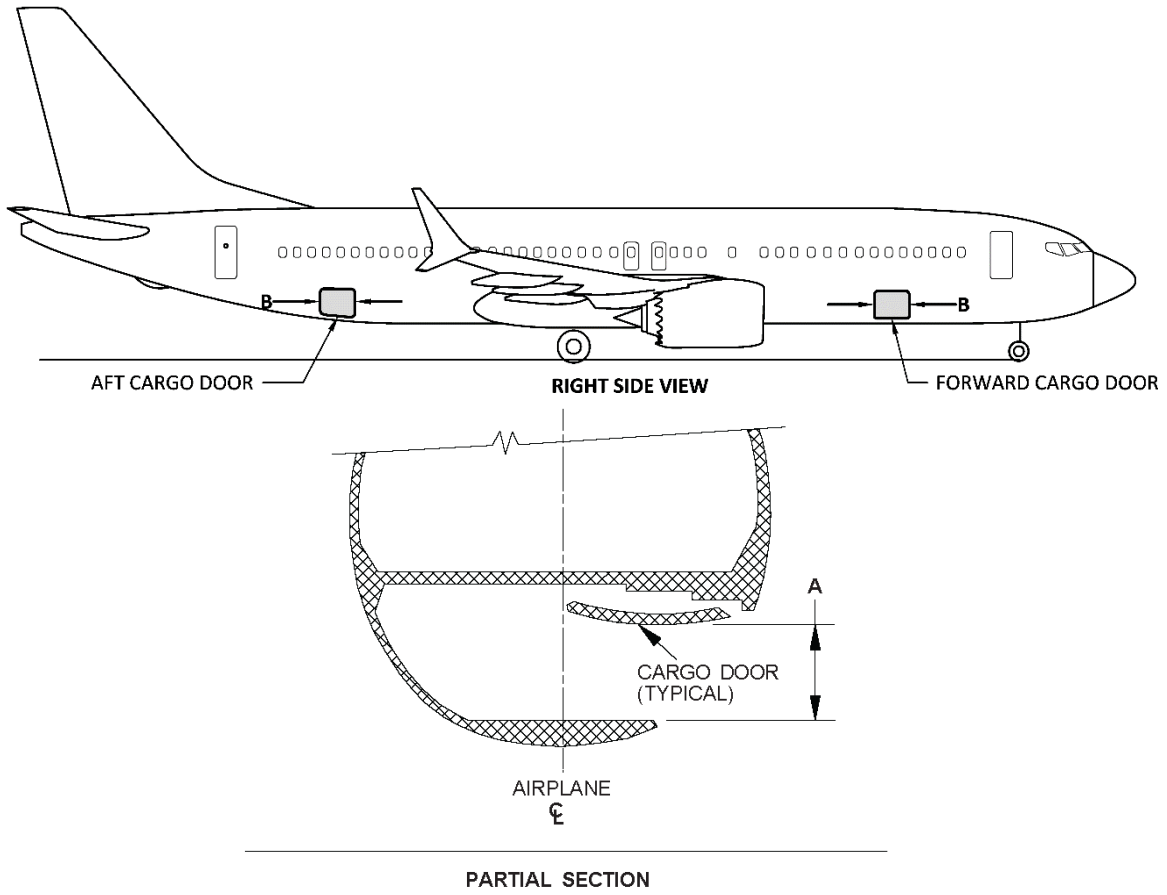

	DOOR SIZE	CLEAR OPENING (A x B)
FORWARD CARGO DOOR	51 x 48 IN (1.30 x 1.22 M)	33 x 48 IN (0.84 x 1.22 M)
AFT CARGO DOOR	48 x 48 IN (1.22 x 1.22 M)	33 x 48 IN (0.84 x 1.22 M)

NOTE: SEE SEC 2.7.1 FOR DOOR LOCATIONS

3.0 AIRPLANE PERFORMANCE

3.1 GENERAL INFORMATION

The graphs in Section 3.2 provide information on payload-range capability of the 737 MAX airplane. To use these graphs, if the trip range and zero fuel weight (OEW + payload) are known, the approximate takeoff weight can be found, limited by maximum zero fuel weight, maximum design takeoff weight, or fuel capacity.

The graphs in Section 3.3 provide information on FAA/EASA takeoff runway length requirements with typical engines at different pressure altitudes. Maximum takeoff weights shown on the graphs are the heaviest for the particular airplane models with the corresponding engines. Standard day temperatures for pressure altitudes shown on the FAA/EASA takeoff graphs are given below:

PRESSURE ALTITUDE		STANDARD DAY TEMP	
FEET	METERS	°F	°C
0	0	59.0	15.0
2,000	610	51.9	11.0
4,000	1,219	44.7	7.1
6,000	1,829	37.6	3.1
8,000	2,438	30.5	-0.8
10,000	3,048	23.3	-4.8
12,000	3,658	16.2	-8.8
14,000	4,267	9.1	-12.7

The graphs in Section 3.4 provide information on landing runway length requirements for different airplane weights and airport altitudes. The maximum landing weights shown are the heaviest for the particular airplane model.

3.2 PAYLOAD/RANGE FOR LONG RANGE CRUISE

3.2.1 Payload/Range for Long Range Cruise: Model 737-7 / -8-200

DATA TO BE PROVIDED
AT A LATER DATE

3.2.2 Payload/Range for Long Range Cruise: Model 737-8

Payload/Range
737-8 (LEAP-1B series)

- STANDARD DAY, ZERO WIND
- CRUISE MACH = LRC
- NORMAL POWER EXTRACTION AND AIR CONDITIONING BLEEDS
- TYPICAL MISSION RULES
- CONSULT USING AIRLINE FOR SPECIFIC OPERATING PROCEDURE AND OEW PRIOR TO FACILITY DESIGN.

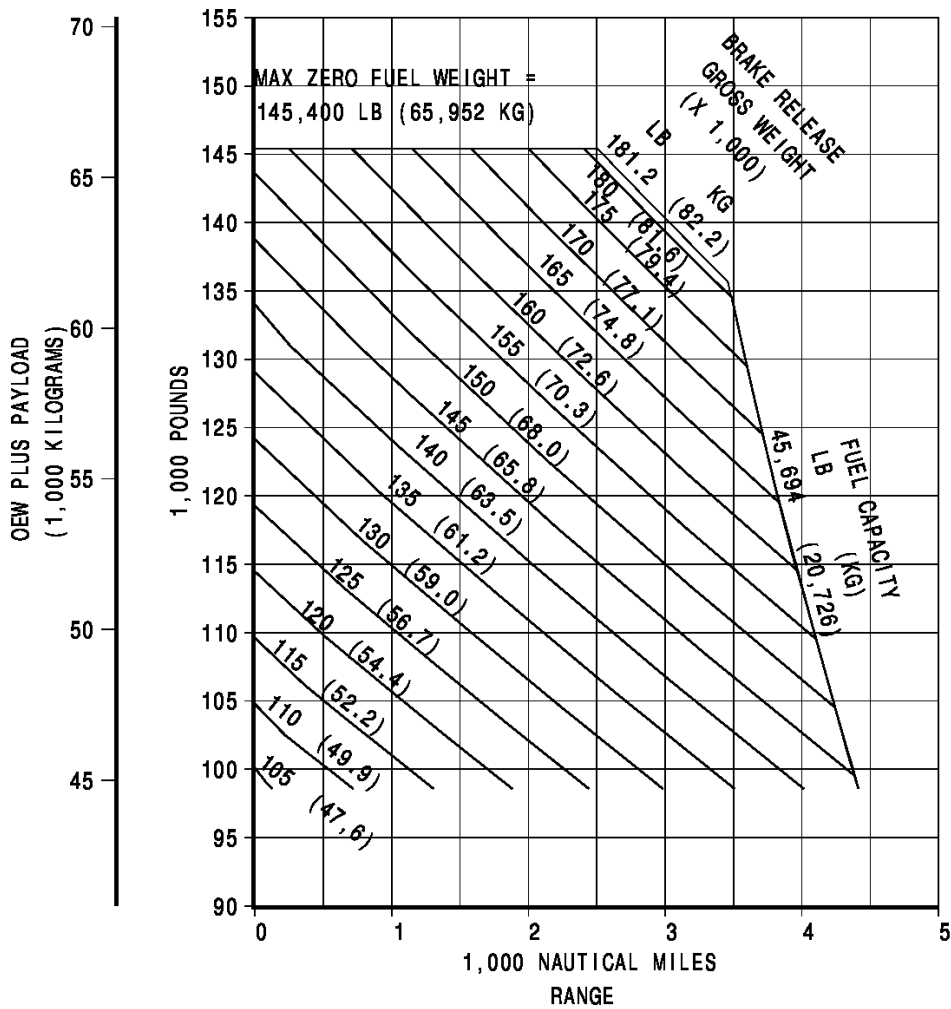

3.2.3 Payload/Range for Long Range Cruise: Model BBJ MAX 8

Payload/Range
BBJ MAX 8 (LEAP-1B series)

- STANDARD DAY, ZERO WIND
- CRUISE MACH = LRC
- NORMAL POWER EXTRACTION AND AIR CONDITIONING BLEEDS
- TYPICAL MISSION RULES
- CONSULT USING AIRLINE FOR SPECIFIC OPERATING PROCEDURE AND OEW PRIOR TO FACILITY DESIGN.

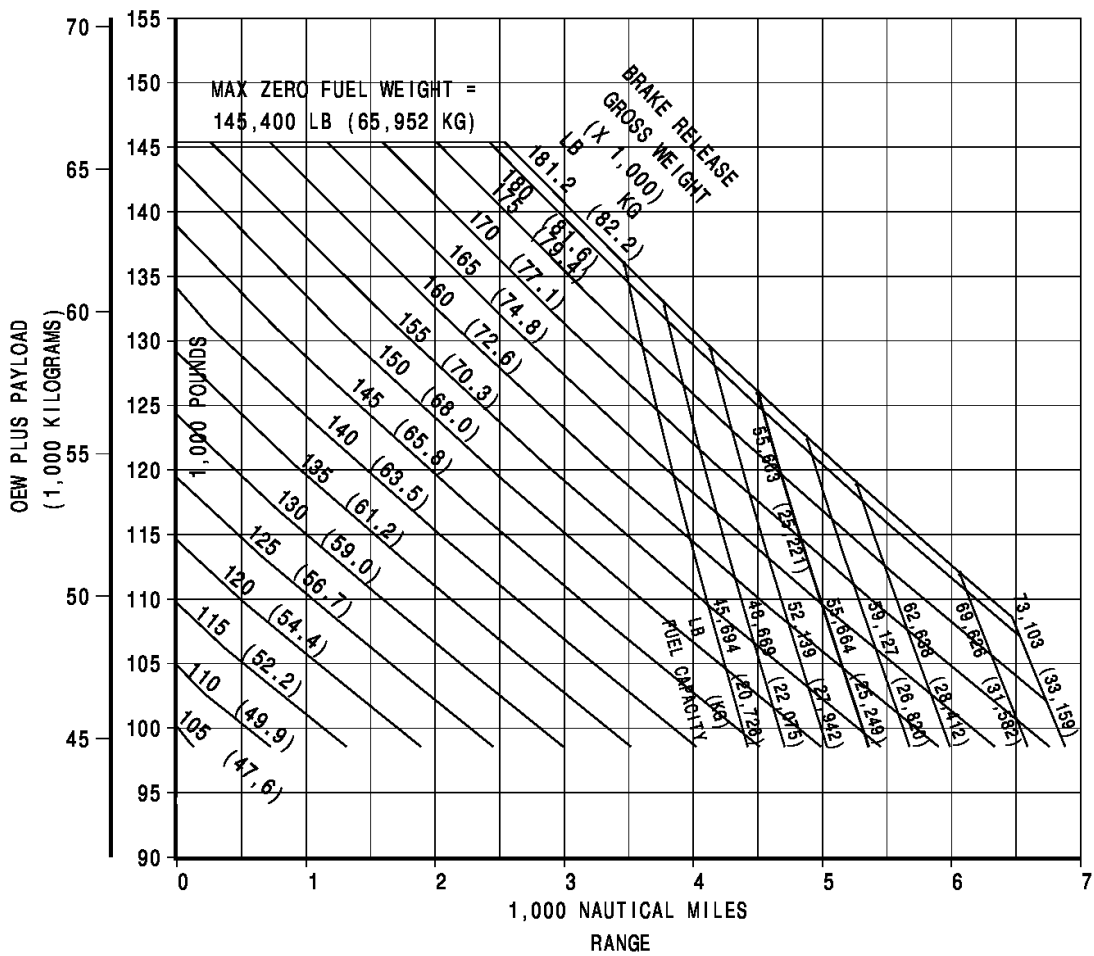

3.2.4 Payload/Range for Long Range Cruise: Model 737-9

**Payload/Range
737-9 (LEAP-1B Series)**

- STANDARD DAY, ZERO WIND
- CRUISE MACH = LRC
- NORMAL POWER EXTRACTION AND AIR CONDITIONING BLEEDS
- TYPICAL MISSION RULES
- CONSULT USING AIRLINE FOR SPECIFIC OPERATING PROCEDURE AND OEW PRIOR TO FACILITY DESIGN.

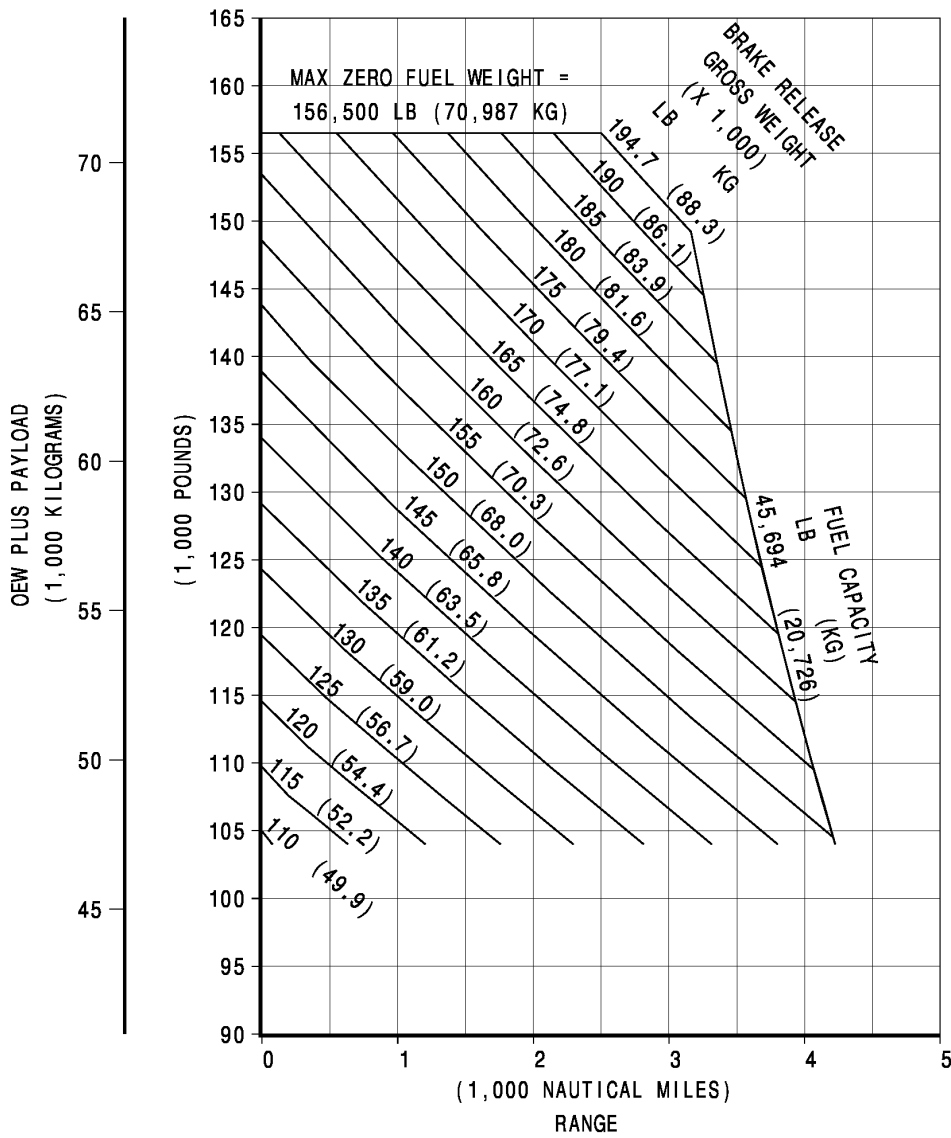

3.3 FAA/EASA TAKEOFF RUNWAY LENGTH REQUIREMENTS

**3.3.1 FAA/EASA Takeoff Runway Length Requirements: Model 737-7 /
-8-200**

DATA TO BE PROVIDED
AT A LATER DATE

3.3.2 FAA/EASA Takeoff Runway Length Requirements - Standard Day, Dry Runway: Model 737-8 (LEAP-1B25 Engine)

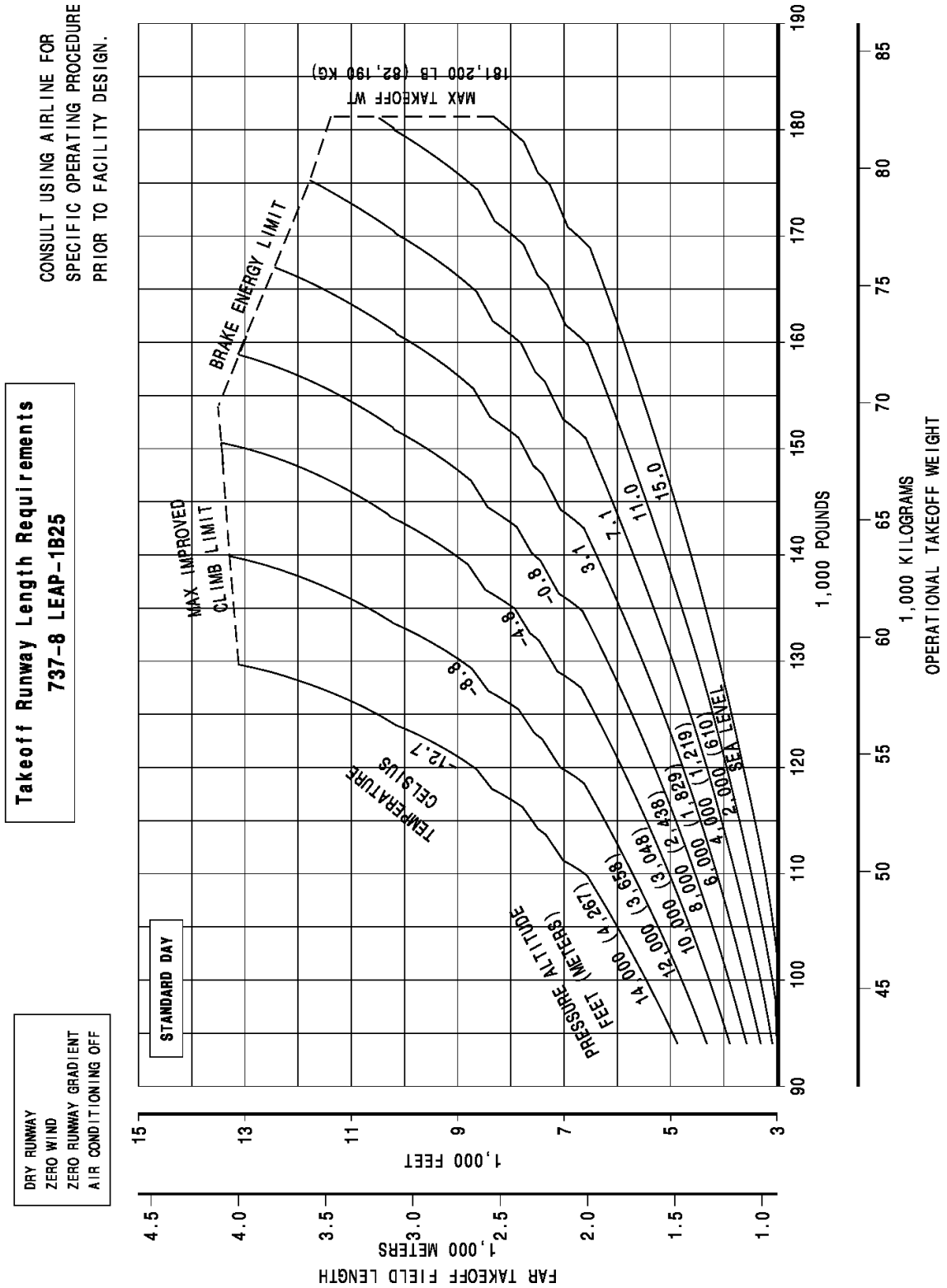

3.3.3 FAA/EASA Takeoff Runway Length Requirements - Standard Day + 27°F (STD + 15°C), Dry Runway: Model 737-8 (LEAP-1B25 Engine)

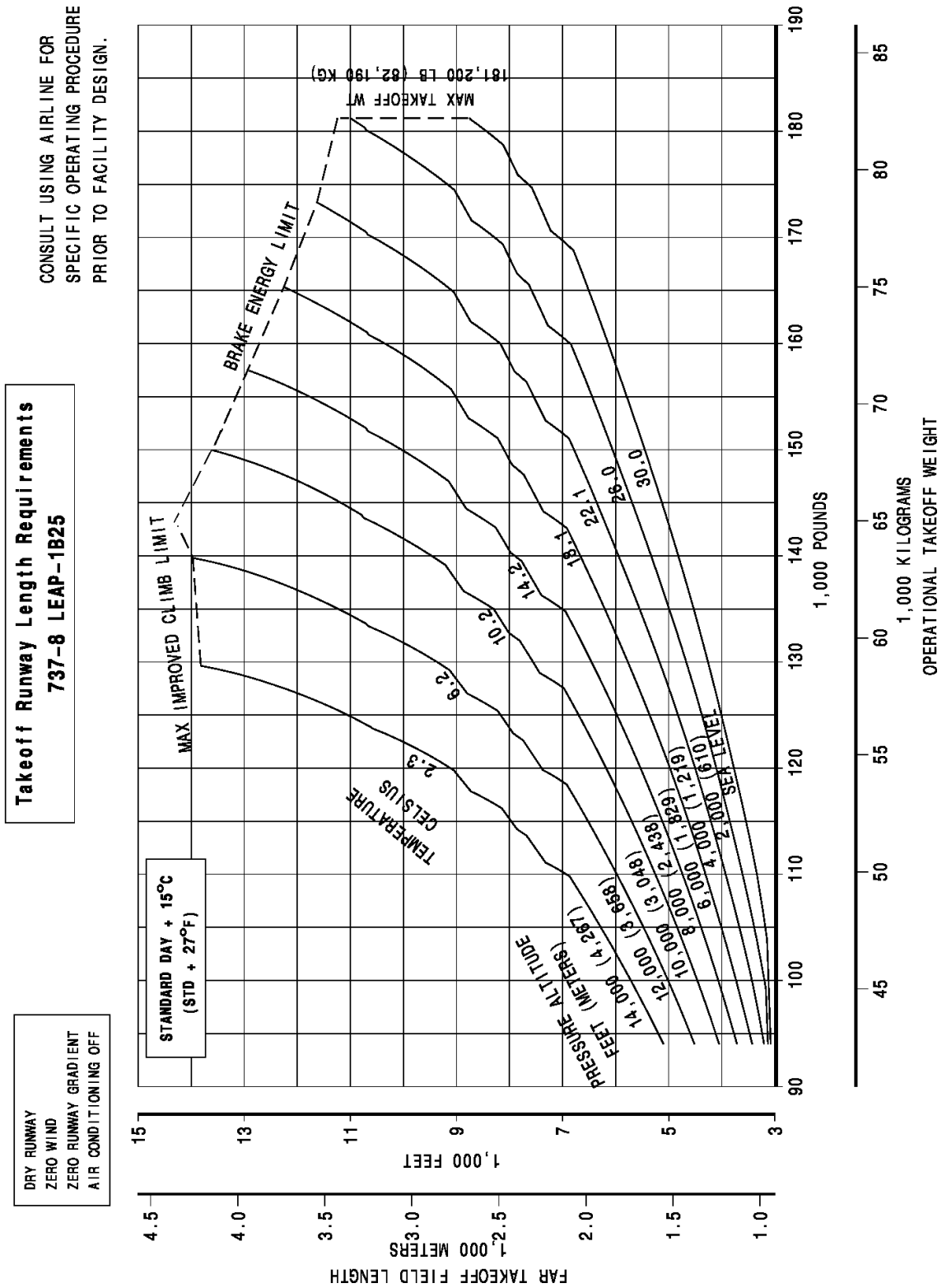

3.3.4 FAA/EASA Takeoff Runway Length Requirements - Standard Day + 45°F (STD + 25°C), Dry Runway: Model 737-8 (LEAP-1B25 Engine)

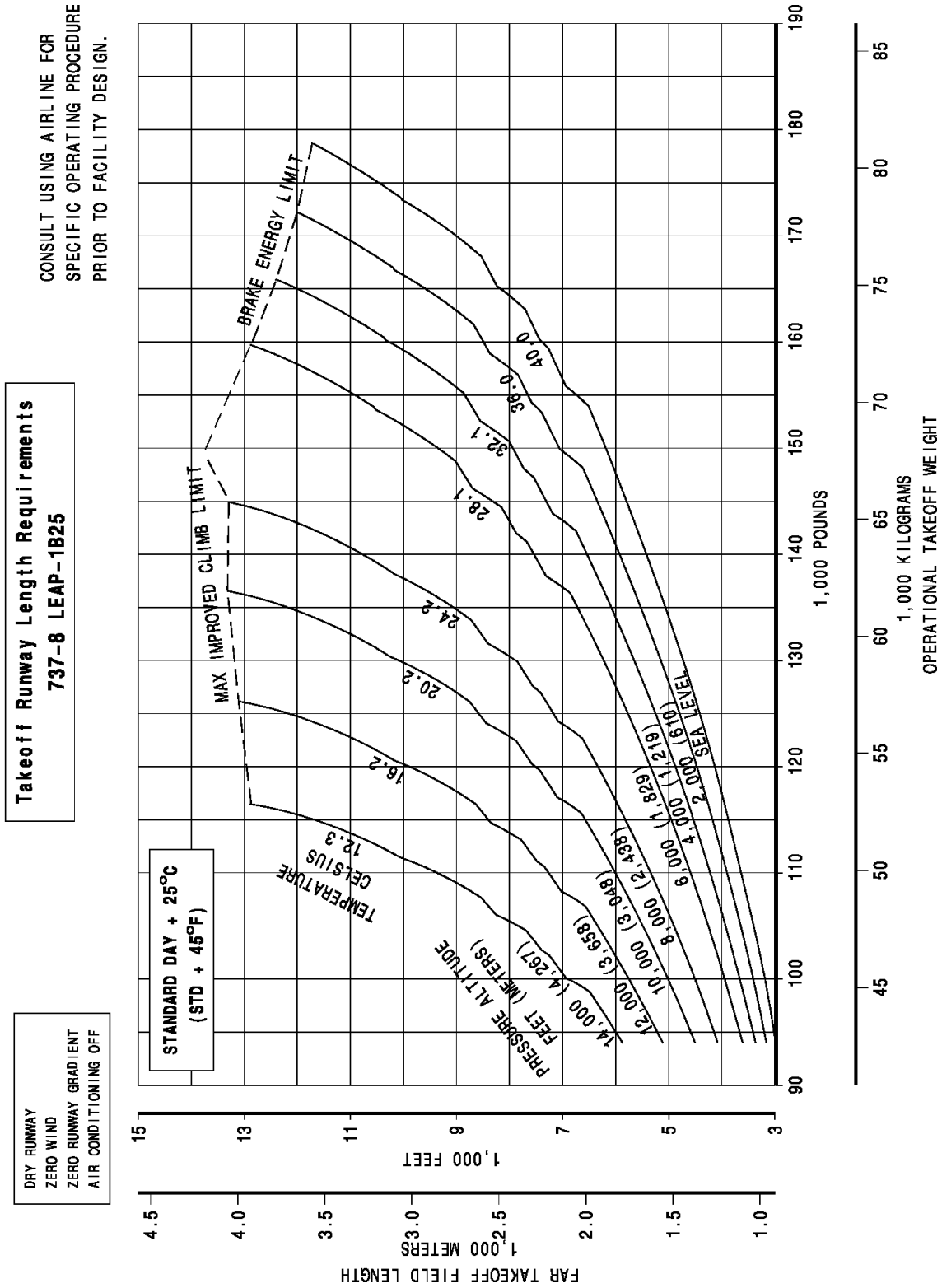

3.3.5 FAA/EASA Takeoff Runway Length Requirements - Standard Day + 63°F (STD + 35 °C), Dry Runway: Model 737-8 (LEAP-1B25 Engine)

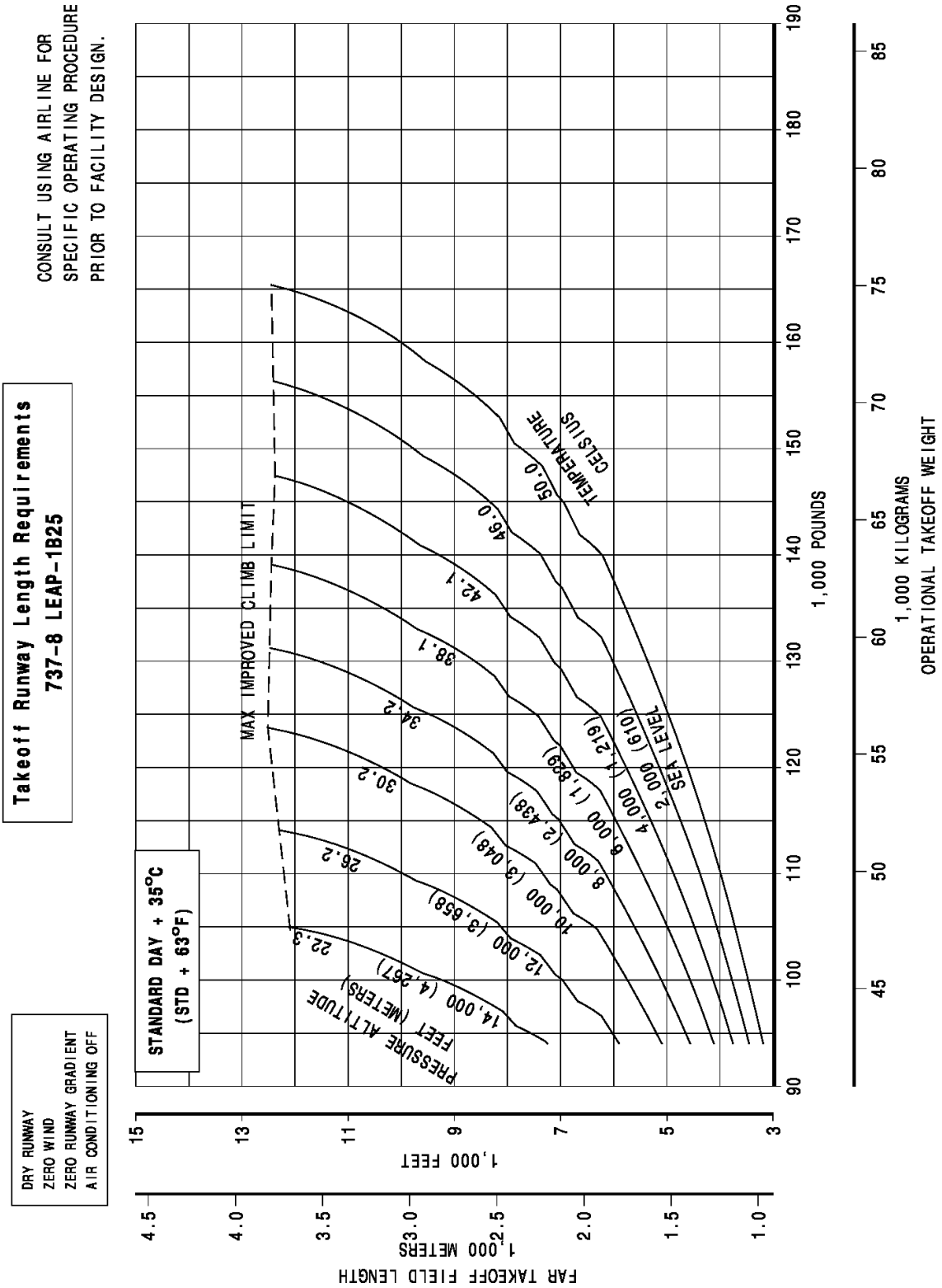

3.3.6 FAA/EASA Takeoff Runway Length Requirements - Standard Day, Dry Runway: Model 737-8 / BBJ MAX 8 (LEAP-1B28B1 / -1B28BBJ1 Engines)

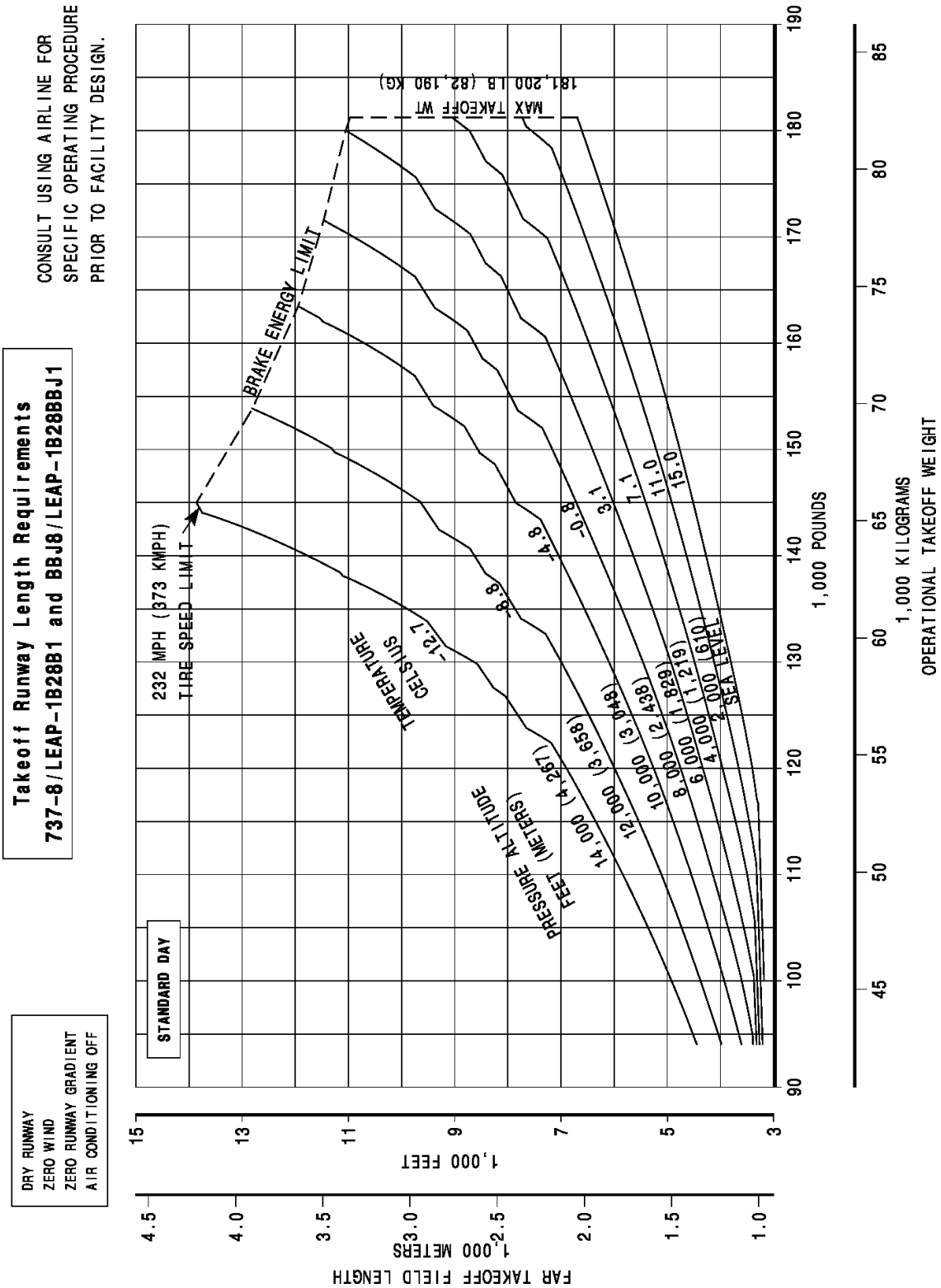

3.3.7 FAA/EASA Takeoff Runway Length Requirements - Standard Day + 27°F (STD + 15°C), Dry Runway: Model 737-8 / BBJ MAX 8 (LEAP-1B28B1 / -1B28BBJ1 Engines)

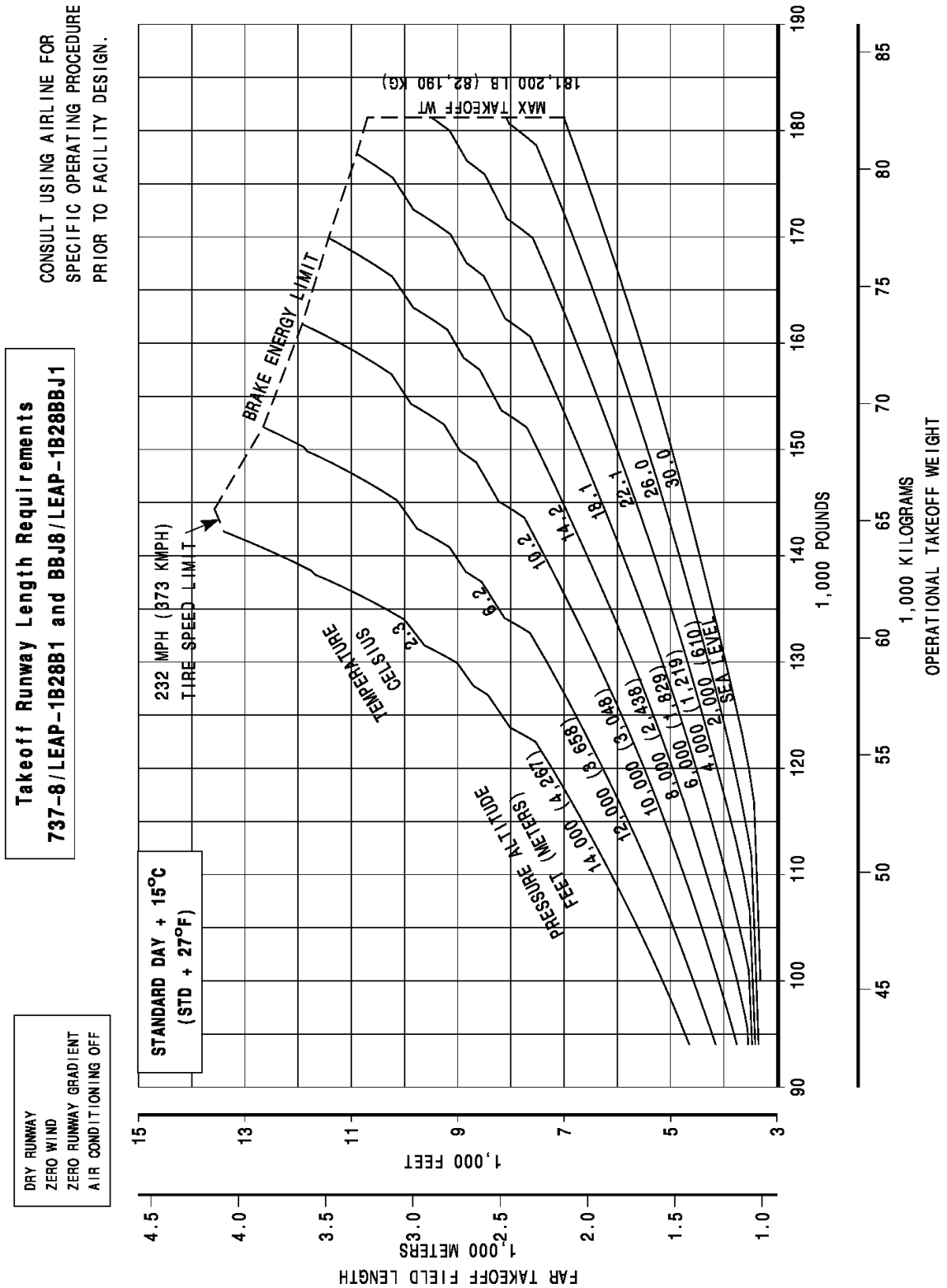

3.3.8 FAA/EASA Takeoff Runway Length Requirements - Standard Day + 45°F (STD + 25°C), Dry Runway: Model 737-8 / BBJ MAX 8 (LEAP-1B28B1 / -1B28BBJ1 Engines)

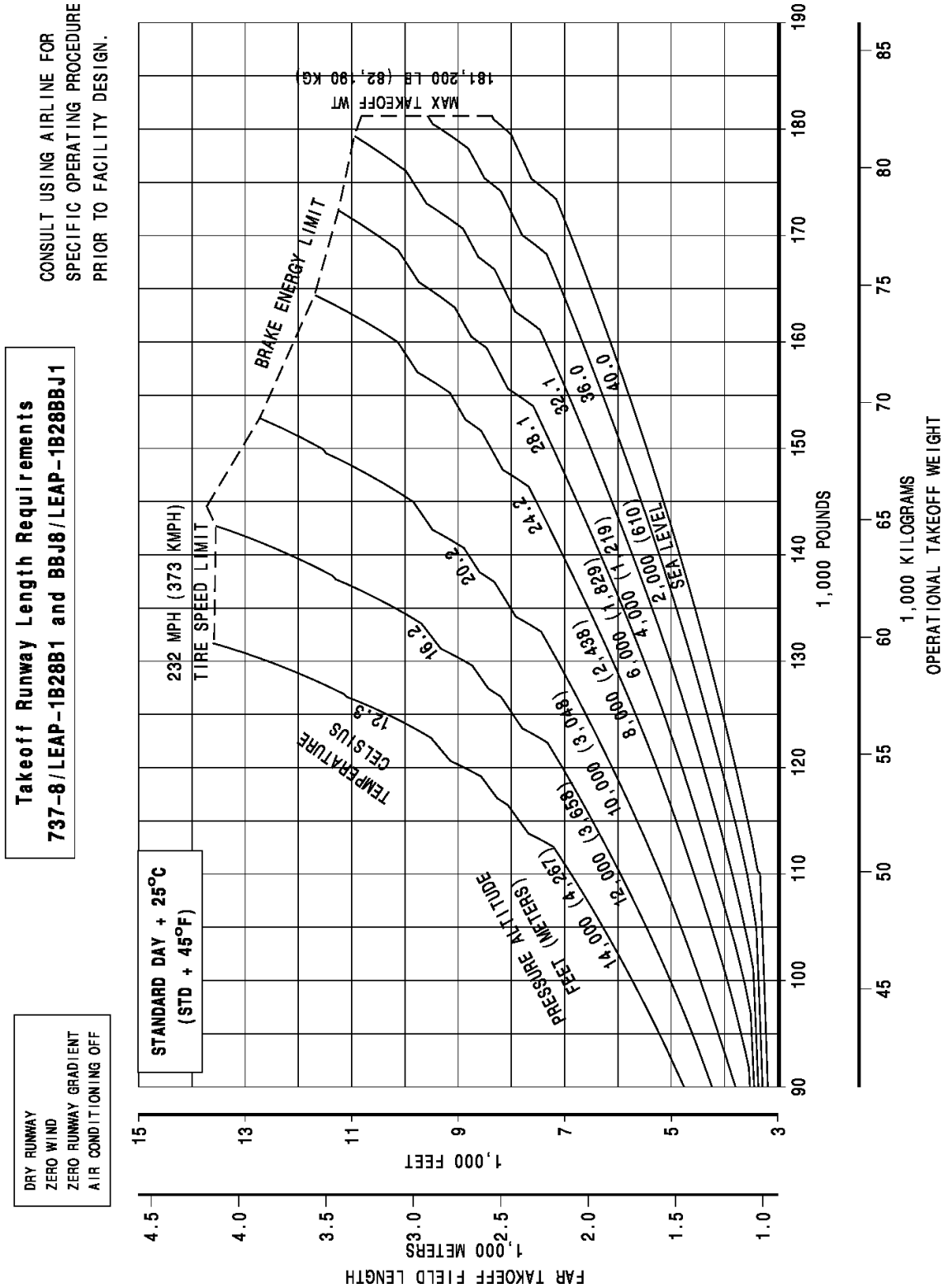

3.3.9 FAA/EASA Takeoff Runway Length Requirements - Standard Day + 63°F (STD + 35 °C), Dry Runway: Model 737-8 / BBJ MAX 8 (LEAP-1B28B1 / -1B28BBJ1 Engines)

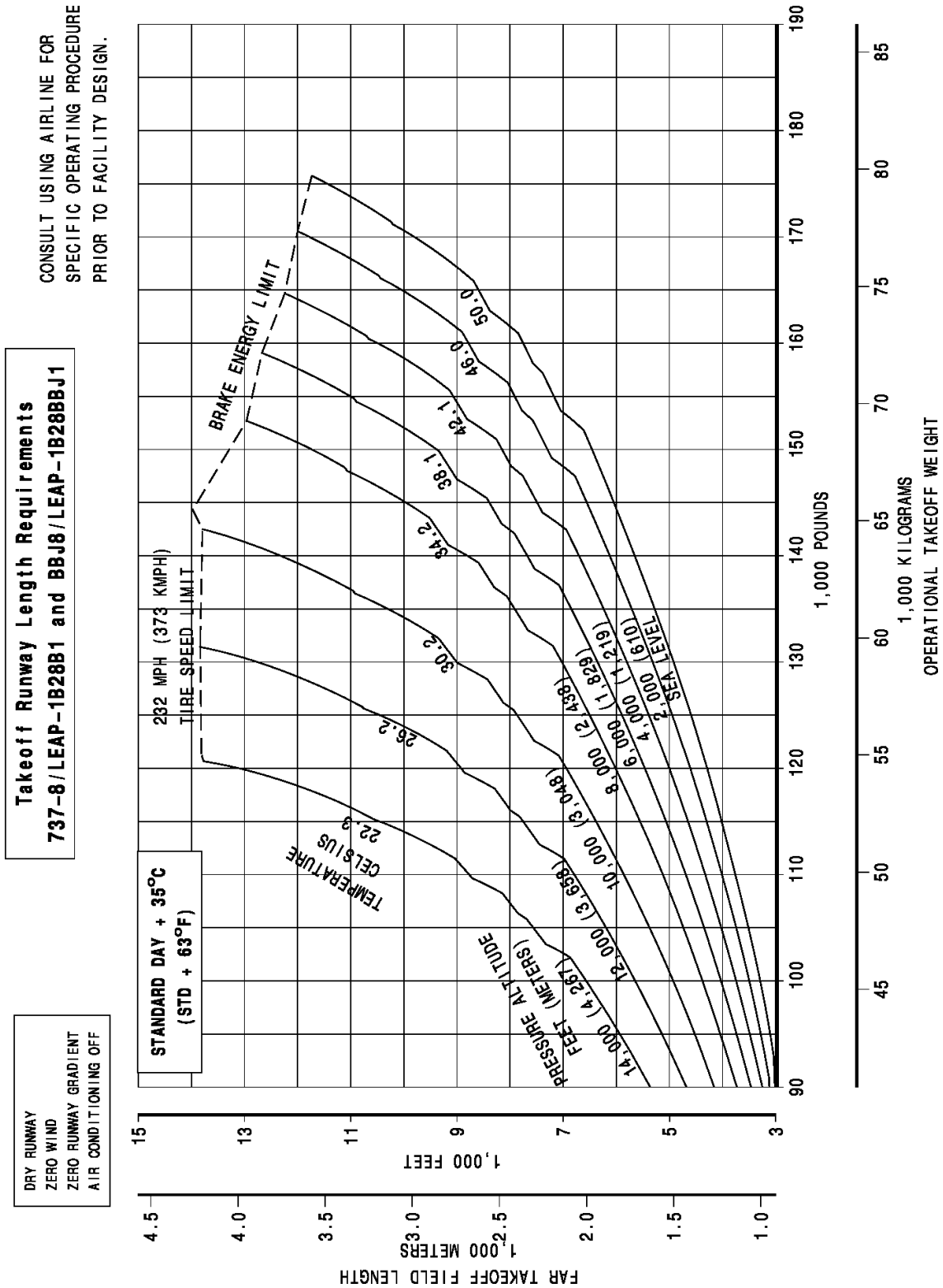

3.3.10 FAA/EASA Takeoff Runway Length Requirements - Standard Day, Dry Runway: Model 737-9 (LEAP-1B27 Engine)

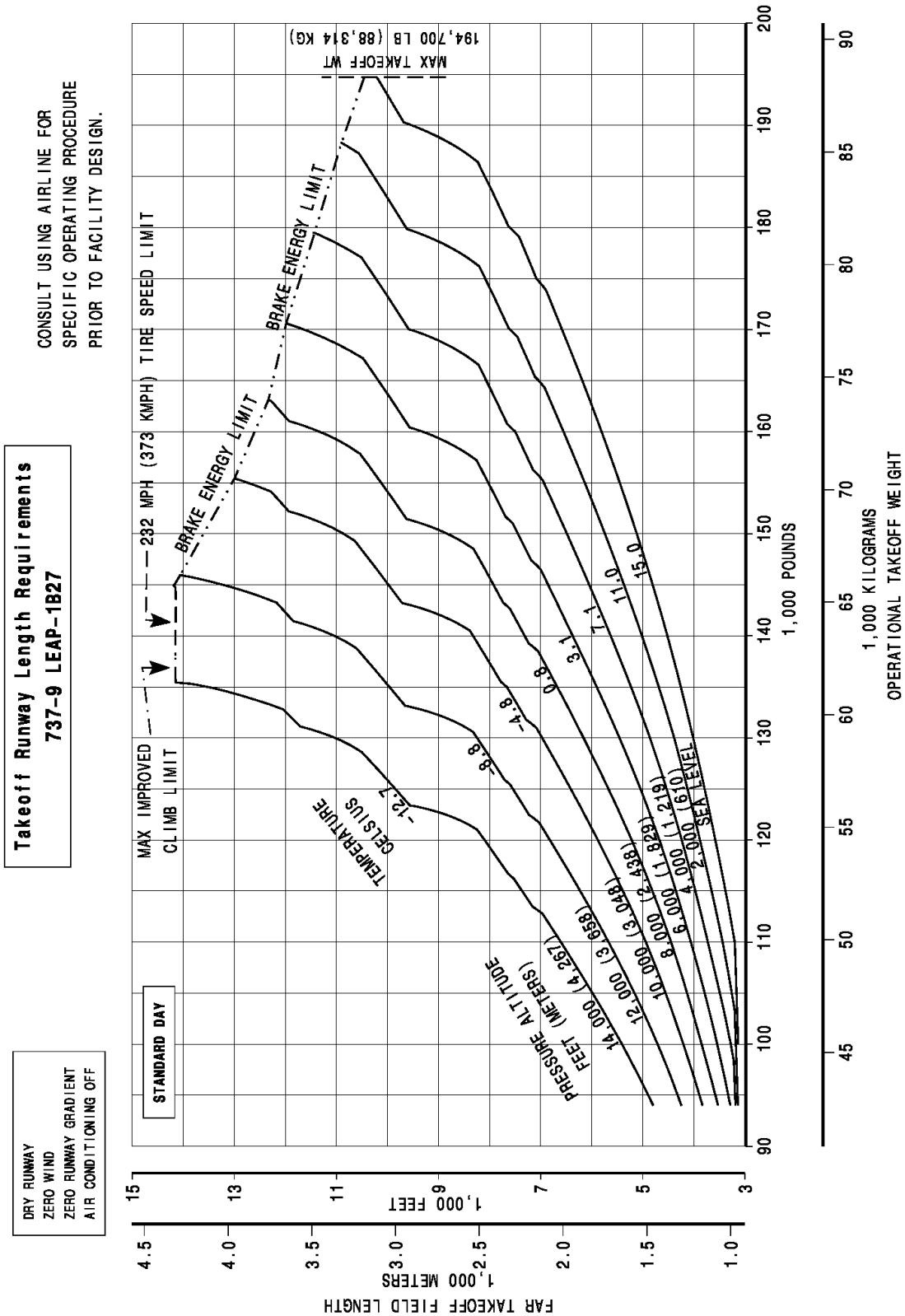

3.3.11 FAA/EASA Takeoff Runway Length Requirements - Standard Day + 27°F (STD + 15°C), Dry Runway: Model 737-9 (LEAP-1B27 Engine)

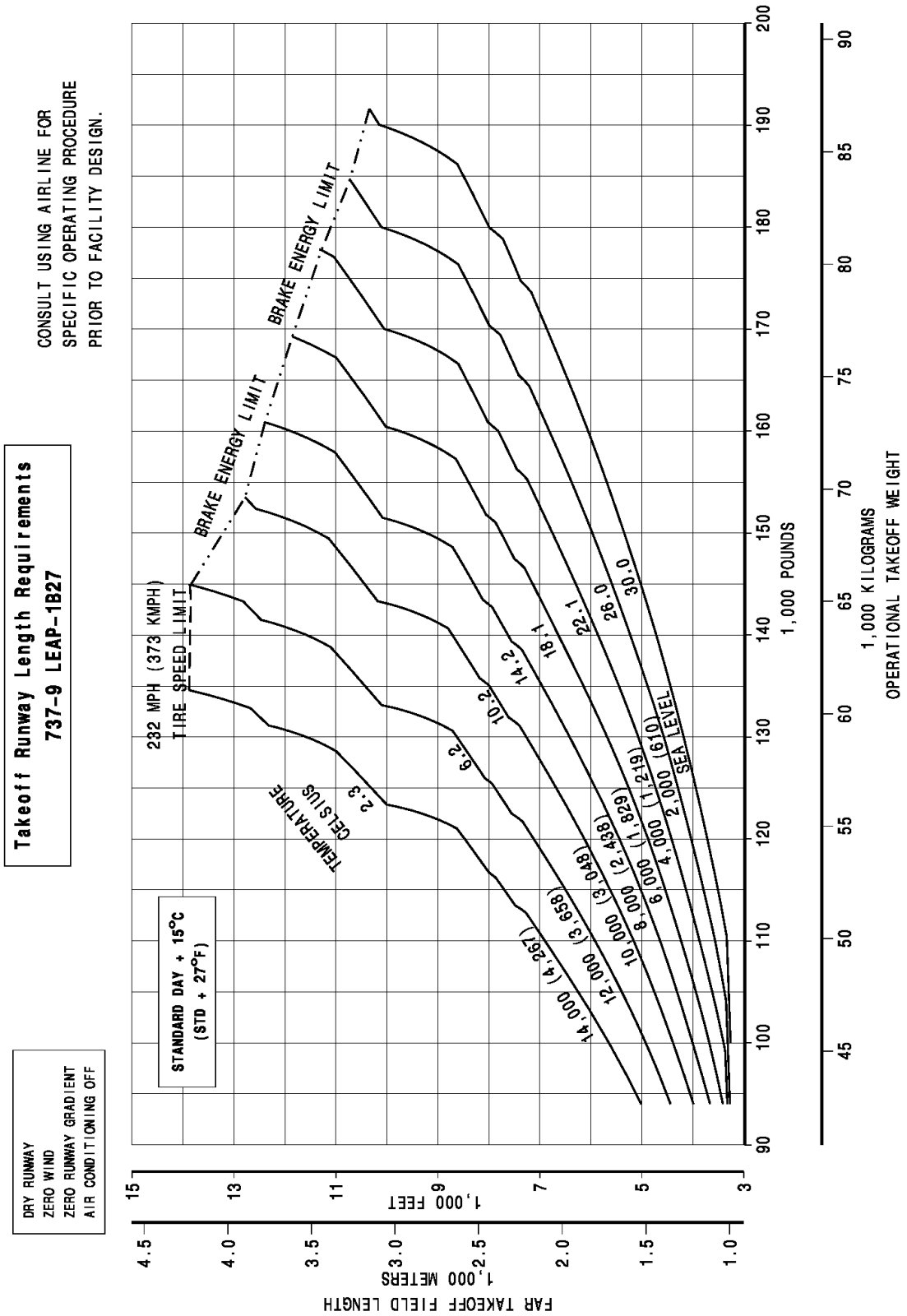

3.3.12 FAA/EASA Takeoff Runway Length Requirements - Standard Day + 45°F (STD + 25°C), Dry Runway: Model 737-9 (LEAP-1B27 Engine)

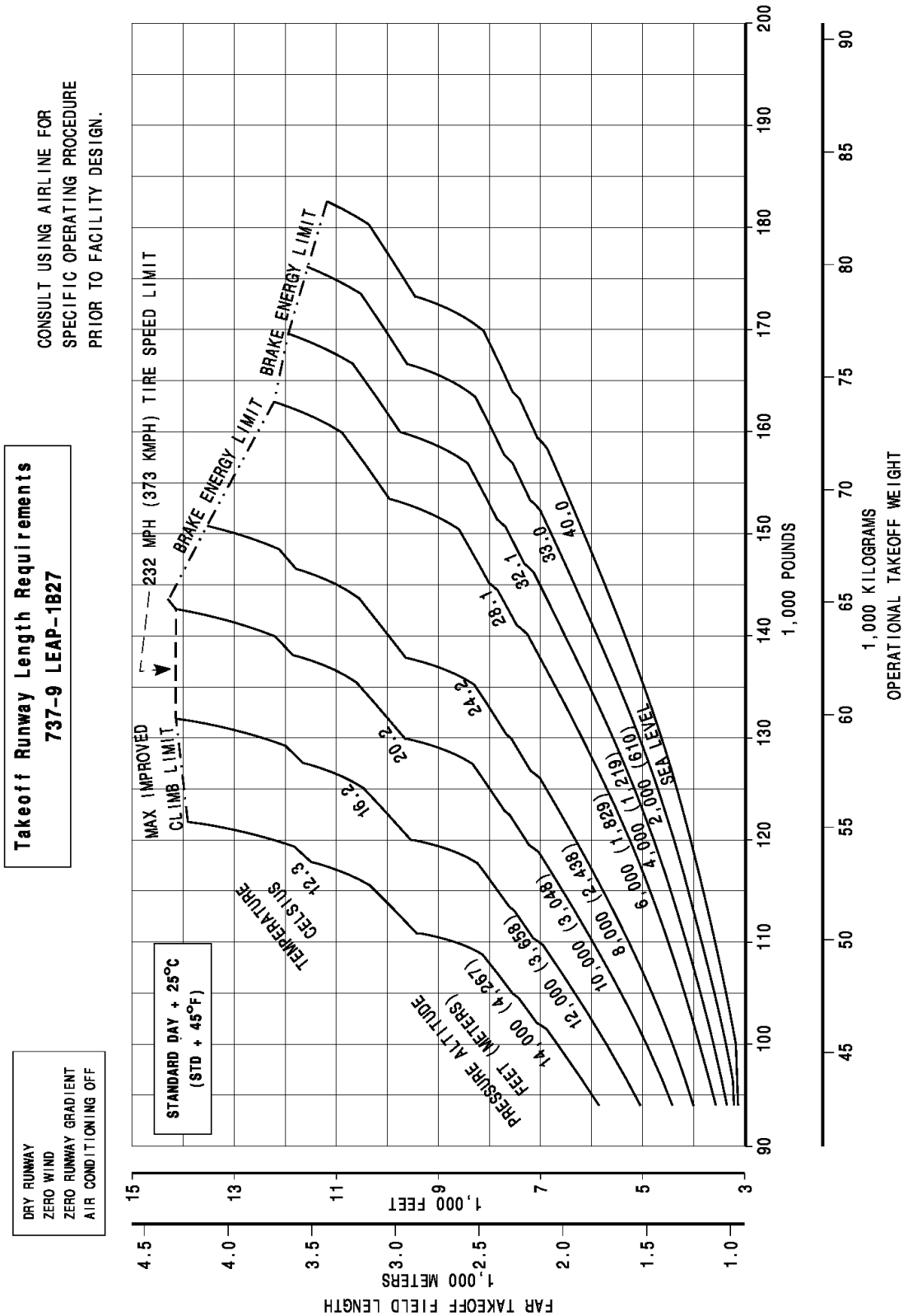

3.3.13 FAA/EASA Takeoff Runway Length Requirements - Standard Day + 63°F (STD + 35 °C), Dry Runway: Model 737-9 (LEAP-1B27 Engine)

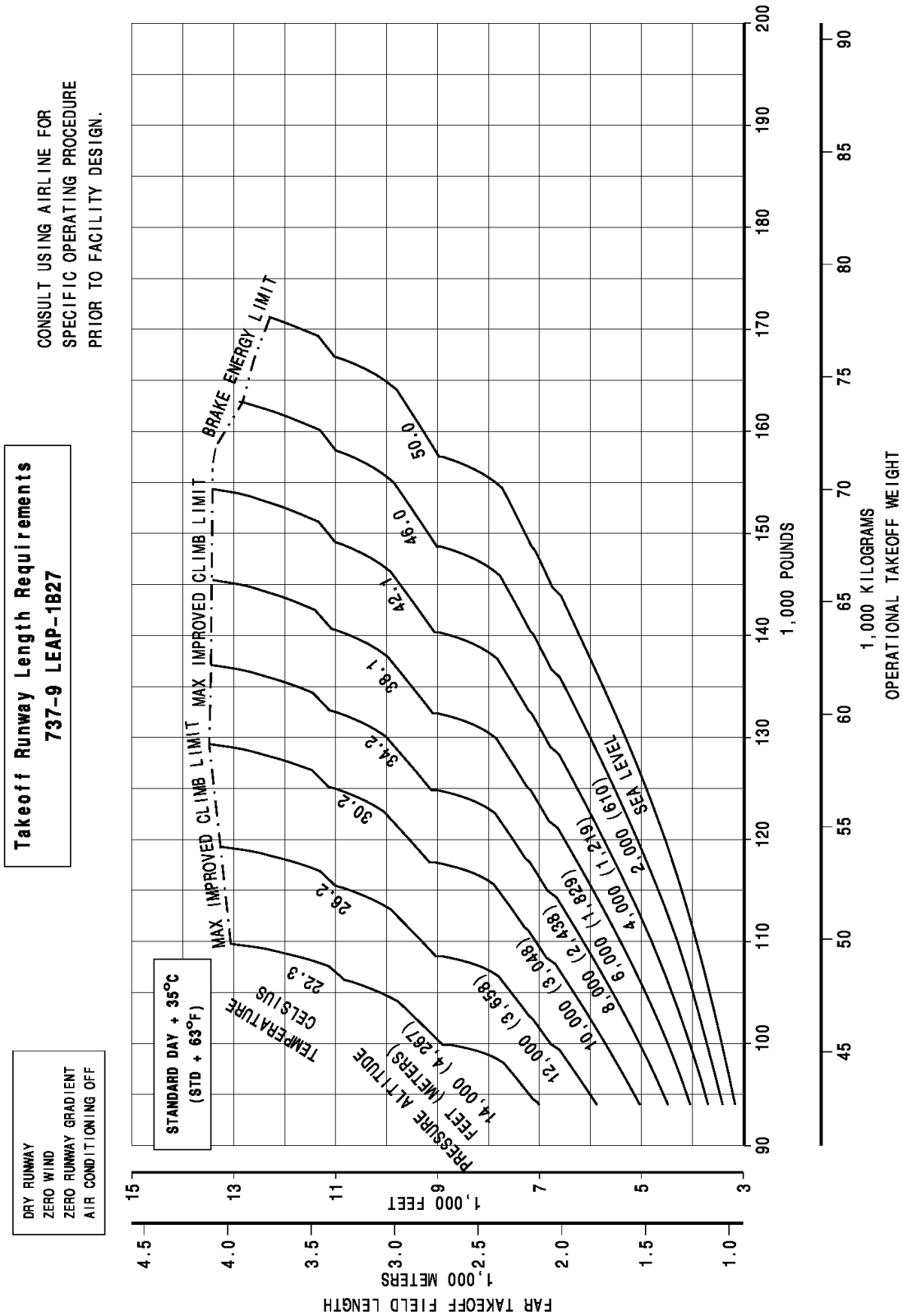

3.3.14 FAA/EASA Takeoff Runway Length Requirements - Standard Day, Dry Runway: Model 737-9 (LEAP-1B28 Engine)

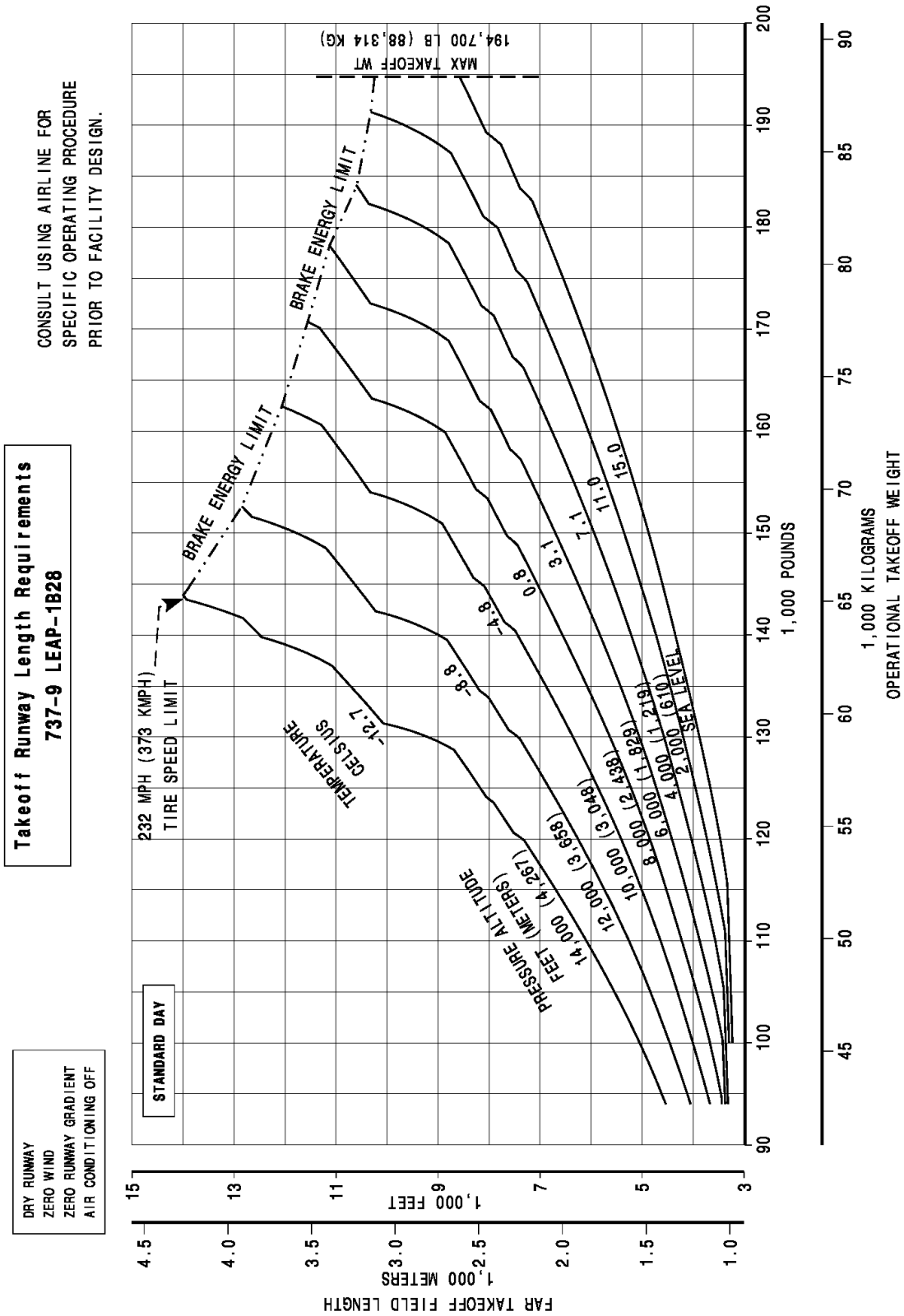

3.3.15 FAA/EASA Takeoff Runway Length Requirements - Standard Day + 27°F (STD + 15°C), Dry Runway: Model 737-9 (LEAP-1B28 Engine)

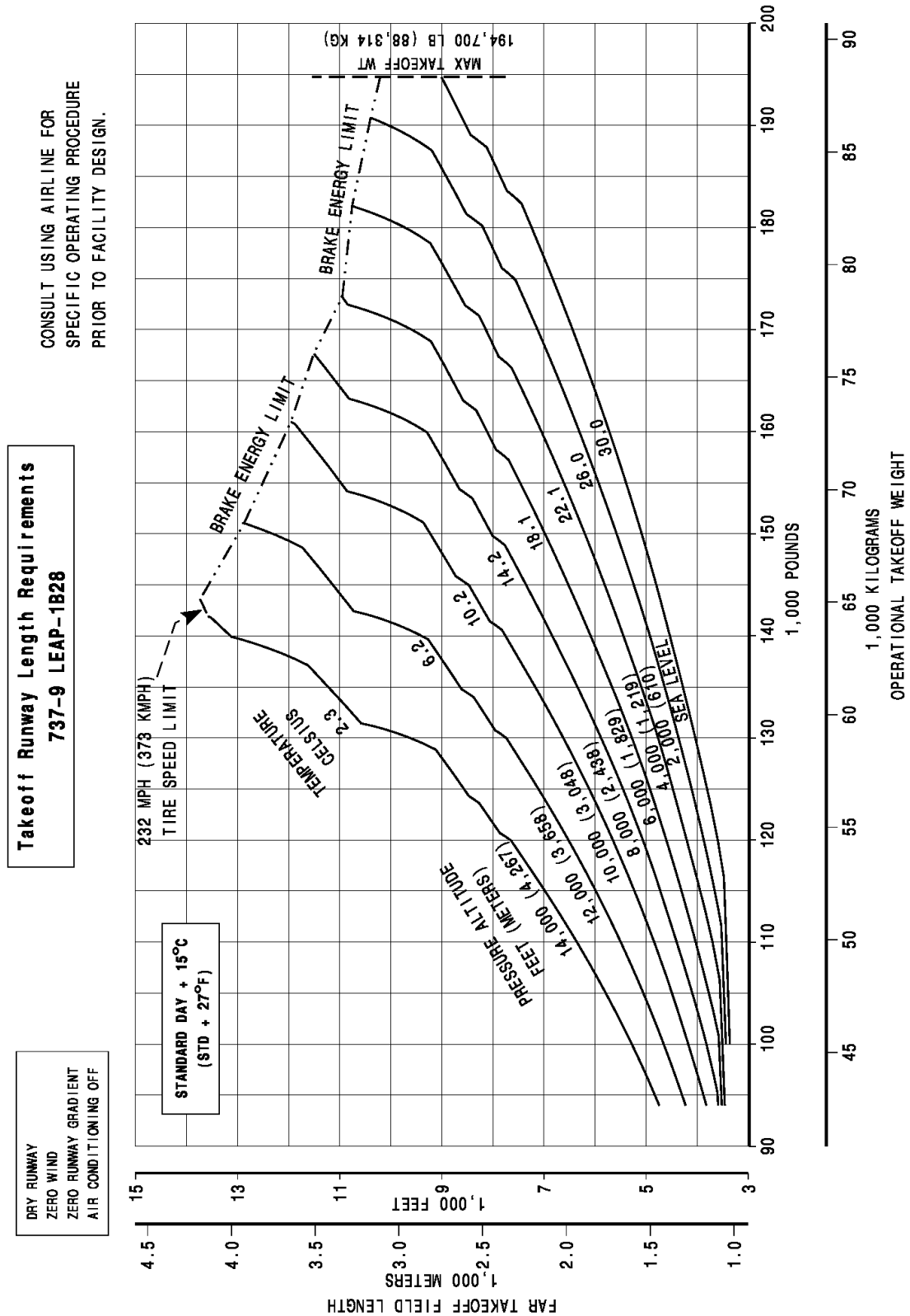

3.3.16 FAA/EASA Takeoff Runway Length Requirements - Standard Day + 45°F (STD + 25°C), Dry Runway: Model 737-9 (LEAP-1B28 Engine)

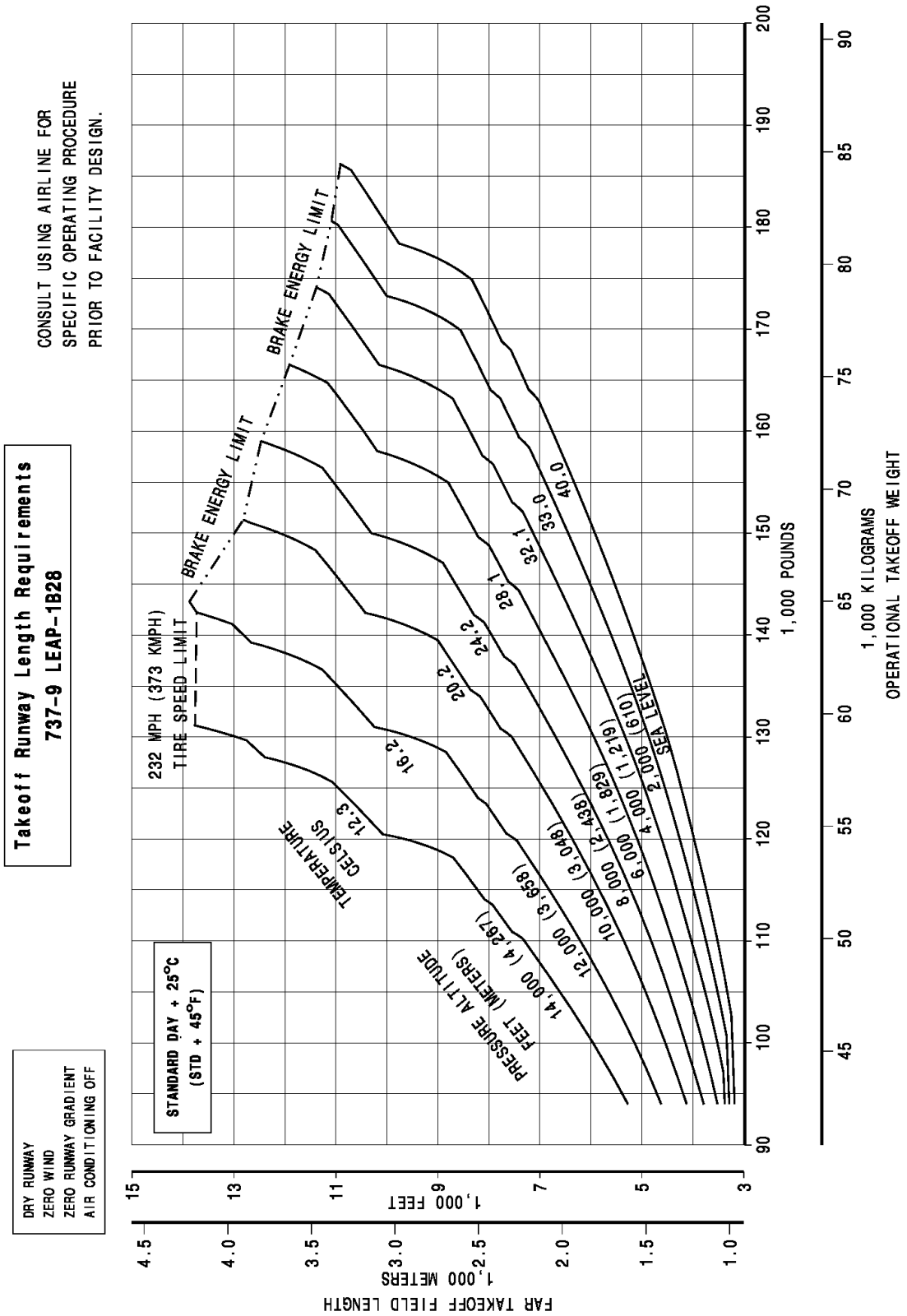

3.3.17 FAA/EASA Takeoff Runway Length Requirements - Standard Day + 63°F (STD + 35 °C), Dry Runway: Model 737-9 (LEAP-1B28 Engine)

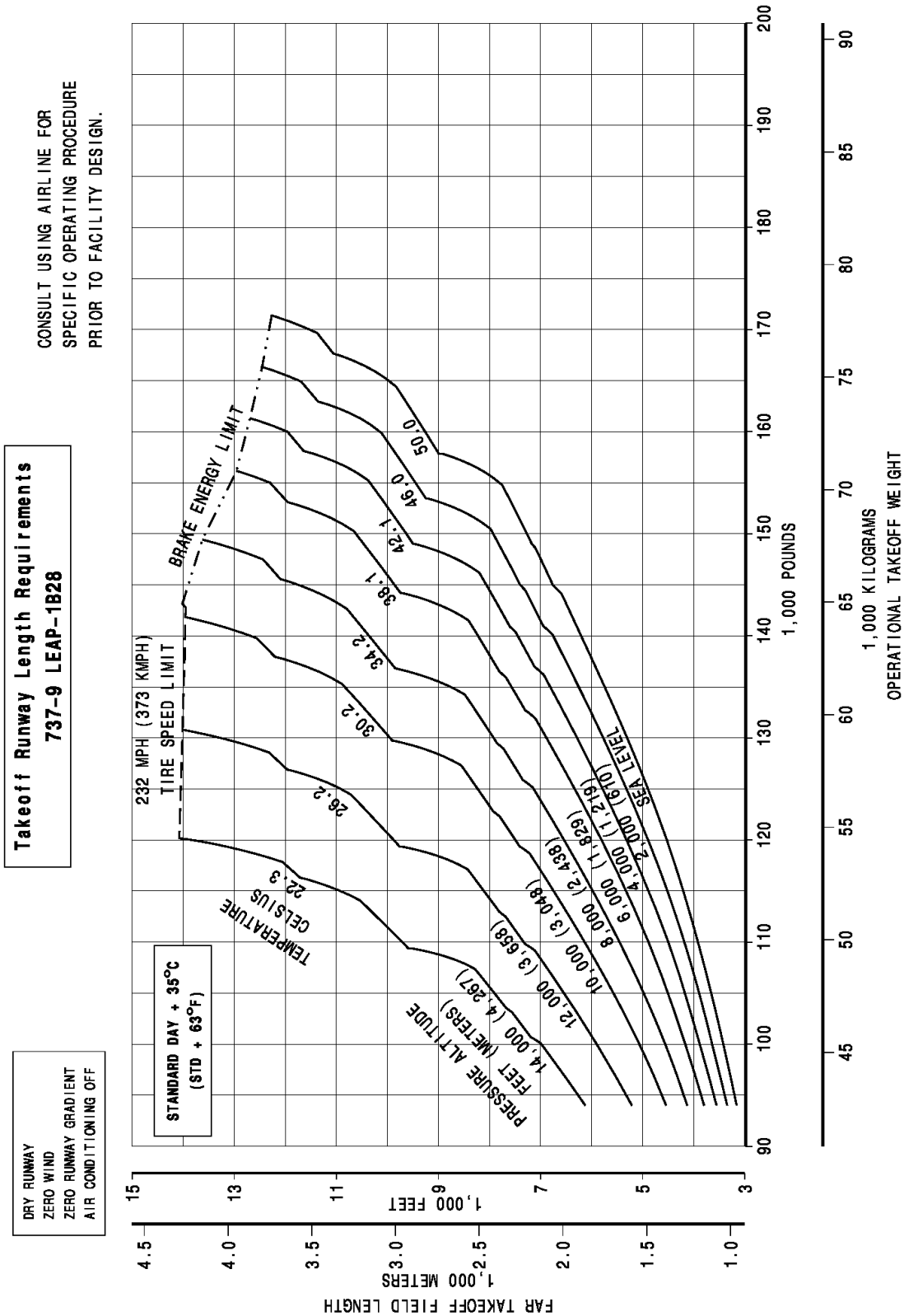

3.4 FAA/EASA LANDING RUNWAY LENGTH REQUIREMENTS

3.4.1 FAA/EASA Landing Runway Length Requirements: Model 737-7 / -8-200

DATA TO BE PROVIDED
AT A LATER DATE

3.4.2 FAA/EASA Landing Runway Length Requirements - Flaps 15: Model 737-8 / BBJ MAX 8

**Landing Field Length
737-8 (LEAP-1B Series)**

- STANDARD DAY, ZERO WIND
- AUTO SPOILERS OPERATIVE
- ANTI-SKID OPERATIVE
- ZERO RUNWAY GRADIENT
- CONSULT USING AIRLINE FOR SPECIFIC OPERATING PROCEDURE PRIOR TO FACILITY DESIGN

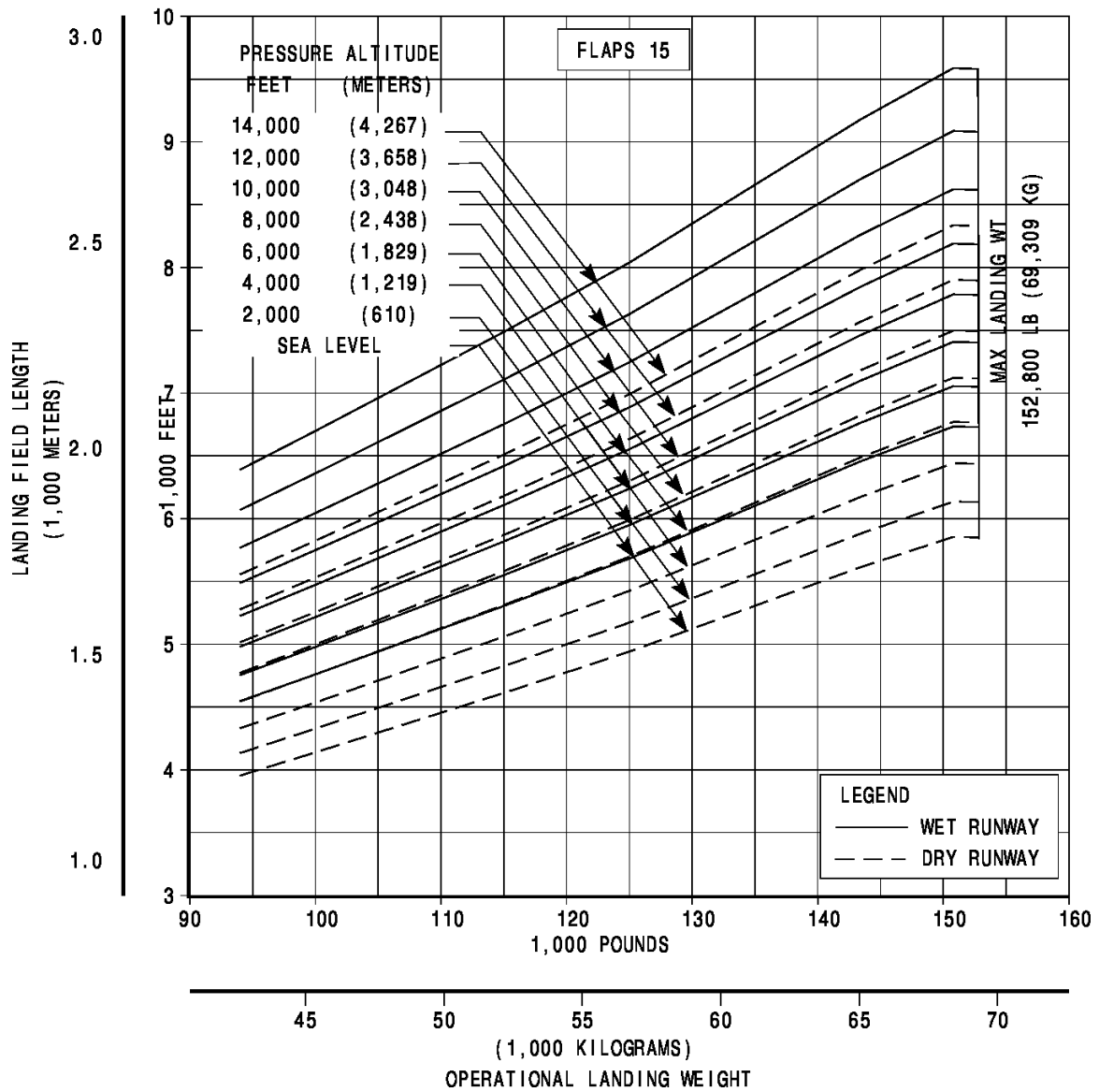

3.4.3 FAA/EASA Landing Runway Length Requirements - Flaps 30: Model 737-8 / BBJ MAX 8

**Landing Field Length
737-8 (LEAP-1B Series)**

- STANDARD DAY, ZERO WIND
- AUTO SPOILERS OPERATIVE
- ANTI-SKID OPERATIVE
- ZERO RUNWAY GRADIENT
- CONSULT USING AIRLINE FOR SPECIFIC OPERATING PROCEDURE PRIOR TO FACILITY DESIGN

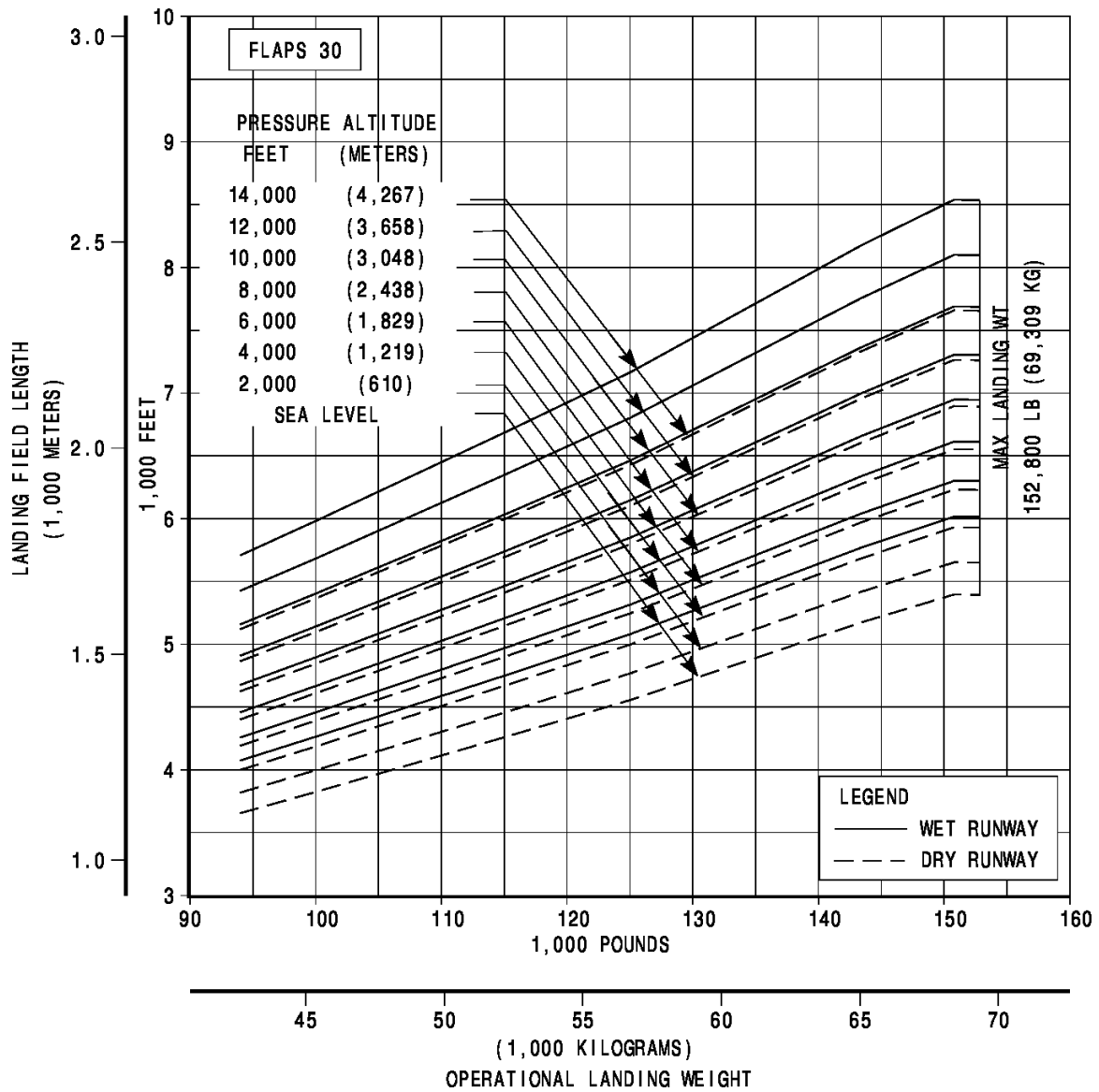

3.4.4 FAA/EASA Landing Runway Length Requirements - Flaps 40: Model 737-8 / BBJ MAX 8

**Landing Field Length
737-8 (LEAP-1B Series)**

- STANDARD DAY, ZERO WIND
- AUTO SPOILERS OPERATIVE
- ANTI-SKID OPERATIVE
- ZERO RUNWAY GRADIENT
- CONSULT USING AIRLINE FOR SPECIFIC OPERATING PROCEDURE PRIOR TO FACILITY DESIGN

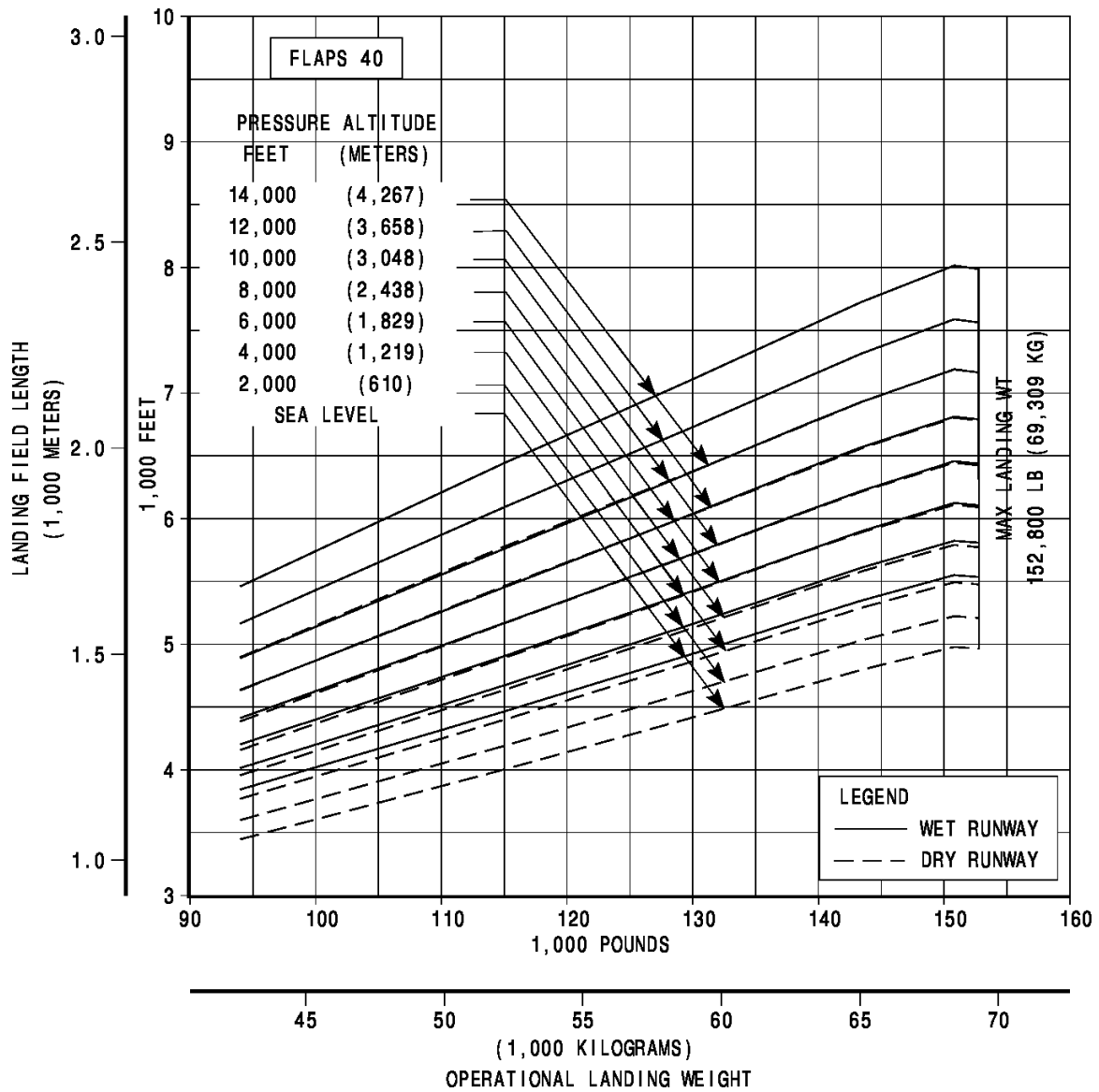

3.4.5 FAA/EASA Landing Runway Length Requirements - Flaps 15: Model 737-9

**Landing Field Length Requirements
737-9 (LEAP-1B Series)**

- STANDARD DAY, ZERO WIND
- AUTO SPOILERS OPERATIVE
- ANTI-SKID OPERATIVE
- ZERO RUNWAY GRADIENT
- CONSULT USING AIRLINE FOR SPECIFIC OPERATING PROCEDURE PRIOR TO FACILITY DESIGN

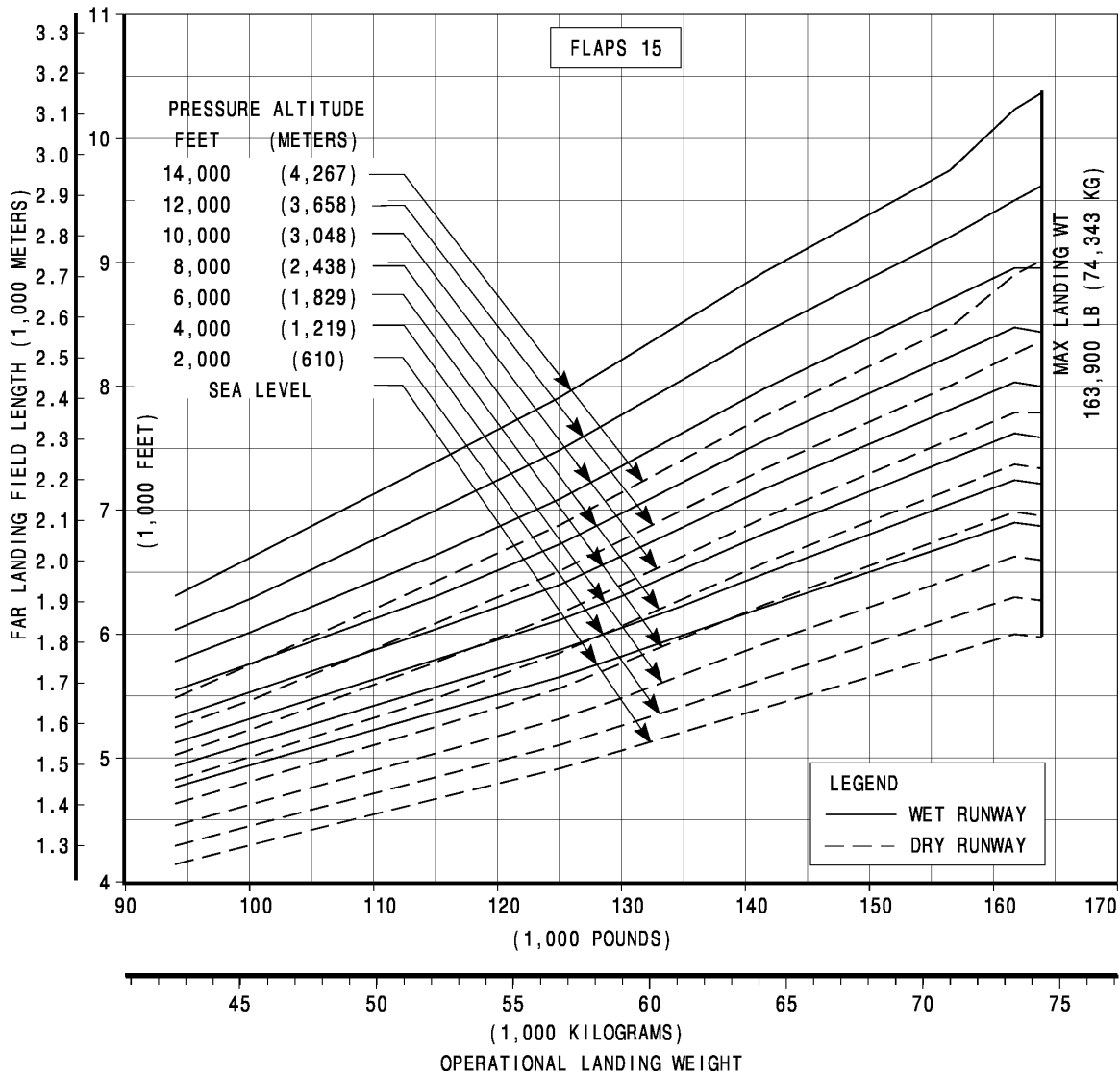

3.4.6 FAA/EASA Landing Runway Length Requirements - Flaps 30: Model 737-9

**Landing Field Length Requirements
737-9 (LEAP-1B Series)**

- STANDARD DAY, ZERO WIND
- AUTO SPOILERS OPERATIVE
- ANTI-SKID OPERATIVE
- ZERO RUNWAY GRADIENT
- CONSULT USING AIRLINE FOR SPECIFIC OPERATING PROCEDURE PRIOR TO FACILITY DESIGN

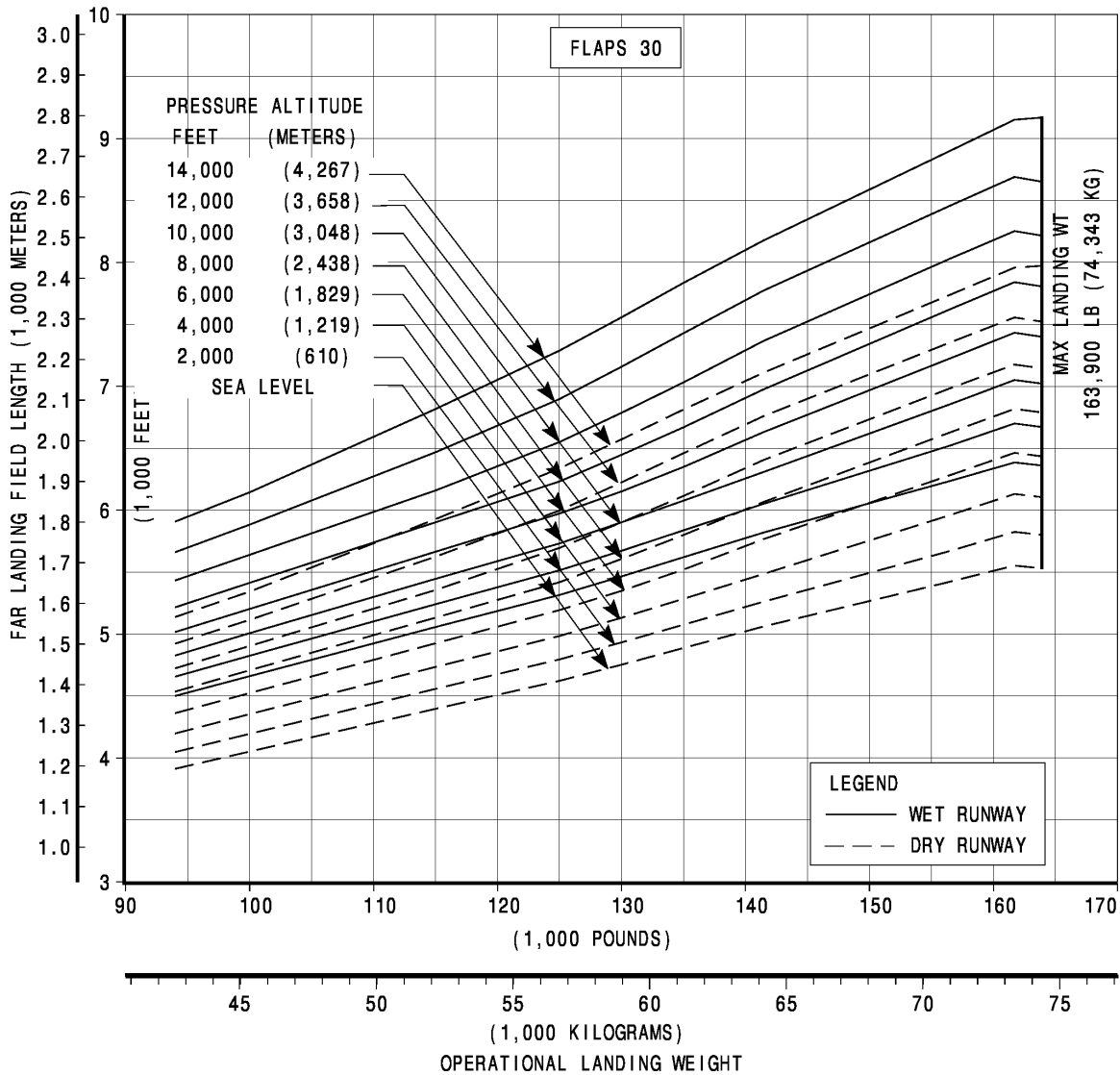

3.4.7 FAA/EASA Landing Runway Length Requirements - Flaps 40: Model 737-9

**Landing Field Length Requirements
737-9 (LEAP-1B Series)**

- STANDARD DAY, ZERO WIND
- AUTO SPOILERS OPERATIVE
- ANTI-SKID OPERATIVE
- ZERO RUNWAY GRADIENT
- CONSULT USING AIRLINE FOR SPECIFIC OPERATING PROCEDURE PRIOR TO FACILITY DESIGN

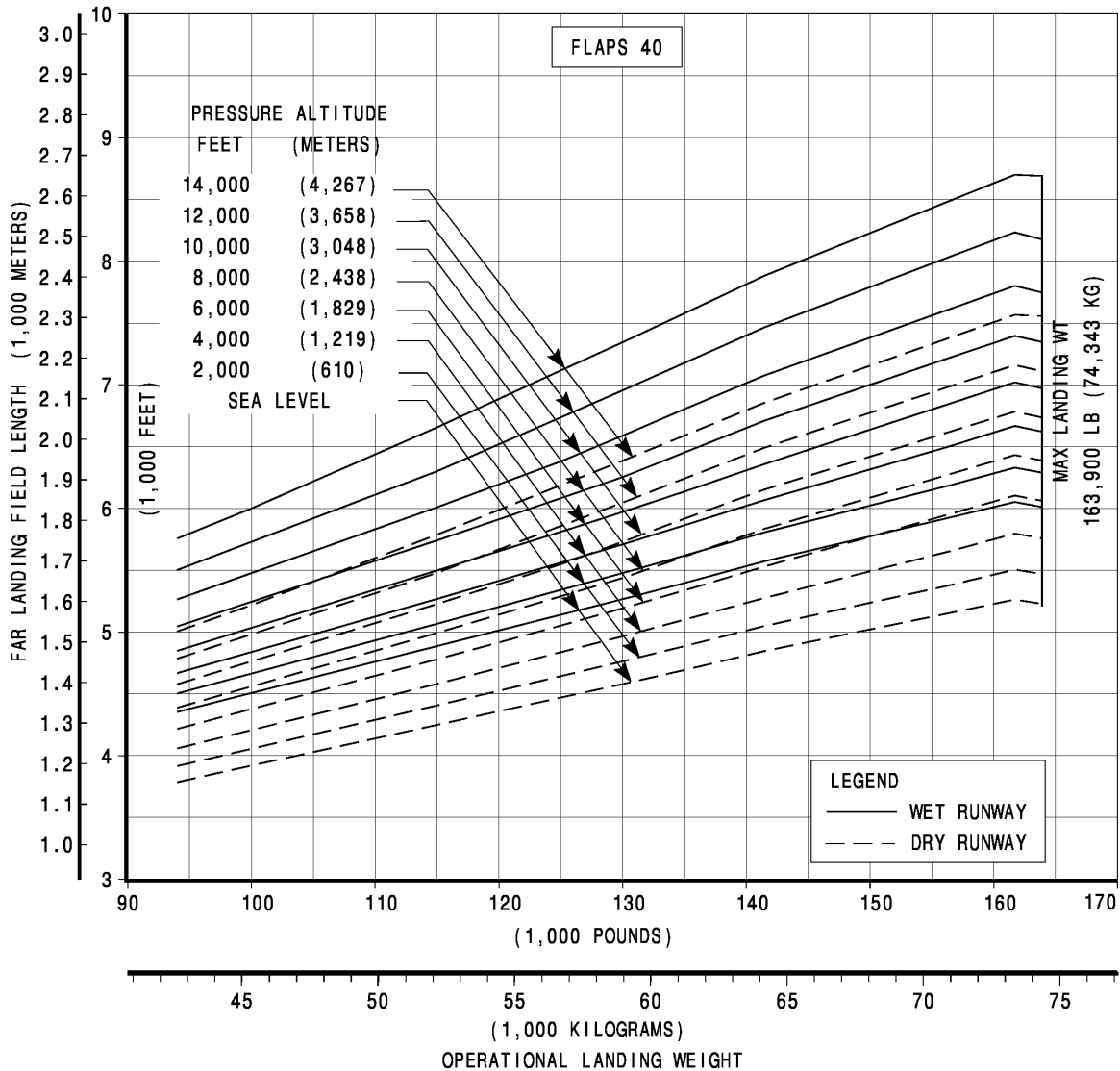

4.0 GROUND MANEUVERING

4.1 GENERAL INFORMATION

This section provides airplane turning capability and maneuvering characteristics.

For ease of presentation, these data have been determined from the theoretical limits imposed by the geometry of the aircraft, and where noted, provide for a normal allowance for tire slippage. As such, they reflect the turning capability of the aircraft in favorable operating circumstances. These data should be used only as guidelines for the method of determination of such parameters and for the maneuvering characteristics of this aircraft.

In the ground operating mode, varying airline practices may demand that more conservative turning procedures be adopted to avoid excessive tire wear and reduce possible maintenance problems. Airline operating procedures will vary in the level of performance over a wide range of operating circumstances throughout the world. Variations from standard aircraft operating patterns may be necessary to satisfy physical constraints within the maneuvering area, such as adverse grades, limited area, or high risk of jet blast damage. For these reasons, ground maneuvering requirements should be coordinated with the using airlines prior to layout planning.

Section 4.2 presents turning radii for various nose gear steering angles. Radii for the main and nose gears are measured from the turn center to the outside of the tire.

Section 4.3 shows data on minimum width of pavement required for 180° turn.

Section 4.4 provides pilot visibility data from the cockpit and the limits of ambinocular vision through the windows. Ambinocular vision is defined as the total field of vision seen simultaneously by both eyes.

Section 4.5 shows approximate wheel paths for various runway and taxiway turn scenarios on a 100 ft (30 m) runway and 50 ft (15 m) taxiway system. Boeing 737 MAX aircraft are capable of operating on 100 ft wide runways. However, for design purposes, the FAA and ICAO recommend that the minimum runway width for the 737 MAX aircraft is 150 ft (45 m).

The pavement fillet geometries are based on the FAA's Advisory Circular (AC) 150/5300-13 (thru change 16). They represent typical fillet geometries built at many airports worldwide. ICAO and other civil aviation authorities publish many different fillet design methods. Prior to determining the size of fillets, airports are advised to check with the airlines regarding the operating procedures and aircraft types they expect to use at the airport. Further, given the cost of modifying fillets and the operational impact to ground movement and air traffic during construction, airports may want to design critical fillets for larger aircraft types to minimize future operational impacts.

Section 4.6 illustrates a typical runway holding bay configuration.

4.2 TURNING RADII

4.2.1 Turning Radii – No Slip Angle: Model 737-7

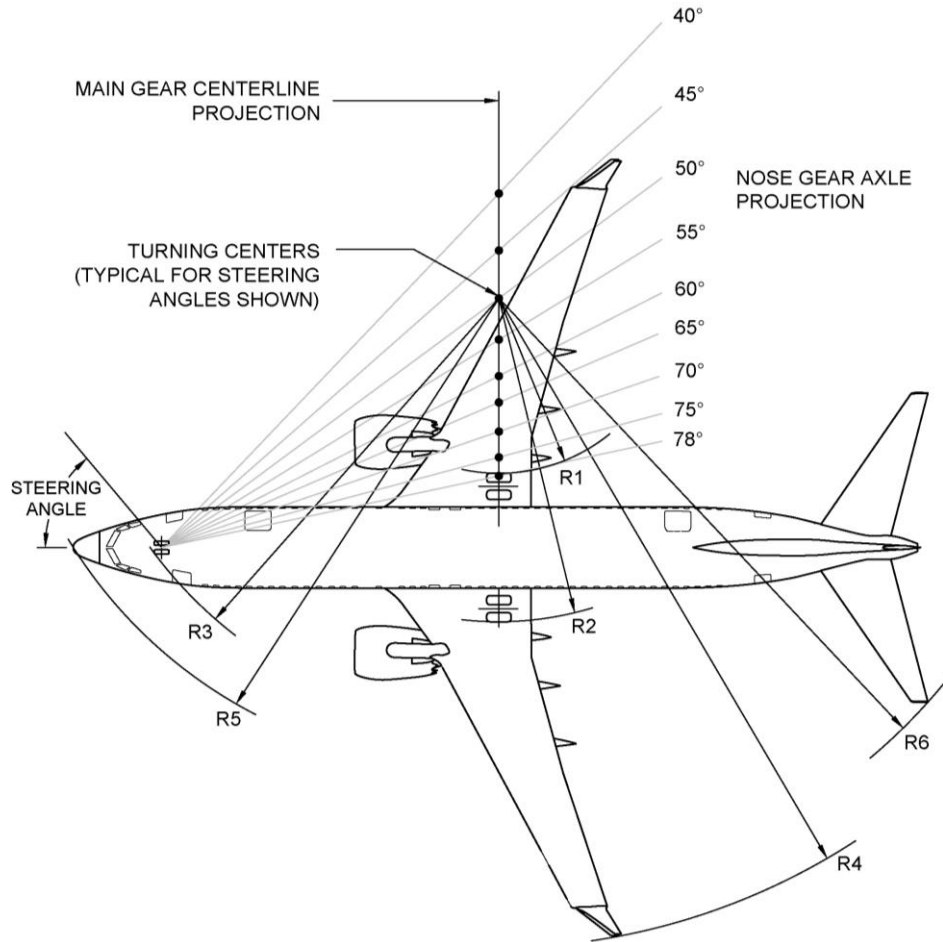

STEERING ANGLE (DEGREES)	R1		R2		R3		R4		R5		R6	
	INNER GEAR		OUTER GEAR		NOSE GEAR		WING TIP		NOSE		TAIL	
	FT	M	FT	M	FT	M	FT	M	FT	M	FT	M
30	65	19.8	88	26.8	89	27.1	137	41.8	96	29.3	116	35.4
35	52	15.8	75	22.9	78	23.8	123	37.5	85	25.9	105	32.0
40	41	12.5	64	19.5	70	21.3	113	34.4	78	23.8	97	29.6
45	33	10.1	56	17.1	63	19.2	105	32.0	73	22.3	90	27.4
50	26	7.9	49	14.9	59	18.0	98	29.9	69	21.0	85	25.9
55	20	6.1	43	13.1	55	16.8	92	28.0	65	19.8	81	24.7
60	14	4.3	37	11.3	52	15.8	87	26.5	63	19.2	77	23.5
65	9	2.7	32	9.8	50	15.2	82	25.0	61	18.6	74	22.6
70	5	1.5	28	8.5	48	14.6	78	23.8	60	18.3	72	21.9
75	1	0.3	24	7.3	47	14.3	74	22.6	59	18.0	70	21.3
78 (MAX)	-3	-0.9	21	6.4	46	14.0	71	21.6	59	18.0	68	20.7

4.2.2 Turning Radii – No Slip Angle: Model 737-8 / -8-200 / BBJ MAX 8

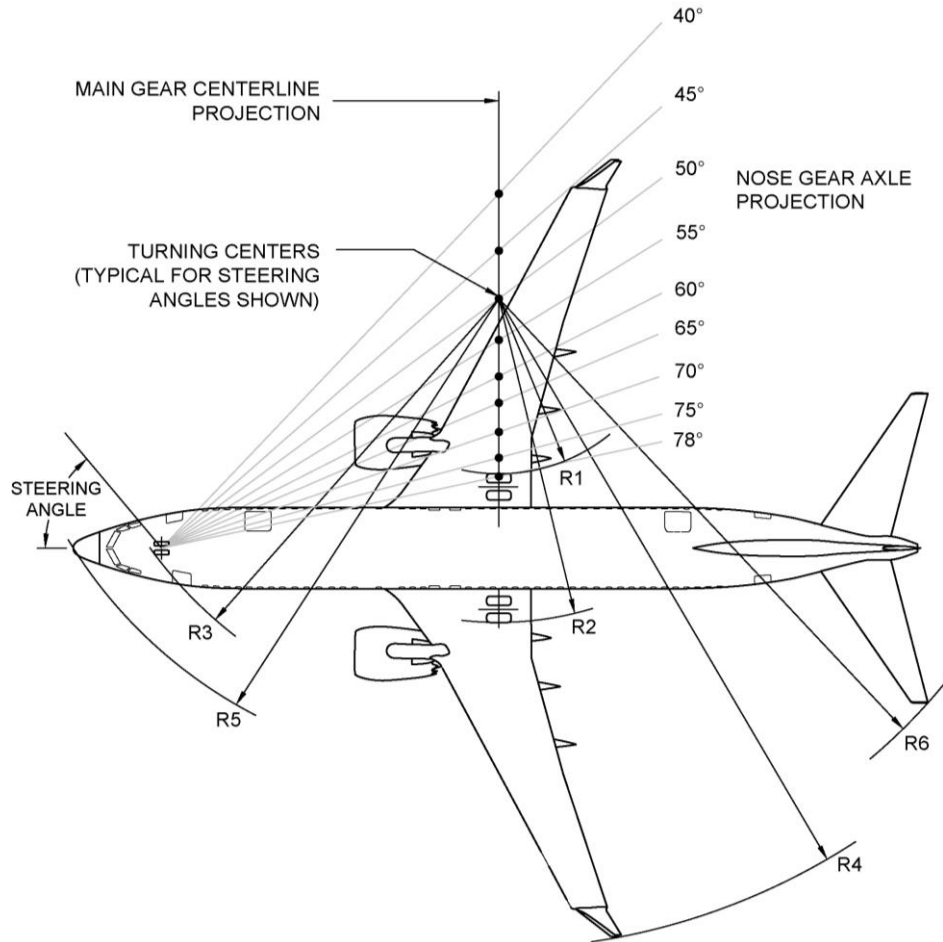

STEERING ANGLE (DEGREES)	R1		R2		R3		R4		R5		R6	
	INNER GEAR		OUTER GEAR		NOSE GEAR		WING TIP		NOSE		TAIL	
	FT	M	FT	M	FT	M	FT	M	FT	M	FT	M
30	78	23.8	101	30.8	104	31.7	149	45.4	110	33.5	130	39.6
35	62	18.9	85	25.9	91	27.7	134	40.8	98	29.9	117	35.7
40	50	15.2	73	22.3	81	24.7	122	37.2	89	27.1	107	32.6
45	40	12.2	63	19.2	74	22.6	112	34.1	83	25.3	99	30.2
50	32	9.8	55	16.8	68	20.7	104	31.7	78	23.8	93	28.3
55	25	7.6	48	14.6	64	19.5	97	29.6	74	22.6	88	26.8
60	19	5.8	42	12.8	61	18.6	91	27.7	72	21.9	84	25.6
65	13	4.0	36	11.0	58	17.7	85	25.9	69	21.0	81	24.7
70	8	2.4	31	9.4	56	17.1	80	24.4	68	20.7	78	23.8
75	3	0.9	26	7.9	54	16.5	75	22.9	67	20.4	75	22.9
78 (MAX)	-1	-0.3	23	7.0	54	16.5	73	22.3	66	20.1	74	22.6

4.2.3 Turning Radii – No Slip Angle: Model 737-9

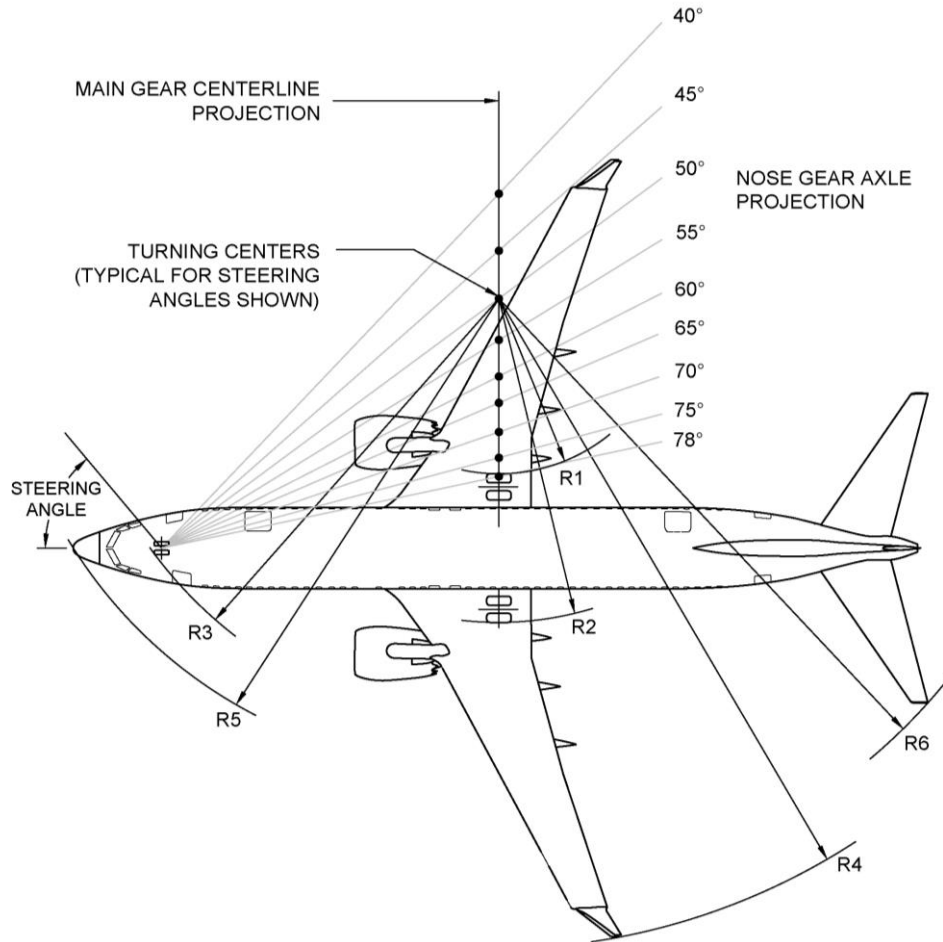

STEERING ANGLE (DEGREES)	R1		R2		R3		R4		R5		R6	
	INNER GEAR		OUTER GEAR		NOSE GEAR		WING TIP		NOSE		TAIL	
	FT	M	FT	M	FT	M	FT	M	FT	M	FT	M
30	87	26.5	110	33.5	114	34.7	158	48.2	120	36.6	140	42.7
35	69	21.0	92	28.0	100	30.5	141	43.0	107	32.6	125	38.1
40	56	17.1	79	24.1	89	27.1	128	39.0	97	29.6	114	34.7
45	45	13.7	68	20.7	81	24.7	117	35.7	90	27.4	106	32.3
50	36	11.0	59	18.0	75	22.9	108	32.9	85	25.9	99	30.2
55	28	8.5	51	15.5	70	21.3	101	30.8	81	24.7	93	28.3
60	22	6.7	45	13.7	67	20.4	94	28.7	77	23.5	89	27.1
65	15	4.6	38	11.6	64	19.5	88	26.8	75	22.9	85	25.9
70	10	3.0	32	9.8	61	18.6	82	25.0	73	22.3	82	25.0
75	4	1.2	27	8.2	60	18.3	77	23.5	72	21.9	79	24.1
78 (MAX)	1	0.3	24	7.3	59	18.0	74	22.6	71	21.6	78	23.8

4.3 CLEARANCE RADII

4.3.1 Clearance Radii – 3° and 5° Slip Angles: All Models

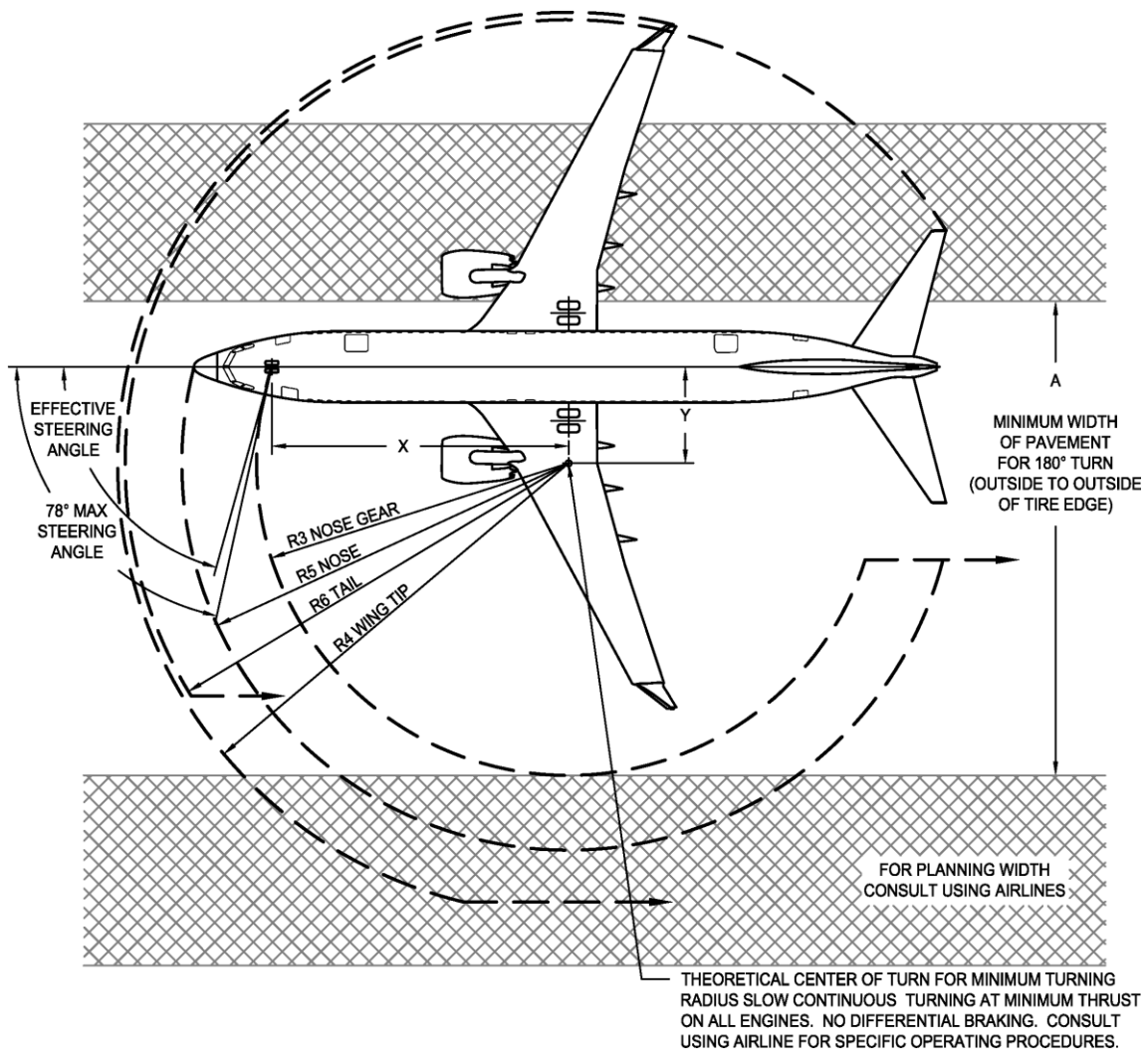

AIRPLANE MODEL	EFFECTIVE TURNING ANGLE (DEG)	X		Y		A		R3		R4		R5		R6	
		FT	M	FT	M	FT	M	FT	M	FT	M	FT	M	FT	M
737-7	75	44	13.4	12	3.7	70	21.3	47	14.3	74	22.6	59	18.0	70	21.3
	73	44	13.4	14	4.3	72	21.9	47	14.3	75	22.9	59	18.0	70	21.3
737-8 / -8-200 / BBJ MAX 8	75	52	15.8	14	4.3	80	24.4	54	16.5	75	22.9	67	20.4	75	22.9
	73	52	15.8	16	4.9	82	25.0	55	16.8	77	23.5	67	20.4	76	23.2
737-9	75	57	17.4	16	4.9	86	26.2	60	18.3	76	23.2	72	21.9	79	24.1
	73	57	17.4	18	5.5	89	27.1	60	18.3	79	24.1	72	21.9	80	24.4

NOTES:

5° TIRE SLIP IS ESTIMATED TO BE THE MAXIMUM TIRE SLIP FOR THE EFFECTIVE STEERING ANGLE OF 73°. THE 3° TIRE SLIP DIMENSIONS ARE FOR COMPARISON PURPOSES. DIMENSIONS ARE ROUNDED UP TO THE NEAREST WHOLE FOOT, THEN CONVERTED TO METERS.

4.4 VISIBILITY FROM COCKPIT IN STATIC POSITION: ALL MODELS

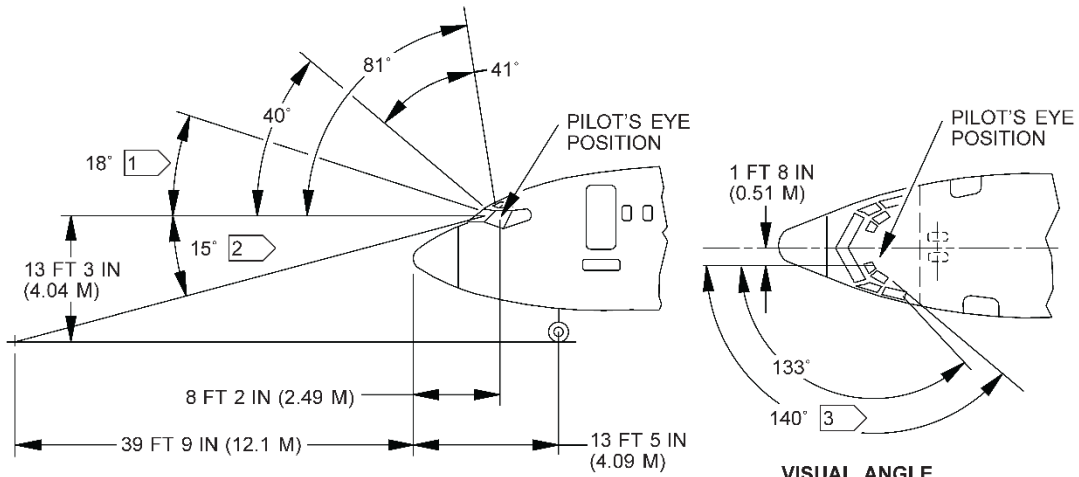

VISUAL ANGLES IN PLANE PARALLEL TO LONGITUDINAL AXIS THROUGH PILOT'S EYE POSITION

VISUAL ANGLE IN HORIZONTAL PLANE THROUGH PILOT'S EYE POSITION

NOT TO BE USED FOR LANDING APPROACH VISIBILITY

NOT TO SCALE

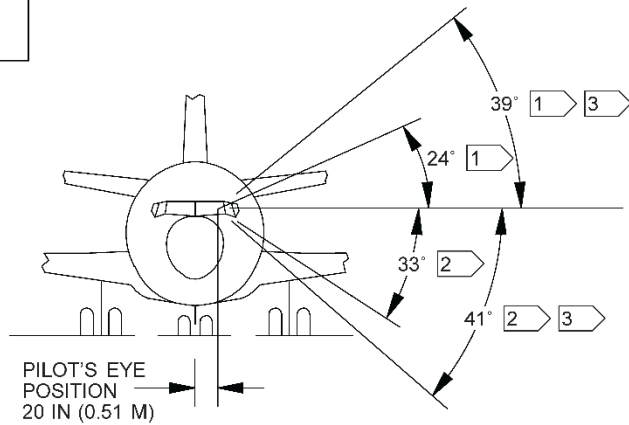

VISUAL ANGLES IN PLANE PERPENDICULAR TO LONGITUDINAL AXIS THROUGH PILOT'S EYE POSITION

NOTE:

HEAD ROTATED ABOUT POINT 3.3 IN. (0.08 M) AFT OF PILOT'S EYE POSITION

- 1) UPWARD VISION THROUGH MAIN WINDOW
- 2) DOWNWARD VISION THROUGH MAIN WINDOW
- 3) WITH HEAD MOVED 5 IN. (0.13 M) OUTBOARD

4.5 RUNWAY AND TAXIWAY TURNPATHS

4.5.1 Runway and Taxiway Turnpaths - Runway-to-Taxiway, More Than 90-Degree Turn: Model 737-7

NOTE: BEFORE DETERMINING THE SIZE OF A FILLET, CHECK WITH THE OPERATING AIRLINES REGARDING THE OPERATING PROCEDURES IN USE AND THE AIRCRAFT TYPES INTENDED TO SERVE THE AIRPORT.

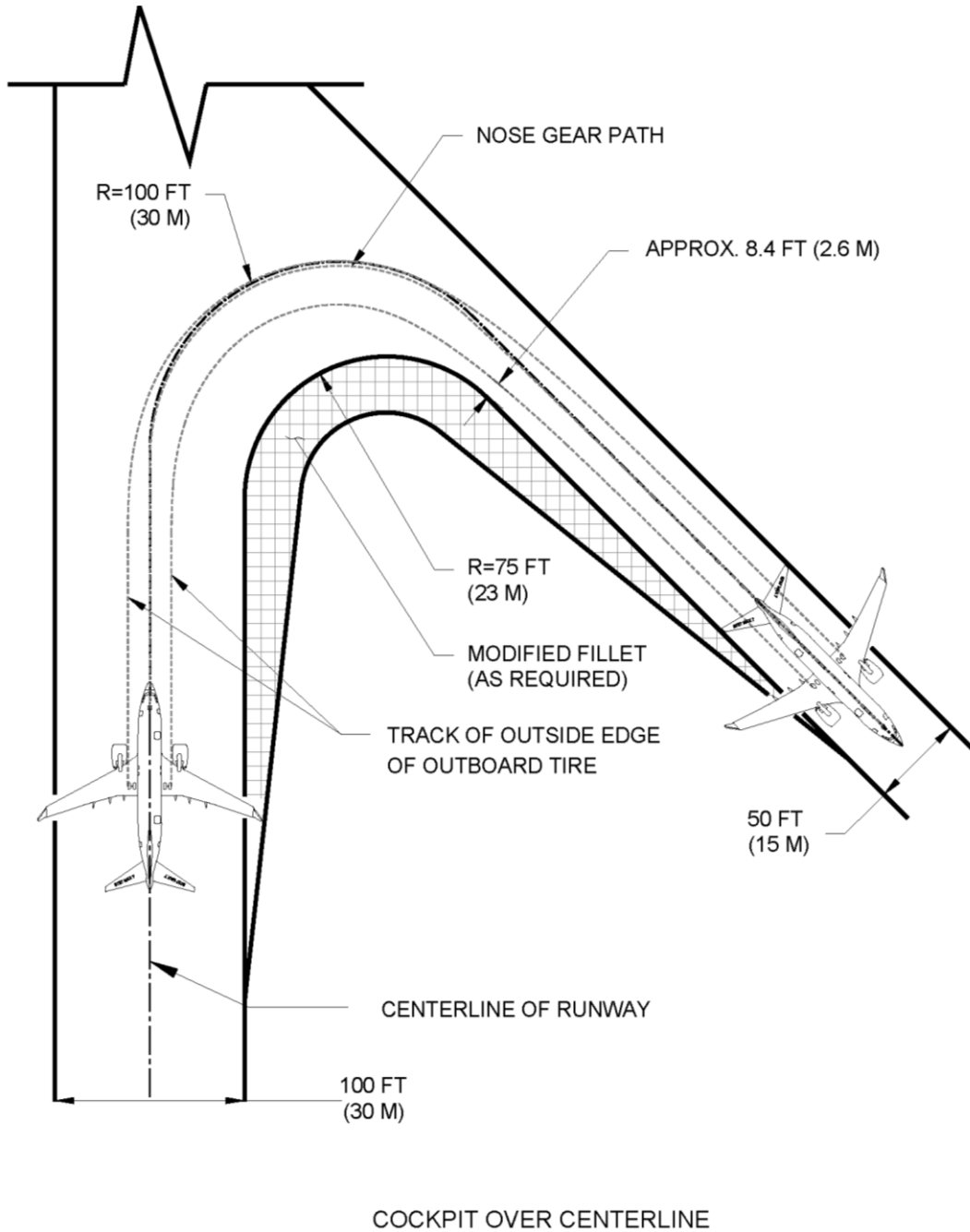

4.5.2 Runway and Taxiway Turnpaths - Runway-to-Taxiway, 90-Degree Turn: Model 737-7

NOTE: BEFORE DETERMINING THE SIZE OF A FILLET, CHECK WITH THE OPERATING AIRLINES REGARDING THE OPERATING PROCEDURES IN USE AND THE AIRCRAFT TYPES INTENDED TO SERVE THE AIRPORT.

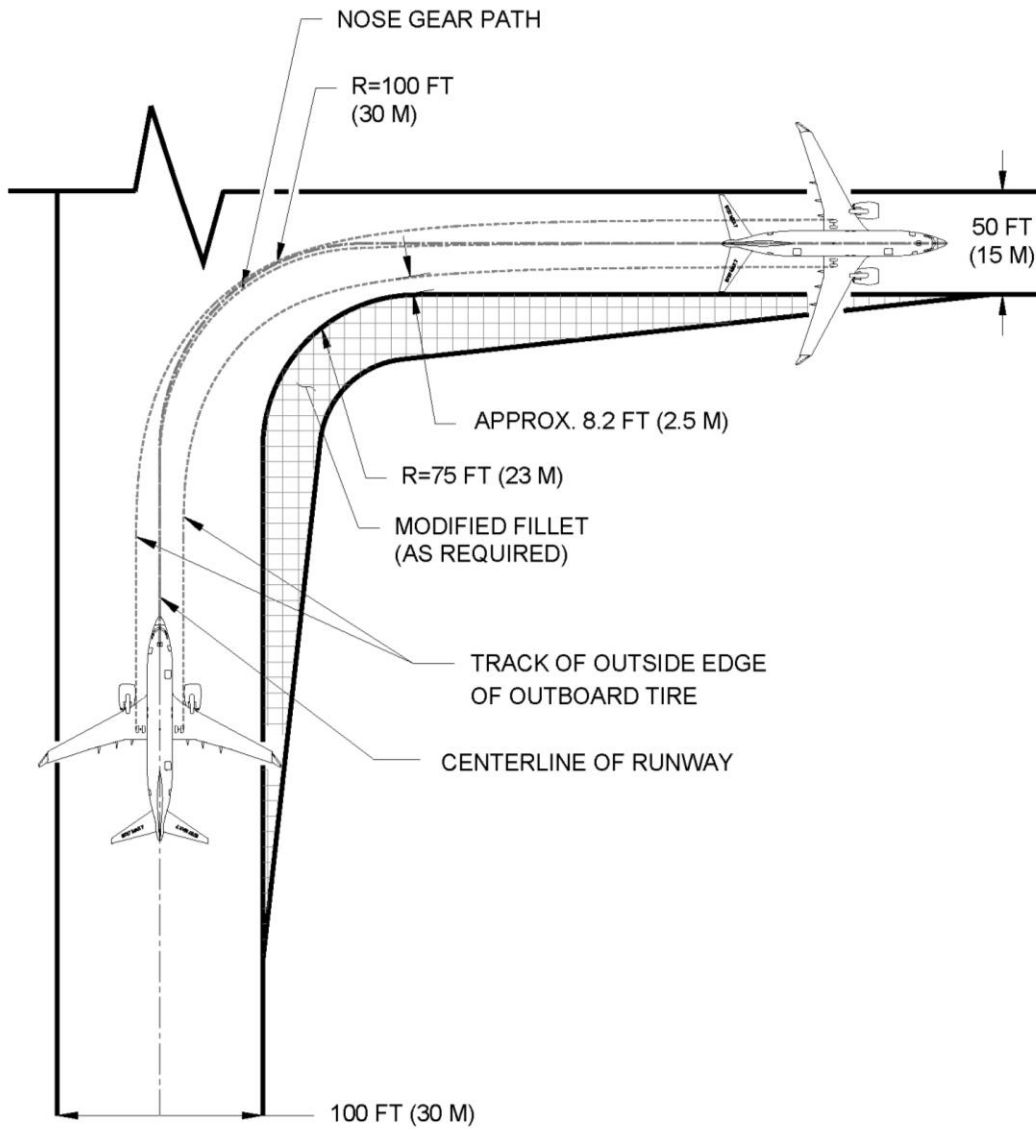

COCKPIT OVER CENTERLINE

4.5.3 Runway and Taxiway Turnpaths - Taxiway-to-Taxiway, 90-Degree Turn: Model 737-7

NOTE: BEFORE DETERMINING THE SIZE OF A FILLET, CHECK WITH THE OPERATING AIRLINES REGARDING THE OPERATING PROCEDURES IN USE AND THE AIRCRAFT TYPES INTENDED TO SERVE THE AIRPORT.

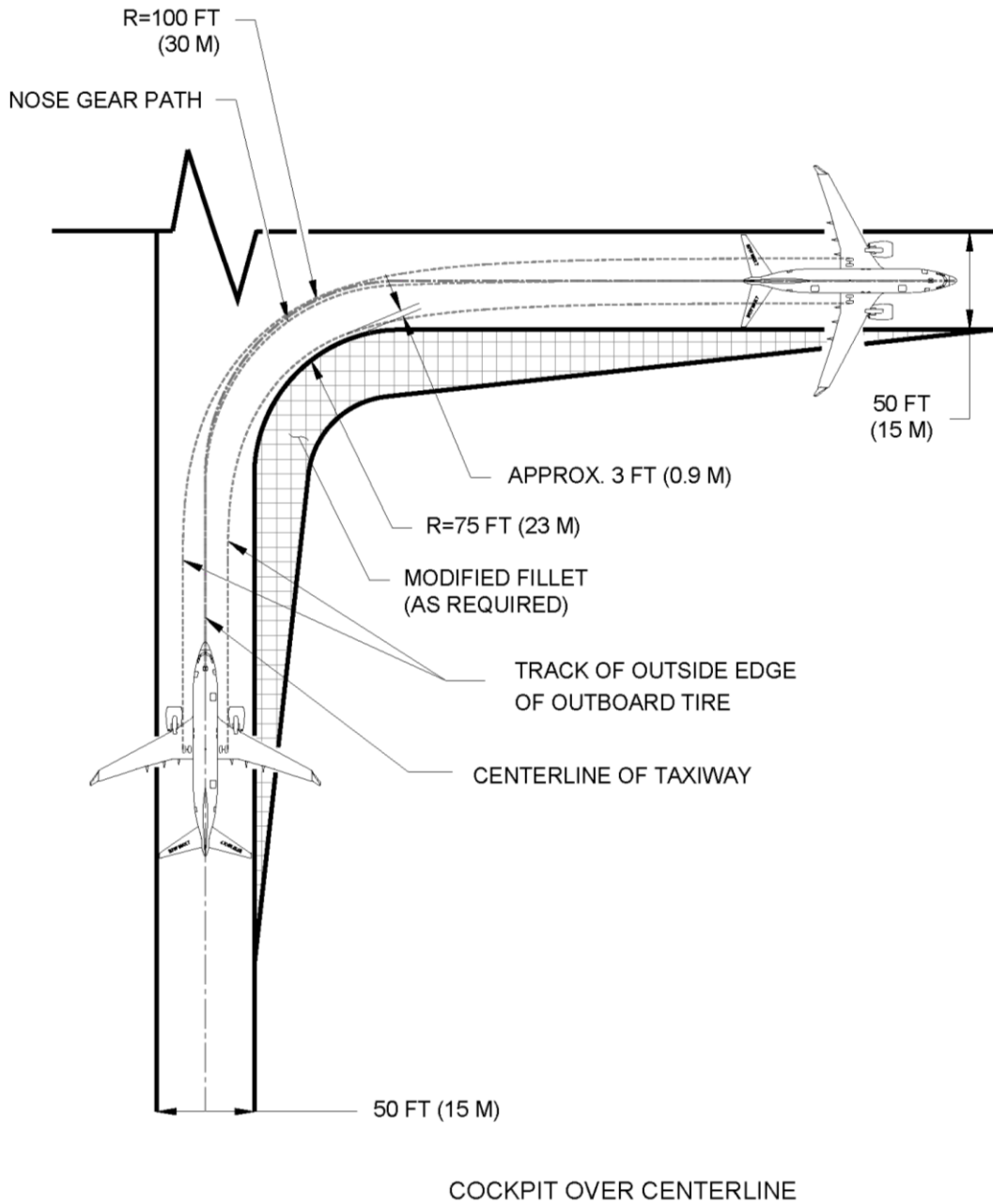

4.5.4 Runway and Taxiway Turnpaths - Runway-to-Taxiway, More Than 90-Degree Turn: Model 737-8 / -8-200 / BBJ MAX 8

NOTE: BEFORE DETERMINING THE SIZE OF A FILLET, CHECK WITH THE OPERATING AIRLINES REGARDING THE OPERATING PROCEDURES IN USE AND THE AIRCRAFT TYPES INTENDED TO SERVE THE AIRPORT.

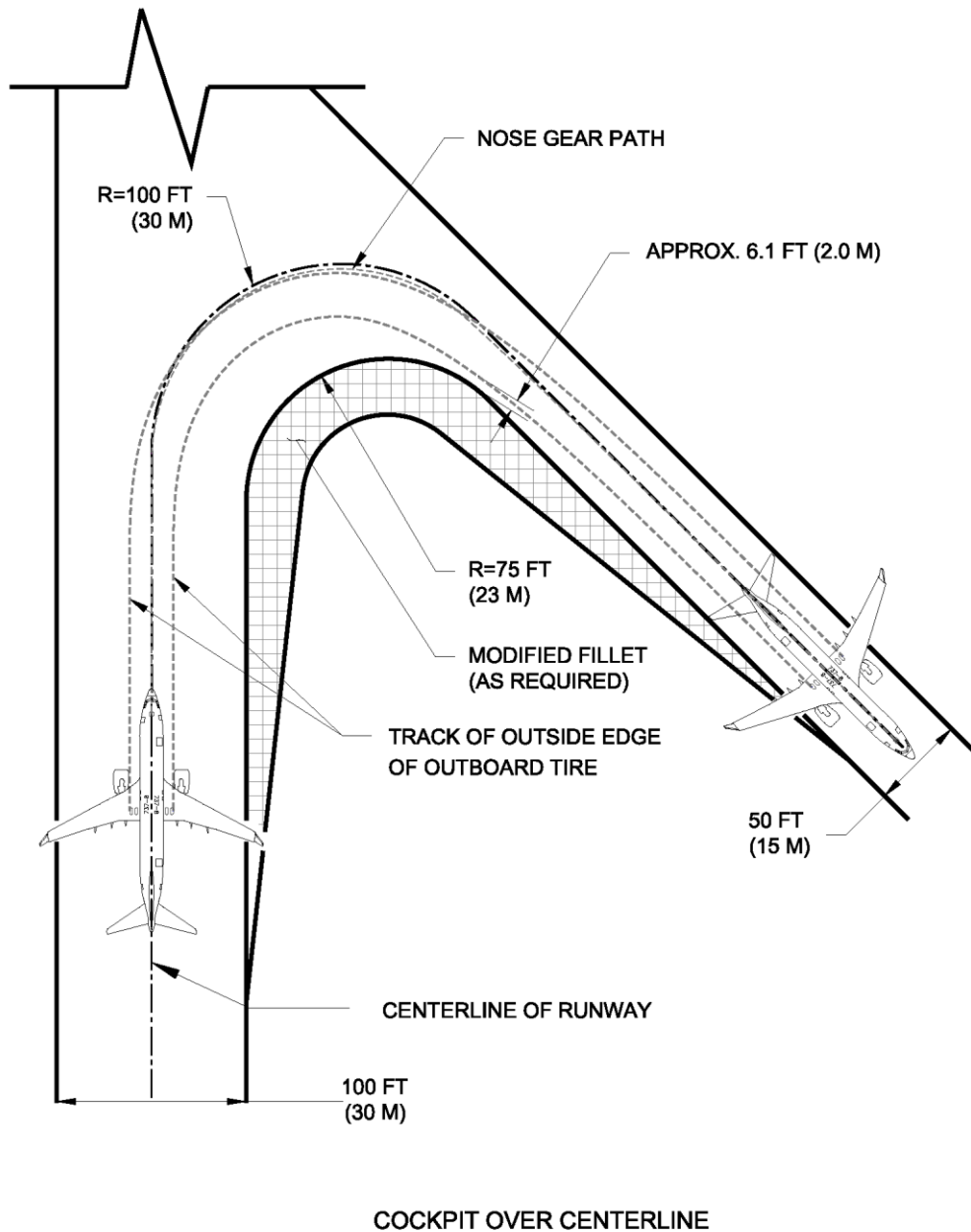

4.5.5 Runway and Taxiway Turnpaths - Runway-to-Taxiway, 90-Degree Turn: Model 737-8 / -8-200 / BBJ MAX 8

NOTE: BEFORE DETERMINING THE SIZE OF A FILLET, CHECK WITH THE OPERATING AIRLINES REGARDING THE OPERATING PROCEDURES IN USE AND THE AIRCRAFT TYPES INTENDED TO SERVE THE AIRPORT.

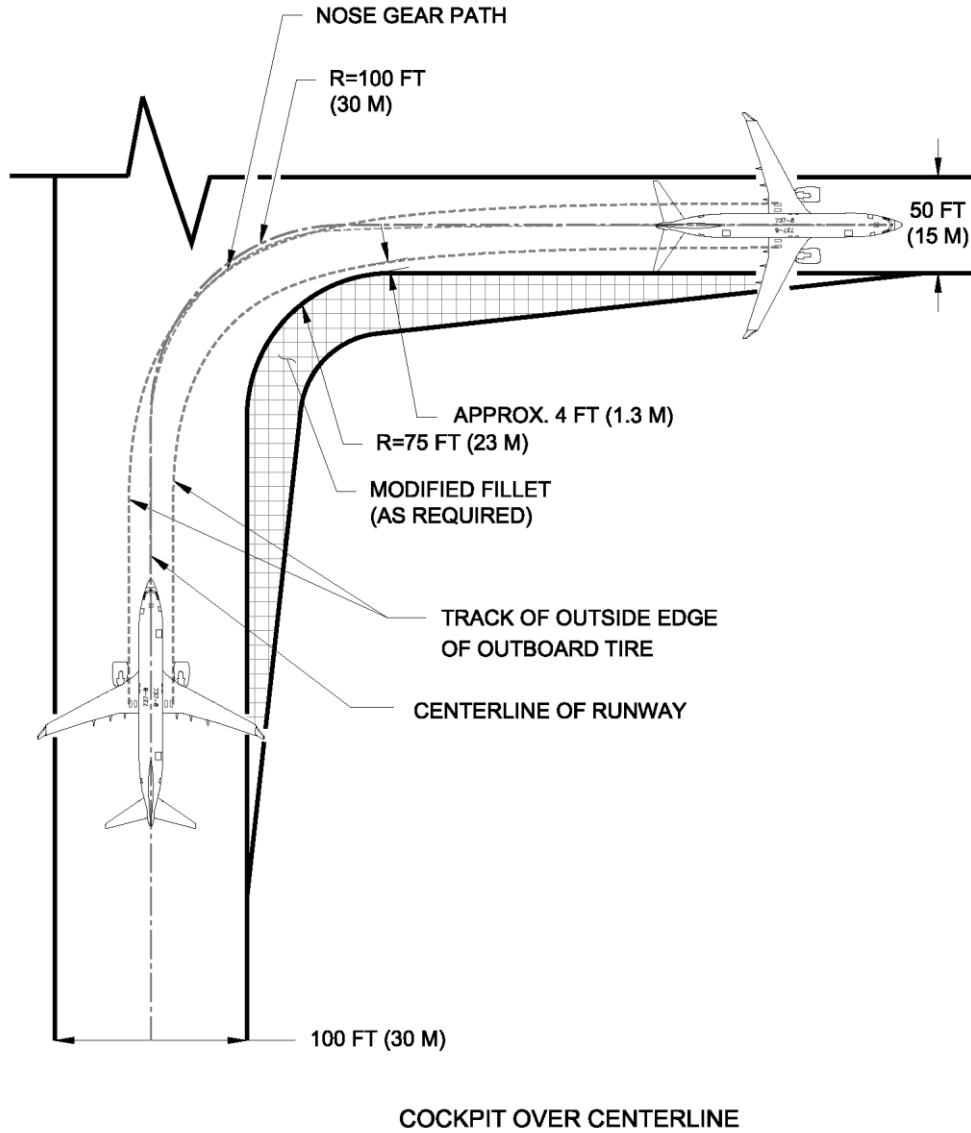

4.5.6 Runway and Taxiway Turnpaths - Taxiway-to-Taxiway, 90-Degree Turn: Model 737-8 / -8-200 / BBJ MAX 8

NOTE: BEFORE DETERMINING THE SIZE OF A FILLET, CHECK WITH THE OPERATING AIRLINES REGARDING THE OPERATING PROCEDURES IN USE AND THE AIRCRAFT TYPES INTENDED TO SERVE THE AIRPORT.

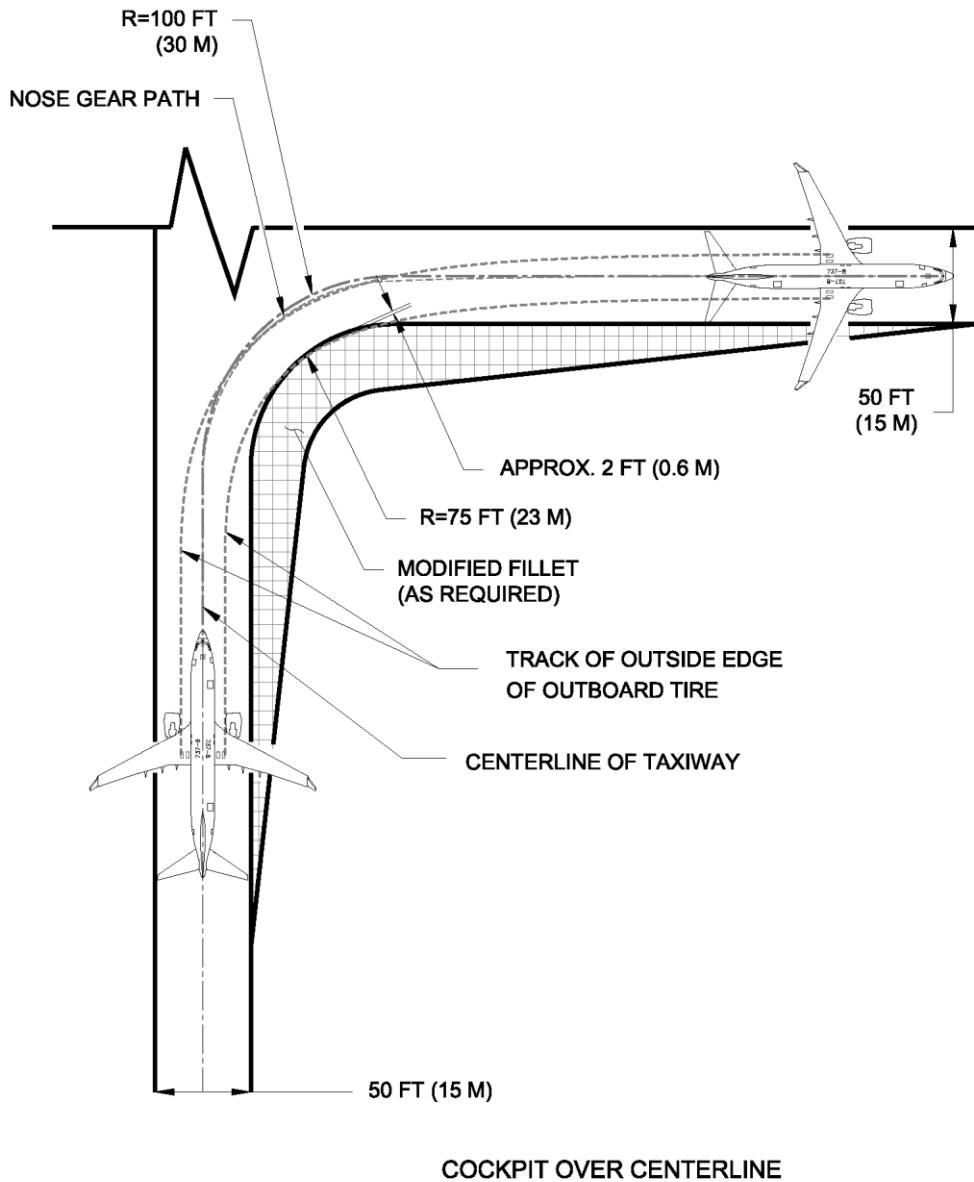

4.5.7 Runway and Taxiway Turnpaths - Runway-to-Taxiway, More Than 90-Degree Turn: Model 737-9

NOTE: BEFORE DETERMINING THE SIZE OF A FILLET, CHECK WITH THE OPERATING AIRLINES REGARDING THE OPERATING PROCEDURES IN USE AND THE AIRCRAFT TYPES INTENDED TO SERVE THE AIRPORT.

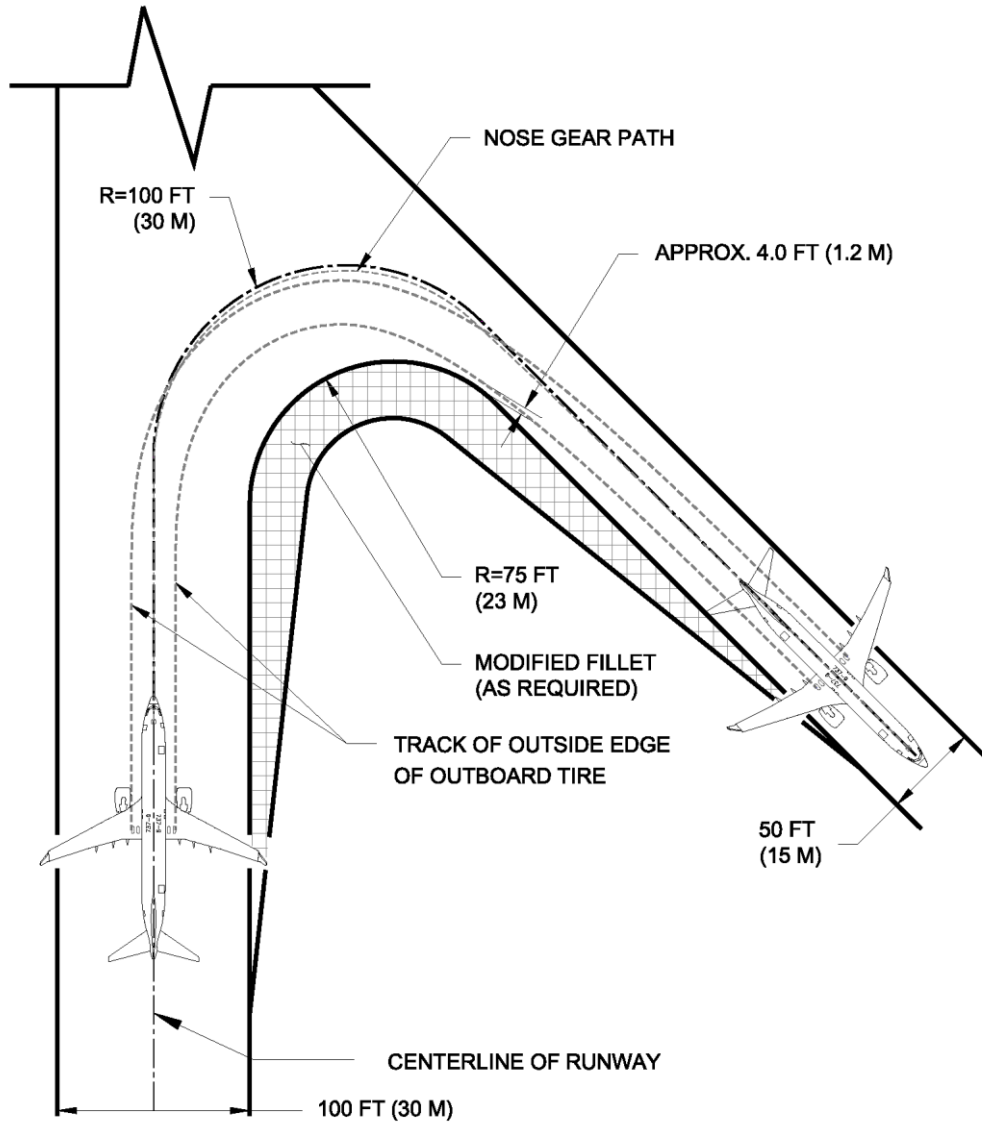

COCKPIT OVER CENTERLINE

4.5.8 Runway and Taxiway Turnpaths - Runway-to-Taxiway, 90-Degree Turn: Model 737-9

NOTE: BEFORE DETERMINING THE SIZE OF A FILLET, CHECK WITH THE OPERATING AIRLINES REGARDING THE OPERATING PROCEDURES IN USE AND THE AIRCRAFT TYPES INTENDED TO SERVE THE AIRPORT.

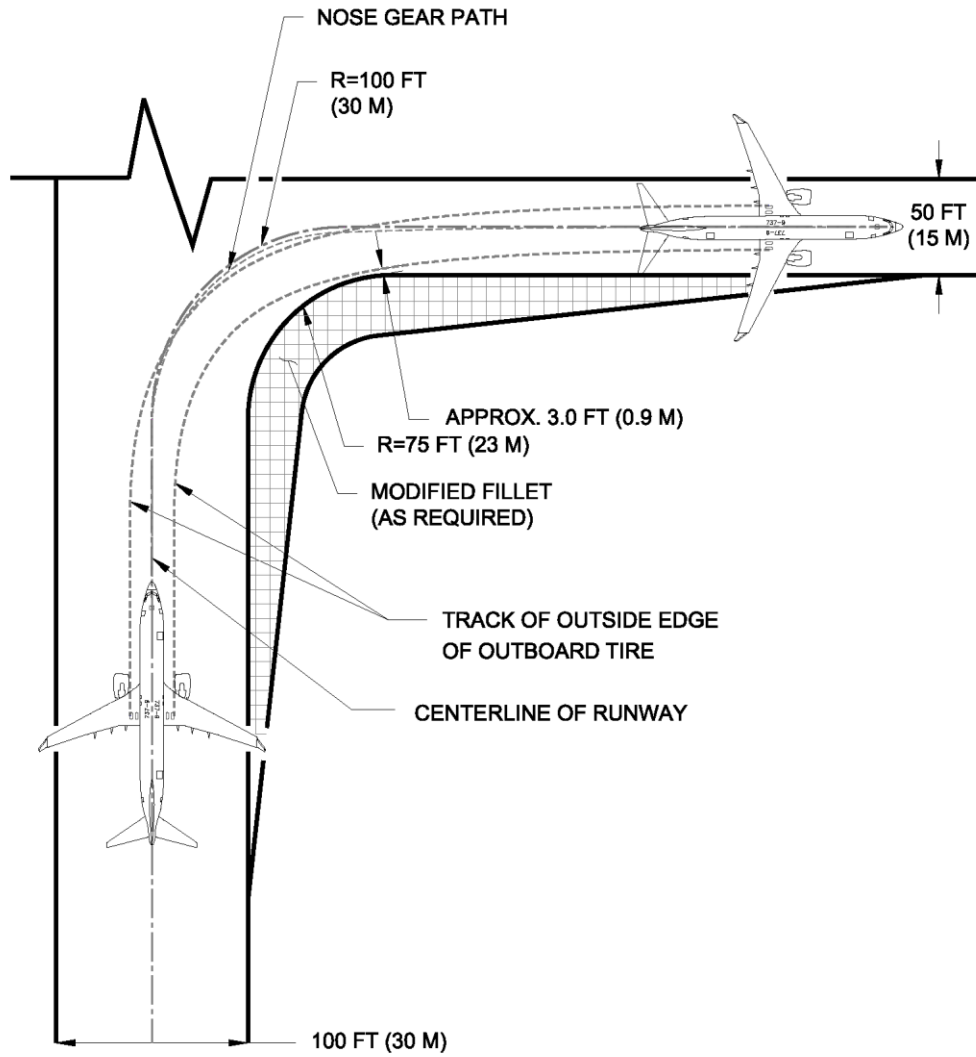

COCKPIT OVER CENTERLINE

4.5.9 Runway and Taxiway Turnpaths - Taxiway-to-Taxiway, 90-Degree Turn: Model 737-9

NOTE: BEFORE DETERMINING THE SIZE OF A FILLET, CHECK WITH THE OPERATING AIRLINES REGARDING THE OPERATING PROCEDURES IN USE AND THE AIRCRAFT TYPES INTENDED TO SERVE THE AIRPORT.

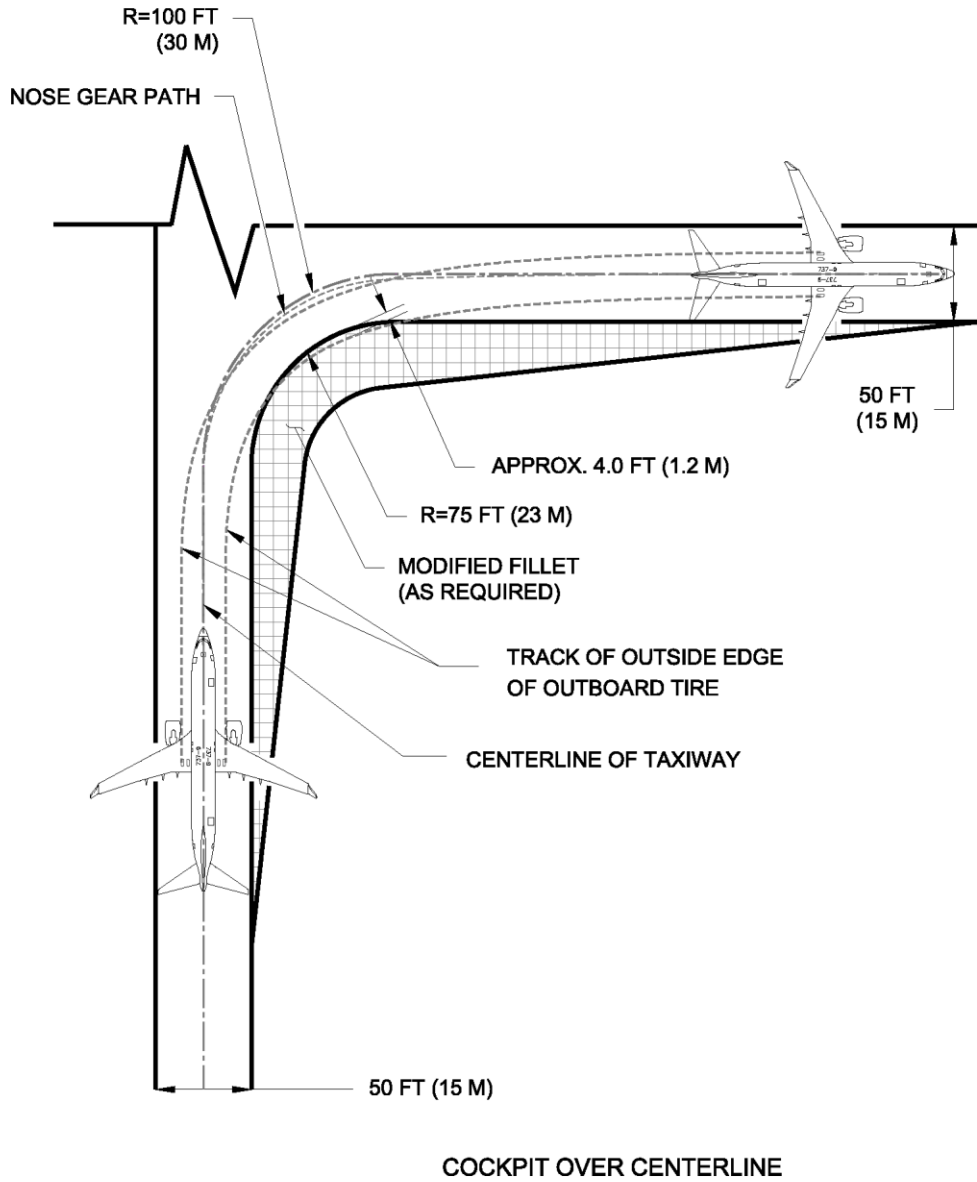

4.6 RUNWAY HOLDING BAY: MODEL 737, ALL MODELS

NOTE: BEFORE DETERMINING THE SIZE OF A HOLDING BAY, CHECK WITH THE OPERATING AIRLINES REGARDING THE OPERATING PROCEDURES IN USE AND THE AIRCRAFT TYPES INTENDED TO SERVE THE AIRPORT.

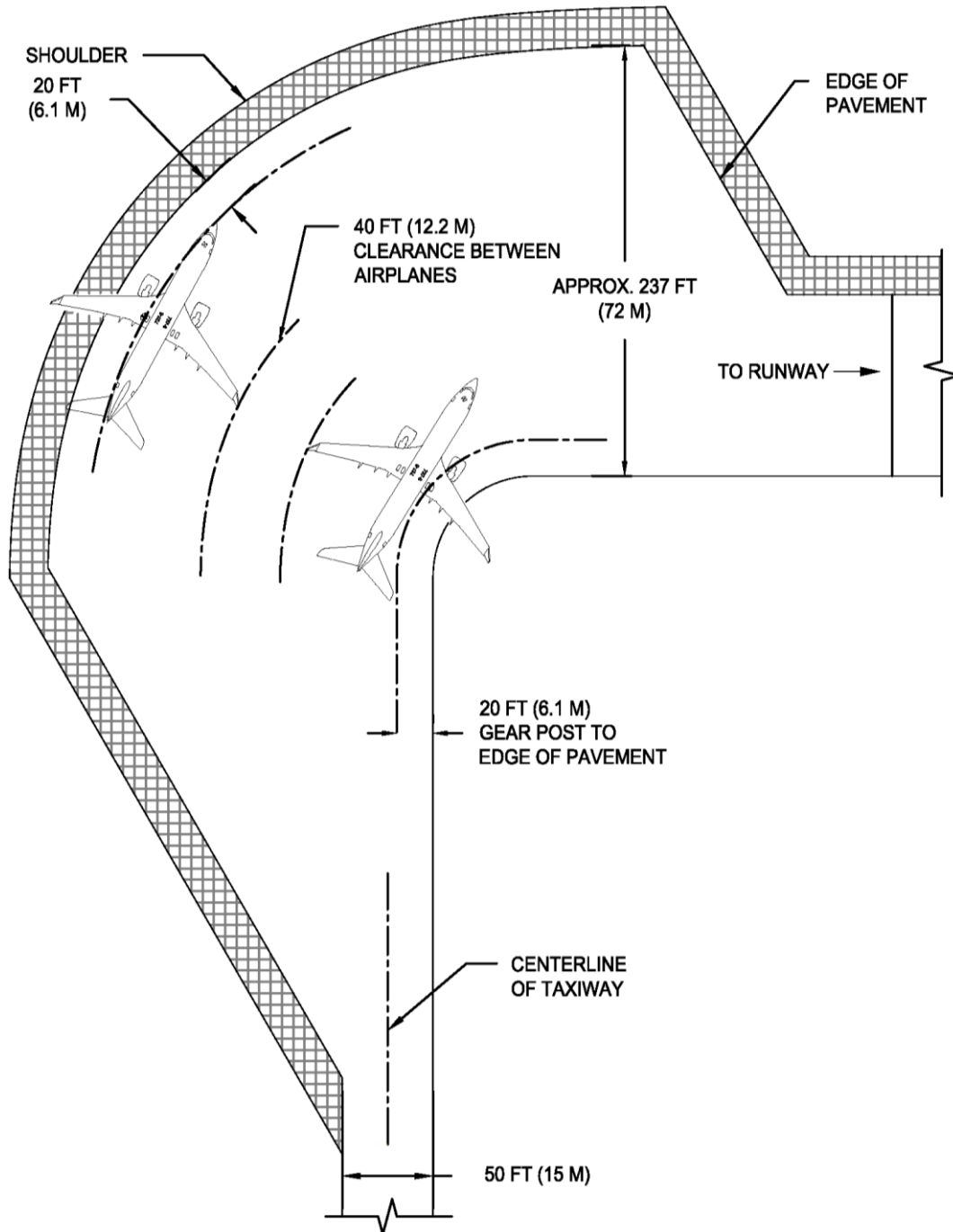

5.0 TERMINAL SERVICING

During turnaround at the terminal, certain services must be performed on the aircraft, usually within a given time, to meet flight schedules. This section shows service vehicle arrangements, schedules, locations of service points, and typical service requirements. The data presented in this section reflect ideal conditions for a single airplane. Service requirements may vary according to airplane condition and airline procedure.

Section 5.1 shows typical arrangements of ground support equipment during turnaround. When the auxiliary power unit (APU) is used, the electrical, air start, and air-conditioning service vehicles may not be required. Passenger loading bridges or portable passenger stairs could be used to load or unload passengers.

Sections 5.2 and 5.3 show typical service times at the terminal. These charts give typical schedules for performing service on the airplane within a given time. Service times could be rearranged to suit availability of personnel, airplane configuration, and degree of service required.

Section 5.4 shows the locations of ground service connections in graphic and in tabular forms. Typical capacities and service requirements are shown in the tables. Services with requirements that vary with conditions are described in subsequent sections.

Section 5.5 shows typical sea level air pressure and flow requirements for starting different engines. The curves are based on an engine start time of 90 seconds.

Section 5.6 shows pneumatic requirements for heating and cooling (air conditioning) using high pressure air to run the air cycle machine. The curves show airflow requirements to heat or cool the airplane within a given time and ambient conditions. Maximum allowable pressure and temperature for air cycle machine operation are 60 psia and 450°F, respectively.

Section 5.7 shows pneumatic requirements for heating and cooling the airplane, using low pressure conditioned air. This conditioned air is supplied through an 8-in ground air connection (GAC) directly to the passenger cabin, bypassing the air cycle machines.

Section 5.8 shows ground towing requirements for various ground surface conditions.

5.1 AIRPLANE SERVICING ARRANGEMENT - TYPICAL TURNAROUND

5.1.1 Airplane Servicing Arrangement - Typical Turnaround: Model 737-7

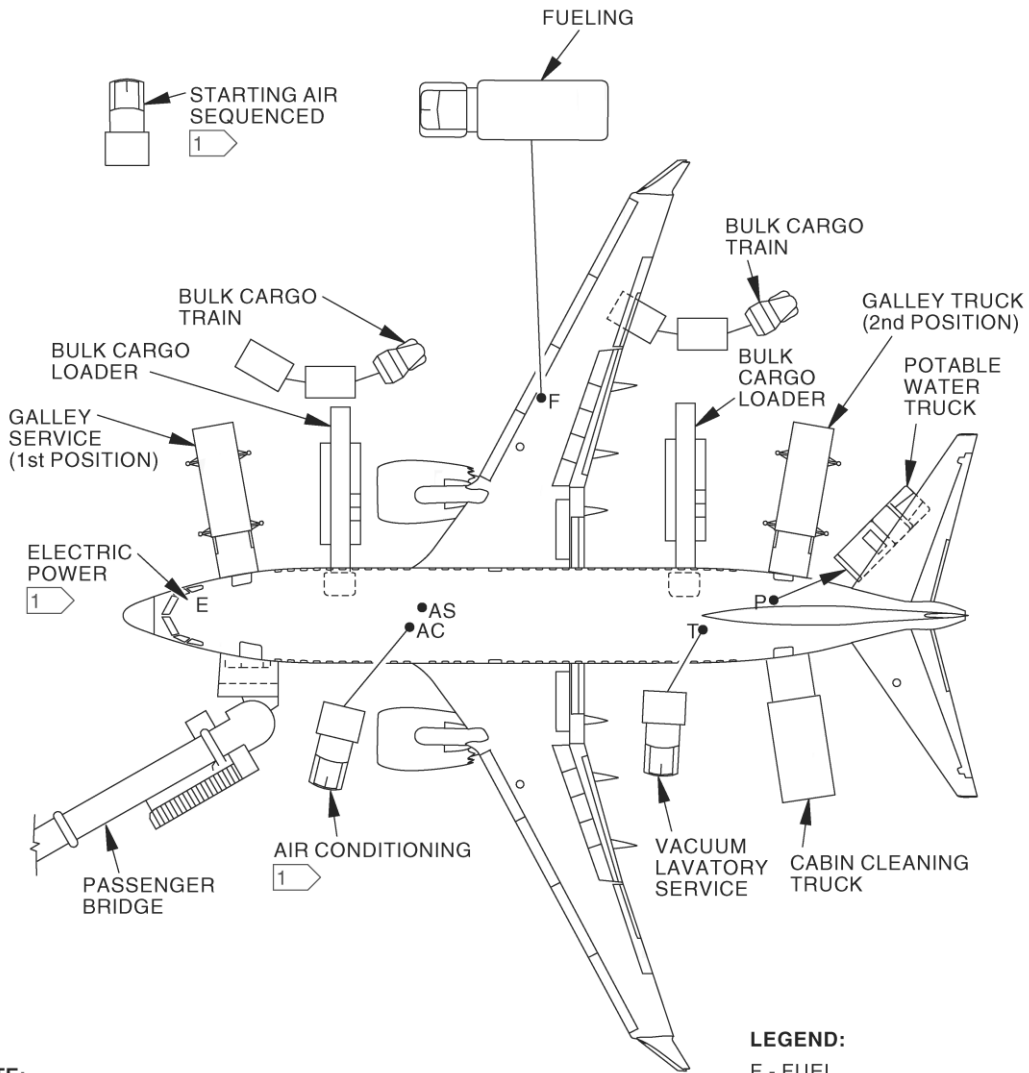

NOTE:

1 NOT REQUIRED IF APU IS IN USE

LEGEND:

- F - FUEL
- T - TOILET SERVICE
- P - POTABLE WATER
- E - ELECTRICAL POWER
- AC - AIR CONDITIONING
- AS - AIR START

5.1.2 Airplane Servicing Arrangement - Typical Turnaround: Model 737-8 / -8-200 / BBJ MAX 8

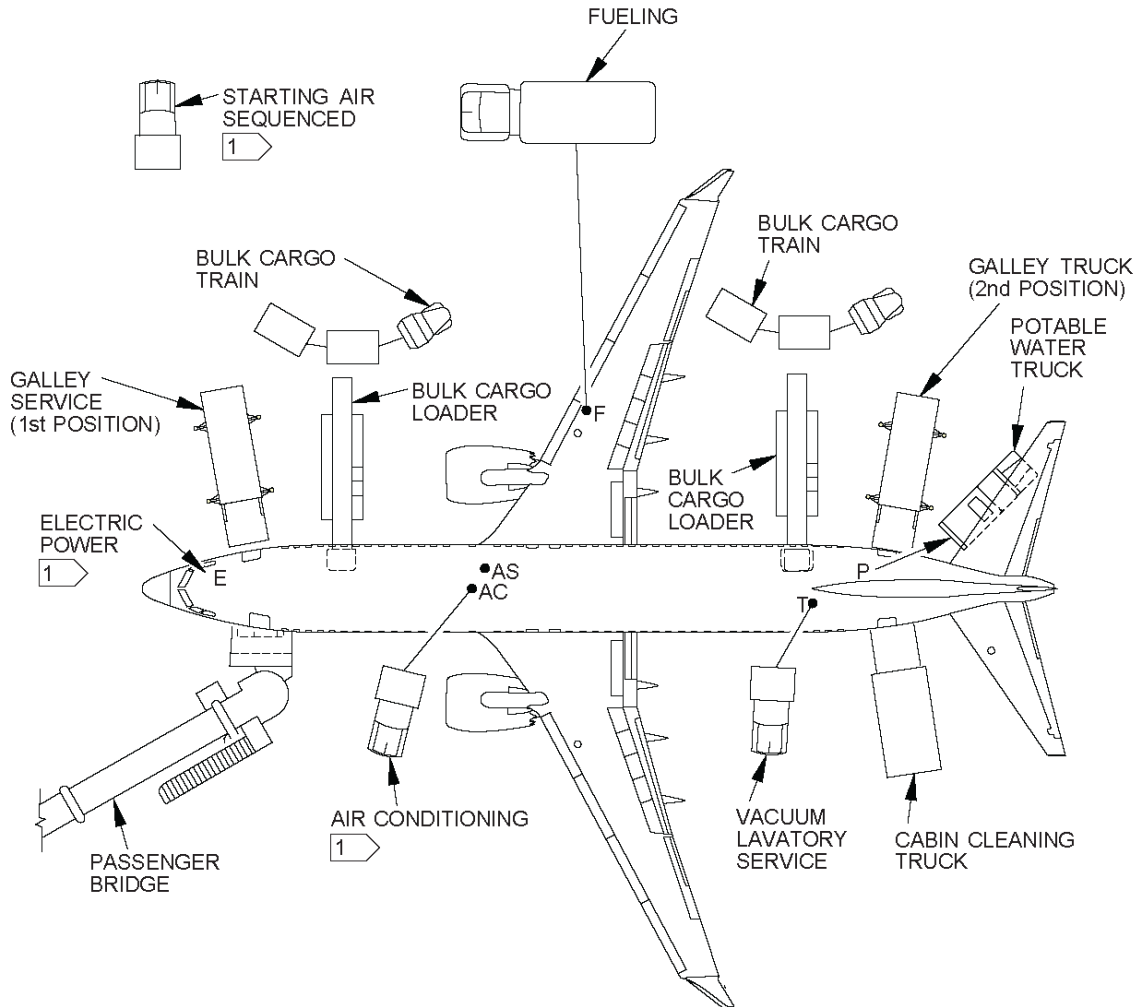

NOTE:

1 NOT REQUIRED IF APU IS IN USE

LEGEND:

- F - FUEL
- T - TOILET SERVICE
- P - POTABLE WATER
- E - ELECTRICAL POWER
- AC - AIR CONDITIONING
- AS - AIR START

5.1.3 Airplane Servicing Arrangement - Typical Turnaround: Model 737-9

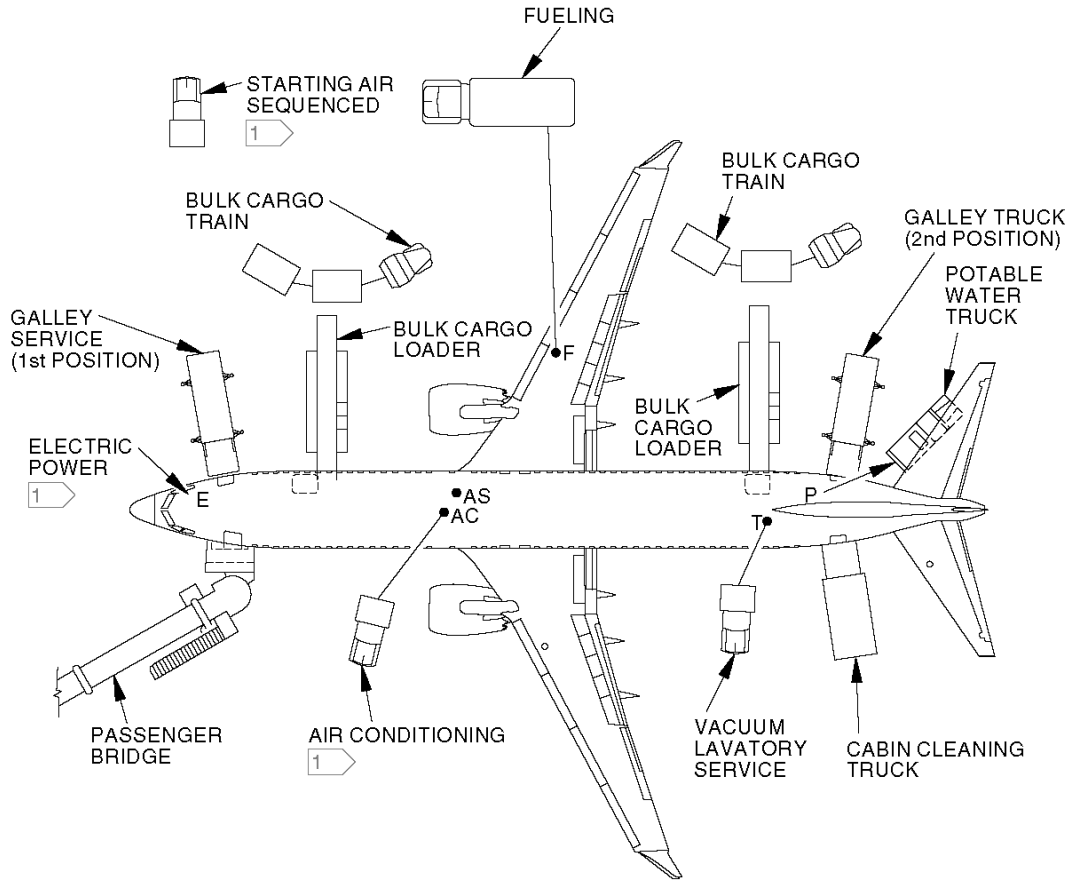

NOTE:

1 NOT REQUIRED IF APU IS IN USE

LEGEND:

- F - FUEL
- T - TOILET SERVICE
- P - POTABLE WATER
- E - ELECTRICAL POWER
- AC - AIR CONDITIONING
- AS - AIR START

5.1.4 Airplane Servicing Arrangement - Typical En Route: All Models

737-8 Shown

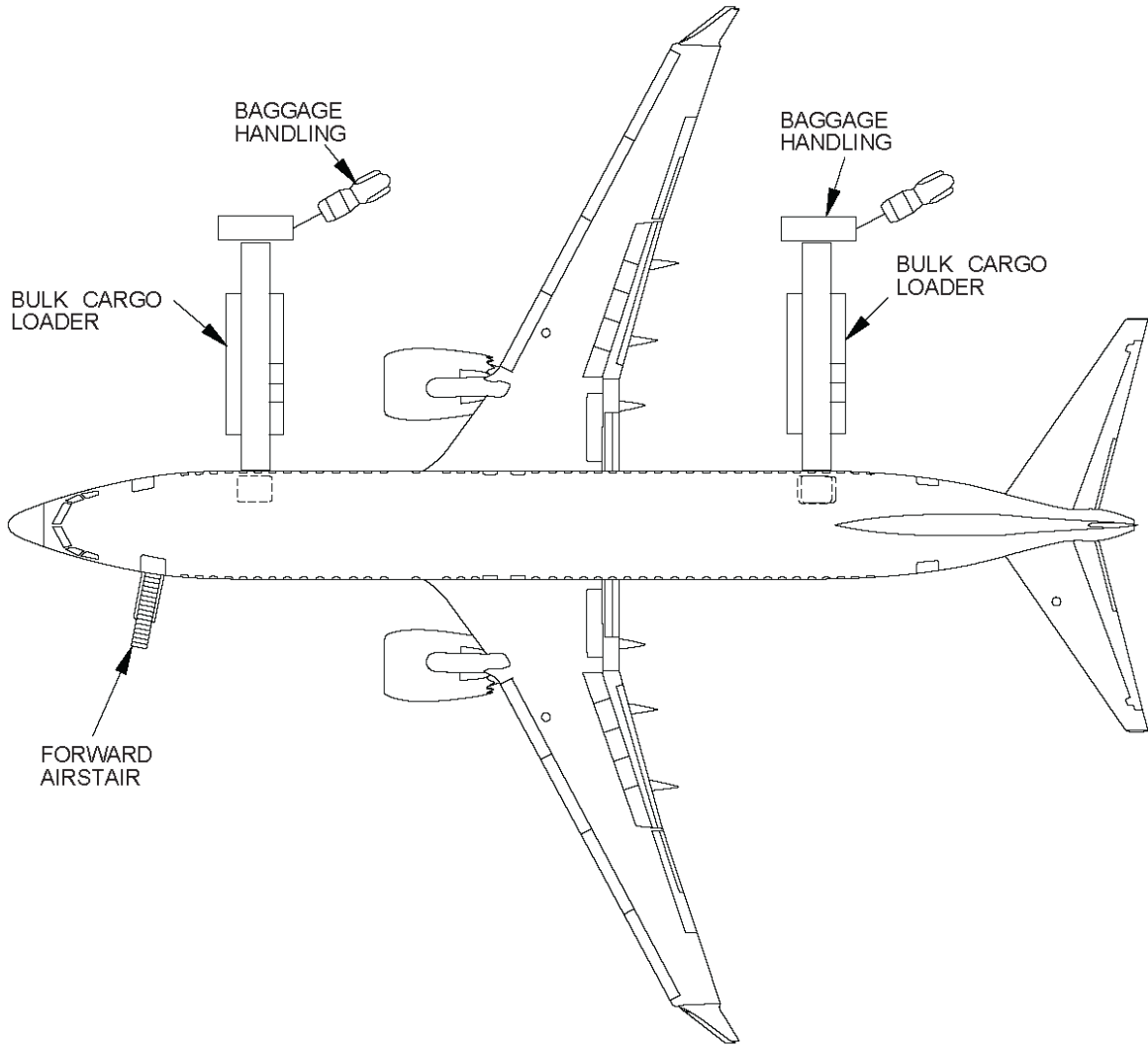

5.2 TERMINAL OPERATIONS - TURNAROUND STATION

5.2.1 Terminal Operations – Turnaround Station: Model 737-7

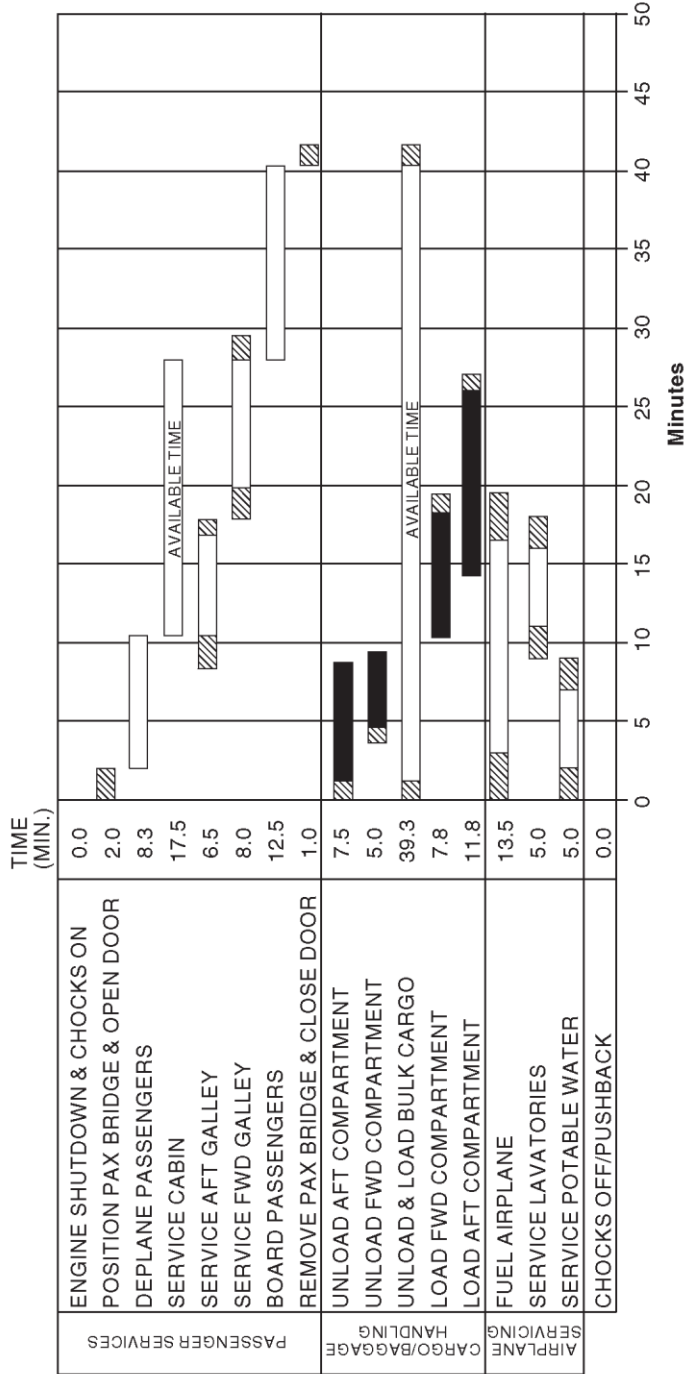

PARAMETERS:

- 100% PASSENGER AND CARGO EXCHANGE
- 150 PASSENGERS, 1 CLASS, 1 DOOR
- PASSENGER DEPLANE RATE IS 18 PER MINUTE
- PASSENGER BOARDING RATE IS 12 PER MINUTE
- (1) GALLEY SERVICE TRUCK
- UNLOAD AND LOAD BULK CARGO IS AVAILABLE TIME
- (1) LAVATORY SERVICE TRACK
- (1) POTABLE WATER SERVICE TRACK
- 19976 L (5277 GAL.) FUEL LOADED WITH 5966 L (1576 GAL.) RESERVE
- (2) NOZZLE HYDRANT FUELING AT 50 PSIG

LEGEND:

- POSITION EQUIPMENT
- CRITICAL PATH

5.2.2 Terminal Operations – Turnaround Station: Model 737-8

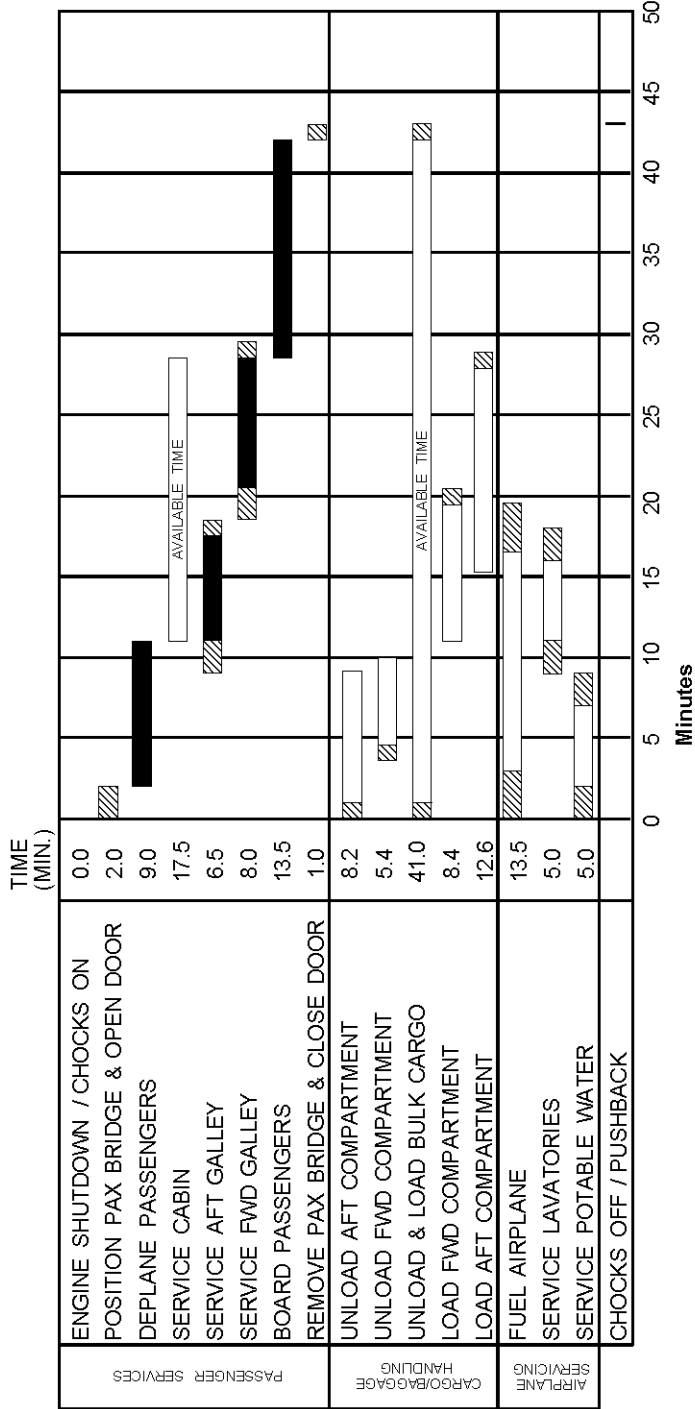

LEGEND:
 POSITION EQUIPMENT
 CRITICAL PATH

- PARAMETERS:
- 100% PASSENGER AND CARGO EXCHANGE
 - 162 PASSENGERS, 2 CLASSES, 1 DOOR
 - PASSENGER DEPLANE RATE IS 18 PER MINUTE
 - PASSENGER BOARDING RATE IS 12 PER MINUTE
 - (1) GALLEY SERVICE TRUCK
 - UNLOAD AND LOAD BULK CARGO IS AVAILABLE TIME
 - (1) LAVATORY SERVICE TRACK
 - (1) POTABLE WATER SERVICE TRACK
 - 19976 L (5277 GAL.) FUEL LOADED WITH 5966 L (1576 GAL.) RESERVE
 - (2) NOZZLE HYDRANT FUELING AT 50 PSIG

5.2.3 Terminal Operations – Turnaround Station: Model 737-8-200

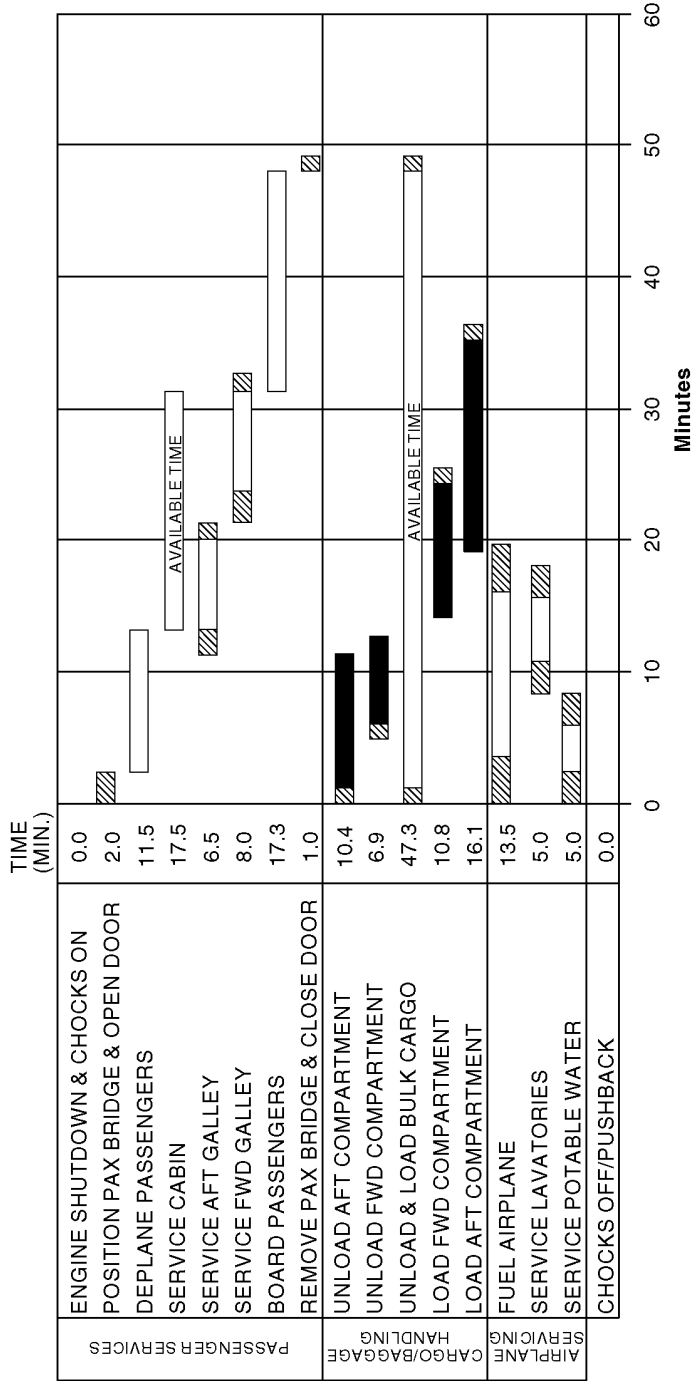

LEGEND:
 POSITION EQUIPMENT
 CRITICAL PATH

- PARAMETERS:**
- 100% PASSENGER AND CARGO EXCHANGE
 - 207 PASSENGERS, 1 CLASS, 1 DOOR
 - PASSENGER DEPLANE RATE IS 18 PER MINUTE
 - PASSENGER BOARDING RATE IS 12 PER MINUTE
 - (1) GALLEY SERVICE TRUCK
 - UNLOAD AND LOAD BULK CARGO IS AVAILABLE TIME
 - (1) LAVATORY SERVICE TRACK
 - (1) POTABLE WATER SERVICE TRACK
 - 19976 L (5277 GAL.) FUEL LOADED WITH 5966 L (1576 GAL.) RESERVE
 - (2) NOZZLE HYDRANT FUELING AT 50 PSIG

5.2.4 Terminal Operations – Turnaround Station: Model 737-9

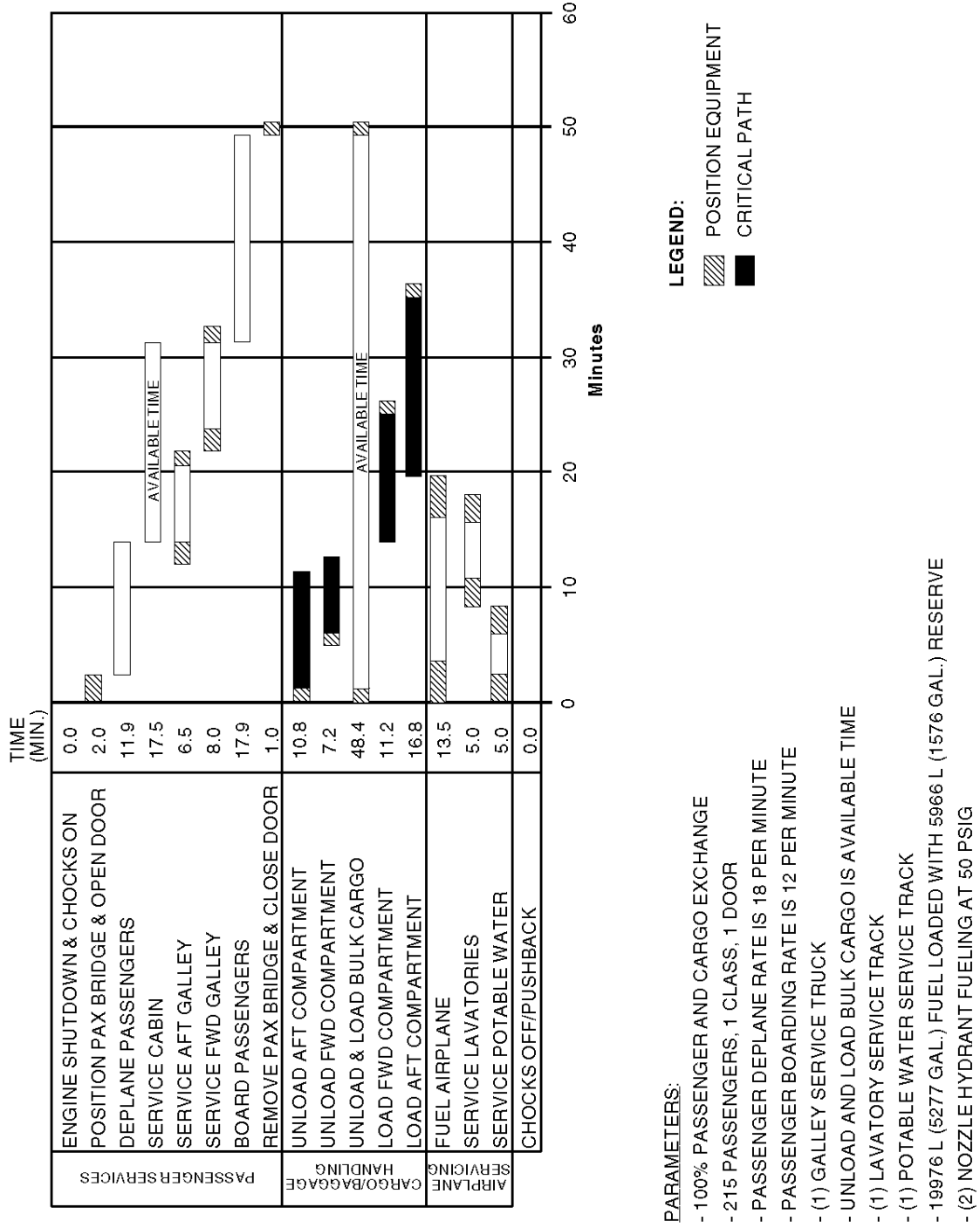

5.3 TERMINAL OPERATIONS - EN ROUTE STATION

5.3.1 Terminal Operations - En Route Station: Model 737-7

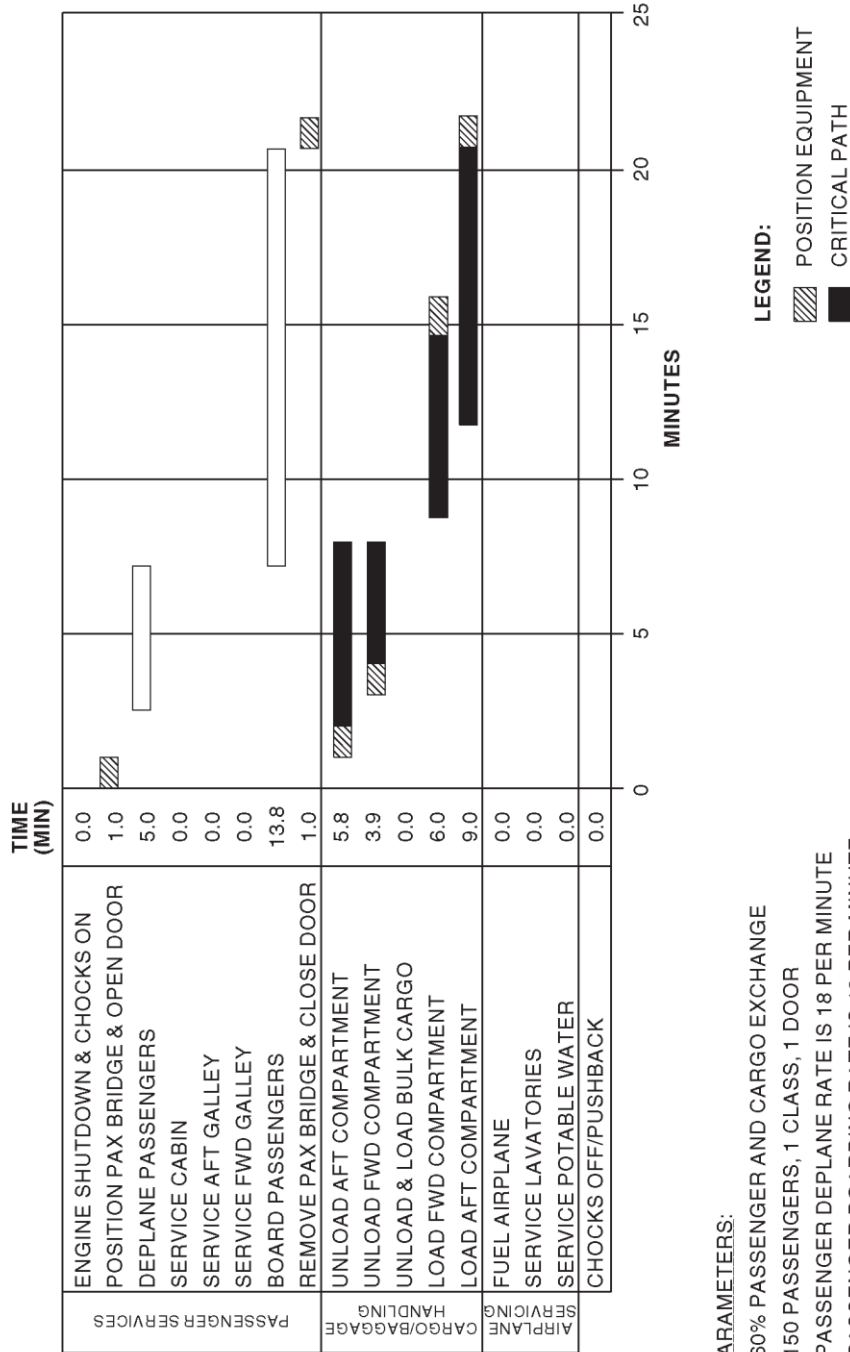

- PARAMETERS:
- 60% PASSENGER AND CARGO EXCHANGE
 - 150 PASSENGERS, 1 CLASS, 1 DOOR
 - PASSENGER DEPLANE RATE IS 18 PER MINUTE
 - PASSENGER BOARDING RATE IS 12 PER MINUTE
 - (1) GALLEY SERVICE TRUCK
 - 1 BAG PER PAX
 - NO BULK CARGO
 - (1) LAVATORY SERVICE TRACK
 - (1) POTABLE WATER SERVICE TRACK
 - 19976 L (5277 GAL.) FUEL LOADED WITH 5966 L (1576 GAL.) RESERVE
 - (2) NOZZLE HYDRANT FUELING AT 50 PSIG

5.3.2 Terminal Operations - En Route Station: Model 737-8

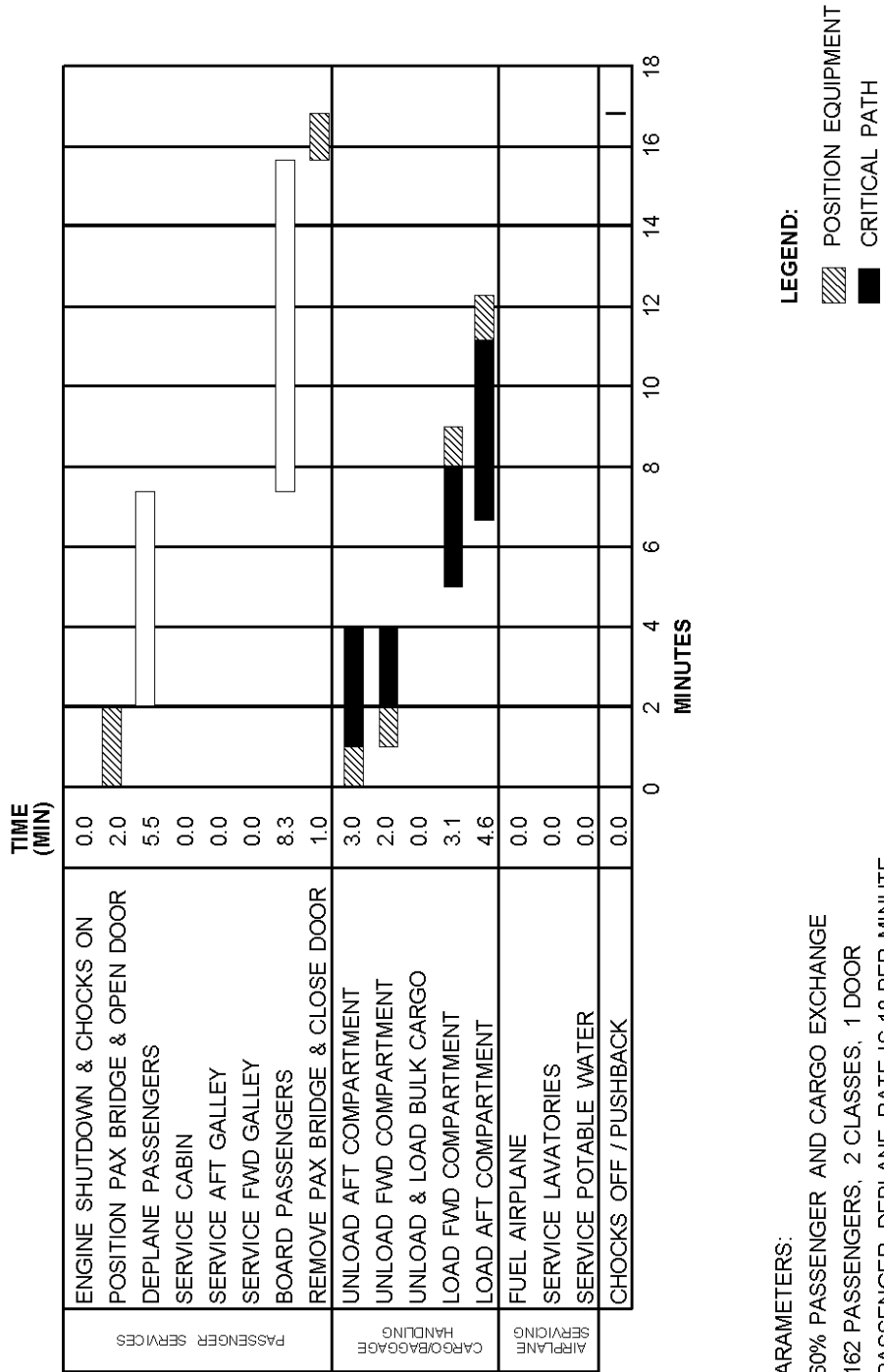

PARAMETERS:

- 60% PASSENGER AND CARGO EXCHANGE
- 162 PASSENGERS, 2 CLASSES, 1 DOOR
- PASSENGER DEPLANE RATE IS 18 PER MINUTE
- PASSENGER BOARDING RATE IS 12 PER MINUTE

LEGEND:

- ▨ POSITION EQUIPMENT
- CRITICAL PATH

5.3.3 Terminal Operations - En Route Station: Model 737-8-200

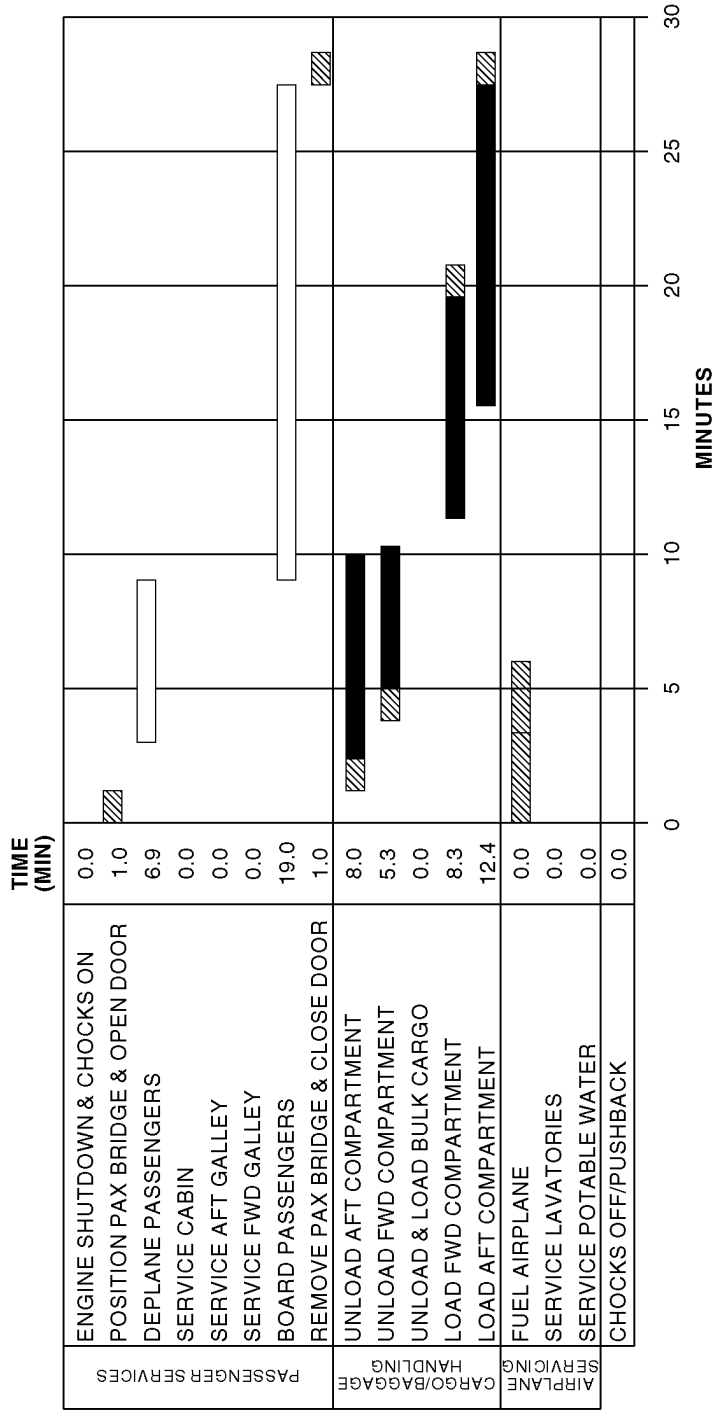

PARAMETERS:

- 60% PASSENGER AND CARGO EXCHANGE
- 207 PASSENGERS, 1 CLASS, 1 DOOR
- PASSENGER DEPLANE RATE IS 18 PER MINUTE
- PASSENGER BOARDING RATE IS 12 PER MINUTE
- (1) GALLEY SERVICE TRUCK
- 1 BAG PER PAX
- NO BULK CARGO
- (1) LAVATORY SERVICE TRACK
- (1) POTABLE WATER SERVICE TRACK
- 19976 L (5277 GAL.) FUEL LOADED WITH 5966 L (1576 GAL.) RESERVE
- (2) NOZZLE HYDRANT FUELING AT 50 PSIG

LEGEND:

- POSITION EQUIPMENT
- CRITICAL PATH

5.3.4 Terminal Operations - En Route Station: Model 737-9

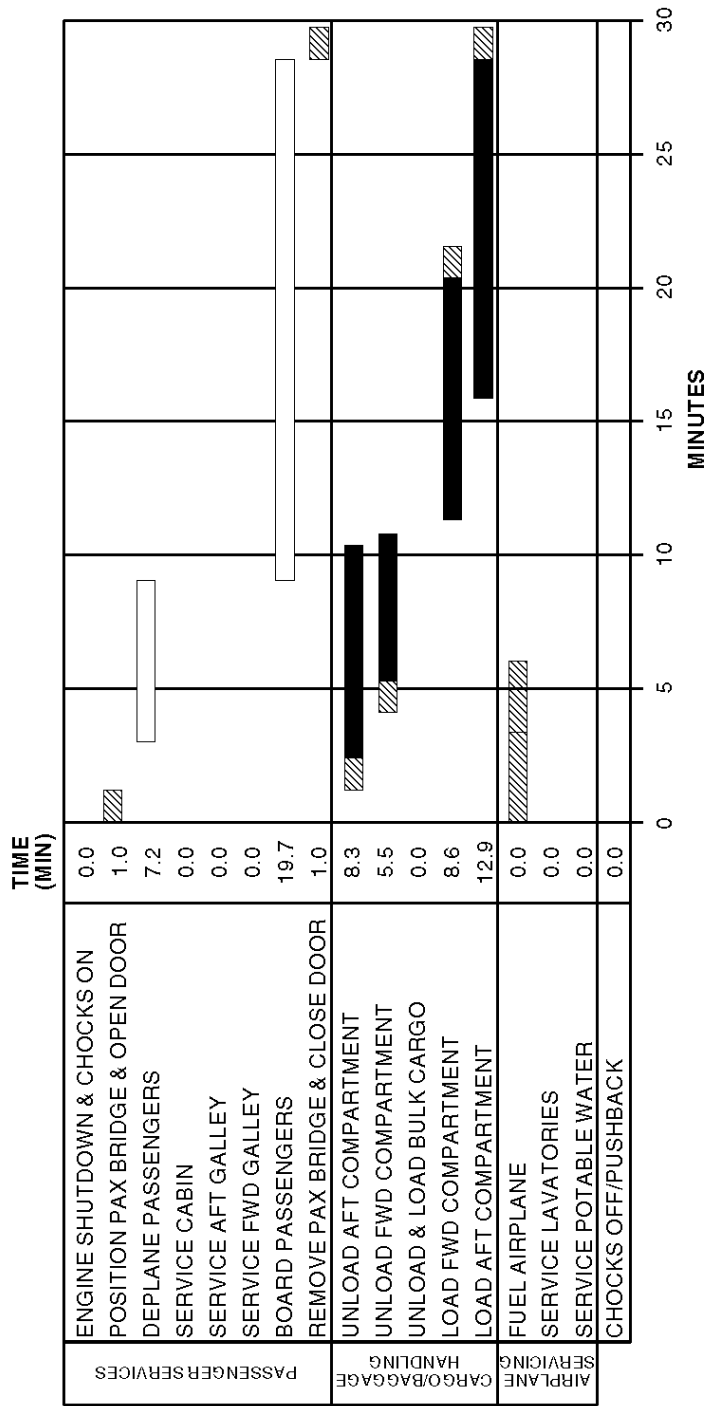

PARAMETERS:

- 60% PASSENGER AND CARGO EXCHANGE
- 215 PASSENGERS, 1 CLASS, 1 DOOR
- PASSENGER DEPLANE RATE IS 18 PER MINUTE
- PASSENGER BOARDING RATE IS 12 PER MINUTE
- (1) GALLEY SERVICE TRUCK
- 1 BAG PER PAX
- NO BULK CARGO
- (1) LAVATORY SERVICE TRACK
- (1) POTABLE WATER SERVICE TRACK
- 19976 L (5277 GAL.) FUEL LOADED WITH 5966 L (1576 GAL.) RESERVE
- (2) NOZZLE HYDRANT FUELING AT 50 PSIG

LEGEND:

- POSITION EQUIPMENT
- CRITICAL PATH

5.4 GROUND SERVICING CONNECTIONS

5.4.1 Ground Service Connections - Locations: Model 737-7

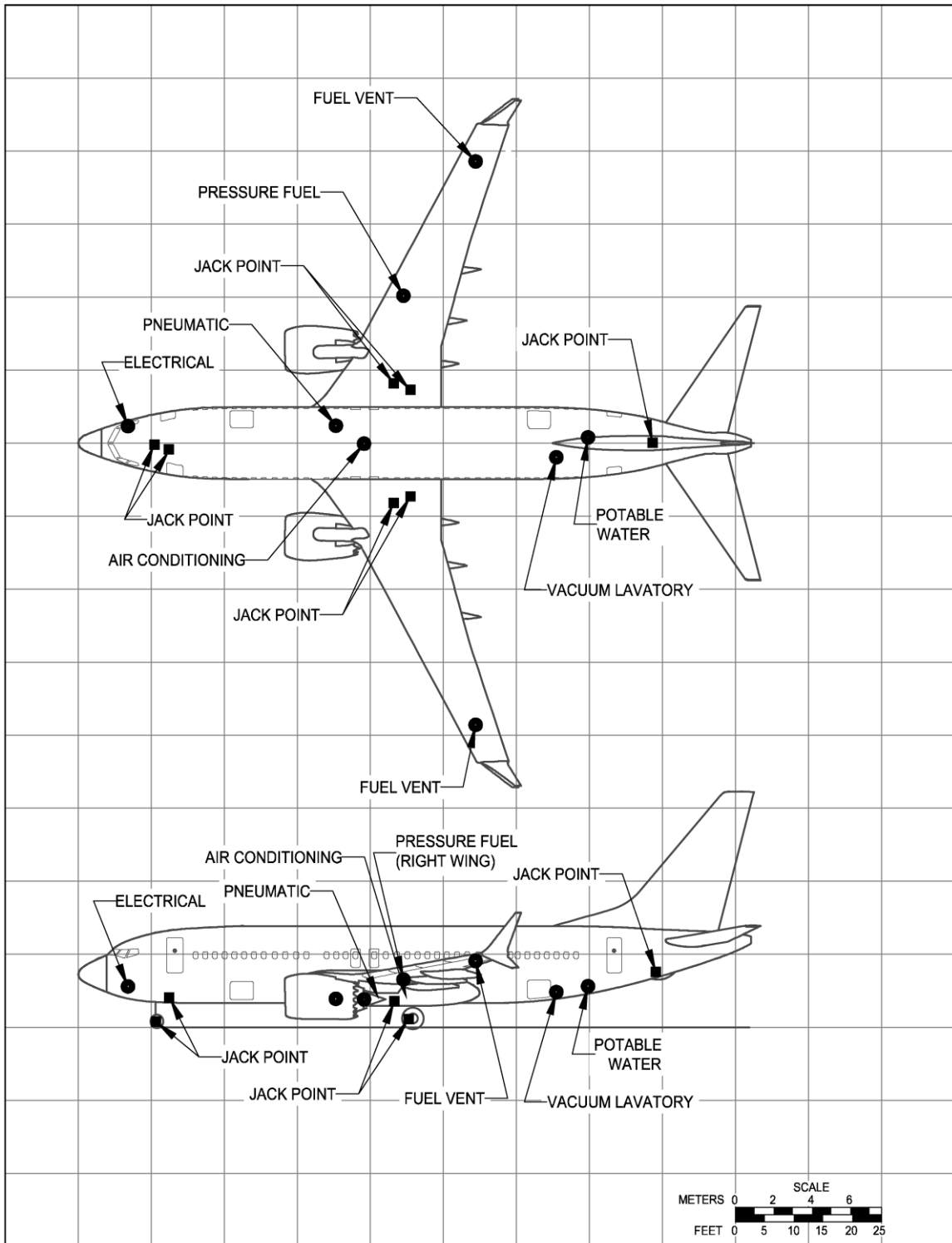

5.4.2 Ground Service Connections - Locations: Model 737-8 /-8-200 / BBJ MAX 8

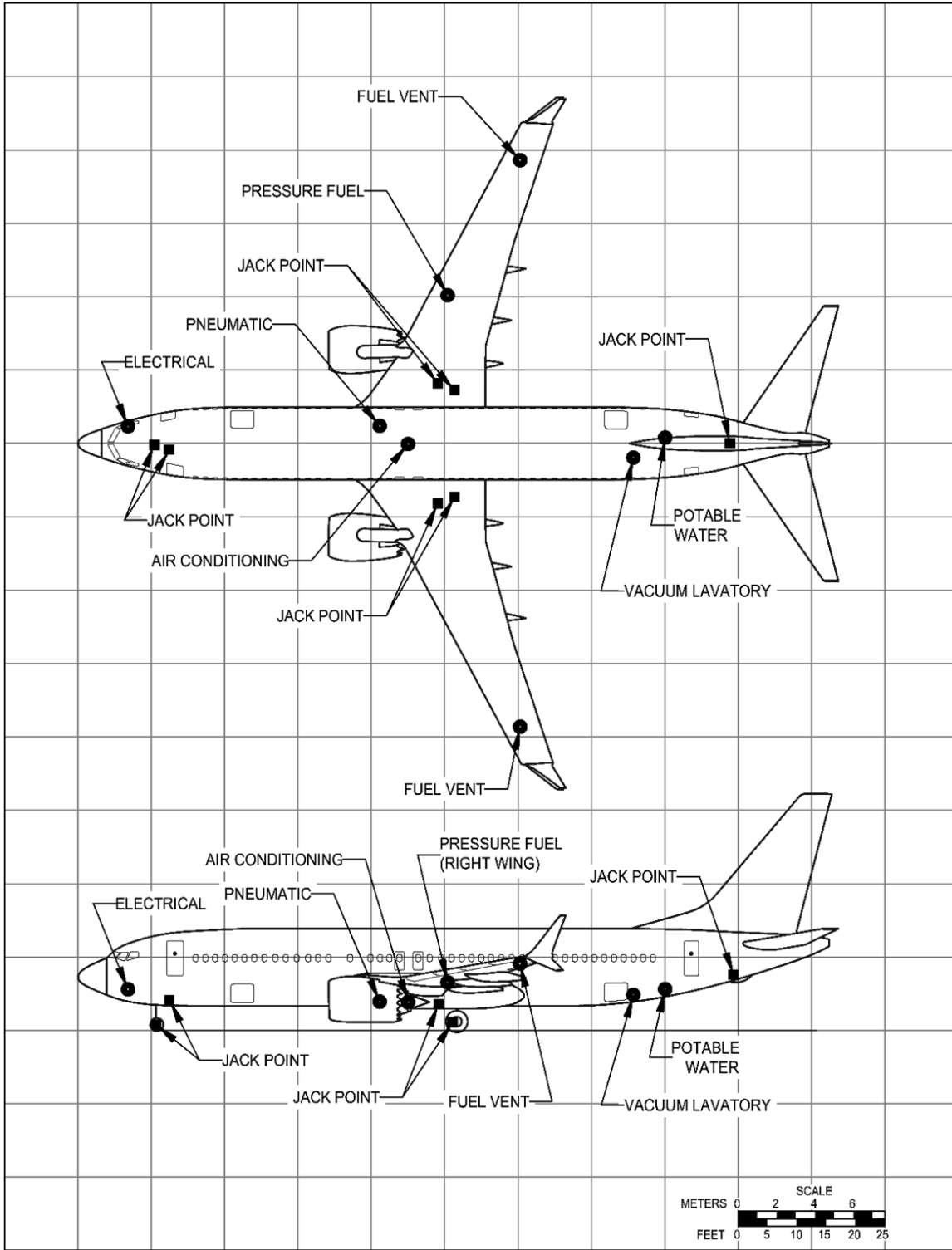

5.4.3 Ground Service Connections - Locations: Model 737-9

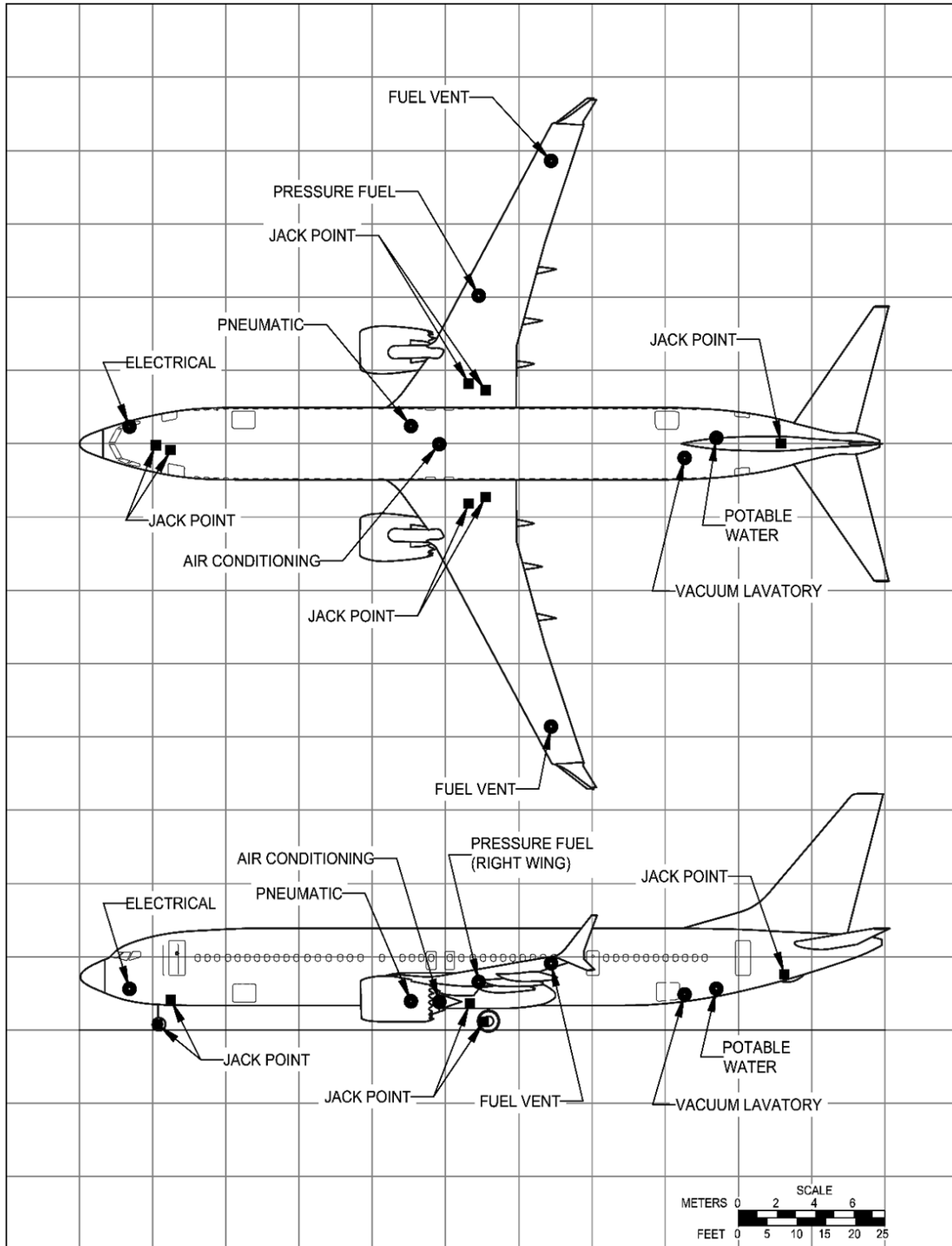

5.4.4 Ground Servicing Connections and Capacities: All Models

SYSTEM	MODEL *[1]	DISTANCE *[2] AFT OF		DISTANCE *[2] FROM AIRPLANE CENTERLINE				MAX HEIGHT *[2] ABOVE	
		NOSE		LH SIDE		RH SIDE		GROUND	
		FT-IN	M	FT-IN	M	FT-IN	M	FT-IN	M
CONDITIONED AIR ONE 8-IN (20.3 CM) PORT	737-7	42 - 3	12.9	0	0	0	0	4 - 5	1.3
	737-8	49 - 7	15.1	0	0	0	0	4 - 5	1.3
	737-9	54 - 9	16.7	0	0	0	0	4 - 5	1.3
ELECTRICAL ONE CONNECTION - 90 KVA, 115/200 VAC 400 HZ, 3-PHASE EACH	737-7	8 - 6	2.6	-	-	3 - 1	0.9	8 - 2	2.5
	737-8	8 - 6	2.6	-	-	3 - 1	0.9	8 - 2	2.5
	737-9	8 - 6	2.6	-	-	3 - 1	0.9	8 - 2	2.5
FUEL ONE UNDERWING- PRESSURE CONNECTOR ON RIGHT WING TOTAL CAPACITY 6,820 GAL (25,817 LITERS)	737-7	55 - 8	17.0	-	-	25 - 3	7.7	9 - 8	2.9
	737-8	63 - 0	19.2	-	-	25 - 3	7.7	9 - 8	2.9
	737-9	68 - 2	20.8	-	-	25 - 3	7.7	9 - 8	2.9
FUEL VENT FUEL VENT ON UNDERSIDE OF BOTH WINGTIPS	737-7	68 - 0	20.7	48 - 3	14.7	48 - 3	14.7	UNDERSIDE OF WING	
	737-8	75 - 4	22.0	48 - 3	14.7	48 - 3	14.7		
	737-9	80 - 6	24.5	48 - 3	14.7	48 - 3	14.7		
LAVATORY ONE CONNECTION FOR VACUUM LAVATORY	737-7	81 - 11	25.0	2 - 7	0.8	-	-	5 - 10	1.8
	737-8	94 - 9	28.9	2 - 7	0.8	-	-	5 - 10	1.8
	737-9	103 - 5	31.5	2 - 7	0.8	-	-	5 - 10	1.8
OXYGEN CREW INDIVIDUAL CANISTERS IN EACH PASSENGER SERVICE UNIT	737-7	18 - 11	5.8	-	-	0 - 10	0.3	7 - 0	2.1
	737-8	18 - 11	5.8	-	-	0 - 10	0.3	7 - 0	2.1
	737-9	18 - 11	5.8	-	-	0 - 10	0.3	7 - 0	2.1
PNEUMATIC ONE 3-IN (7.6-CM) PORT FOR ENGINE START AND AIRCONDITIONING PACKS	737-7	44 - 1	13.4	-	-	3 - 0	0.9		
	737-8	51 - 5	15.7	-	-	3 - 0	0.9	4 - 10	1.5
	737-9	56 - 7	17.2	-	-	3 - 0	0.9	4 - 10	1.5
POTABLE WATER ONE SERVICE CONNECTION 0.75-IN (1.9 CM)	737-7	87 - 3	26.6	-	-	1 - 0	0.3	6 - 3	1.9
	737-8	100 - 1	30.5	-	-	1 - 0	0.3	6 - 3	1.9
	737-9	108 - 9	33.1	-	-	1 - 0	0.3	6 - 3	1.9

NOTES:

*[1] 737-8 INCLUDES 737-8 / -8-200 / BBJ MAX 8

*[2] DISTANCES OR HEIGHTS ROUNDED TO THE NEAREST INCH AND 0.1 METER.

5.5 ENGINE STARTING PNEUMATIC REQUIREMENTS

5.5.1 Engine Start Pneumatic Requirements - Sea Level: All Models

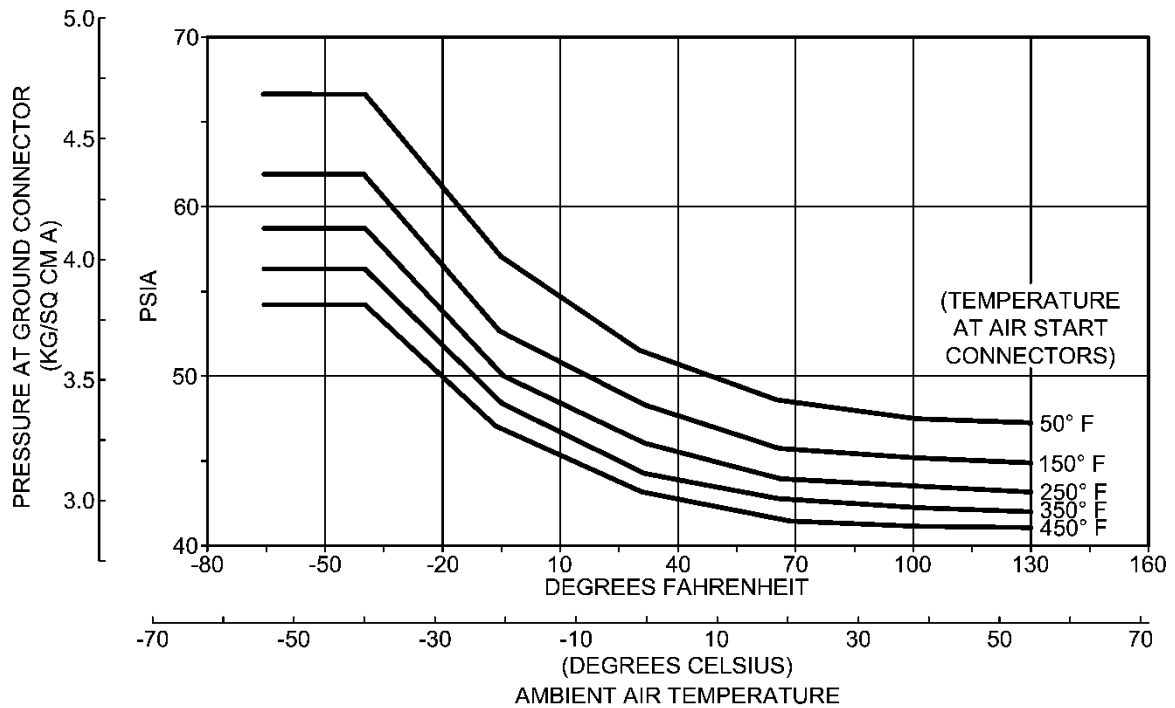
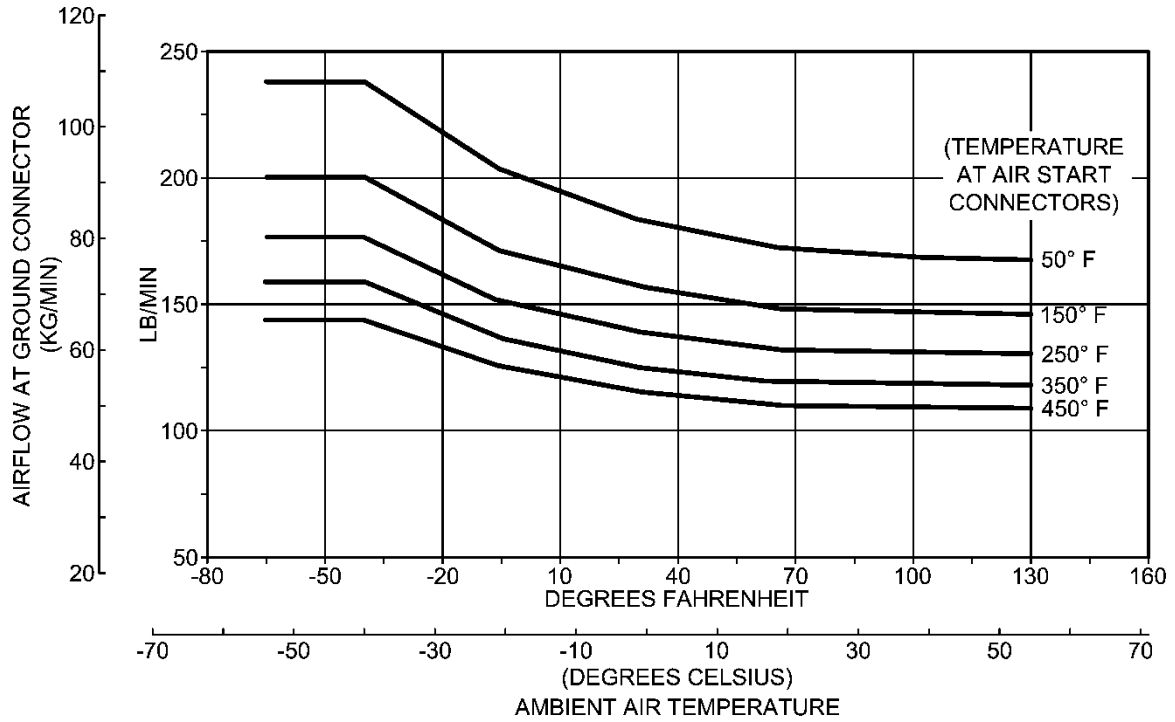

5.6 GROUND PNEUMATIC POWER REQUIREMENTS

5.6.1 Ground Pneumatic Power Requirements - Heating/Cooling: All Models

HEATING (PULL-UP)

- INITIAL CABIN TEMPERATURE: 0° F (-17.8° C)
- OUTSIDE AIR TEMPERATURE: 0° F (-17.8° C)
- NO GALLEY LOAD; NO ELECTRICAL LOAD

- $W_{CART} = 1.14 \times W$
- P = PRESSURE AT GROUND CONNECTION, PSIG
- TEMPERATURE AT GROUND CONNECTION: 200° F (93° C) TO 450° F (232° C)

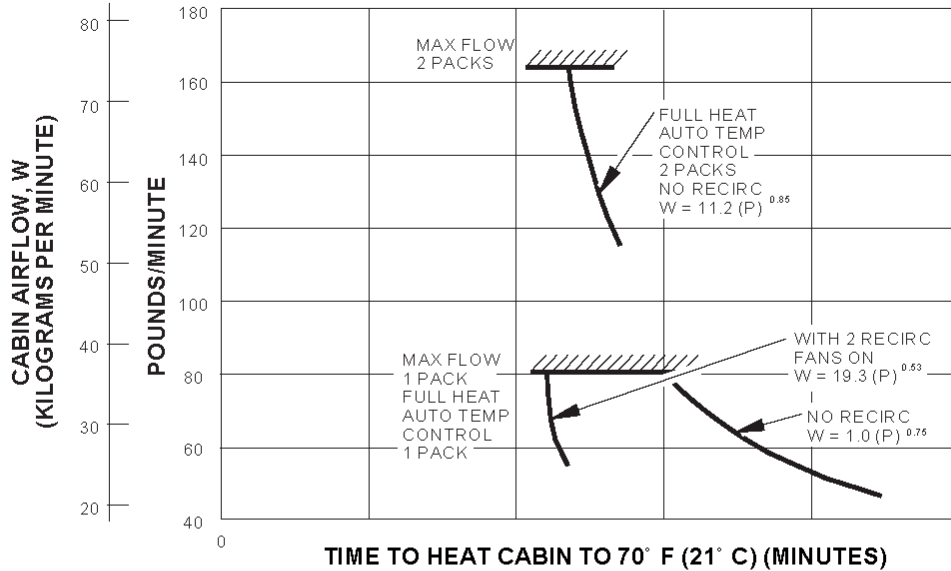

COOLING (PULL-DOWN)

- INITIAL CABIN TEMPERATURE: 103° F (39.5° C)
- OUTSIDE AIR TEMPERATURE: 103° F (39.5° C)
- SOLAR LOAD: 7,741 BTU/HR (195 KCAL/HR)

- NO GALLEY LOAD; NO ELECTRICAL LOAD
- TEMPERATURE AT GROUND CONNECTION: LESS THAN 450° F (232° C)
- $W_{CART} = 1.17 \times W$
- P = PRESSURE AT GROUND CONNECTION, PSIG

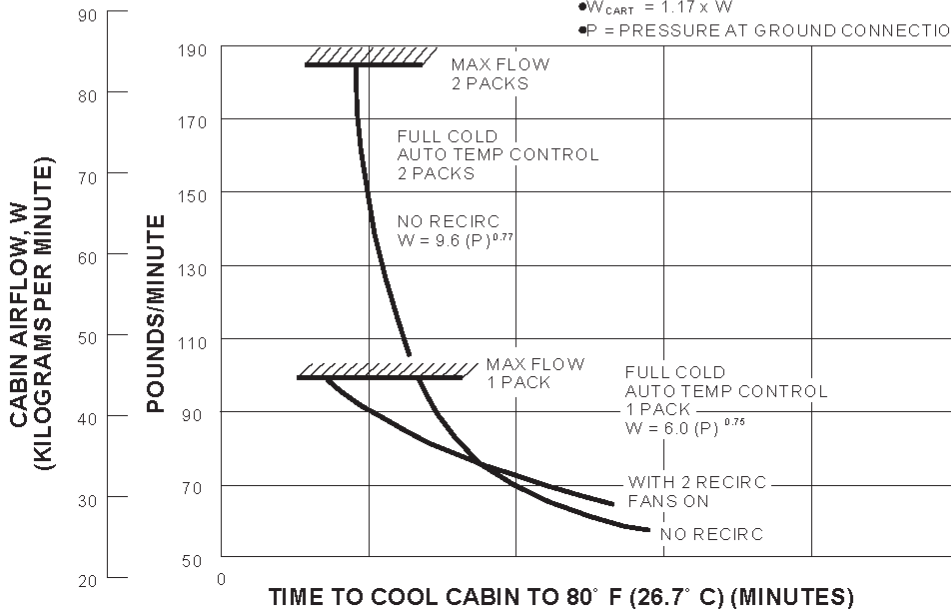

5.7 CONDITIONED AIR REQUIREMENTS

5.7.1 Conditioned Air Flow Requirements: All Models

COOLING:

- ① CABIN AT 75° F (23.9° C); 165 PASSENGERS AND CREW; NO GALLEY LOAD; SOLAR LOAD: 7,741 BTU/HR; ELECTRICAL LOAD: 10,955 BTU/HR
- ② CABIN AT 80° F (26.7° C); OTHERWISE SAME AS IN ①
- ③ CABIN AT 70° F (21.2° C); 2 CREW MEMBERS; GALLEY LOAD: 8,200 BTU/HR; SOLAR LOAD: 7,741 BTU/HR; ELECTRICAL LOAD: 10,955 BTU/HR
- ④ CABIN AT 80° F (26.7° C); 117 PASSENGERS AND CREW; NO GALLEY LOAD; BRIGHT DAY SOLAR LOAD: 7,741 BTU/HR; ELECTRICAL LOAD: 10,955 BTU/HR; PRECONDITIONED AIR PLANE

HEATING:

- ⑤ } CABIN AT 75° F (23.9° C); NO CREW OR PASSENGERS; NO OTHER HEAT LOAD
- ⑥ } CABIN AT 75° F (23.9° C); NO CREW OR PASSENGERS; NO OTHER HEAT LOAD
- ⑦ } CABIN AT 75° F (23.9° C); NO CREW OR PASSENGERS; NO OTHER HEAT LOAD
- ⑧ CABIN AT 75° F (23.9° C); 117 PASSENGERS AND CREW; NO GALLEY LOAD; ELECTRICAL LOAD: 10,955 BTU/HR; NO SOLAR LOAD.

ΔP_s = GAGE STATIC PRESSURE IN INCHES OF WATER AT GROUND CONNECTION
 1 BTU/UH = 0.252 KG-CAL/HR

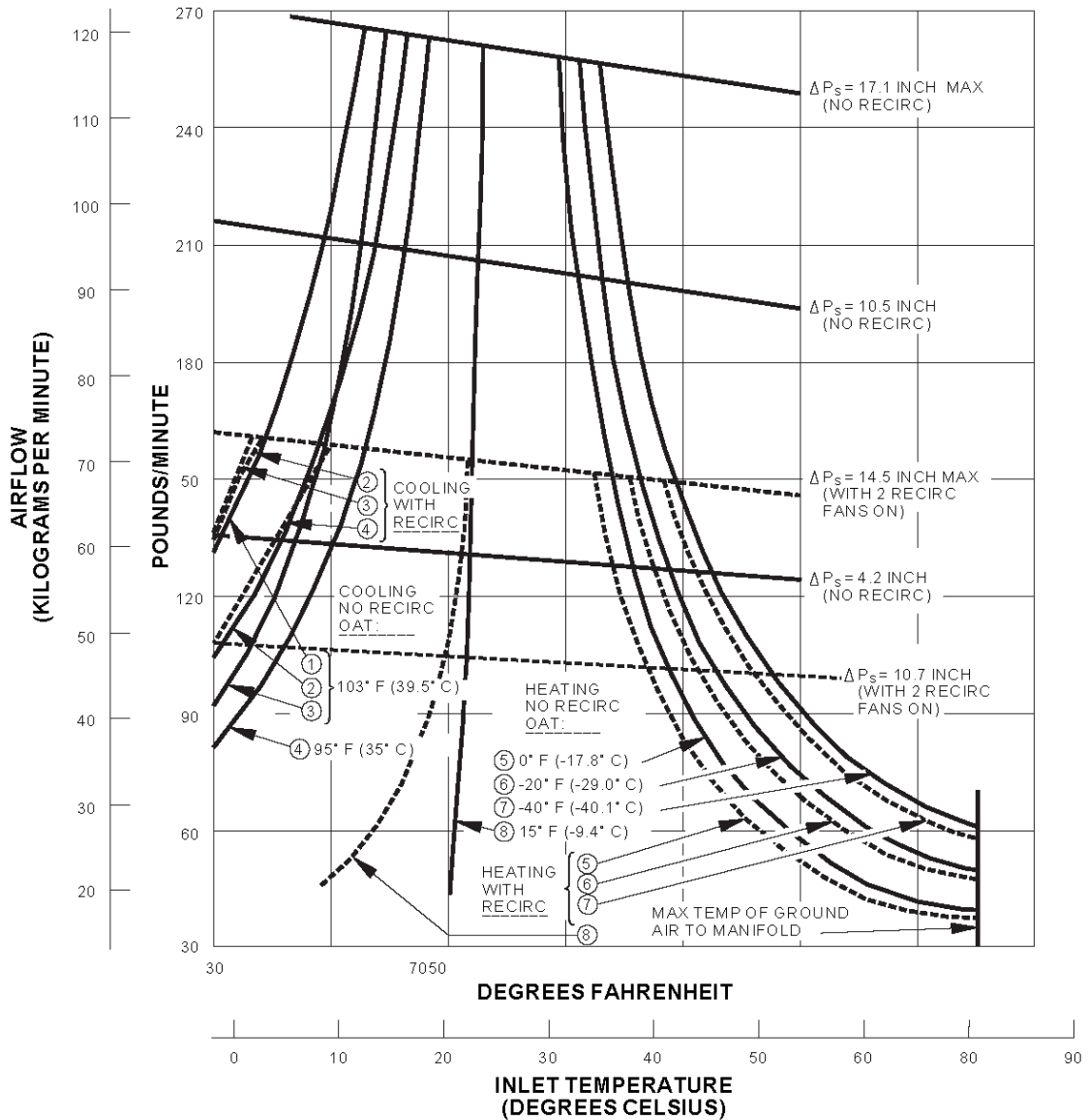

5.8 GROUND TOWING REQUIREMENTS

5.8.1 Ground Towing Requirements - English Units: All Models

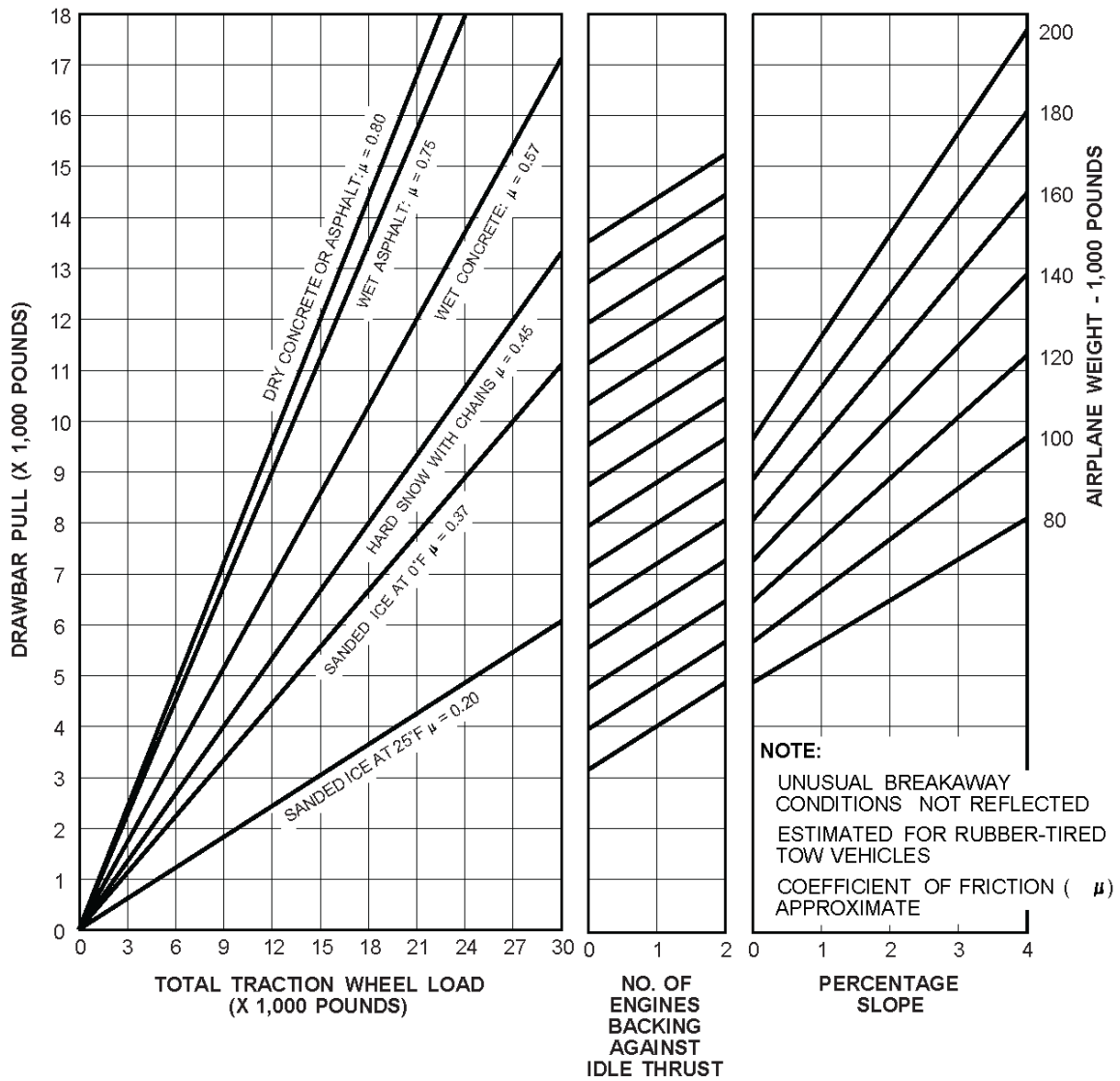

5.8.2 Ground Towing Requirements - Metric Units: All Models

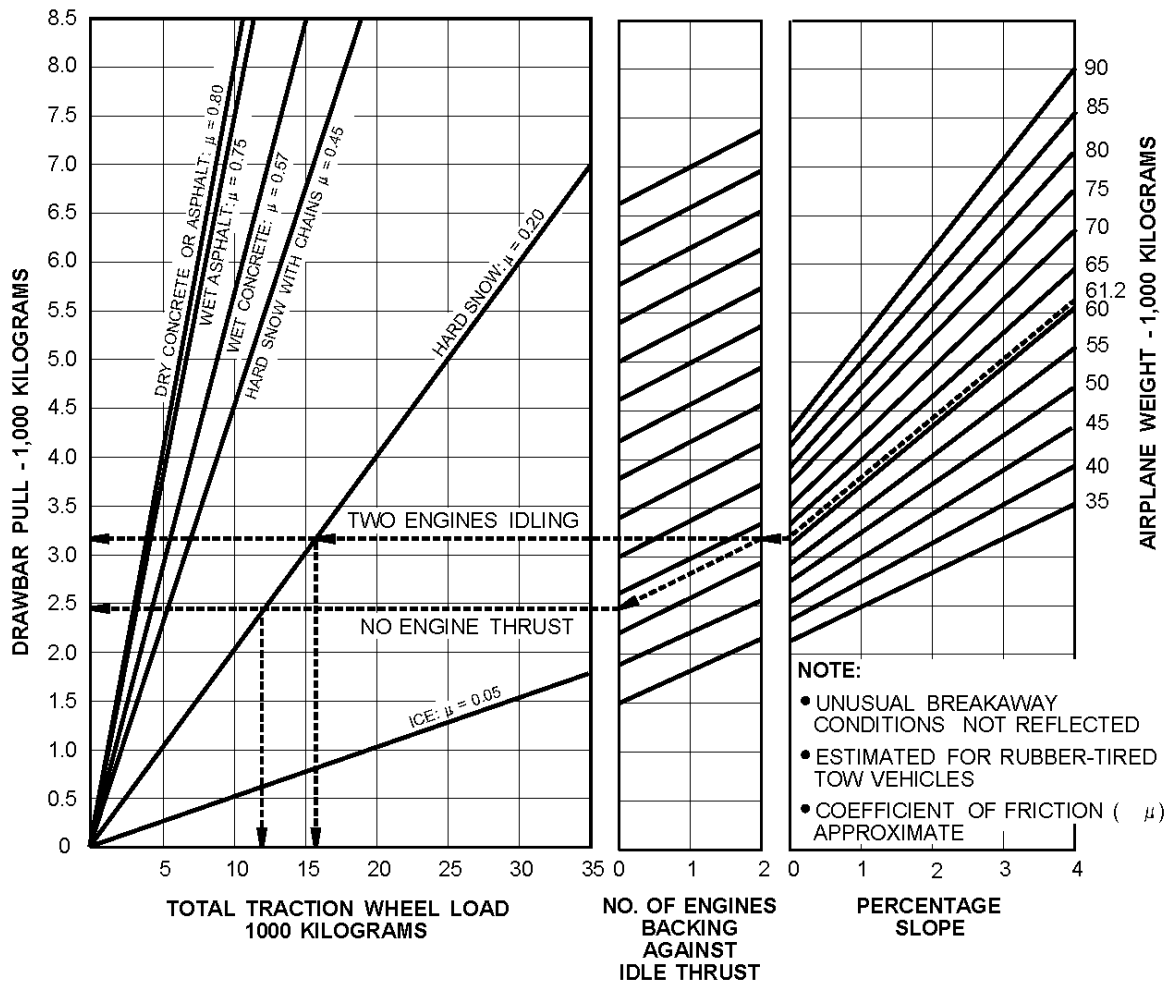

6.0 JET ENGINE WAKE AND NOISE DATA

6.1 JET ENGINE EXHAUST VELOCITIES AND TEMPERATURES

This section shows jet engine exhaust velocity and temperature contours aft of the 737 MAX family of airplanes. The contours were calculated from a standard computer analysis using three-dimensional viscous flow equations with mixing of primary, fan, and free-stream flow. The presence of the ground plane is included in the calculations as well as engine tilt and toe-in. Mixing of flows from the engines is also calculated. The analysis does not include thermal buoyancy effects which tend to elevate the jet wake above the ground plane. The buoyancy effects are considered to be small relative to the exhaust velocity and therefore are not included.

The graphs show jet wake velocity and temperature contours for representative engines. The results are valid for sea level, static, standard day conditions. The effect of wind on jet wakes is not included. There is evidence to show that a downwind or an upwind component does not simply add or subtract from the jet wake velocity, but rather carries the whole envelope in the direction of the wind. Crosswinds may carry the jet wake contour far to the side at large distances behind the airplane.

It should be understood, these exhaust velocity contours reflect steady-state, at maximum taxi weight, and not transient-state exhaust velocities. A steady-state is achieved with the aircraft in a fixed location, engine running at a given thrust level and measured when the contours stop expanding and stabilize in size, which could take several seconds. The steady-state condition, therefore, is conservative. Contours shown also do not account for performance variables such as ambient temperature or field elevation. For the terminal area environment, the transient-state is a more accurate representation of the actual exhaust contours when the aircraft is in motion and encountering static air with forward or turning movement, but it is very difficult to model on a consistent basis due to aircraft weight, weather conditions, the high degree of variability in terminal and apron configurations, and intensive numerical calculations. If the contours presented here are overly restrictive for terminal operations, The Boeing Company recommends conducting an analysis of the actual exhaust contours experienced by the using aircraft at the airport.

6.1.1 Jet Engine Exhaust Velocity Contours - Idle Thrust: Model 737-7

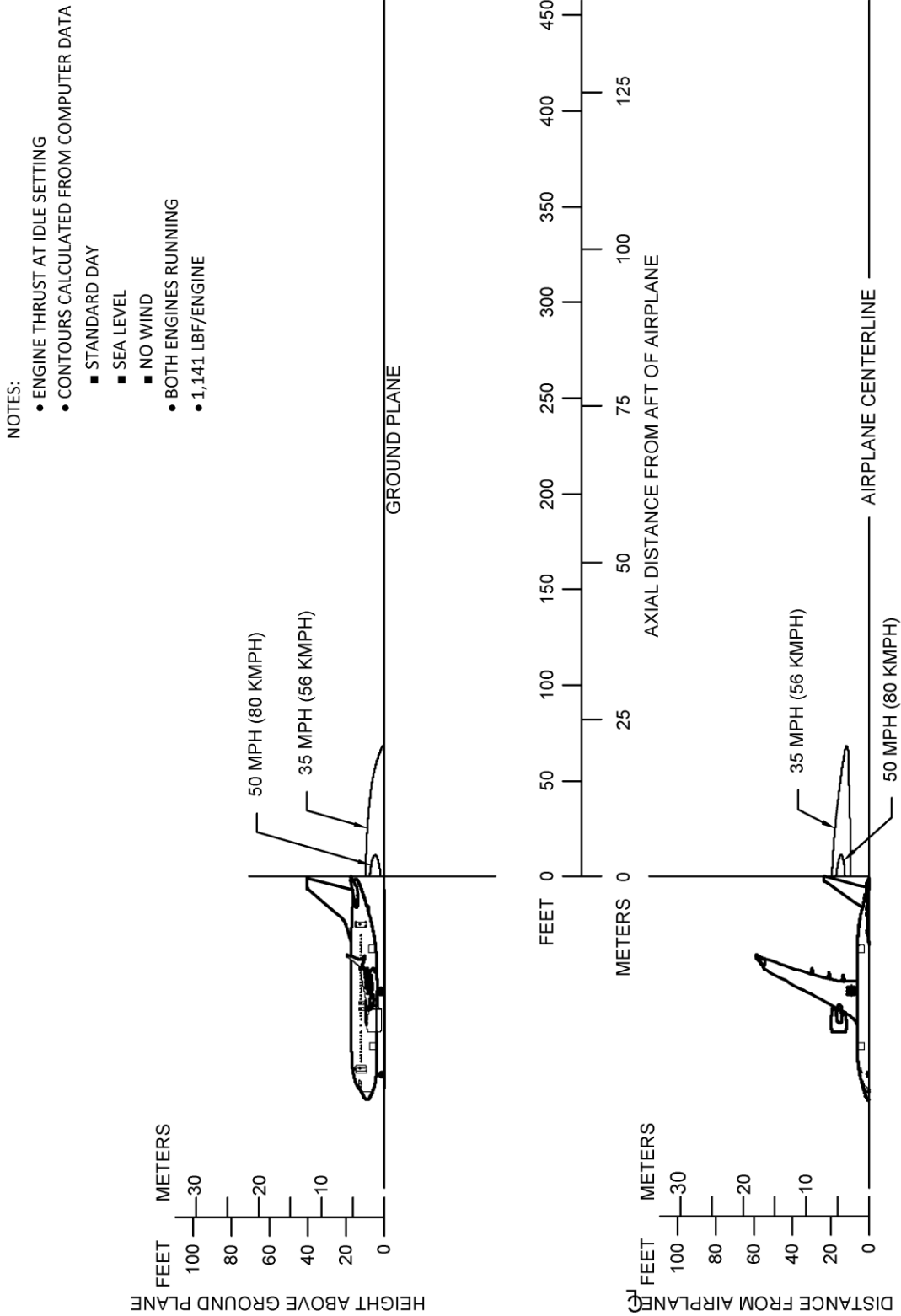

6.1.2 Jet Engine Exhaust Velocity Contours - Breakaway Thrust / 0% Slope / Both Engines / MTW: Model 737-7

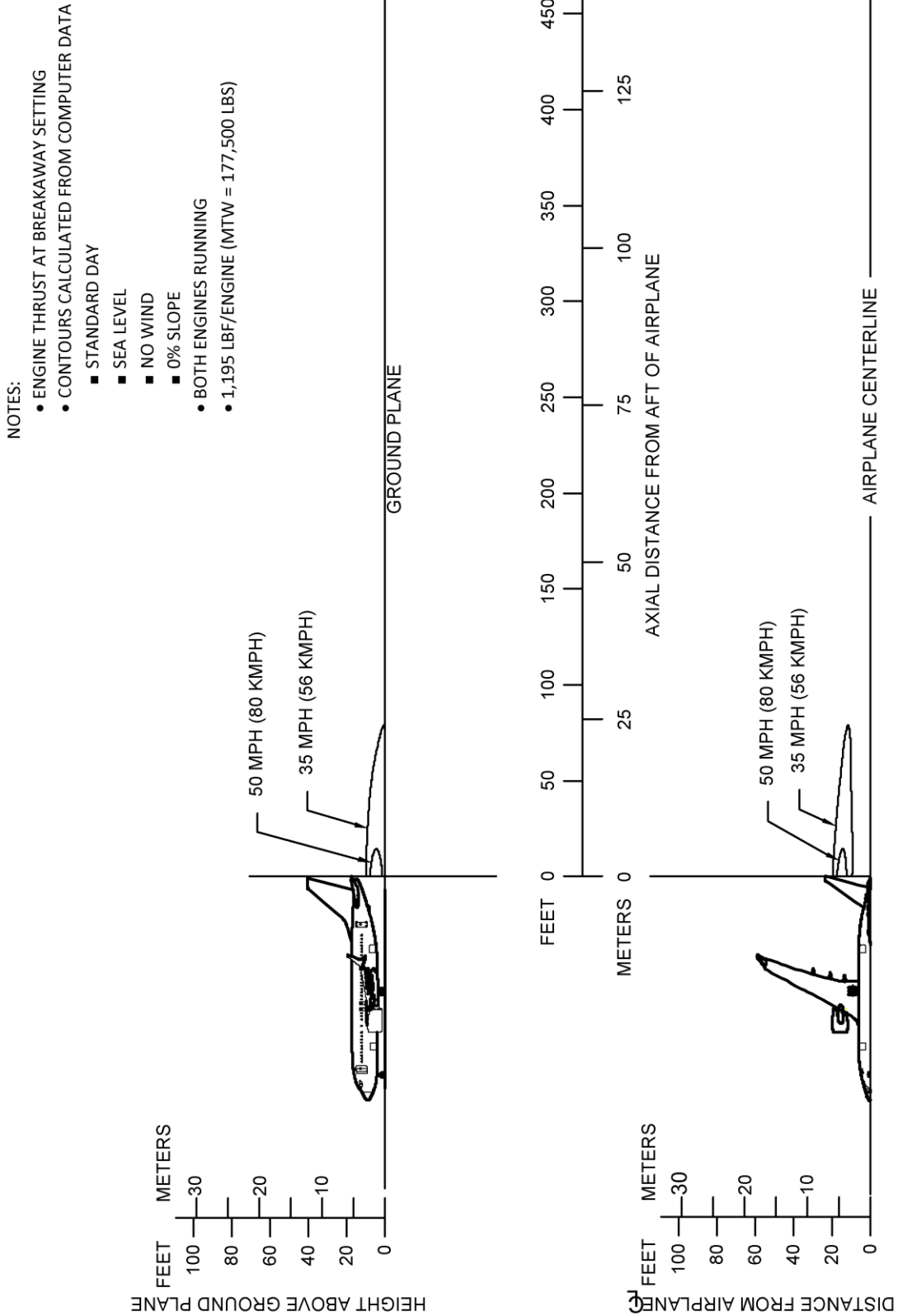

6.1.3 Jet Engine Exhaust Velocity Contours - Breakaway Thrust / 1% Slope / Both Engines / MTW: Model 737-7

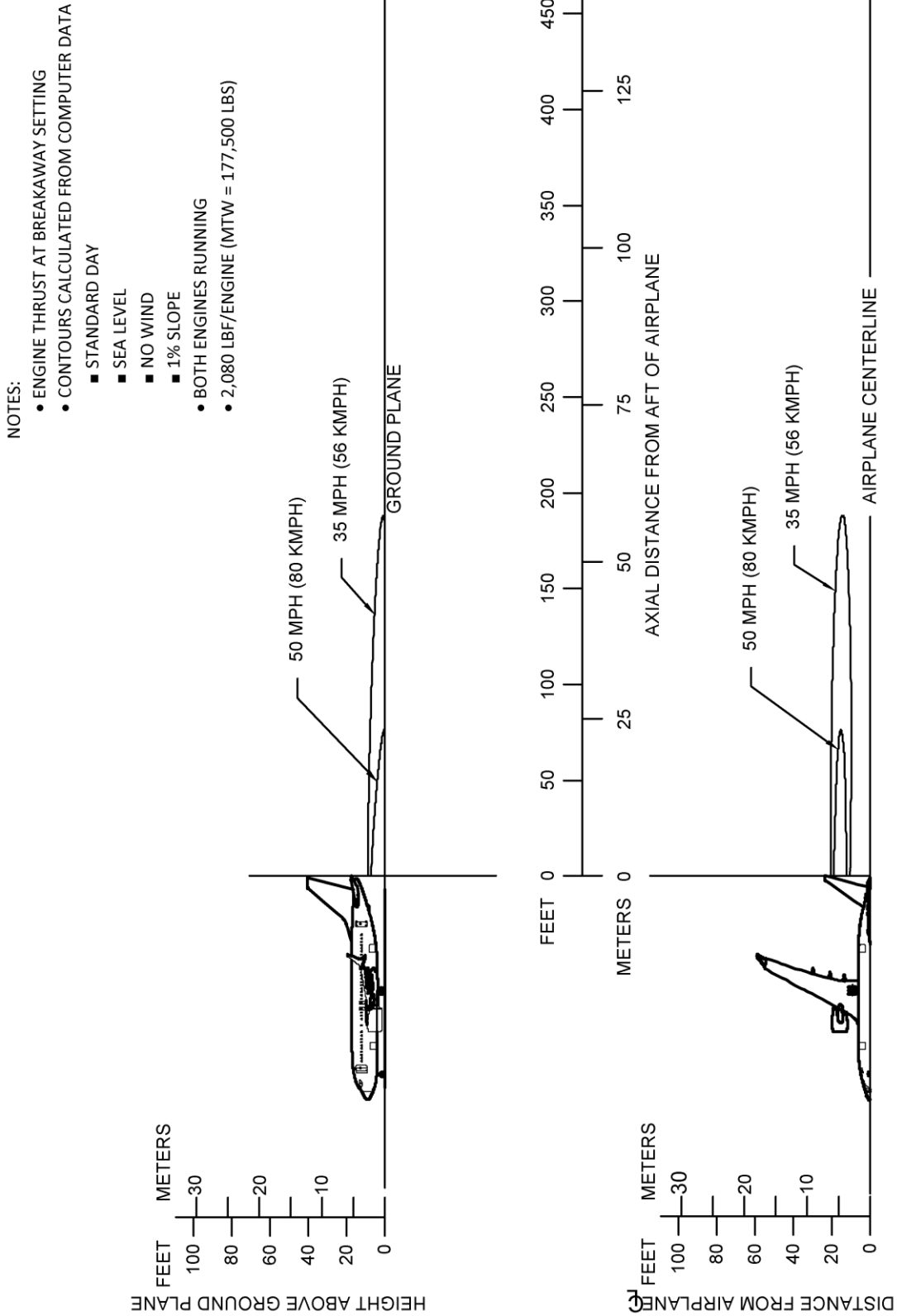

6.1.4 Jet Engine Exhaust Velocity Contours - Breakaway Thrust / 0% Slope / Single Engine / MTW: Model 737-7

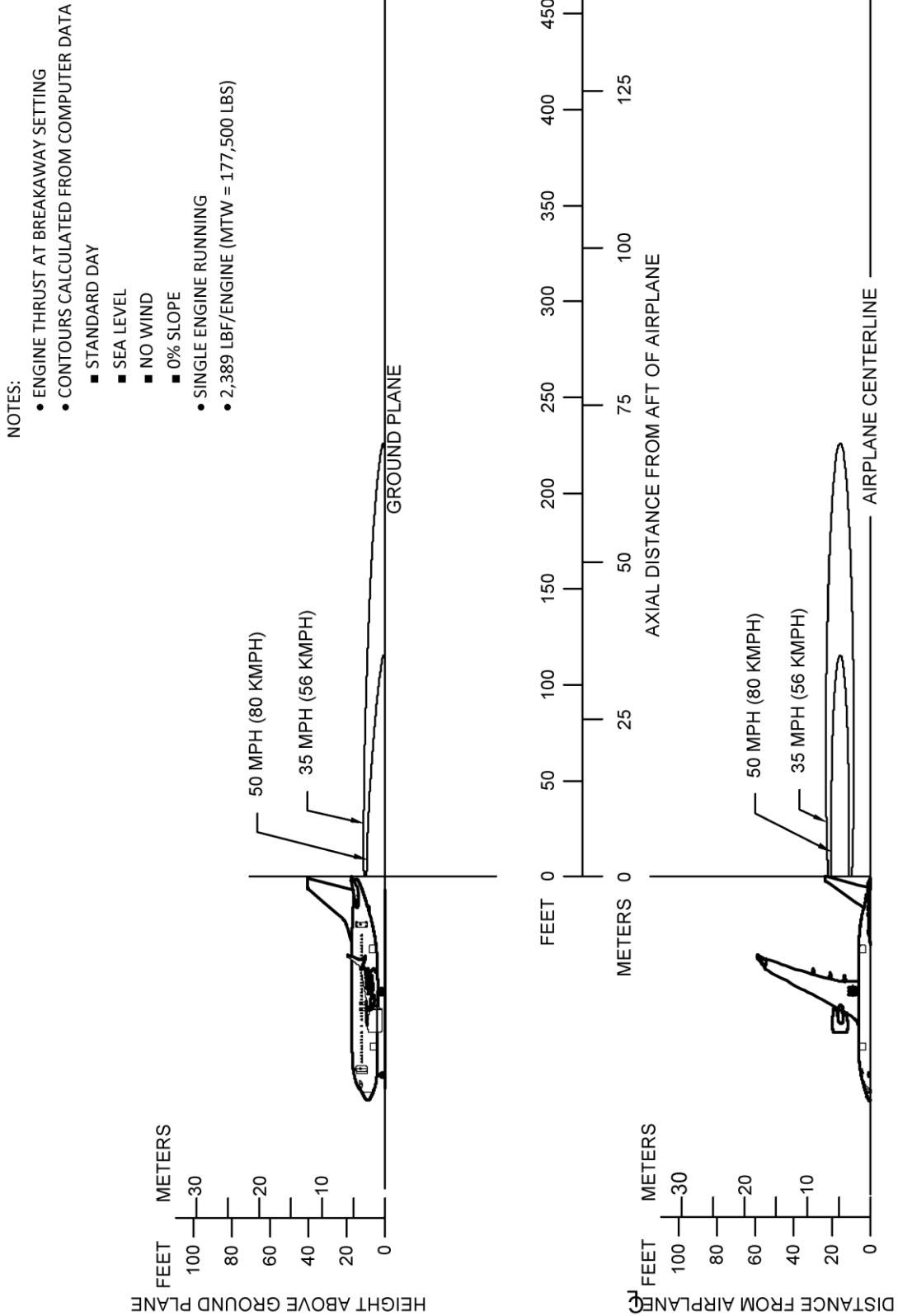

6.1.5 Jet Engine Exhaust Velocity Contours - Breakaway Thrust / 0% Slope / Single Engine / MLW: Model 737-7

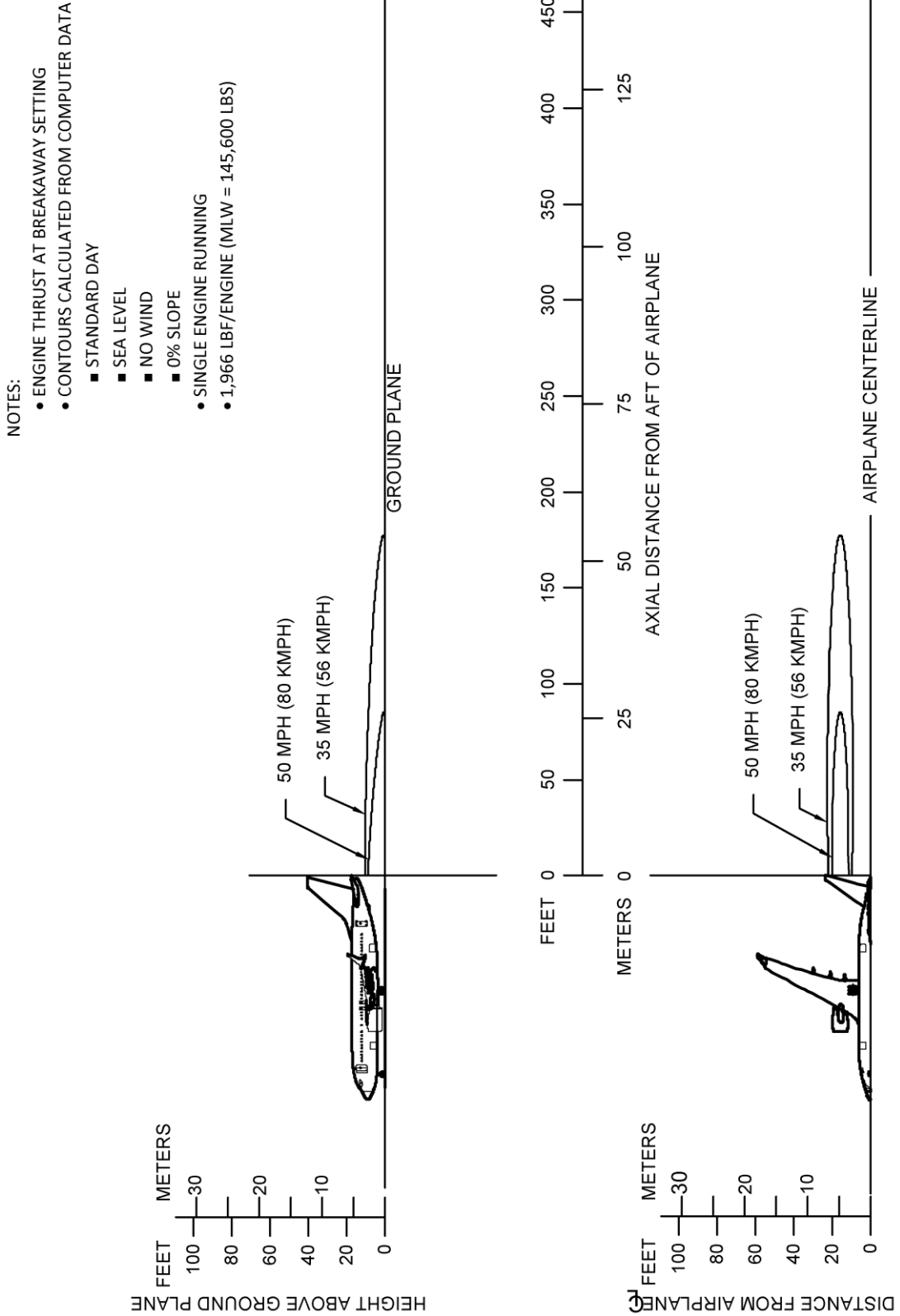

6.1.6 Jet Engine Exhaust Velocity Contours - Takeoff Thrust: Model 737-7

- NOTES:
- ENGINE THRUST AT TAKEOFF SETTING
 - CONTOURS CALCULATED FROM COMPUTER DATA
 - STANDARD DAY
 - SEA LEVEL
 - NO WIND
 - BOTH ENGINES RUNNING
 - 27,658 LBF/ENGINE

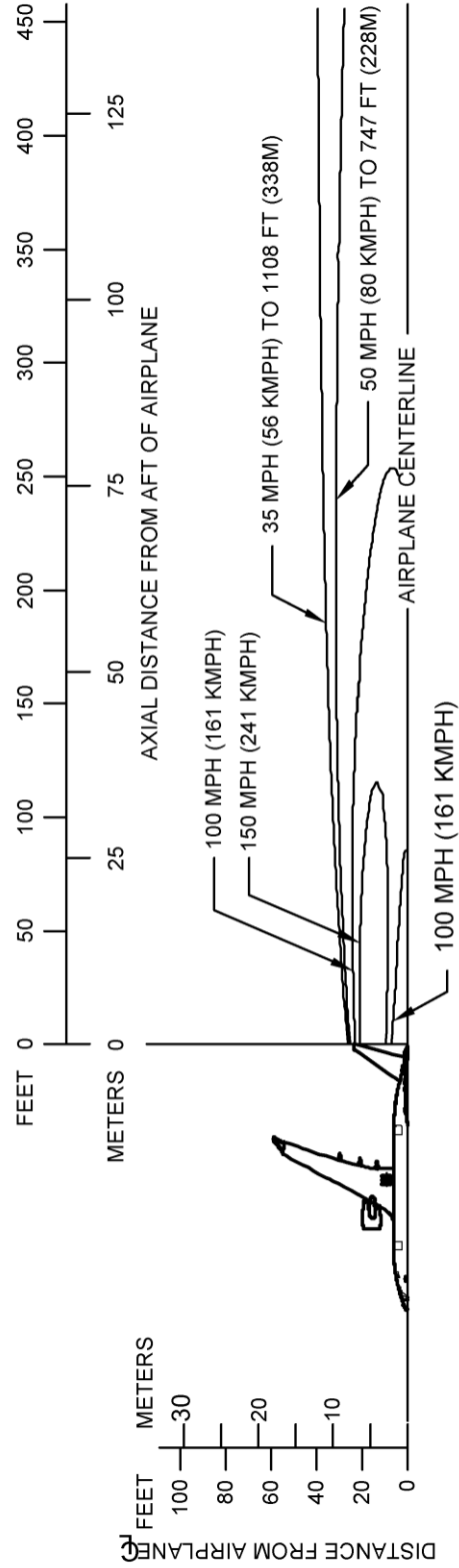
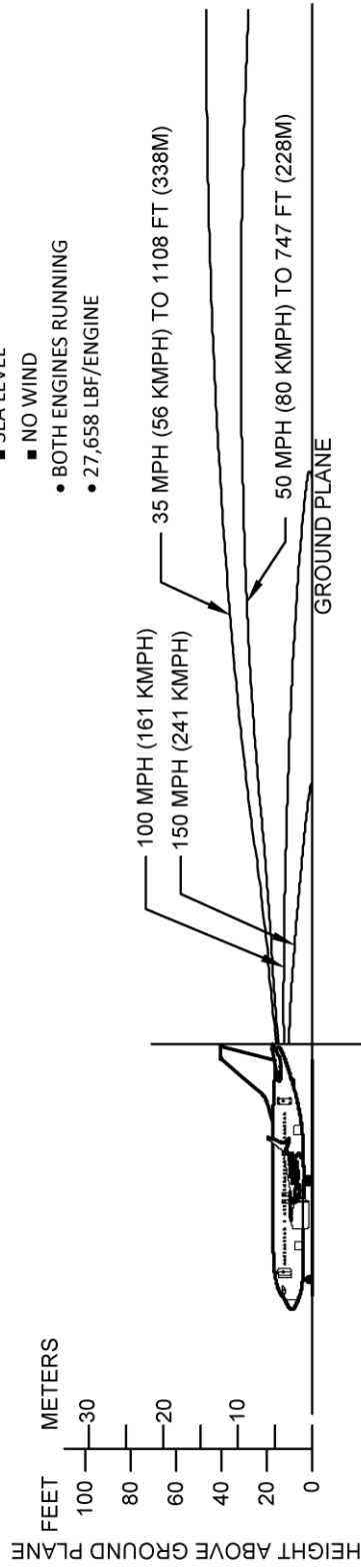

**6.1.7 Jet Engine Exhaust Temperature Contours – Idle/Breakaway Thrust:
Model 737-7**

Temperature contours for idle/breakaway power conditions are not shown as the maximum temperature aft of the 737-7 is predicated to be less than 100° F (38° C) for standard day conditions of 59° F (15° C).

6.1.8 Jet Engine Exhaust Temperature Contours – Takeoff Thrust: Model 737-7

- NOTES:
- ENGINE THRUST AT TAKEOFF SETTING
 - CONTOURS CALCULATED FROM COMPUTER DATA
 - STANDARD DAY
 - SEA LEVEL
 - NO WIND
 - BOTH ENGINES RUNNING
 - 27,658 LBF/ENGINE

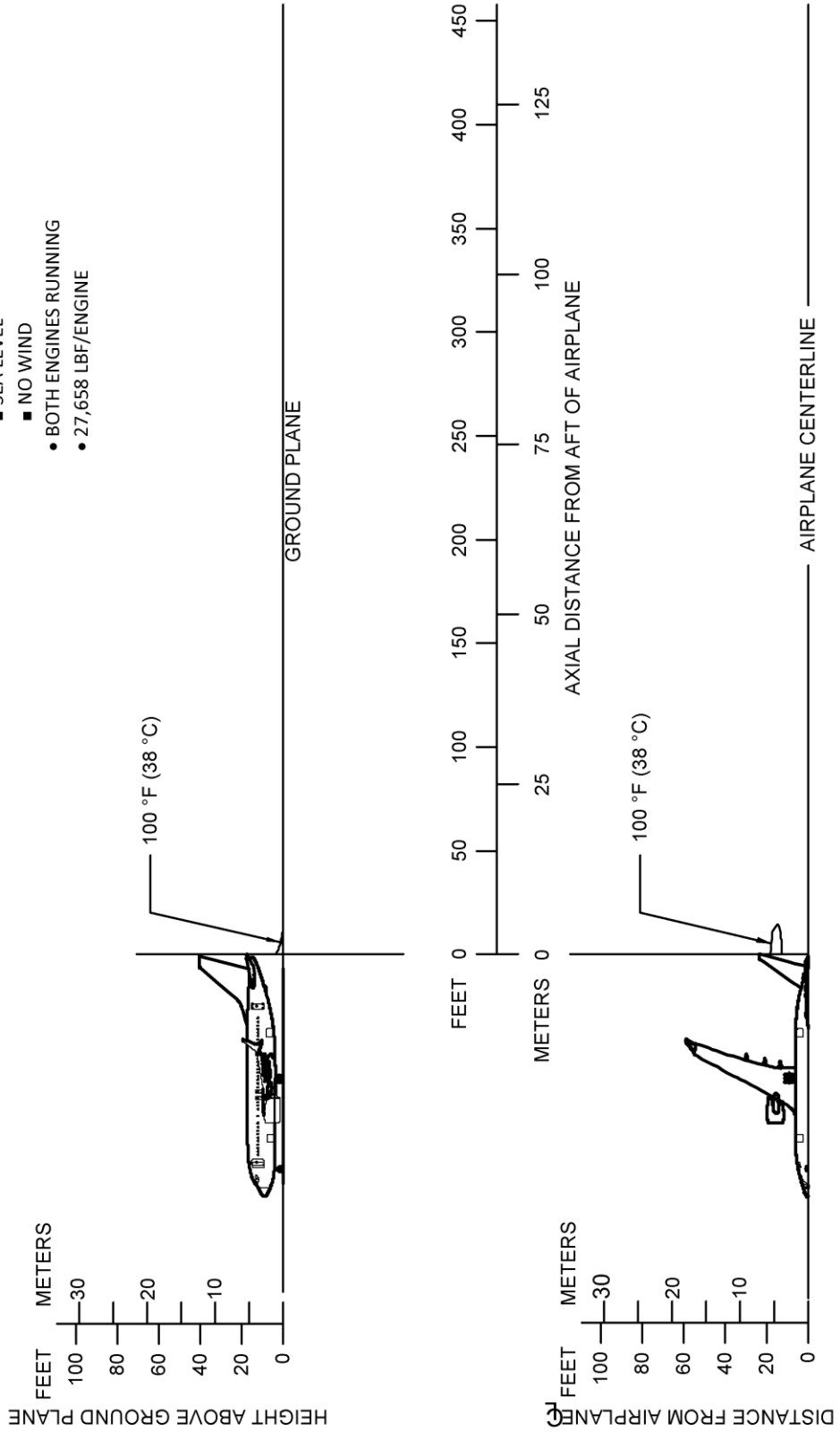

6.1.9 Jet Engine Exhaust Velocity Contours - Idle Thrust: Model 737-8 / -8-200 / BBJ MAX 8

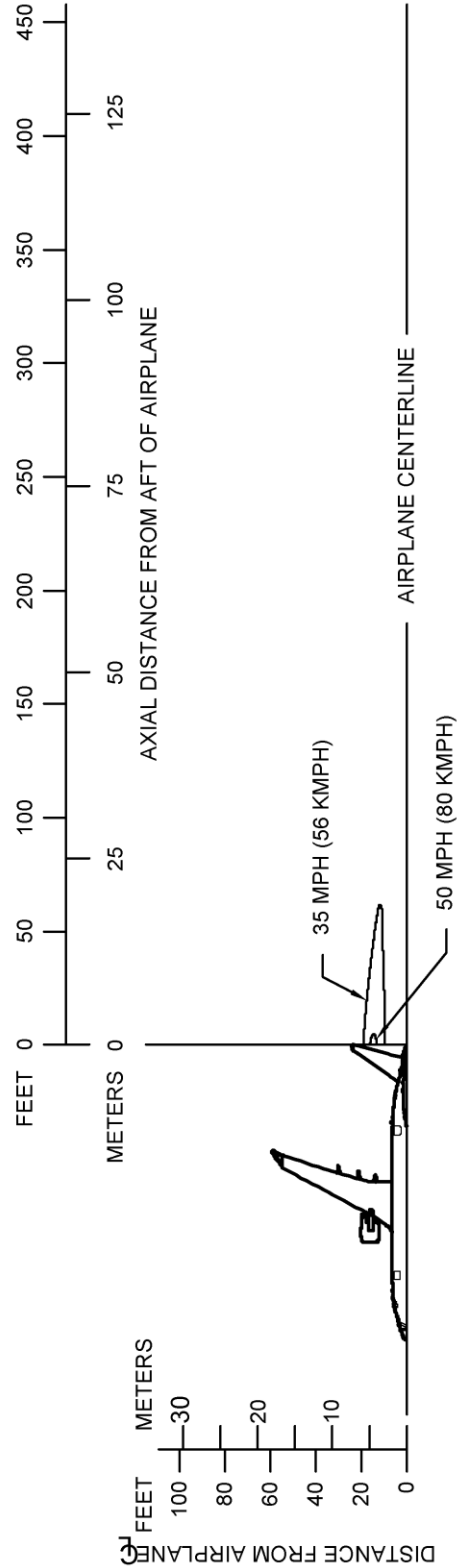
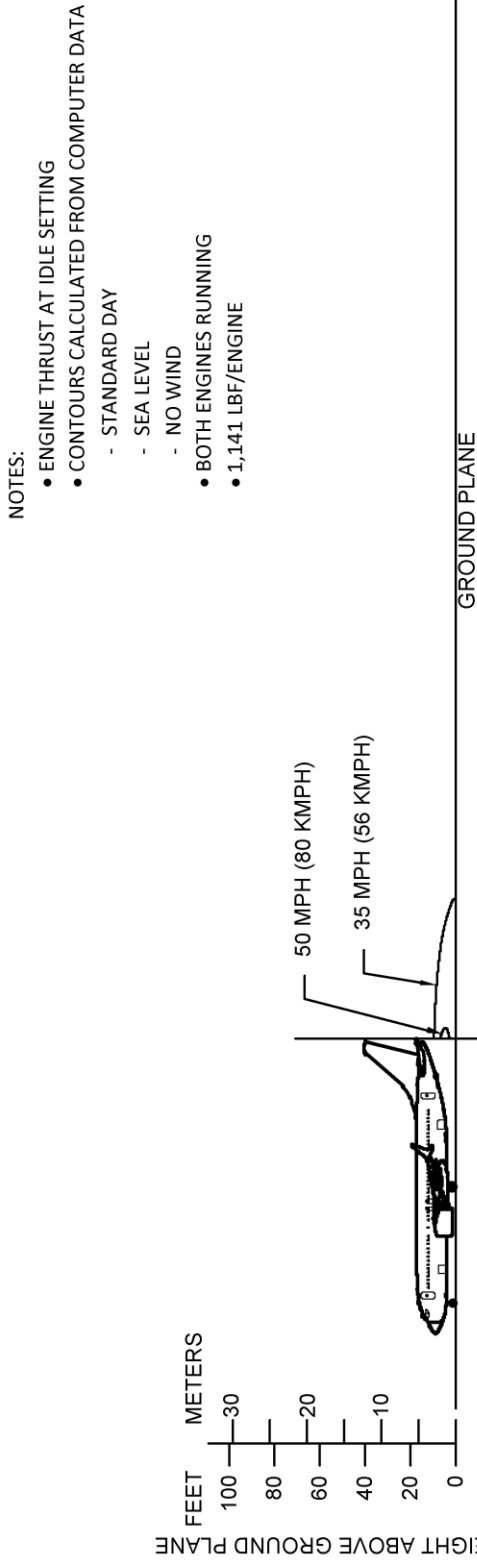

6.1.10 Jet Engine Exhaust Velocity Contours - Breakaway Thrust / 0% Slope / Both Engines / MTW: Model 737-8 / -8-200 / BBJ MAX 8

- NOTES:
- ENGINE THRUST AT BREAKAWAY SETTING
 - CONTOURS CALCULATED FROM COMPUTER DATA
 - STANDARD DAY
 - SEA LEVEL
 - NO WIND
 - 0% SLOPE
 - BOTH ENGINES RUNNING
 - 1,227 LBF/ENGINE (MTW = 181,700 LBS)

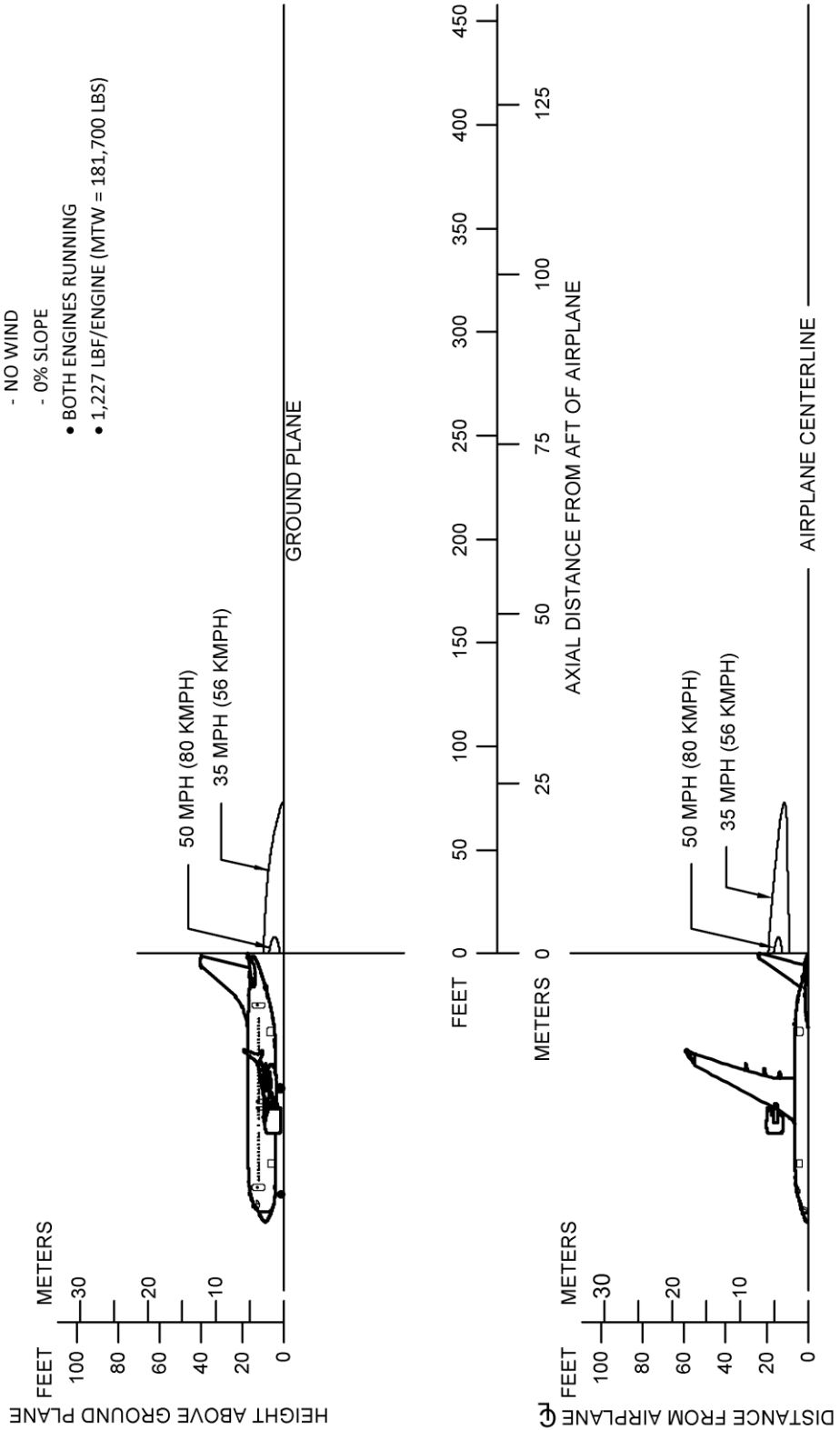

6.1.11 Jet Engine Exhaust Velocity Contours - Breakaway Thrust / 1% Slope / Both Engines / MTW: Model 737-8 / -8-200 / BBJ MAX 8

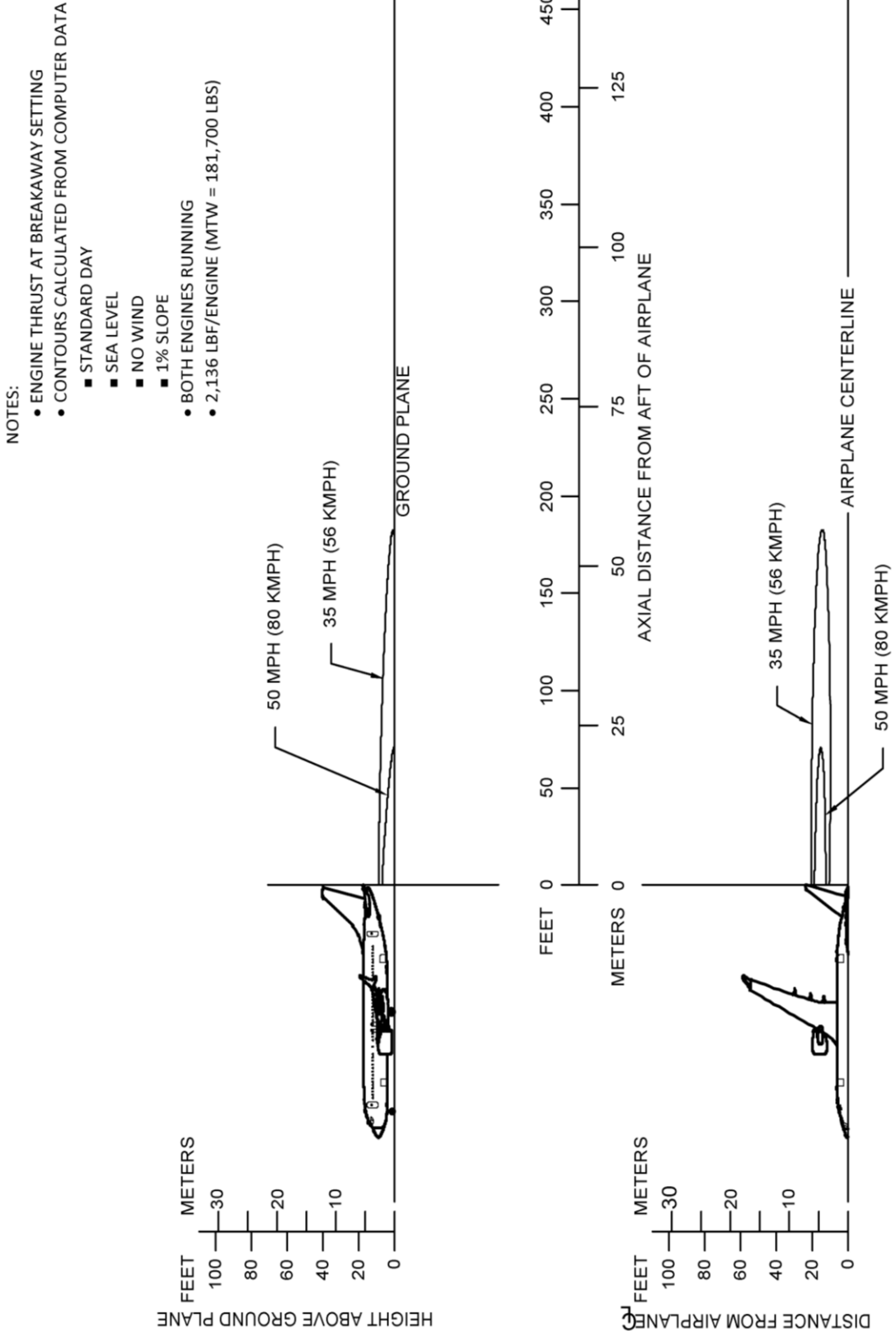

6.1.12 Jet Engine Exhaust Velocity Contours - Breakaway Thrust / 0% Slope / Single Engine / MTW: Model 737-8 / -8-200 / BBJ MAX 8

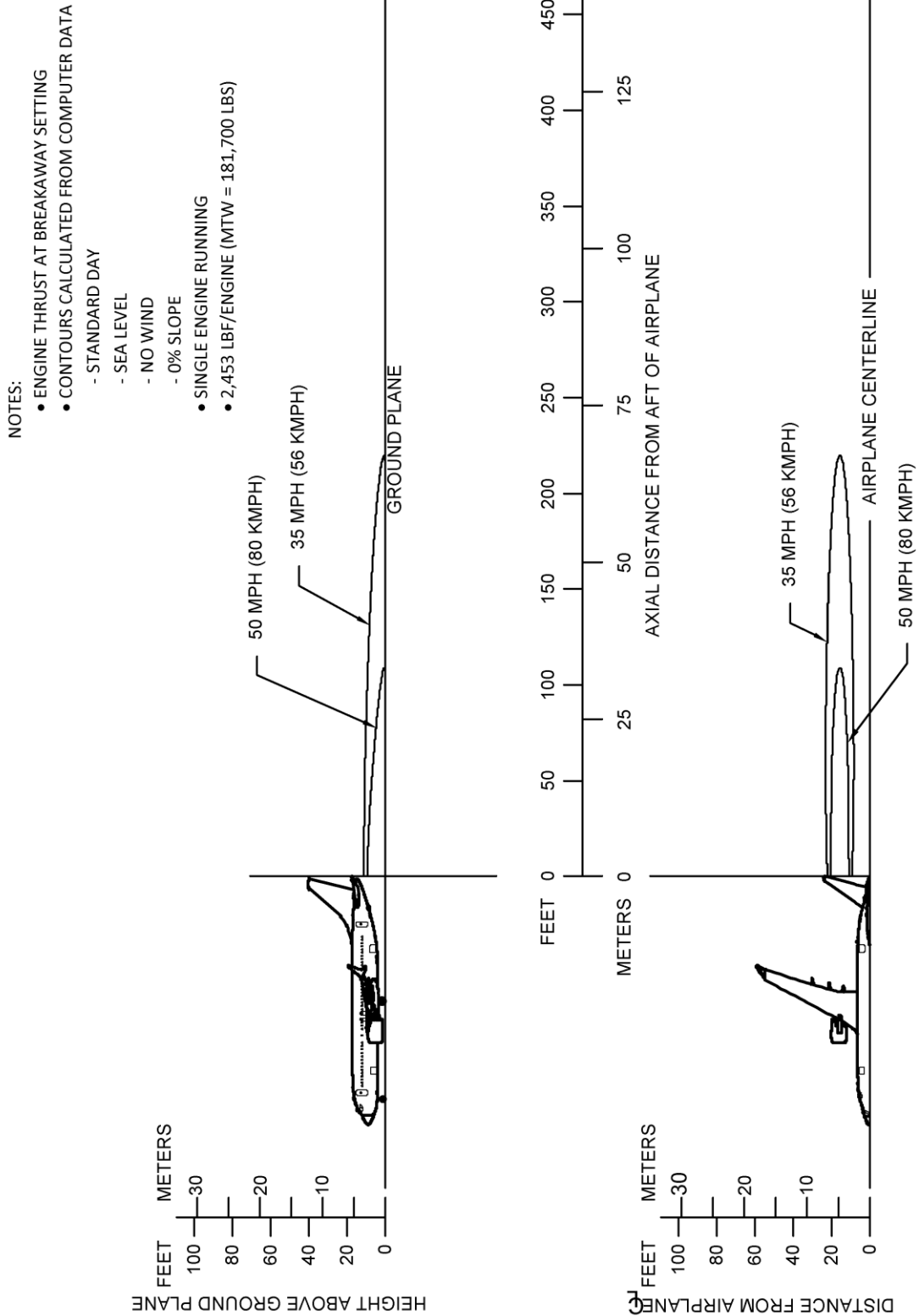

6.1.13 Jet Engine Exhaust Velocity Contours - Breakaway Thrust / 0% Slope / Single Engine / MLW: Model 737-8 / -8-200 / BBJ MAX 8

- NOTES:
- ENGINE THRUST AT BREAKAWAY SETTING
 - CONTOURS CALCULATED FROM COMPUTER DATA

- STANDARD DAY
- SEA LEVEL
- NO WIND
- 0% SLOPE

- SINGLE ENGINE RUNNING
- 2,049 LBF/ENGINE (MLW=152,800 LBS)

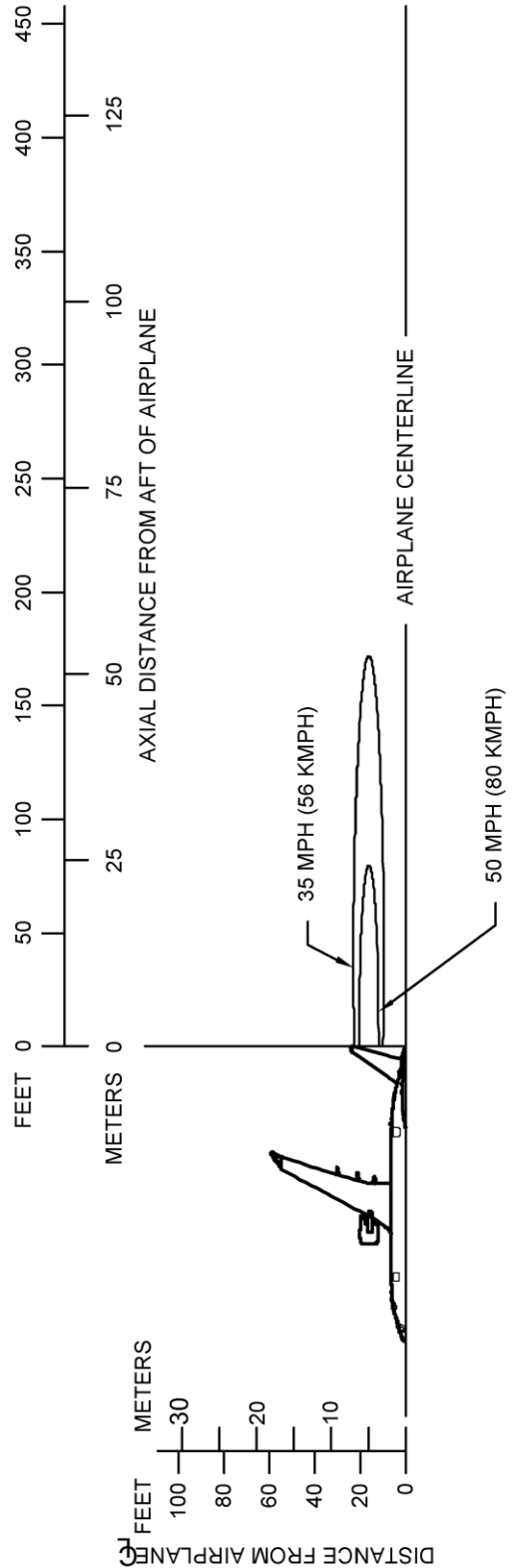
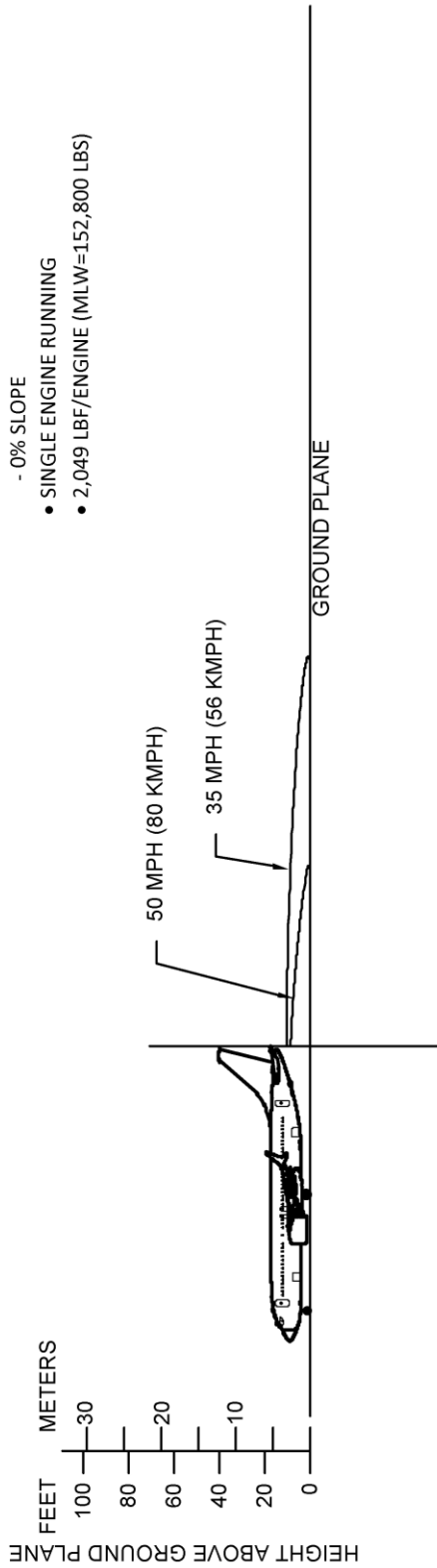

6.1.14 Jet Engine Exhaust Velocity Contours - Takeoff Thrust: Model 737-8 / -8-200 / BBJ MAX 8

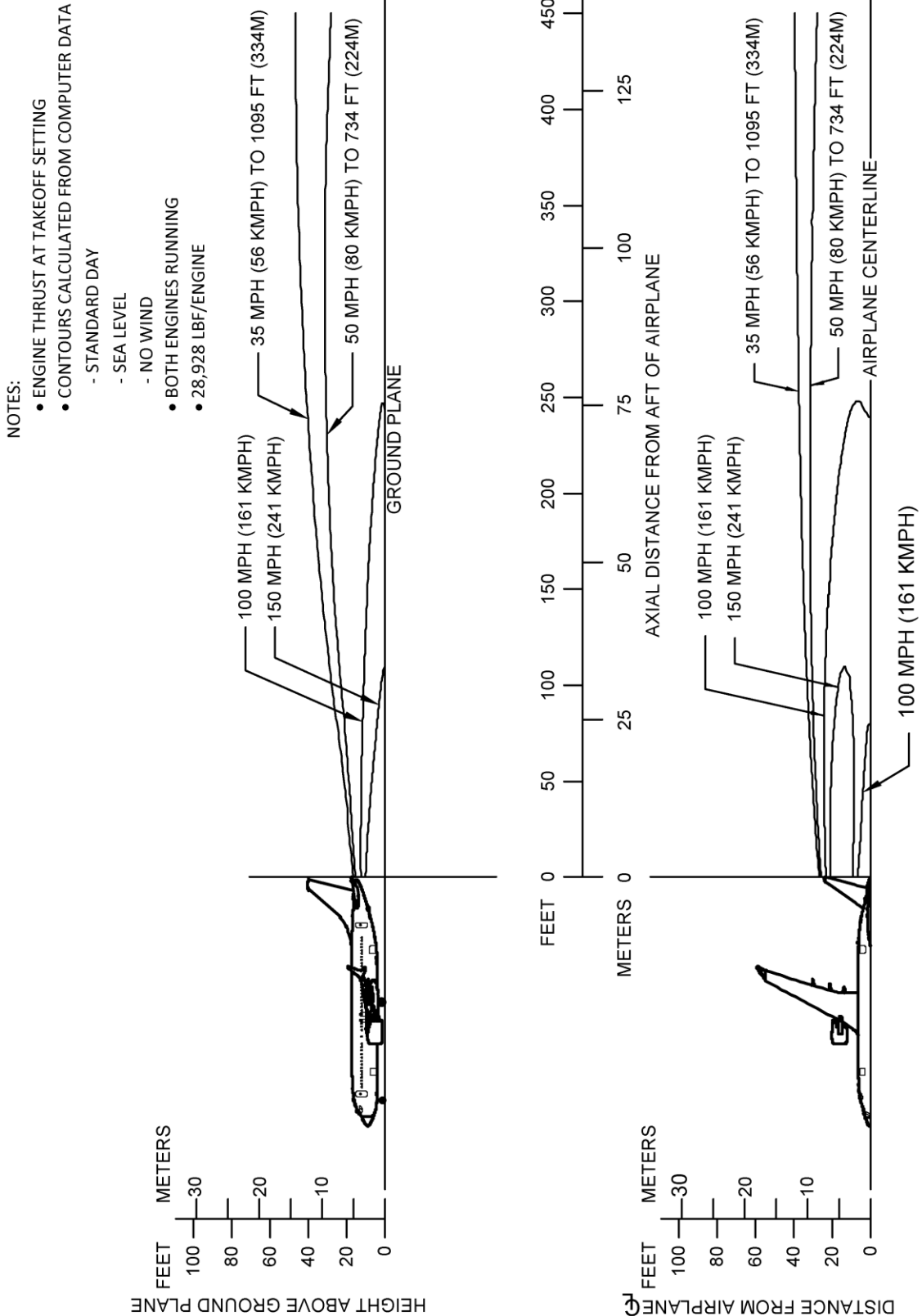

**6.1.15 Jet Engine Exhaust Temperature Contours – Idle/Breakaway Thrust:
Model 737-8 / -8-200 / BBJ MAX 8**

Temperature contours for idle/breakaway power conditions are not shown as the maximum temperature aft of the 737-8 / -8-200 / BBJ MAX 8 is predicated to be less than 100° F (38° C) for standard day conditions of 59° F (15° C).

6.1.16 Jet Engine Exhaust Temperature Contours – Takeoff Thrust: Model 737-8 / -8-200 / BBJ MAX 8

- NOTES:
- ENGINE THRUST AT TAKEOFF SETTING
 - CONTOURS CALCULATED FROM COMPUTER DATA
 - STANDARD DAY
 - SEA LEVEL
 - NO WIND
 - BOTH ENGINES RUNNING
 - 28,928 LBF/ENGINE

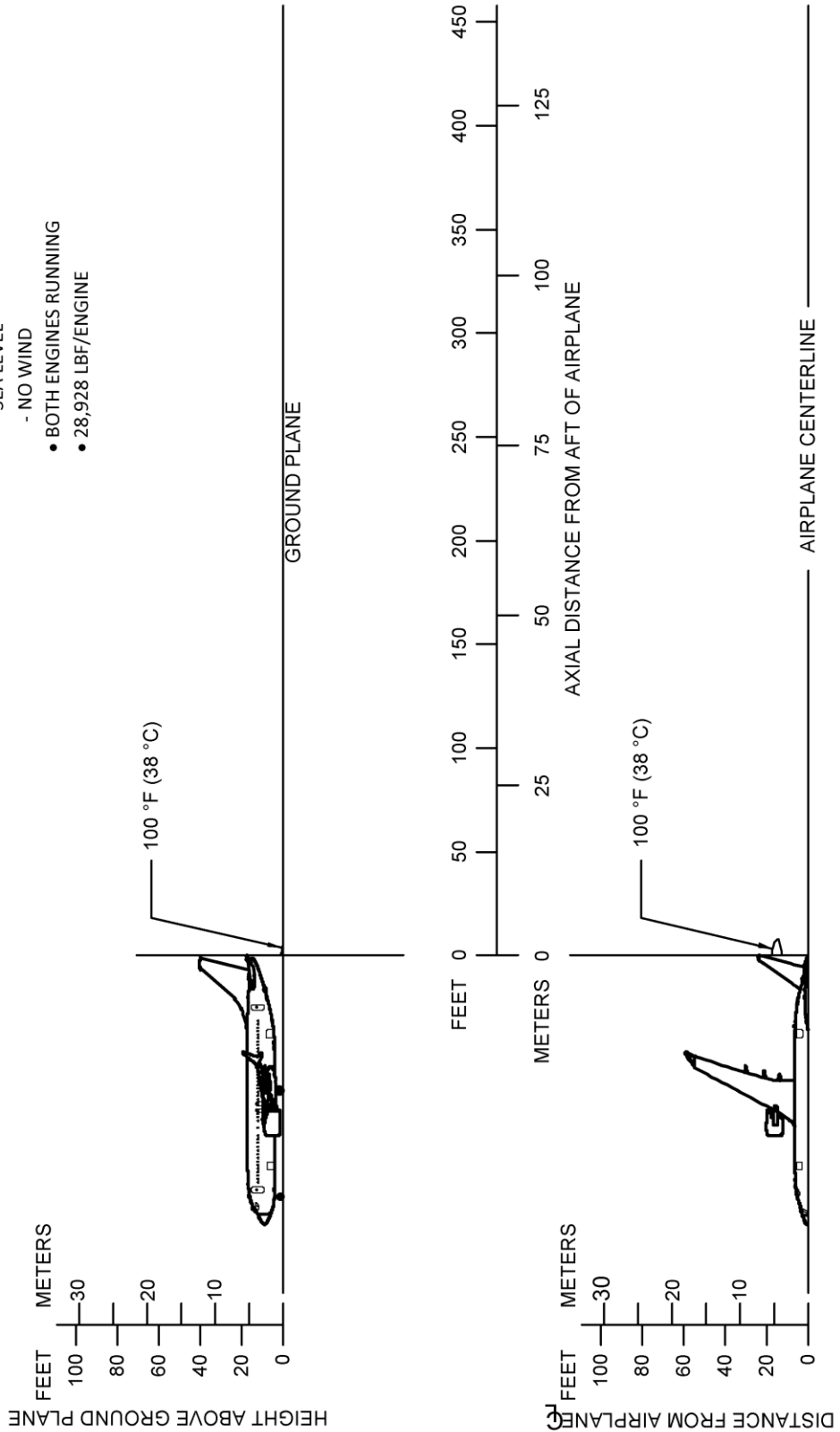

6.1.17 Jet Engine Exhaust Velocity Contours - Idle Thrust: Model 737-9

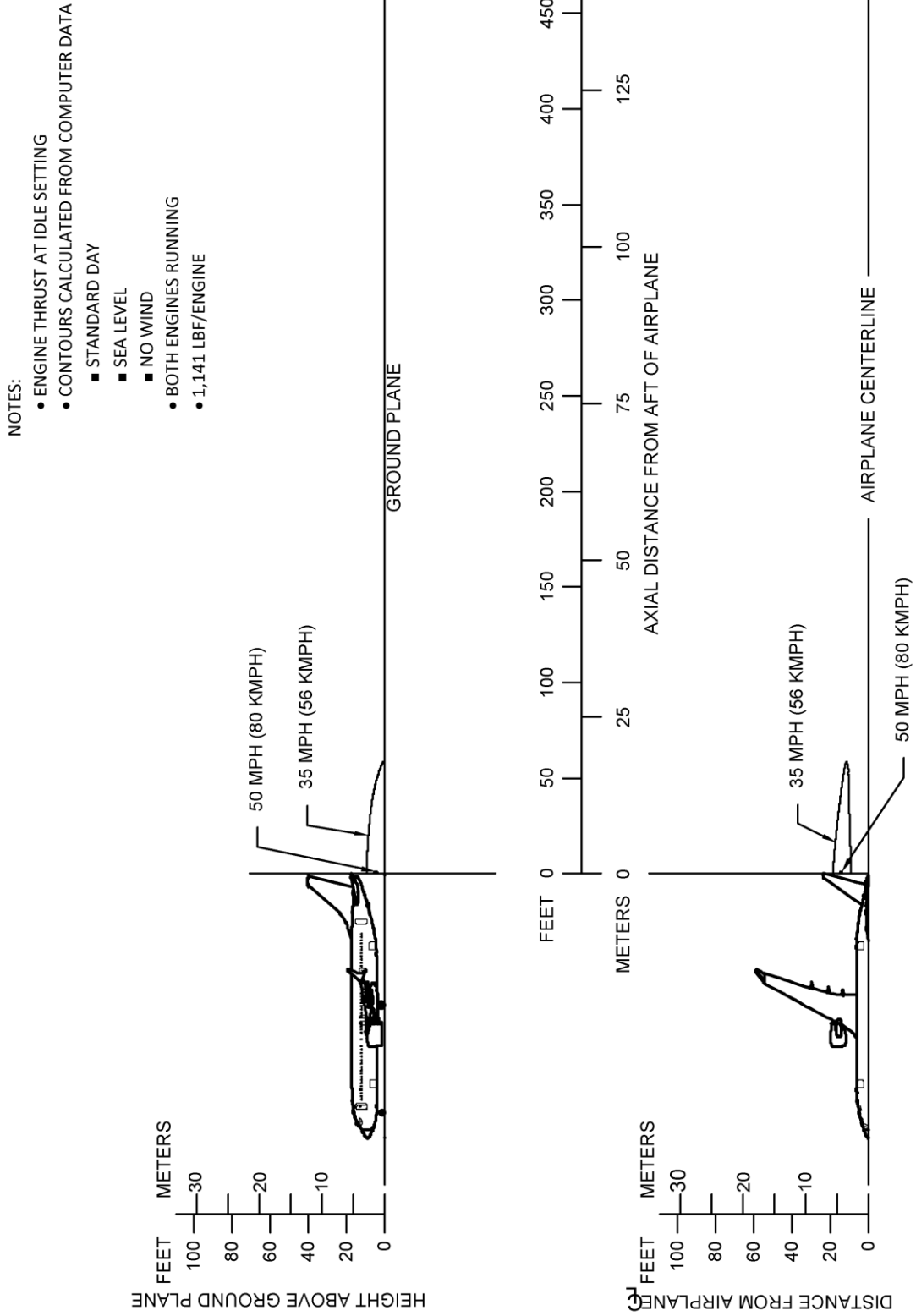

6.1.18 Jet Engine Exhaust Velocity Contours - Breakaway Thrust / 0% Slope / Both Engines / MTW: Model 737-9

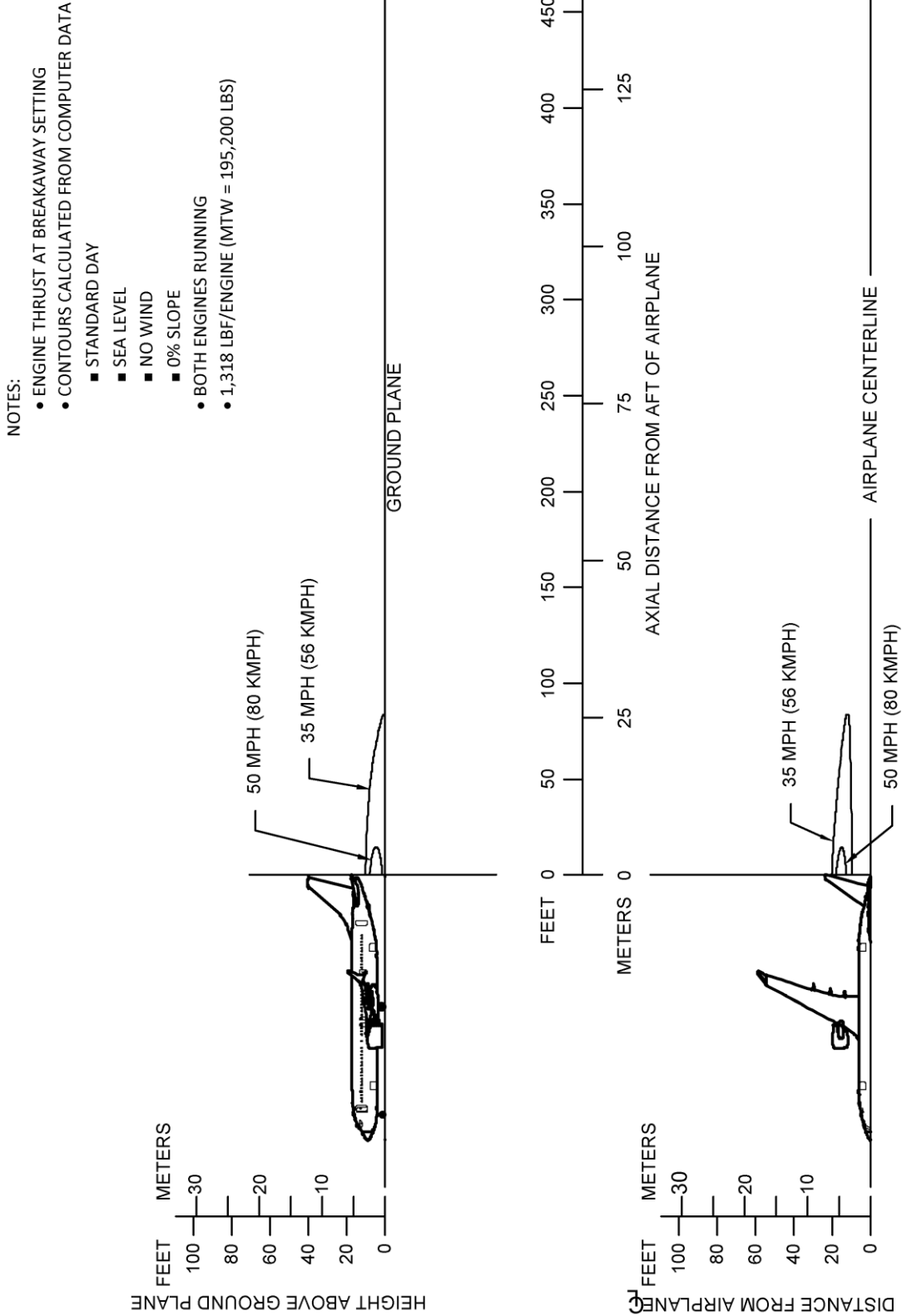

6.1.19 Jet Engine Exhaust Velocity Contours - Breakaway Thrust / 1% Slope / Both Engines / MTW: Model 737-9

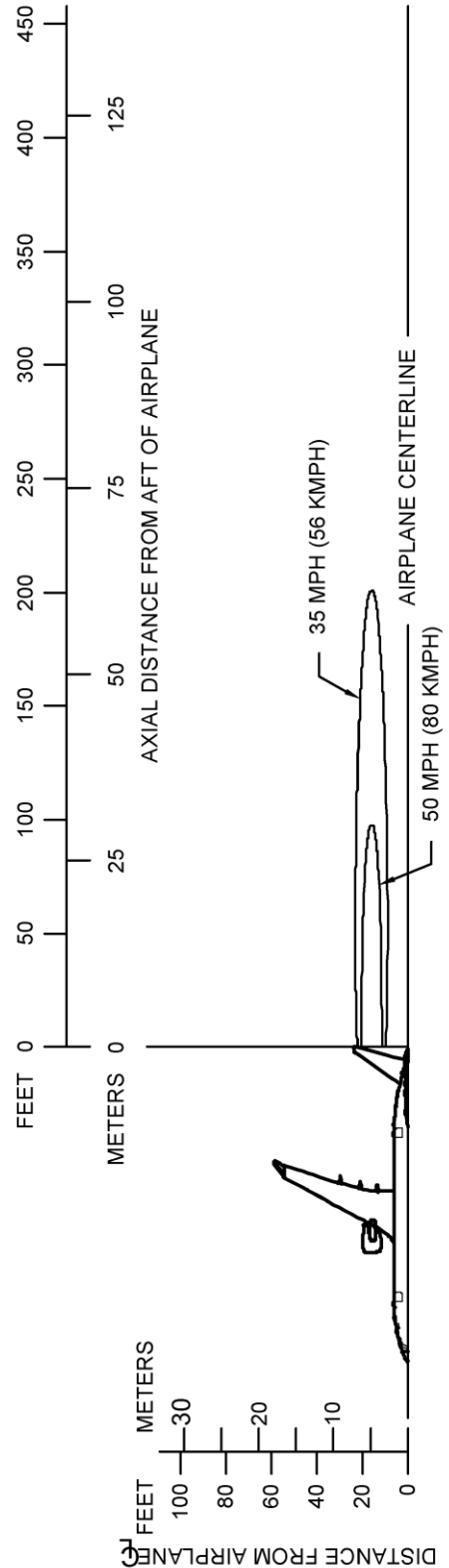
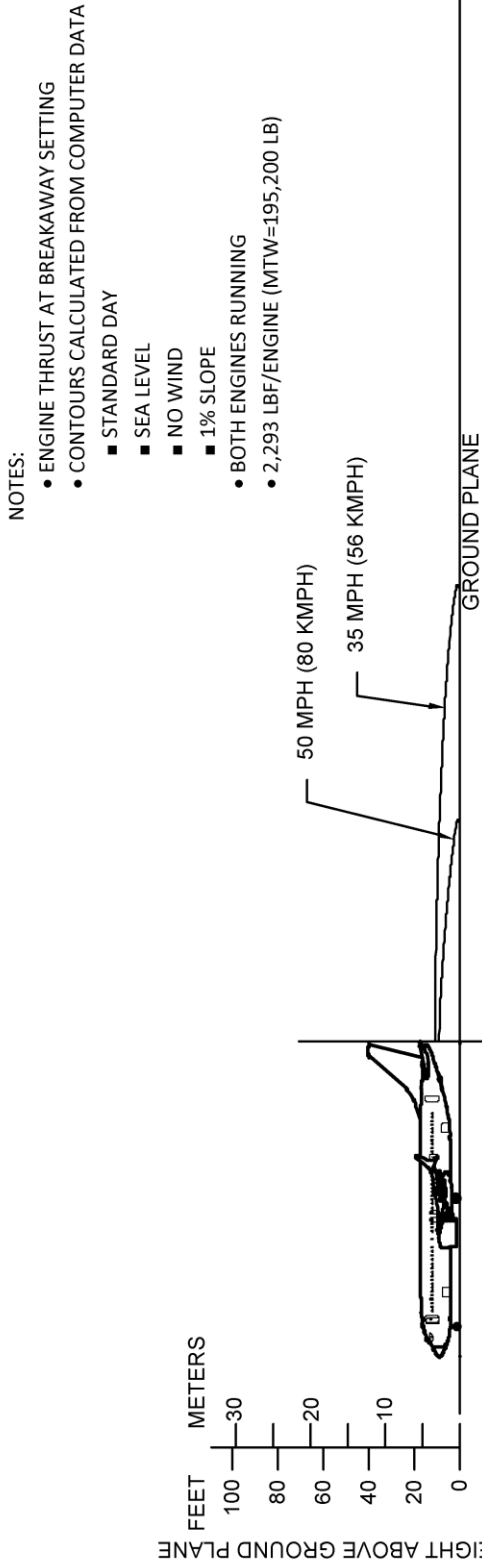

6.1.20 Jet Engine Exhaust Velocity Contours - Breakaway Thrust / 0% Slope / Single Engine / MTW: Model 737-9

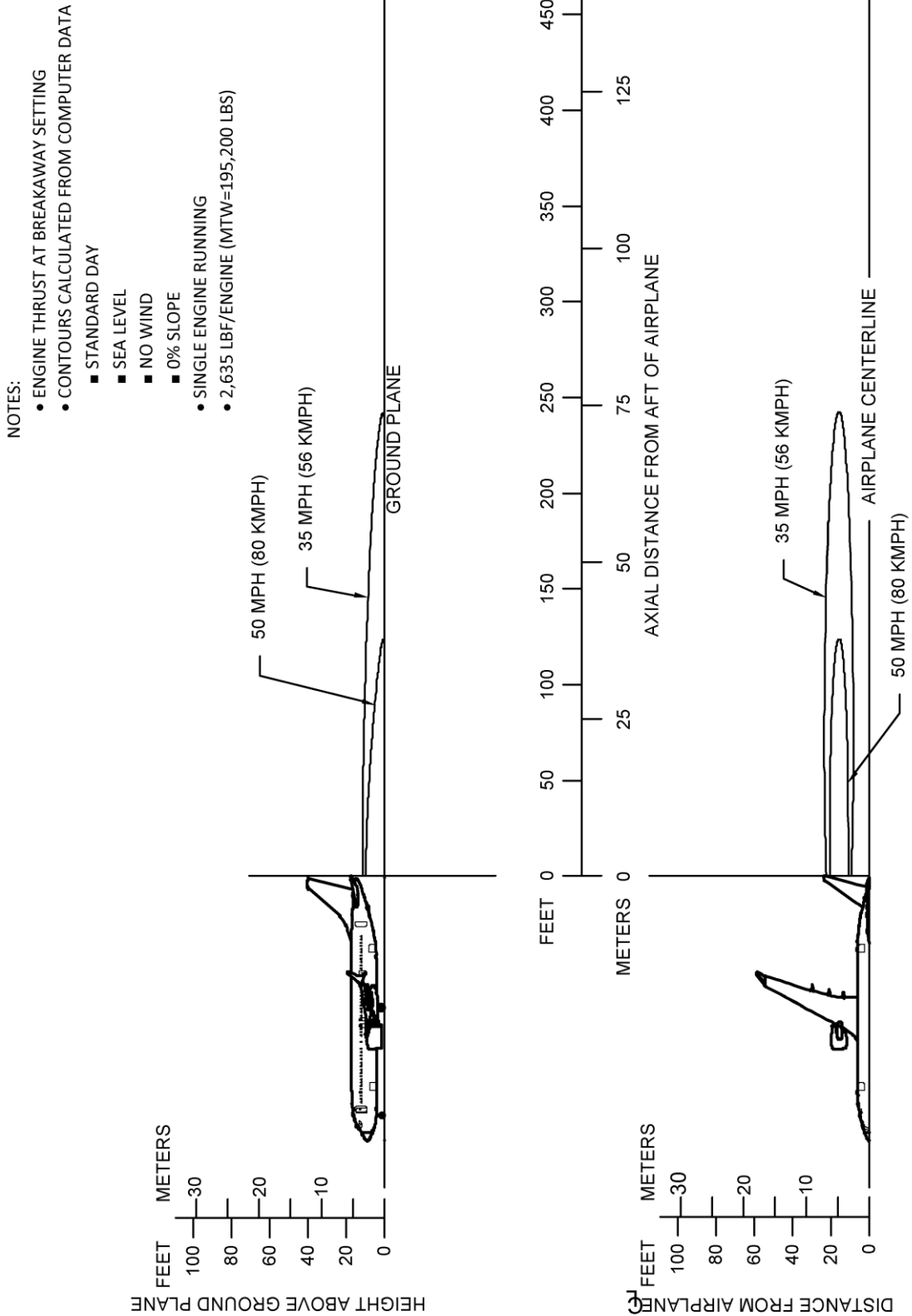

6.1.21 Jet Engine Exhaust Velocity Contours - Breakaway Thrust / 0% Slope / Single Engine / MLW: Model 737-9

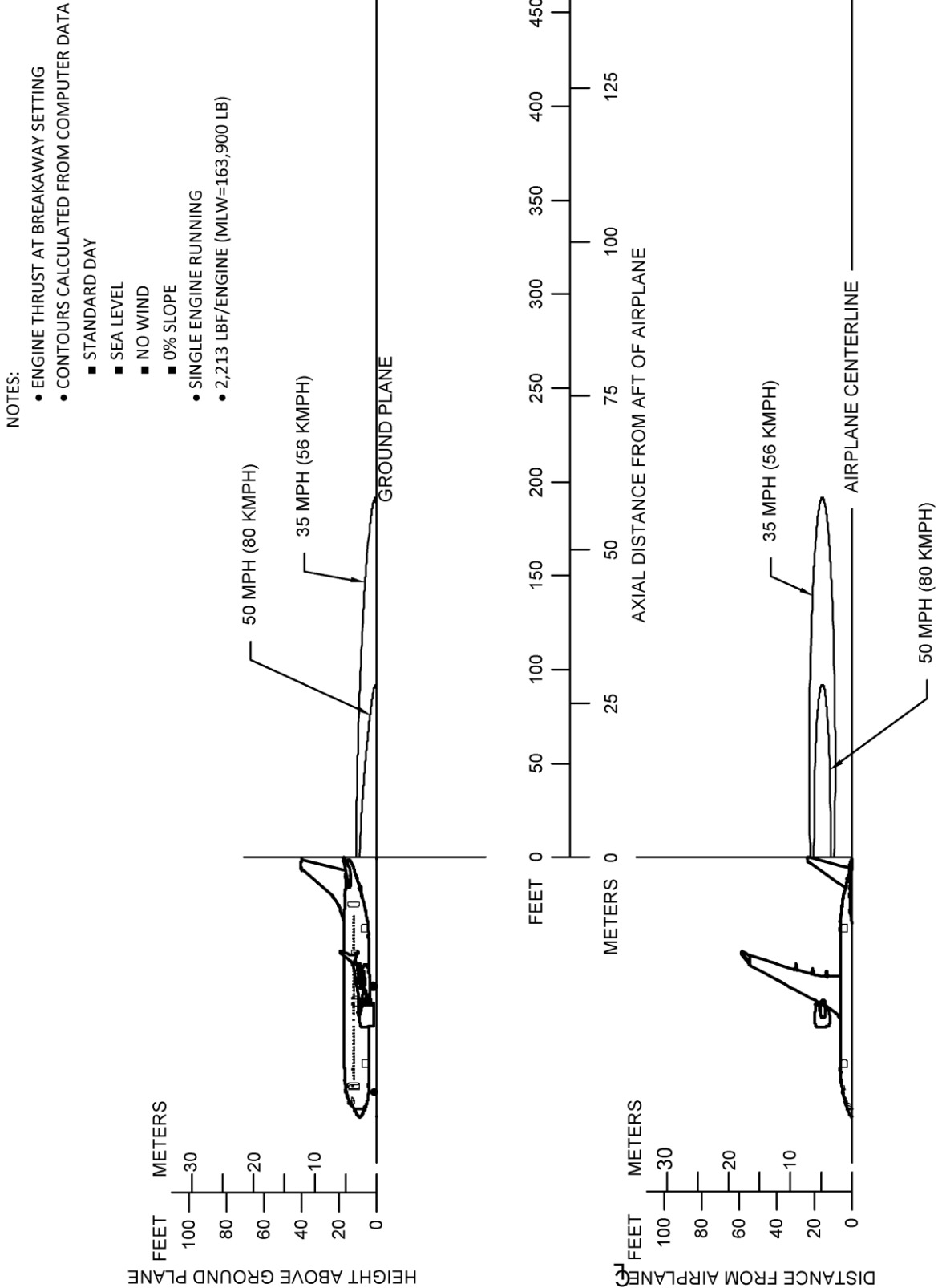

6.1.22 Jet Engine Exhaust Velocity Contours - Takeoff Thrust: Model 737-9

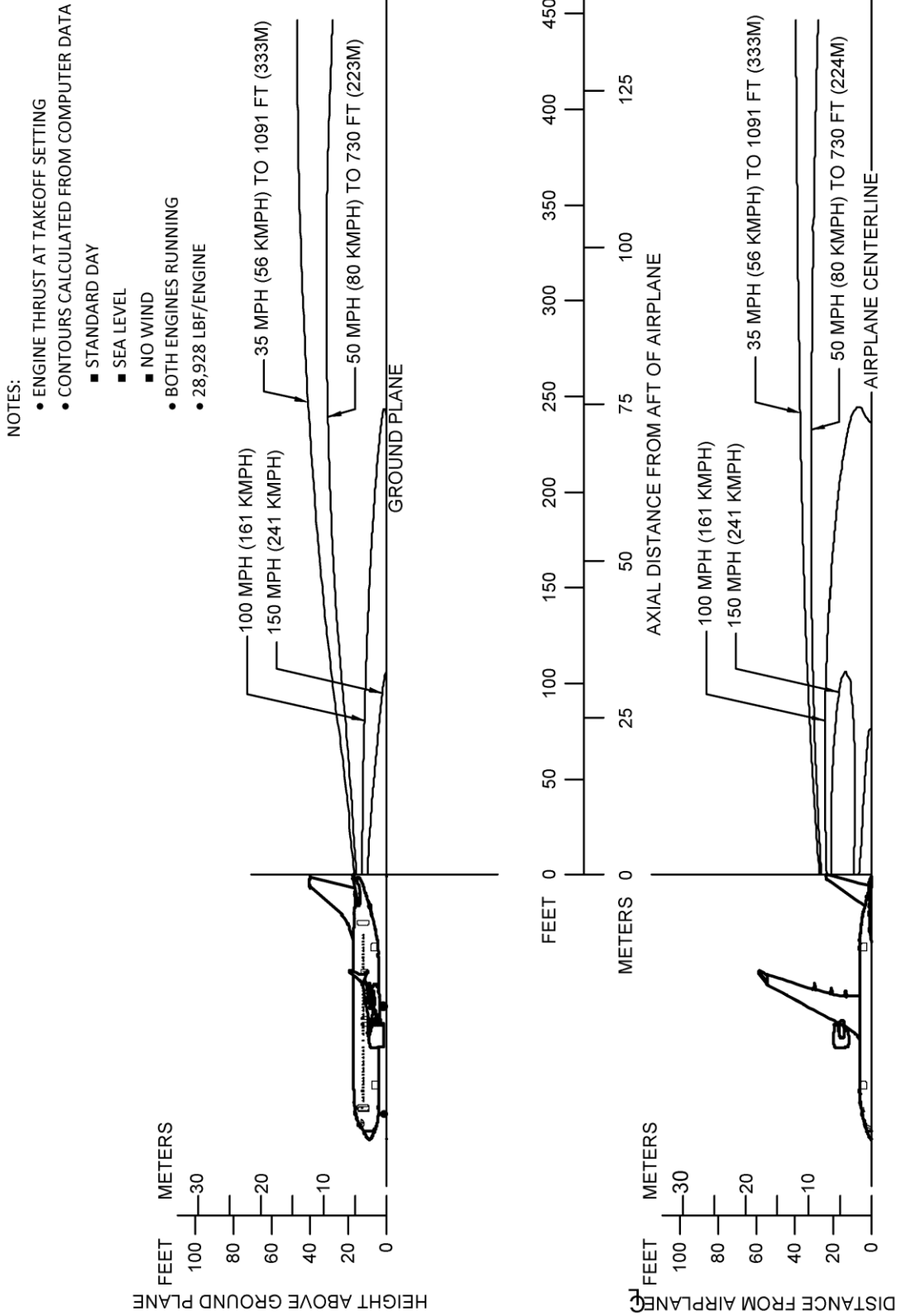

**6.1.23 Jet Engine Exhaust Temperature Contours – Idle/Breakaway Thrust:
Model 737-9**

Temperature contours for idle/breakaway power conditions are not shown as the maximum temperature aft of the 737-9 is predicated to be less than 100° F (38° C) for standard day conditions of 59° F (15° C).

6.1.24 Jet Engine Exhaust Temperature Contours – Takeoff Thrust: Model 737-9

- NOTES:
- ENGINE THRUST AT TAKEOFF SETTING
 - CONTOURS CALCULATED FROM COMPUTER DATA
 - STANDARD DAY
 - SEA LEVEL
 - NO WIND
 - BOTH ENGINES RUNNING
 - 28,928 LBF/ENGINE

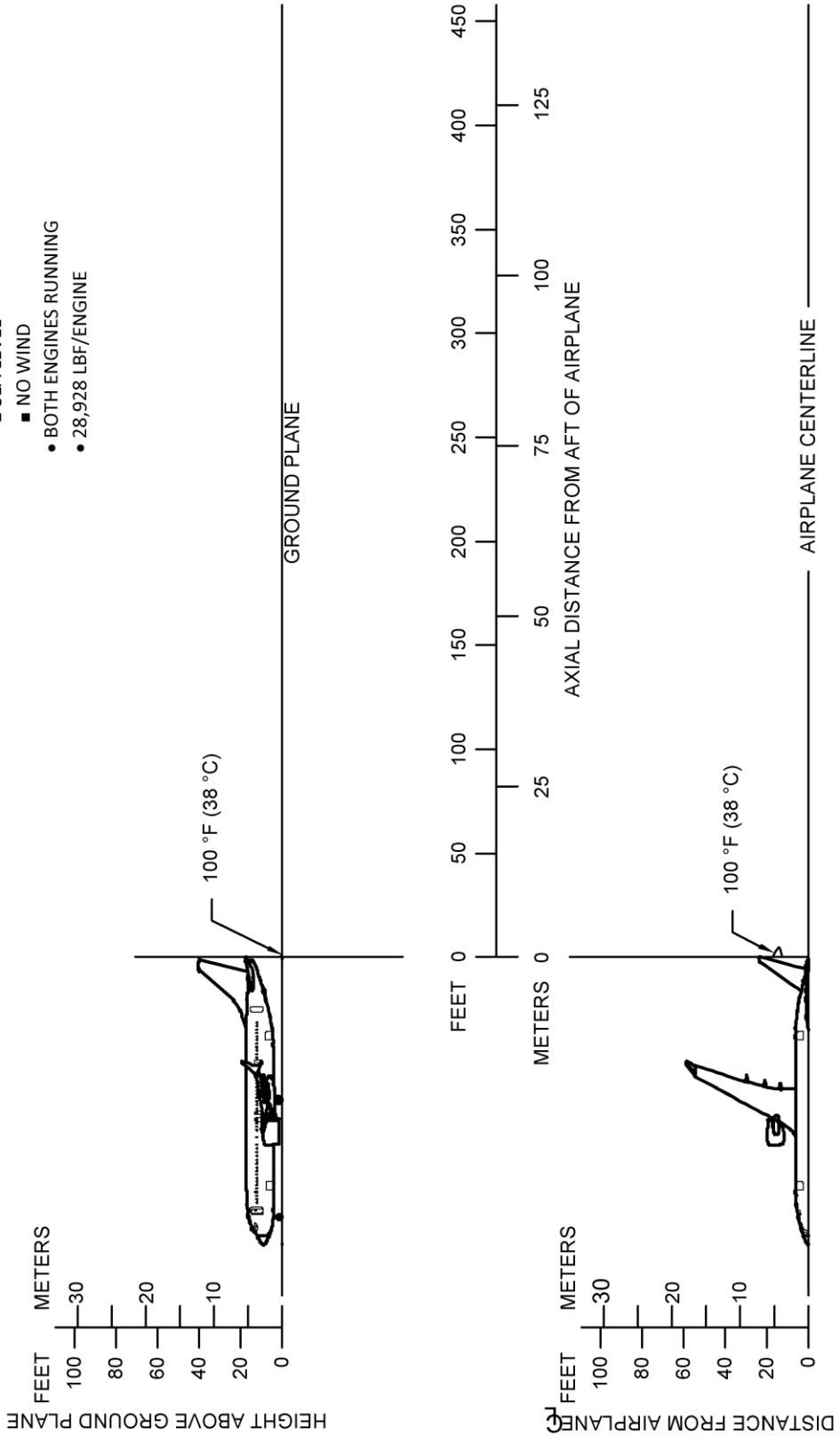

6.2 AIRPORT AND COMMUNITY NOISE

Airport noise is of major concern to the airport and community planner. The airport is a major element in the community's transportation system and, as such, is vital to its growth. However, the airport must also be a good neighbor, and this can be accomplished only with proper planning. Since aircraft noise extends beyond the boundaries of the airport, it is vital to consider the impact on surrounding communities. Many means have been devised to provide the planner with a tool to estimate the impact of airport operations. Too often they oversimplify noise to the point where the results become erroneous. Noise is not a simple subject; therefore, there are no simple answers.

The cumulative noise contour is an effective tool. However, care must be exercised to ensure that the contours, used correctly, estimate the noise resulting from aircraft operations conducted at an airport.

The size and shape of the single-event contours, which are inputs into the cumulative noise contours, are dependent upon numerous factors. They include the following:

1. Operational Factors
 - a. Aircraft Weight - Aircraft weight is dependent on distance to be traveled, en route winds, payload, and anticipated aircraft delay upon reaching the destination.
 - b. Engine Power Settings - The rates of ascent and descent and the noise levels emitted at the source are influenced by the power setting used.
 - c. Airport Altitude - Higher airport altitude will affect engine performance and thus can influence noise.
2. Atmospheric Conditions-Sound Propagation
 - a. Wind - With stronger headwinds, the aircraft can take off and climb more rapidly relative to the ground. Also, winds can influence the distribution of noise in surrounding communities.
 - b. Temperature and Relative Humidity - The absorption of noise in the atmosphere along the transmission path between the aircraft and the ground observer varies with both temperature and relative humidity.
3. Surface Condition-Shielding, Extra Ground Attenuation (EGA)
 - a. Terrain - If the ground slopes down after takeoff or up before landing, noise will be reduced since the aircraft will be at a higher altitude above ground. Additionally, hills, shrubs, trees, and large buildings can act as sound buffers.

All these factors can alter the shape and size of the contours appreciably. To demonstrate the effect of some of these factors, estimated noise level contours for two different

operating conditions are shown below. These contours reflect a given noise level upon a ground level plane at runway elevation.

Condition 1

Landing	Takeoff
Maximum Structural Landing Weight	Maximum Design Takeoff Weight
10-knot Headwind	Zero Wind
3° Approach	84 °F
84 °F	Humidity 15%
Humidity 15%	

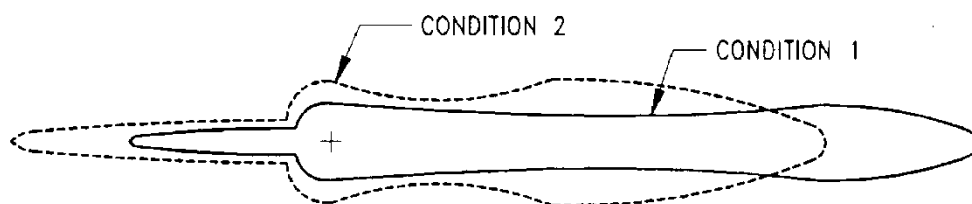

Condition 2

Landing	Takeoff
85% of Maximum Structural Landing Weight	80% of Maximum Design Takeoff Weight
10-knot Headwind	10-knot Headwind
3° Approach	59 °F
59 °F	Humidity 70%
Humidity 70%	

As indicated from these data, the contour size varies substantially with operating and atmospheric conditions. Most aircraft operations are, of course, conducted at less than maximum design weights because average flight distances are much shorter than maximum aircraft range capability and average load factors are less than 100%. Therefore, in developing cumulative contours for planning purposes, it is recommended that the airlines serving a particular city be contacted to provide operational information.

In addition, there are no universally accepted methods for developing aircraft noise contours or for relating the acceptability of specific zones to specific land uses. It is therefore expected that noise contour data for particular aircraft and the impact assessment methodology will be changing. To ensure that the best currently available information of

this type is used in any planning study, it is recommended that it be obtained directly from the Office of Environmental Quality in the Federal Aviation Administration in Washington, D.C.

It should be noted that the contours shown herein are only for illustrating the impact of operating and atmospheric conditions and do not represent the single-event contour of the family of aircraft described in this document. It is expected that the cumulative contours will be developed as required by planners using the data and methodology applicable to their specific study.

7.0 PAVEMENT DATA

7.1 GENERAL INFORMATION

A brief description of the pavement charts that follow will help in their use for airport planning. Each airplane configuration is depicted with a minimum range of five loads imposed on the main landing gear to aid in interpolation between the discrete values shown. All curves for any single chart represent data based on rated loads and tire pressures considered normal and acceptable by current aircraft tire manufacturer's standards. Tire pressures, where specifically designated on tables and charts, are at values obtained under loaded conditions as certificated for commercial use.

Section 7.2 presents basic data on the landing gear footprint configuration, maximum design taxi loads, and tire sizes and pressures.

Maximum pavement loads for certain critical conditions at the tire-to-ground interface are shown in Section 7.3, with the tires having equal loads on the struts.

Pavement requirements for commercial airplanes are customarily derived from the static analysis of loads imposed on the main landing gear struts. The charts in Section 7.4 are provided in order to determine these loads throughout the stability limits of the airplane at rest on the pavement. These main landing gear loads are used as the point of entry to the pavement design charts, interpolating load values where necessary.

The flexible pavement design curves based on the US Army Corp of Engineers Method and the rigid pavement curves based on the Portland Cement Association Design Method are no longer provided in Sections 7.5 and 7.7. Refer to the State's design standards for pavement design requirements. For US airports, refer to FAA Advisory Circular (AC) 150/5320-6, "Pavement Design" and pavement design program FAARFIELD for flexible and rigid pavement design requirements.

The Load Classification Number (LCN) curves are no longer provided in section 7.6 and 7.8 since the LCN system for reporting pavement strength is obsolete, being replaced by the ICAO recommended ACN/PCN system in 1983. For questions regarding the LCN system contact Boeing Airport Compatibility Engineering:

AirportCompatibility@boeing.com

The ACN/PCN system (Section 7.10) as referenced in ICAO Annex 14, "Aerodromes," 3rd Edition, July 1999, provides a standardized international airplane/pavement rating system replacing the various S, T, TT, LCN, AUW, ISWL, etc., rating systems used throughout the world. ACN is the Aircraft Classification Number and PCN is the Pavement Classification Number. An aircraft having an ACN equal to or less than the PCN can operate on the pavement subject to any limitation on the tire pressure. Numerically, the ACN is two times the derived single-wheel load expressed in thousands of kilograms, where the derived single wheel load is defined as the load on a single tire inflated to 181 psi (1.25 MPa) that would have the same pavement requirements as the aircraft.

Computationally, the ACN/PCN system uses the PCA program PDILB for rigid pavements and S-77-1 for flexible pavements to calculate ACN values. The method of pavement evaluation is left up to the airport with the results of their evaluation presented as follows:

PCN	PAVEMENT TYPE	SUBGRADE CATEGORY	TIRE PRESSURE CATEGORY	EVALUATION METHOD
	R = Rigid	A = High	W = No Limit	T = Technical
	F = Flexible	B = Medium	X = To 254 psi (1.75 MPa)	U = Using Aircraft
		C = Low	Y = To 181 psi (1.25 MPa)	
		D = Ultra Low	Z = To 73 psi (0.5 MPa)	

ACN values for flexible pavements are calculated for the following four subgrade categories:

Code A - High Strength - CBR 15

Code B - Medium Strength - CBR 10

Code C - Low Strength - CBR 6

Code D - Ultra Low Strength - CBR 3

ACN values for rigid pavements are calculated for the following four subgrade categories:

Code A - High Strength, $k = 550 \text{ pci (150 MN/m}^3\text{)}$

Code B - Medium Strength, $k = 300 \text{ pci (80 MN/m}^3\text{)}$

Code C - Low Strength, $k = 150 \text{ pci (40 MN/m}^3\text{)}$

Code D - Ultra Low Strength, $k = 75 \text{ pci (20 MN/m}^3\text{)}$

7.2 LANDING GEAR FOOTPRINT

7.2.1 Landing Gear Footprint: All Models

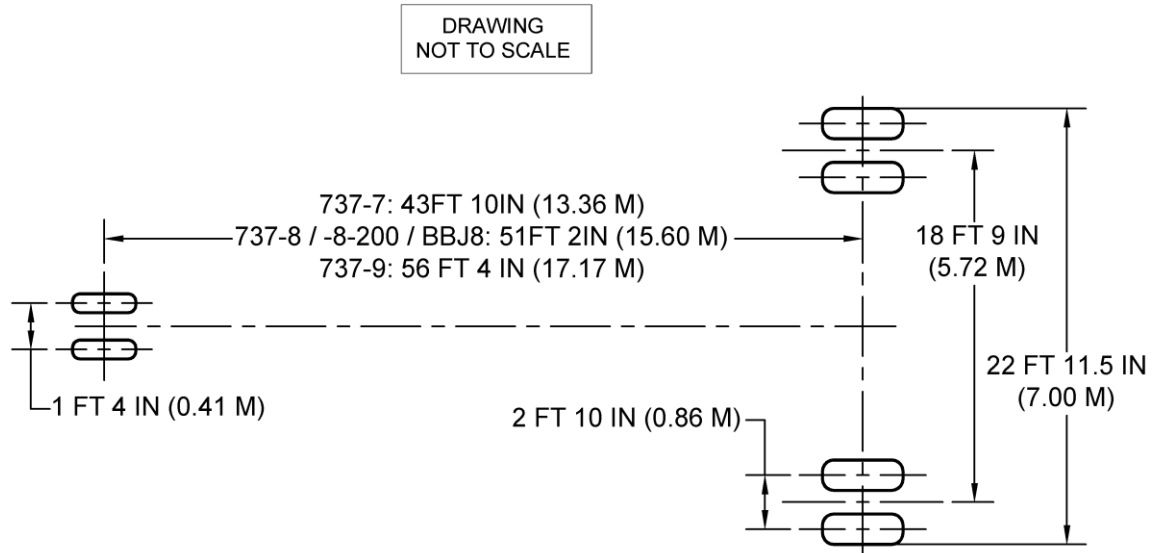

	UNITS	737-7	737-8 / 8-200 / BBJ MAX 8	737-9
MAXIMUM DESIGN	LB	177,500	181,700	195,200
TAXI WEIGHT	KG	80,512	82,417	88,541
NOSE GEAR	IN	27 x 7.75 R 15	27 x 7.75 R 15	27 x 7.75 R 15
TIRE SIZE		12 PR	12 PR	12 PR
NOSE GEAR	PSI	205	190	170
TIRE PRESSURE	MPa	1.41	1.31	1.17
MAIN GEAR	IN	H44.5 x 16.5 R 21	H44.5 x 16.5 R 21	H44.5 x 16.5 R 21
TIRE SIZE		30 PR	30 PR	32 PR
MAIN GEAR	PSI	205	210	230
TIRE PRESSURE	MPa	1.41	1.45	1.59

7.3 MAXIMUM PAVEMENT LOADS

7.3.1 Maximum Pavement Loads: All Models

V_{NG} = MAXIMUM VERTICAL NOSE GEAR GROUND LOAD AT MOST FORWARD CENTER OF GRAVITY

V_{MG} = MAXIMUM VERTICAL MAIN GEAR GROUND LOAD AT MOST AFT CENTER OF GRAVITY

H = MAXIMUM HORIZONTAL GROUND LOAD FROM BRAKING

NOTE: ALL LOADS CALCULATED USING AIRPLANE MAXIMUM DESIGN TAXI WEIGHT

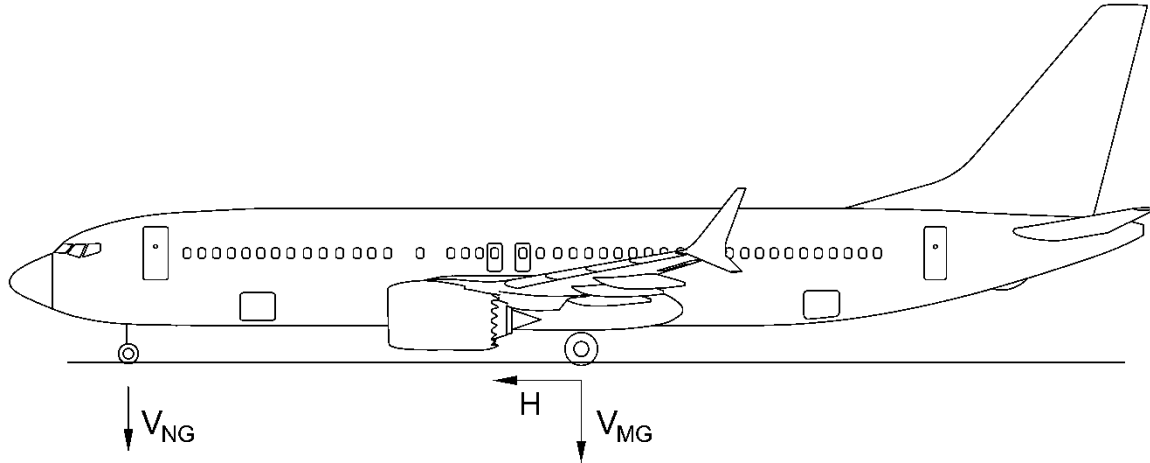

AIRPLANE MODEL	UNITS	MAX DESIGN TAXI WEIGHT	V_{NG}		V_{MG} PER STRUT AT MAX LOAD AT STATIC AFT C.G.	H PER STRUT	
			STATIC AT MOST FWD C.G.	STATIC + BRAKING 10 FT/SEC ² DECEL		STEADY BRAKING 10 FT/SEC ² DECEL	AT INSTANTANEOUS BRAKING ($\mu = 0.8$)
737-7	LB	18,918	30,637	82,866	27,566	66,293	18,918
	KG	8,581	13,897	37,587	12,504	30,070	8,581
737-8 / -8-200 / BBJ MAX 8	LB	181,700	15,807	26,129	84,791	28,218	67,833
	KG	82,417	7,170	11,852	38,461	12,799	30,769
737-9	LB	195,200	15,514	25,639	91,868	30,315	73,494
	KG	88,541	7,037	11,630	41,671	13,751	33,336

7.4 LANDING GEAR LOADING ON PAVEMENT

7.4.1 Landing Gear Loading on Pavement: Model 737-7

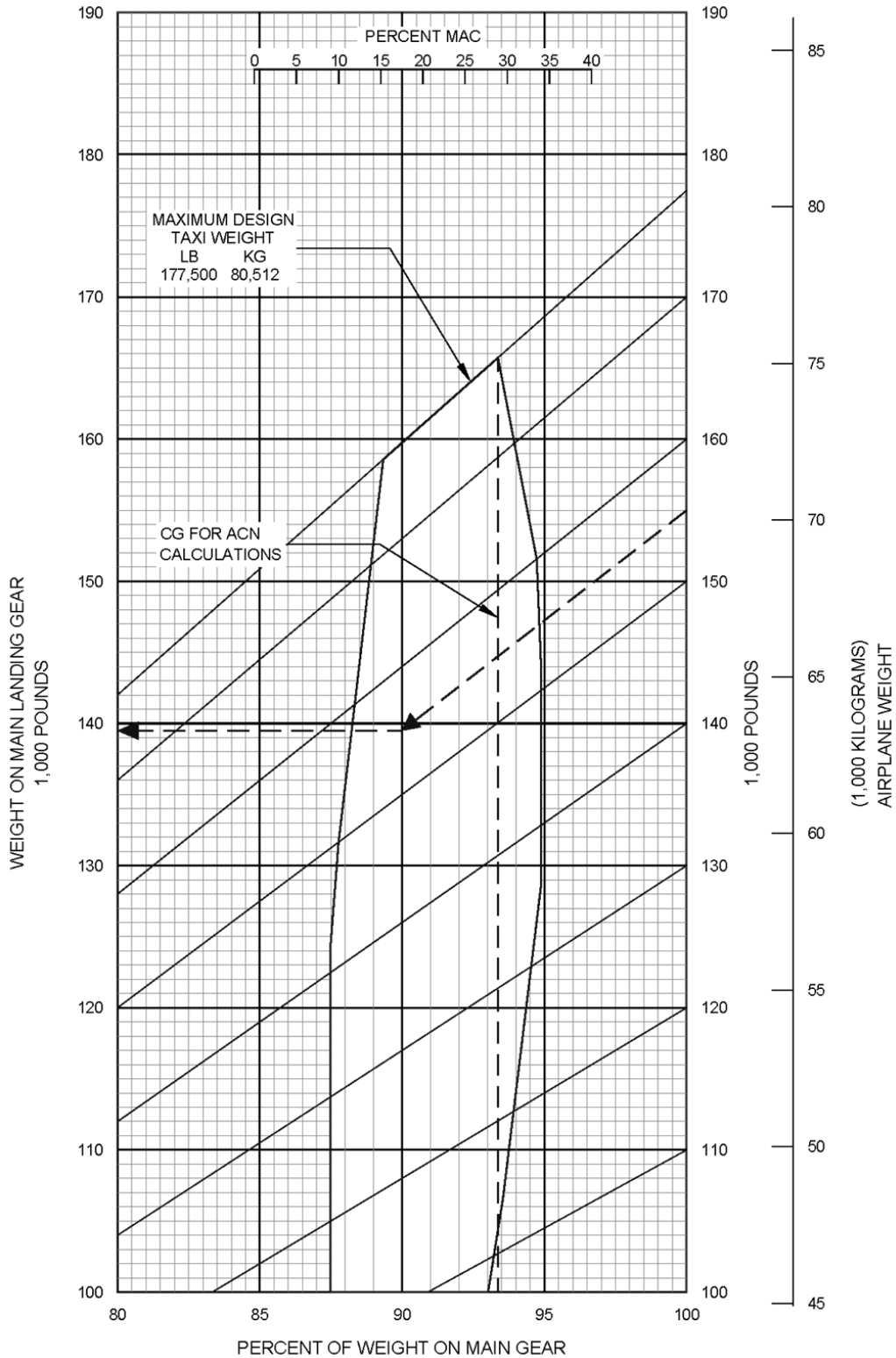

7.4.2 Landing Gear Loading on Pavement: Model 737-8 / -8-200 / BBJ MAX 8

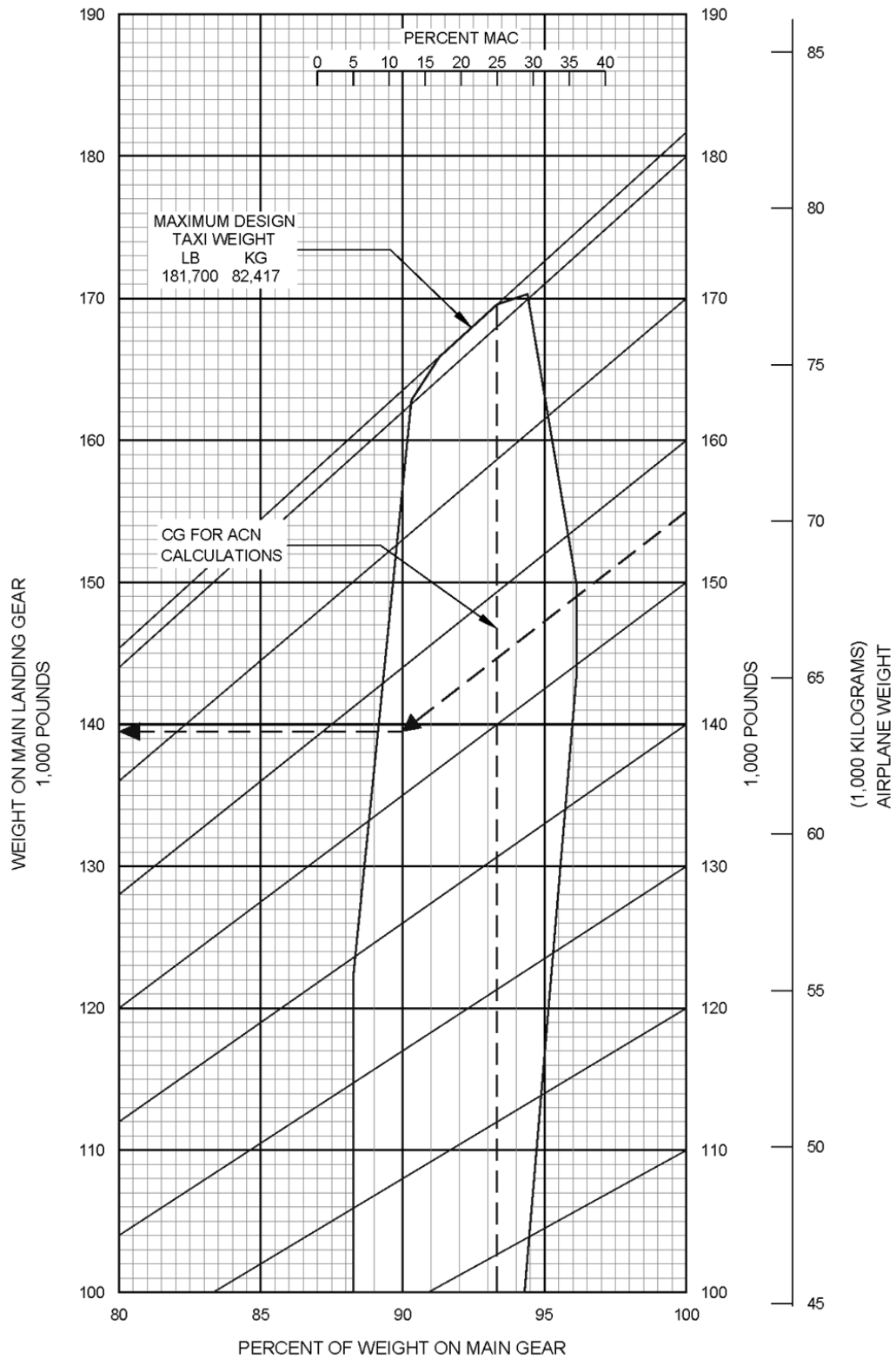

7.4.3 Landing Gear Loading on Pavement: Model 737-9

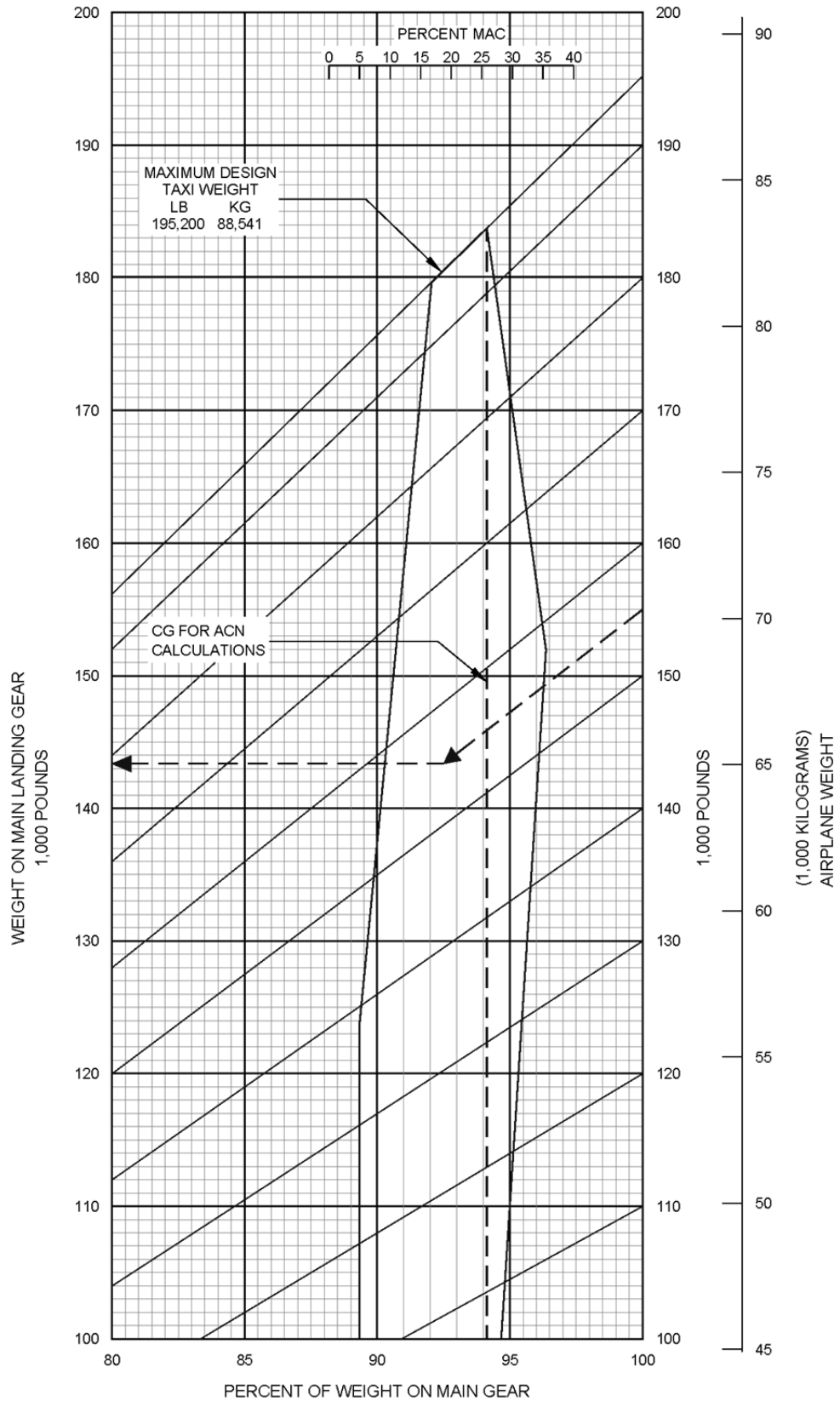

7.5 FLEXIBLE PAVEMENT REQUIREMENTS - FAA DESIGN METHOD

For the flexible pavement design refer to the FAA AC 150/5320-6 "Pavement Design" and pavement design program FAARFIELD. Both are available on the FAA website:

<http://www.faa.gov/airports/engineering>

7.6 FLEXIBLE PAVEMENT REQUIREMENTS - LCN CONVERSION

The Load Classification Number (LCN) curves are no longer provided in section 7.6 and 7.8 since the LCN system for reporting pavement strength is obsolete, being replaced by the ICAO recommended ACN/PCN system in 1983. For questions regarding the LCN system contact Boeing Airport Compatibility Engineering:

AirportCompatibility@boeing.com

**7.7 RIGID PAVEMENT REQUIREMENTS - PORTLAND CEMENT
ASSOCIATION DESIGN METHOD**

The rigid pavement requirements based on the Portland Cement Association method are no longer provided.

7.8 RIGID PAVEMENT REQUIREMENTS - LCN CONVERSION

The Load Classification Number (LCN) curves are no longer provided in section 7.6 and 7.8 since the LCN system for reporting pavement strength is obsolete, being replaced by the ICAO recommended ACN/PCN system in 1983. For questions regarding the LCN system contact Boeing Airport Compatibility Engineering:

AirportCompatibility@boeing.com

7.9 RIGID PAVEMENT REQUIREMENTS - FAA DESIGN METHOD

For the rigid pavement design refer to the FAA AC 150/5320-6 "Pavement Design" and pavement design program FAARFIELD. Both are available on the FAA website:

<http://www.faa.gov/airports/engineering>

7.10 ACN/PCN REPORTING SYSTEM - FLEXIBLE AND RIGID PAVEMENTS

To determine the ACN of an aircraft on flexible or rigid pavement, both the aircraft gross weight and the subgrade strength category must be known. In the chart in Section 7.10.1, for an aircraft with gross weight of 140,000 lb and high subgrade strength, the flexible pavement ACN is 33. In Section 7.10.2, for the same gross weight and subgrade strength, the rigid pavement ACN is 38.

The following table provides ACN data in tabular format similar to the one used by ICAO in the “Aerodrome Design Manual Part 3, Pavements”. If the ACN for an intermediate weight between maximum taxi weight and the empty weight of the aircraft is required, Figures 7.10.1 through 7.10.2 should be consulted.

AIRCRAFT TYPE	MAXIMUM TAXI WEIGHT MINIMUM WEIGHT *[1] LB (KG)	LOAD ON ONE MAIN GEAR LEG (%)	TIRE PRESSURE PSI (MPa)	ACN FOR RIGID PAVEMENT SUBGRADES - MN/m ³				ACN FOR FLEXIBLE PAVEMENT SUBGRADES - CBR			
				HIGH 150	MEDIUM 80	LOW 40	ULTRA LOW 20	HIGH 15	MEDIUM 10	LOW 6	ULTRA LOW 3
737-7	177,500 (81,512)	46.69	205 (1.41)	50	53	55	57	44	46	51	56
	95,000 (43,091)			24	25	27	28	21	22	23	27
737-8	181,700 (82,417)	46.67	210 (1.45)	52	54	57	59	45	48	53	58
	95,000 (43,091)			24	25	27	28	21	22	23	27
737-9	195,200 (88,541)	47.07	230 (1.59)	59	61	64	65	50	53	58	63
	95,000 (43,091)			25	26	28	29	22	22	24	27

*[1] Minimum weight used solely as a baseline for ACN curve generation.

7.10.1 Aircraft Classification Number - Flexible Pavement: Model 737-7

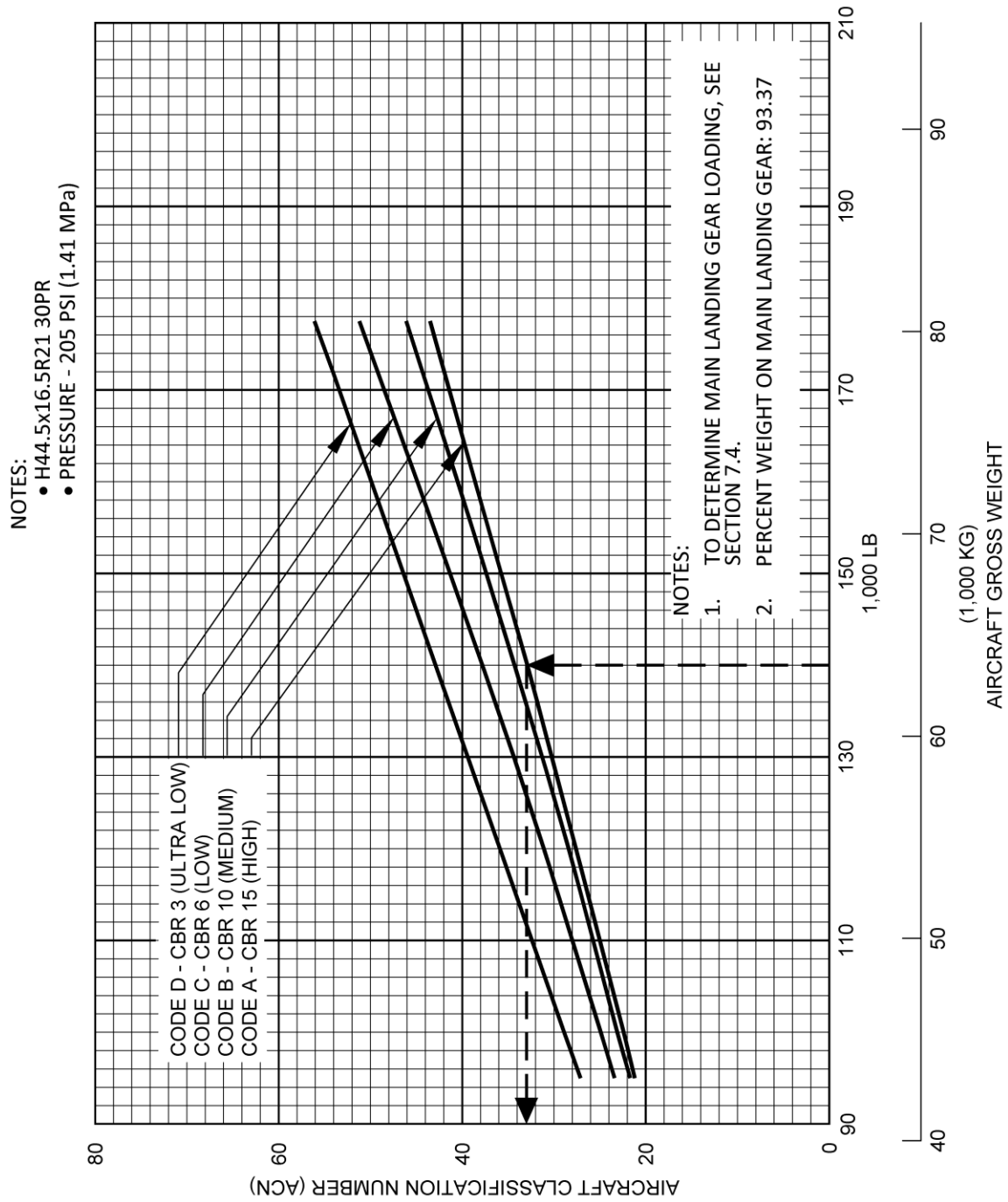

7.10.2 Aircraft Classification Number - Rigid Pavement: Model 737-7

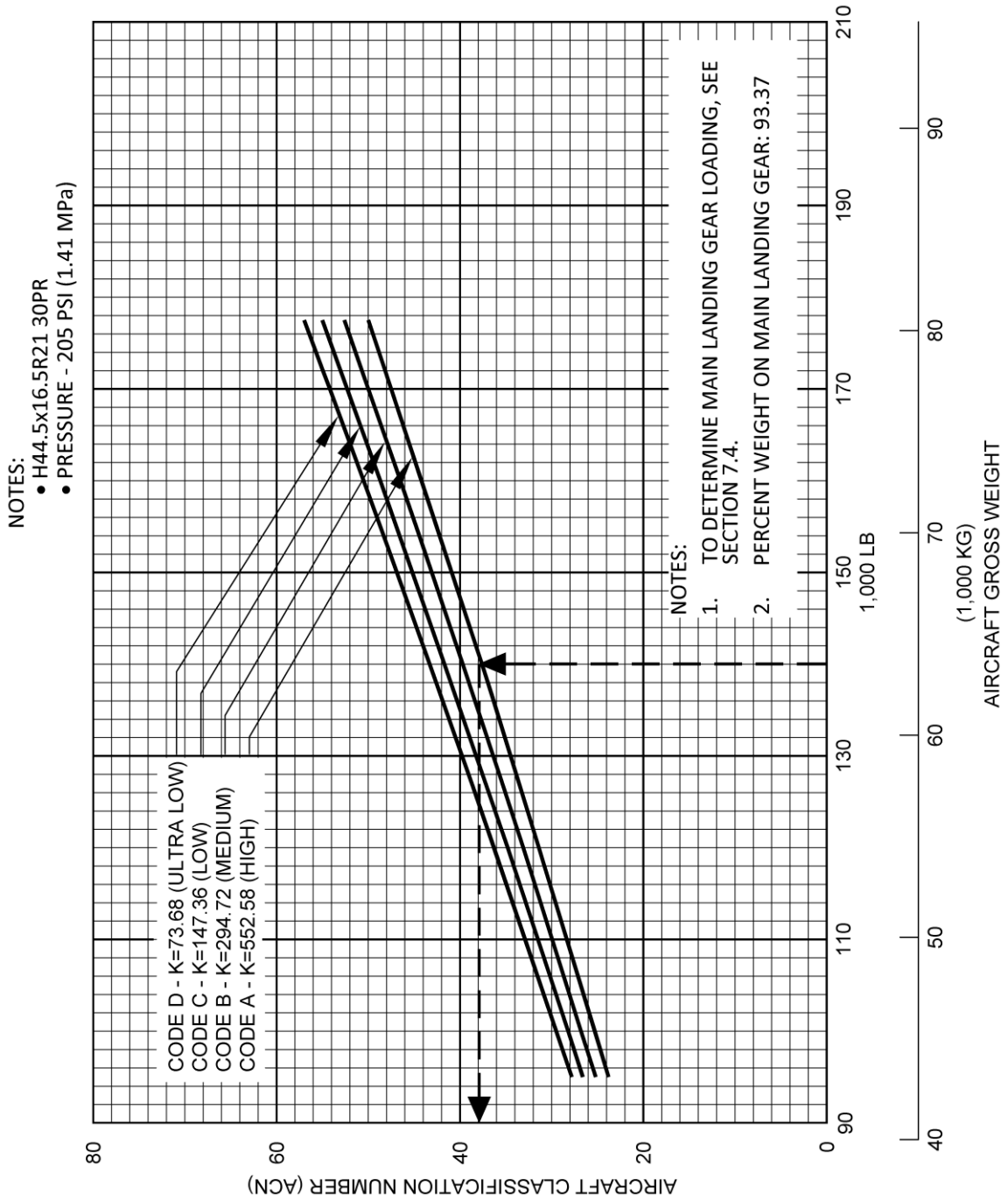

7.10.3 Aircraft Classification Number - Flexible Pavement: Model 737-8 / -8-200 / BBJ MAX 8

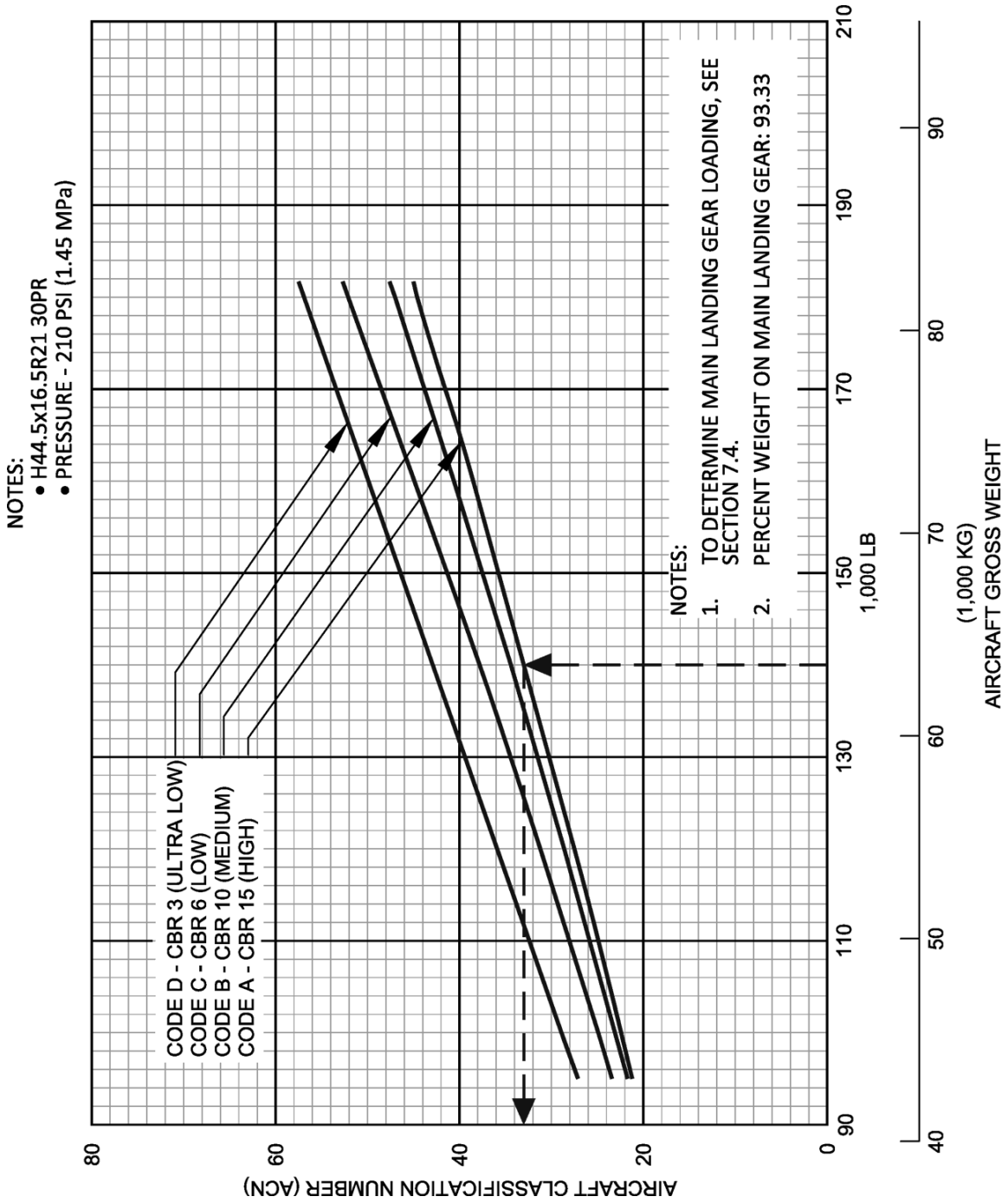

7.10.4 Aircraft Classification Number - Rigid Pavement: Model 737-8 / -8-200 / BBJ MAX 8

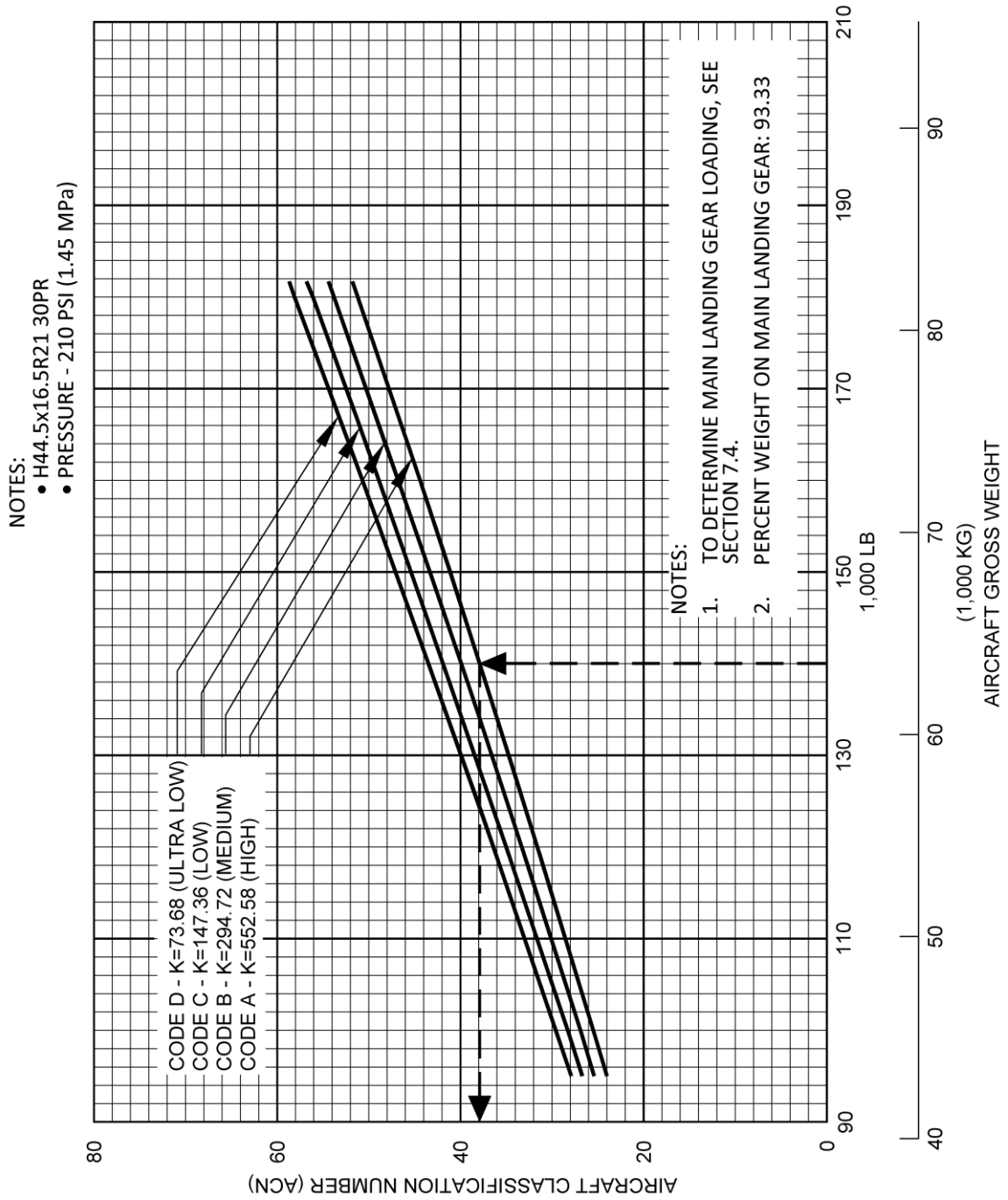

7.10.5 Aircraft Classification Number - Flexible Pavement: Model 737-9

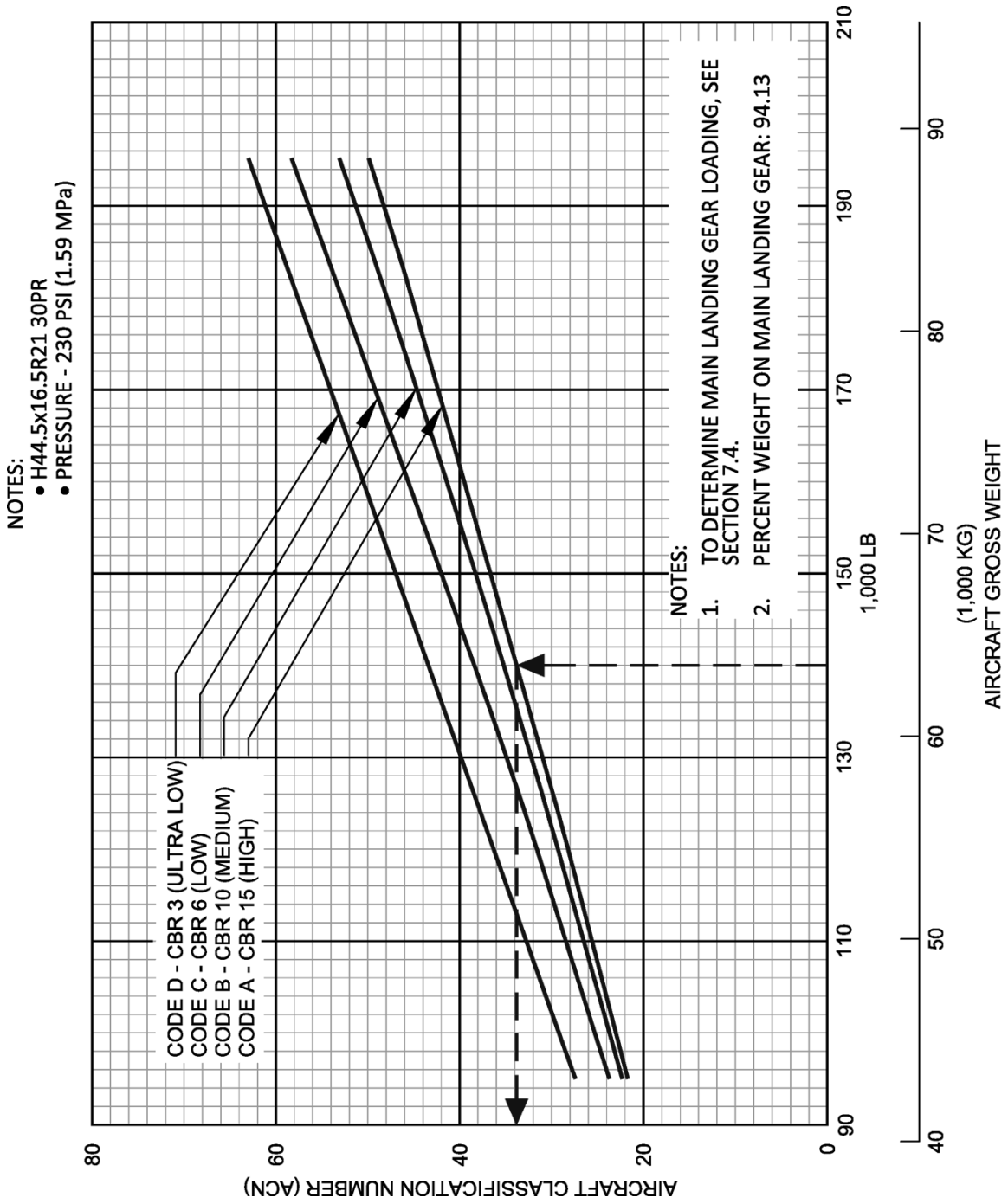

7.10.6 Aircraft Classification Number - Rigid Pavement: Model 737-9

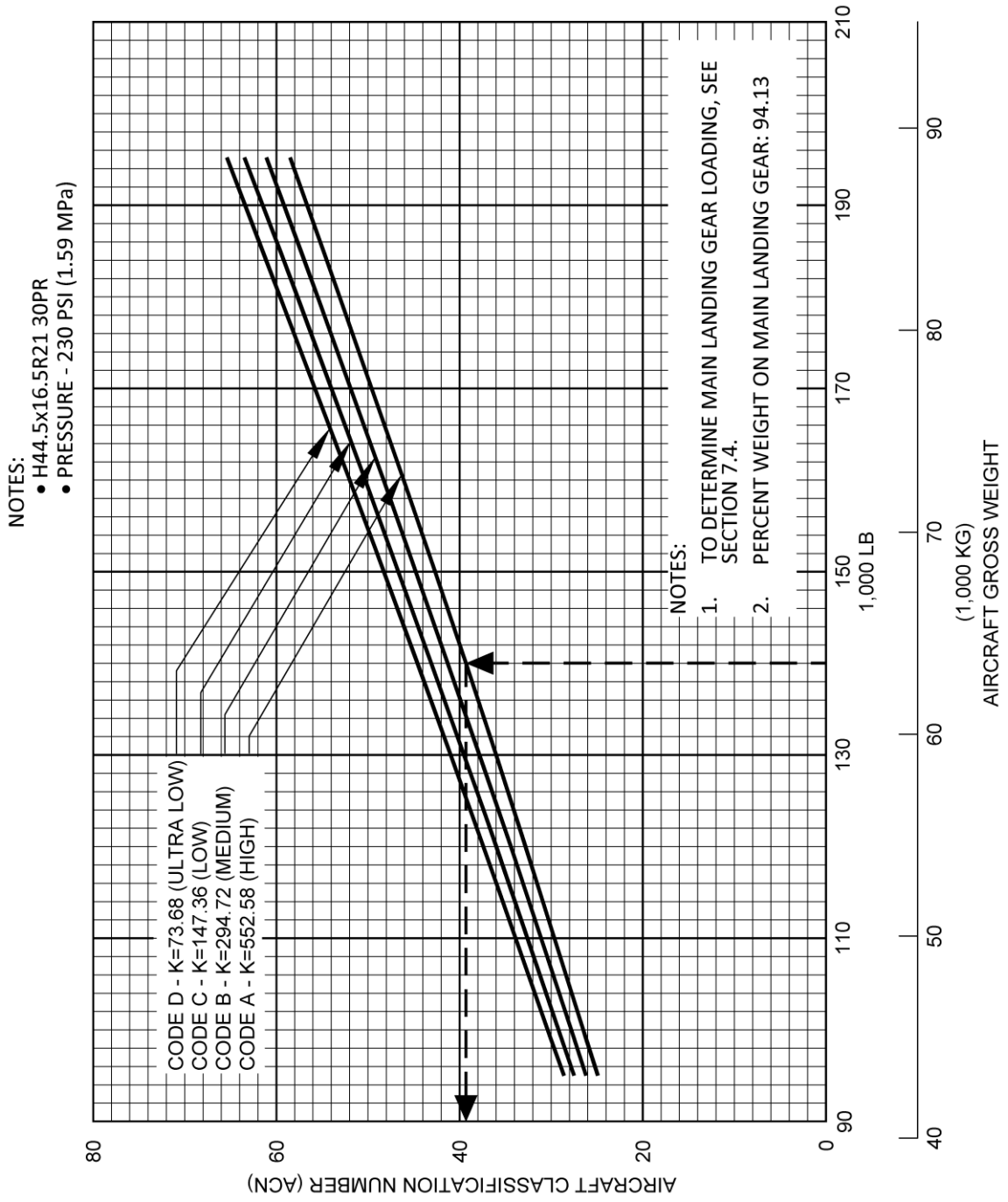

8.0 FUTURE 737 DERIVATIVE AIRPLANES

Boeing's philosophy is to evaluate the derivative potential of its airplanes to provide capabilities that maximize value to our customers.

Decisions to design and manufacture future derivatives of an airplane depend on many considerations, including customer requirements. Along with many other parameters, airport facilities are considered during the development of any future airplane.

9.0 SCALED 737 DRAWINGS

The drawings in the following pages show airplane plan view drawings, drawn to approximate scale as noted. The drawings may not come out to exact scale when printed or copied from this document. Printing scale should be adjusted when attempting to reproduce these drawings. Three-view drawing files of the 737 MAX airplane models, along with other Boeing airplane models, can be downloaded from the following website:

<http://www.boeing.com/airports>

9.1 MODEL 737-7

9.1.1 Scaled Drawings – 1:500: Model 737-7

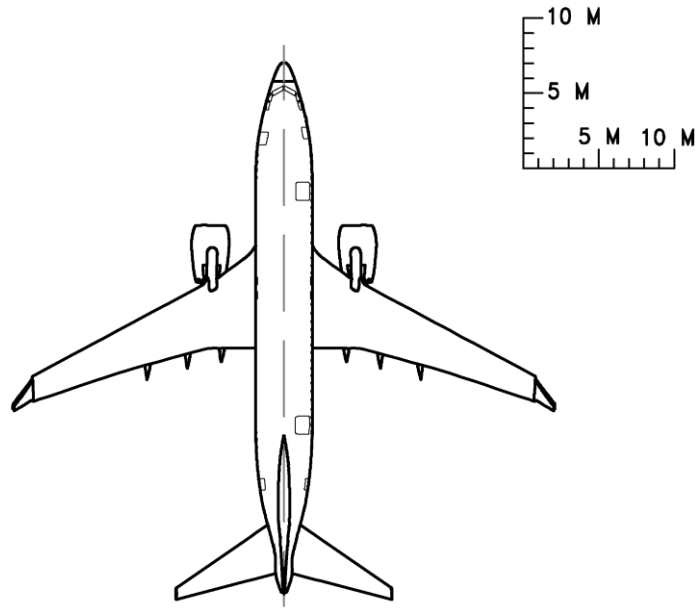

NOTE: WHEN PRINTING THIS DRAWING, MAKE SURE TO ADJUST FOR PROPER SCALING

9.2 MODEL 737-8

9.2.1 Scaled Drawings – 1:500: Model 737-8

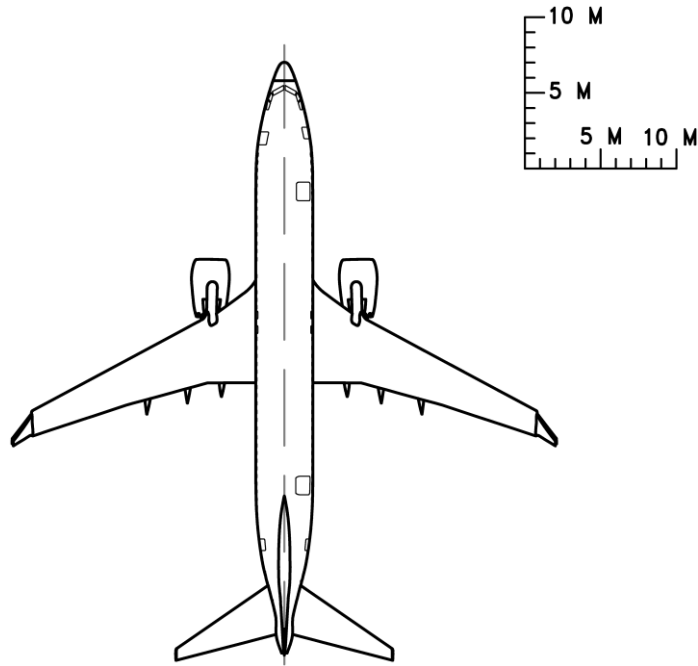

NOTE: WHEN PRINTING THIS DRAWING, MAKE SURE TO ADJUST FOR PROPER SCALING

9.3 MODEL 737-9

9.3.1 Scaled Drawings – 1:500: Model 737-9

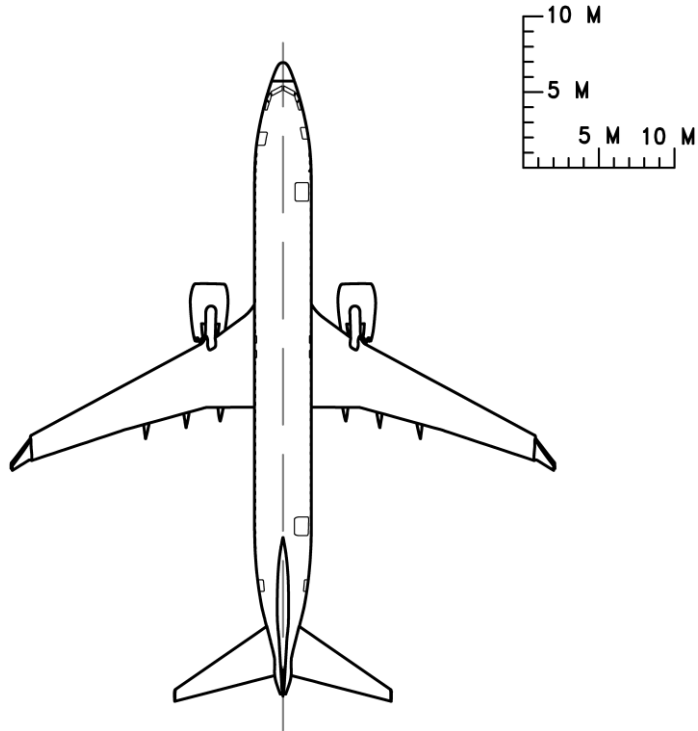

NOTE: WHEN PRINTING THIS DRAWING, MAKE SURE TO ADJUST FOR PROPER SCALING